

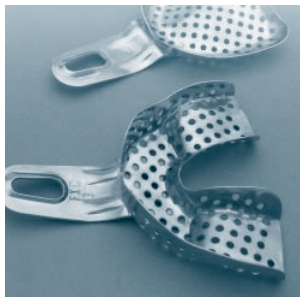

NÁSTROJE PRO STOMATOLOGII
INSTRUMENTS FOR DENTISTRY
DENTAL INSTRUMENTE

S T O M A T O L O G I E – D E N T I S T R Y

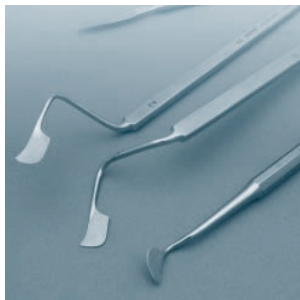

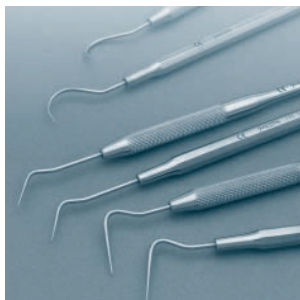
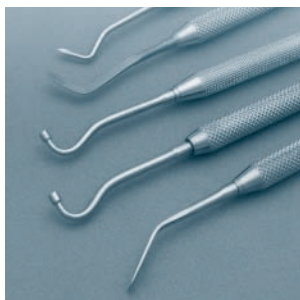
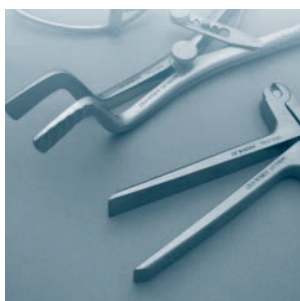
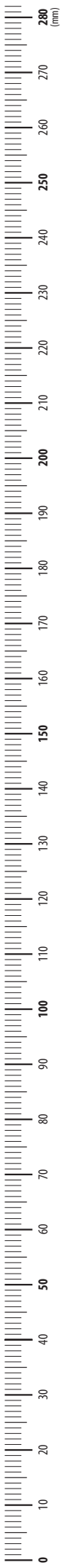

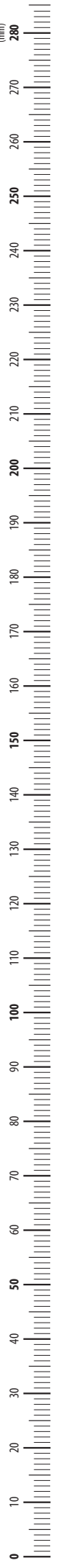



MEDIN, a.s.

Vlachovická 619
Nové Město na Moravě
CZ 592 31
Czech Republic
IČO 43378030
DIČ CZ43378030

CENTRÁLA

tel.: 566 684 111

PRODEJ ČESKÁ REPUBLIKA

tel.: 566 684 327
fax: 566 684 384
e-mail: prodej@medin.cz

PRODEJNA PRAHA

Jana Želivského 6
Praha 3
CZ 130 00
tel./fax: 222 592 334
mobil: 606 686 530

PRODEJ SLOVENSKÁ REPUBLIKA

tel.: +420 566 684 332
fax: +420 566 684 385
e-mail: export@medin.cz

EXPORT

phone: +420 566 684 336
fax: +420 566 684 385
e-mail: export@medin.cz

www.medin.cz



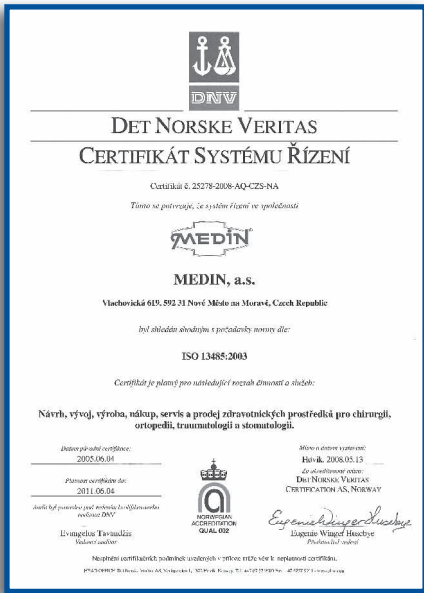

Certifikát EN ISO 13485
Certificate EN ISO 13485

CE 0434

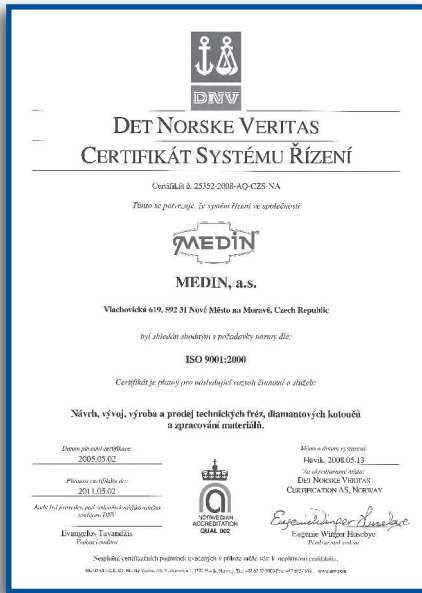

Certifikát ISO 9001
Certificate ISO 9001



Certifikát ISO 14001
Certificate ISO 14001

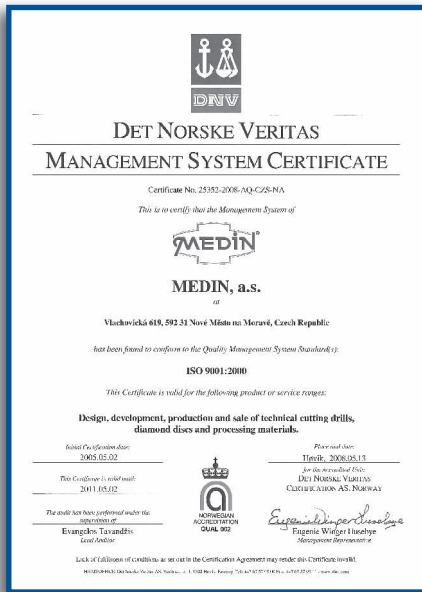

Akciová společnost MEDIN se sídlem v Nové Městě na Moravě zahájila činnost 4. 5. 1992 jako právní nástupce bývalého státního podniku Chirana Nové Město na Moravě.

MEDIN, a.s., je největší český výrobce nástrojů pro humánní lékařství ve všech hlavních oborech lékařských specializací včetně kostní chirurgie a implantátů pro traumatologii a ortopedii. Zároveň je největším českým výrobcem dentálních nástrojů jak ordinálních, tak rotačních.

Dlouholetá tradice výroby lékařských nástrojů, začínající již v roce 1949, vytvořila know-how umožňující dodávat výrobky vysoké kvality s ohledem na dosažení vysoké míry bezpečnosti odpovídající vysoké úrovni ochrany zdraví. Úroveň, kvalita a bezpečnost všech nástrojů je pečlivě posuzována. Akcent na kvalitu a bezpečnost nástrojů je tradičně zakotven ve firemní politice jakosti a strategii firmy. V kvalitě používá firma účinných postupů dle mezinárodních norem *ISO 9001 Systémy managementu kvality* a *ISO 13485 Systémy jakosti – Zdravotnické prostředky*, jejichž certifikáty jsou pravidelně obnovovány. Důležitou oblastí je splnění legislativních podmínek při uvádění výrobků na trh, zejména evropské direktivy Medical Device 93/42/EHS.

MEDIN, a.s., uplatňuje aktivní postoj k ochraně životního prostředí a praktickou činností směřuje k minimalizaci dopadů vlivů firemních činností na životní prostředí. Komplex výrobních, pomocných a administrativních prostor společnosti splňuje použitými technologiemi a energetickými zdroji přísná ekologická hlediska. Prostřednictvím profesně i odborně způsobilých pracovníků trvale udržuje šetrný vztah k životnímu prostředí. Environmentální management firmy je udržován v souladu s mezinárodní normou *ISO 14001 Systémy environmentálního managementu*.

MEDIN, the joint-stock company, having its headquarters in Nové Město na Moravě commenced its activity on May 4, 1992 as a legal successor of the former state-owned enterprise Chirana Nové Město na Moravě.

MEDIN, the joint-stock company, is the greatest Czech producer of instruments for human medicine in all main fields of medical specialisations, including the bone surgery and implants for traumatology and orthopaedics. It is also the biggest producer of surgery and rotary dental instruments.

A long standing tradition of surgical instruments production, founded as early as 1949, has established a know-how that enables to provide products of high quality and safety corresponding to high level of health protection. The standards, quality and safety of all instruments are carefully evaluated. The quality and safety of the instruments are traditionally anchored in the company's quality policy and company's strategy. We use the effective procedures according to the International Standard *ISO 9001 – Systems of quality management* and *ISO 13485 Quality Systems – Medical Instruments* whose certificates are regularly renewed. It is also very important to follow the legislative conditions when launching the products on the market, mainly the European Directive Medical Devices 93/42/EEC.

MEDIN, the joint-stock company, cares about the environment actively and minimises the impacts of the company's activity on the environment. The complex of production, auxiliary and administration buildings of the company meets the strict environmental aspects with the applied technologies and energy sources.

We permanently keep a considerate relation with our environment through our professionals and specialists. The Environmental management of the company is in conformity with *ISO 14001 – Systems of environmental management*.



Die Aktiengesellschaft MEDIN mit dem Sitz in Nové Město na Moravě eröffnete am 4. 5. 1992 als rechtlicher Nachfolger des ehemaligen Staatsunternehmens Chirana Nové Město na Moravě ihre Tätigkeit.

MEDIN, a.s. ist der größte tschechische Hersteller von Instrumenten für die Humanmedizin in allen Hauptanwendungsgebieten der medizinischen Spezialisierungen einschließlich Knochenchirurgie und Implantate für die Traumatologie und Orthopädie. Gleichzeitig ist MEDIN der größte tschechische Produzent von zahnmedizinischen Instrumenten sowohl für die Praxis- wie auch rotierenden Instrumente.

Die langjährige Tradition der Herstellung von medizintechnischen Instrumenten, bereits 1949 beginnend, stellte ein Know-how auf, das möglich macht, Produkte der Höchstqualität unter Berücksichtigung der Erreichung hoher Sicherheitsmaße zu liefern, die dem hohen Niveau des Gesundheitsschutzes entsprechen. Niveau, Qualität und Sicherheit aller Instrumente sind sorgfältig begutachtet. Der Akzent auf Qualität und Sicherheit der Instrumente ist in der Firmenpolitik von Qualität und

Firmenstrategie traditionell verankert. In der Qualität wendet die Firma ein wirkungsvolles Verfahren nach den internationalen Normen *ISO 9001 System des Qualitätsmanagementsystems* und *ISO 13485 Qualitätsmanagementsysteme – Medizinprodukte* an, deren Zertifikate regelmäßig erneuert werden. Ein wichtiger Bereich ist das Erfüllen der legislativen Bedingungen bei der Produkteinführung auf den Markt, insbesondere der europäischen Rechtsordnung *Medical Device 93/42/EEC*.

MEDIN, a.s., macht eine aktive Stellungnahme zum Umweltschutz geltend und in der praktischen Tätigkeit steuert sie zur Minimalisierung der Auswirkungen der Firmentätigkeit auf die Umwelt bei. Ein Komplex von Herstellungs-, Hilfs- und Verwaltungsbedingungen der Gesellschaft erfüllt mit den angewendeten Technologien und Energiequellen strenge ökologische Standpunkte. Mit Hilfe von professionellen und fachlich qualifizierten Mitarbeitern hält die Firma dauerhafte schonende Beziehungen zur Umwelt. Das Umweltmanagement der Firma ist in Übereinstimmung mit der internationalen Norm *ISO 14001 Umweltmanagementsysteme* gehalten.



A	Extrakce a chirurgie	Extraction and Surgery	Extraktion und Chirurgie	9–68
B	Diagnostika	Diagnostics	Diagnostik	69–74
C	Záchovná stomatologie	Restorative	Konservierende Behandlung	75–94
D	Parodontologie	Periodontia	Parodontologie	95–108
E	Ortodoncie	Orthodontics	Orthodontie	109–116
G	Laboratoř	Laboratory	Labor	117–134
D	Sterilizace a pomocné vybavení	Sterilization and Accessories	Sterilisation und Zubehör	135–148
	Číselný rejstřík	Numerical index	Zahleindex	149–166
	Jmenný rejstřík	Alphabetical index	Namenverzeichnis	167–174



KLEŠTĚ EXTRAČNÍ	EXTRACTION FORCEPS	ZAHNZANGEN	11–15
KLEŠTĚ ŠTÍPACÍ	BONE RONGEURS	HOHLMEISSELZANGEN	16–18
KLEŠTĚ ÚCHOPNÉ	GRASPING FORCEPS	HALTERZANGEN	19
PÁČIDLA	ELEVATORS	ELEVATOREN	20
PÁKY EXTRAČNÍ	ROOT ELEVATORS	WURZELHEBER	21–25
ŠKRABKY	RASPATORIES	RASPATORIEN	26
PILNÍKY	RASPS	FEILEN	27
DLÁTA	CHISELS	MEISSEL	28–29
KLADÍVKA	MALLETS	HÄMMER	30
HÁKY	HOOKS, RETRACTORS	HAKEN	31–36
CHRÁNIČE PRSTU	FINGER PROTECTORS	FINGERSCHÜTZER	37
ROZVĚRAČE ÚST	MOUTH RETRACTORS	MUNDSPERRER	37–38
LŽIČKY	BONE CURETTES, SPOONS	LÖFFEL	39–41
NÁSTROJE ŘEZNÉ	CUTTING INSTRUMENTS	OPERATIONSSKALPELLE	41–42
DRŽÁTKA SKALPELOVÝCH ČEPELEK	SCALPEL HANDLES	SKALPELLGRIFFE	43
SKALPELOVÉ ČEPELKY	SCALPEL BLADES	SKALPELLKLINGEN	44
SVORKY	CLAMPS, FORCEPS	KLEMMEN	45–49
JEHELCE	NEEDLE HOLDERS	NADELHALTER	50–53
ZAVADĚČE	INTRODUCERS	TAMPONSTOPFER	54
DLAHY DENTÁLNÍ	DENTAL PLATES	DENTALSCHIENUNGSPLATTEN	55
NŮŽKY	SCISSORS	SCHEREN	56–62
PINZETY	FORCEPS	PINZETTEN	63–68

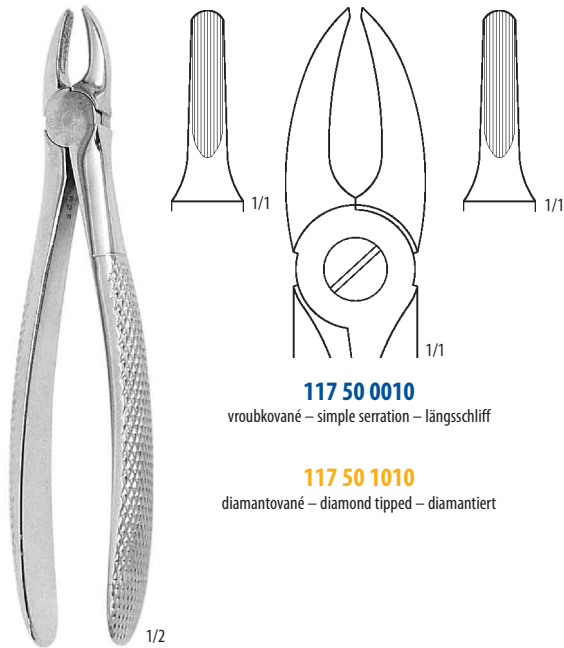

D2
 NA HORNÍ MALÉ REZÁKY
 FOR UPPER LATERALS
 FÜR OBERE KLEINE SCHNEIDEZÄHNE
 16,8 cm

117 50 0010

vroubkované – simple serration – längsschliff

117 50 1010

diamantované – diamond tipped – diamantiert

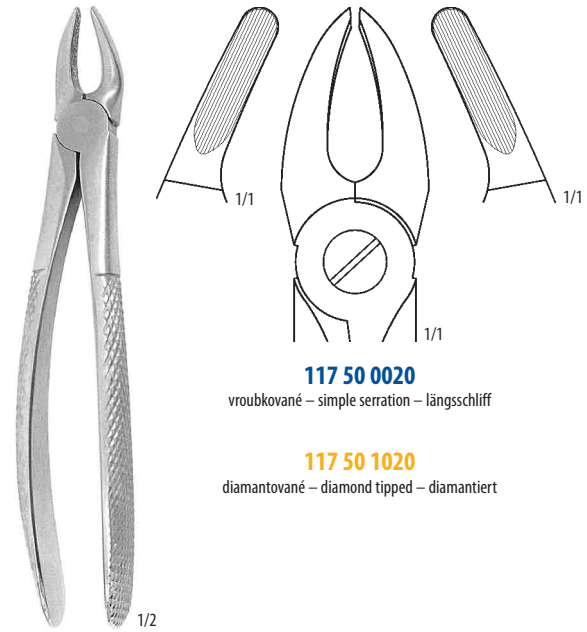

D7
 NA HORNÍ PREMOLÁRY
 FOR UPPER PREMOLARS
 FÜR OBERE PRÄMOLAREN
 16,4 cm

117 50 0020

vroubkované – simple serration – längsschliff

117 50 1020

diamantované – diamond tipped – diamantiert



D13
 NA DOLNÍ PREMOLÁRY
 FOR LOWER PREMOLARS
 FÜR UNTERE PRÄMOLAREN
 15,0 cm

117 50 0150

vroubkované – simple serration – längsschliff

117 50 1150

diamantované – diamond tipped – diamantiert



D17
 NA HORNÍ MOLÁRY PRAVÉ
 FOR RIGHT UPPER MOLARS
 FÜR OBERE MOLAREN RECHTS
 17,2 cm

117 50 0030

vroubkované – simple serration – längsschliff

117 50 1030

diamantované – diamond tipped – diamantiert



D18
NA HORNÍ MOLÁRY LEVÉ
FOR LEFT UPPER MOLARS
FÜR OBERE MOLAREN, LINKS
17,2 cm

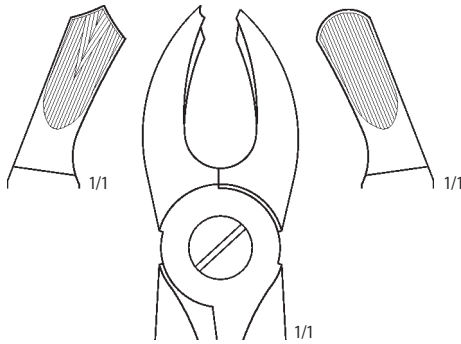

117 50 0040
vroubkované – simple serration – längsschliff
117 50 1040
diamantované – diamond tipped – diamantiert



D22
NA DOLNÍ MOLÁRY
FOR LOWER MOLARS
FÜR UNTERE MOLAREN
15,0 cm

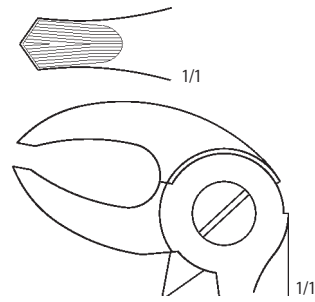

117 50 0160
vroubkované – simple serration – längsschliff
117 50 1160
diamantované – diamond tipped – diamantiert

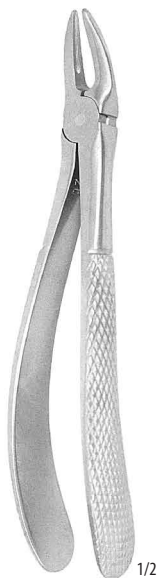

D30S
NA HORNÍ KOŘENY
FOR UPPER ROOTS
FÜR OBERE WURZELN
15,0 cm

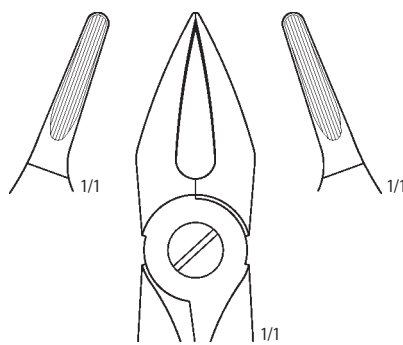

117 50 0060
vroubkované – simple serration – längsschliff
117 50 1060
diamantované – diamond tipped – diamantiert



D33
NA DOLNÍ KOŘENY ŠIROKÉ
FOR LOWER ROOTS BROAD
FÜR UNTERE WURZELN, BREIT
14,8 cm

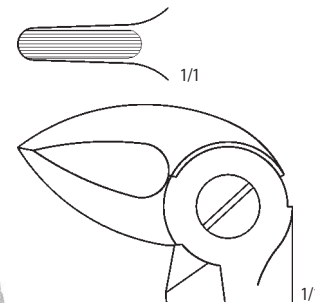

117 50 0200
vroubkované – simple serration – längsschliff
117 50 1200
diamantované – diamond tipped – diamantiert



D33A
 NA DOLNÍ KOŘENY ÚZKÉ
 FOR LOWER ROOTS
 FÜR UNTERE WURZELN
 14,8 cm

117 50 0190
 vroubkované – simple serration – längsschliff

117 50 1190
 diamantované – diamond tipped – diamantiert

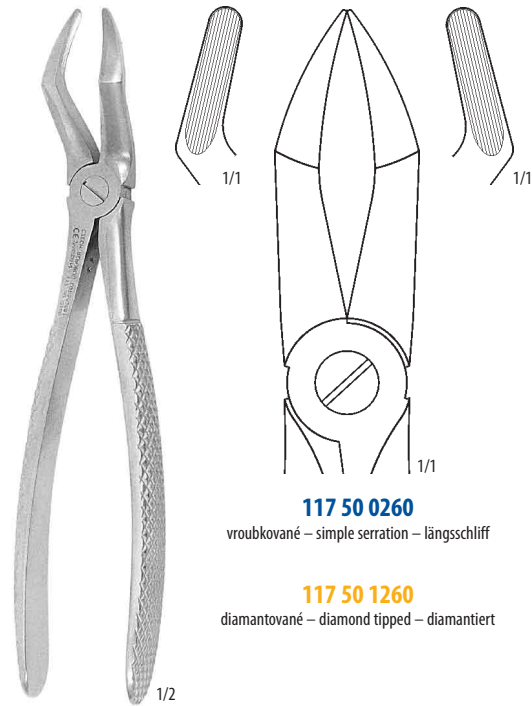

D51
 BAJONETOVÉ ŠIROKÉ
 FOR UPPER ROOTS BROAD
 FÜR OBERE WURZELN, BREIT
 18,2 cm

117 50 0260
 vroubkované – simple serration – längsschliff

117 50 1260
 diamantované – diamond tipped – diamantiert

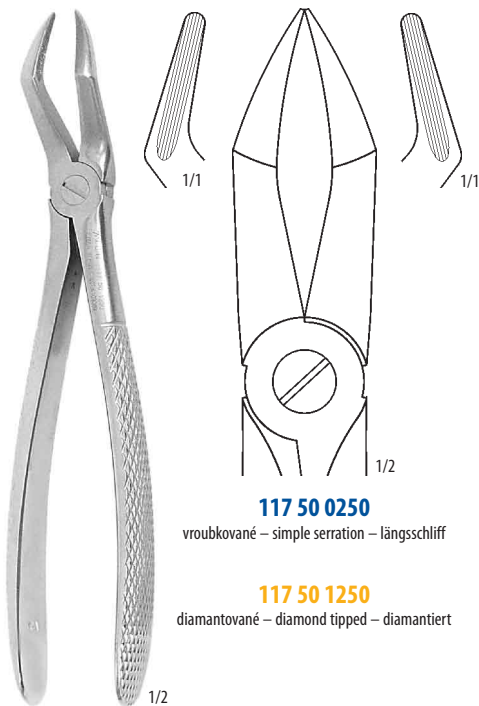

D51A
 BAJONETOVÉ ÚZKÉ
 FOR UPPER ROOTS NARROW
 FÜR UNTERE WURZELN, SCHMAL
 18,2 cm

117 50 0250
 vroubkované – simple serration – längsschliff

117 50 1250
 diamantované – diamond tipped – diamantiert

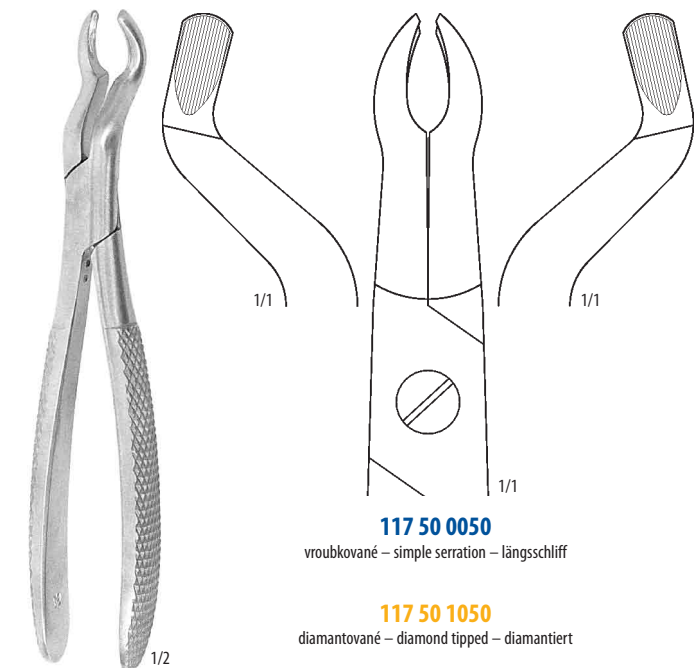

D67
 NA HORNÍ 3. MOLÁRY
 FOR UPPER WISDOMS
 FÜR OBERE WEISHEITZÄHNE
 17,4 cm

117 50 0050
 vroubkované – simple serration – längsschliff

117 50 1050
 diamantované – diamond tipped – diamantiert

**117 50 0170**

vroubkované – simple serration – längsschliff

117 50 1170

diamantované – diamond tipped – diamantiert

D73
NA DOLNÍ MOLÁRY
FOR LOWER MOLARS
FÜR UNTERE MOLAREN
15,0 cm

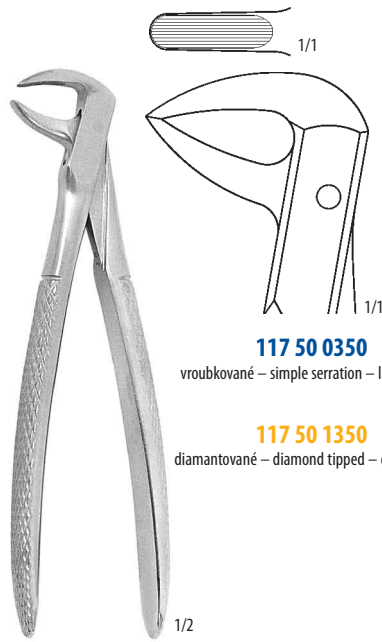
**117 50 0350**

vroubkované – simple serration – längsschliff

117 50 1350

diamantované – diamond tipped – diamantiert

D74
NA DOLNÍ KÖRENY
FOR LOWER ROOTS
FÜR OBERE WURZELN
15,0 cm

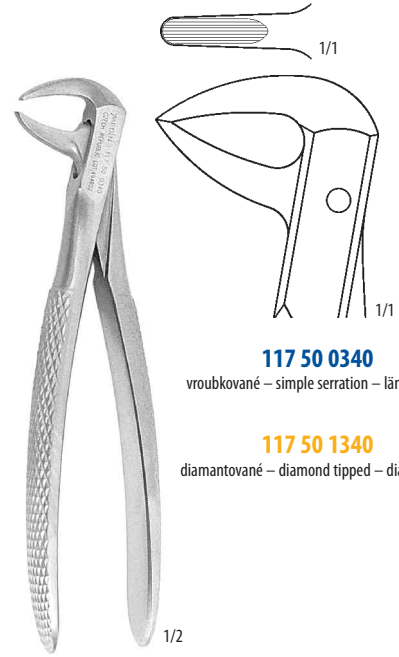
**117 50 0340**

vroubkované – simple serration – längsschliff

117 50 1340

diamantované – diamond tipped – diamantiert

D74M
NA DOLNÍ KÖRENY
FOR LOWER ROOTS
FÜR OBERE WURZELN
15,0 cm

**117 50 0330**

vroubkované – simple serration – längsschliff

117 50 1330

diamantované – diamond tipped – diamantiert

D74N
NA DOLNÍ KÖRENY
FOR LOWER ROOTS
FÜR OBERE WURZELN
15,0 cm

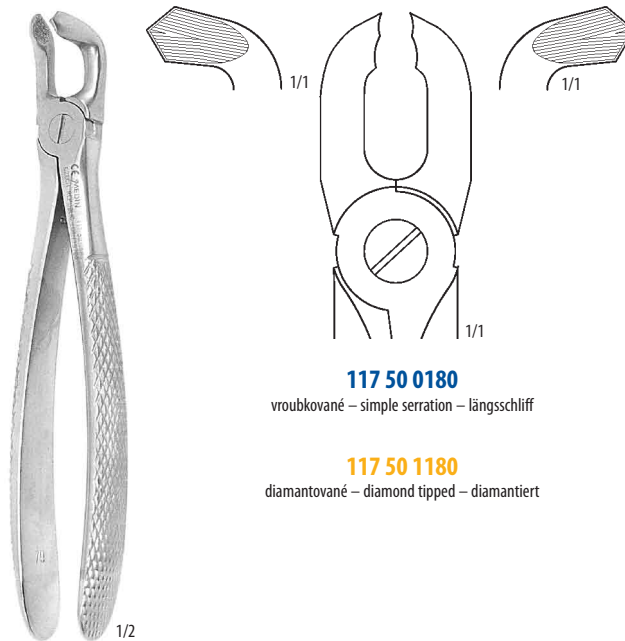
**117 50 0180**

vroubkované – simple serration – längsschliff

117 50 1180

diamantované – diamond tipped – diamantiert

D79
NA DOLNÍ 3. MOLÁRY
FOR LOWER WISDOMS
FÜR UNTERE WEISHEITZÄHNE
16,5 cm



D339
NA DOLNÍ MOLÁRY
FOR LOWER MOLARS
FÜR UNTERE MOLAREN
10,7 cm

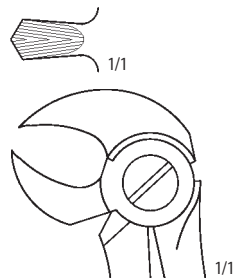

117 50 0310
vroubkované – simple serration – längsschliff
117 50 1310
diamantované – diamond tipped – diamantiert



D342
NA HORNÍ MOLÁRY
FOR UPPER MOLARS
FÜR OBERE MOLAREN
11,7 cm

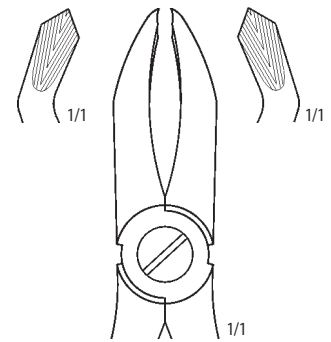

117 50 0300
vroubkované – simple serration – längsschliff
117 50 1300
diamantované – diamond tipped – diamantiert

KLEŠTĚ K ODSTRANĚNÍ KOŘENOVÝCH NÁSTROJŮ
FORCEPS FOR EXTRACTION OF ROOT INSTRUMENTS
ZANGEN ZUM ENTFERNEN VON WURZELKANALINSTRUMENTE



117 51 0600
rovné – straight – gerade
13,5 cm



117 51 1600
rovné – straight – gerade
diamantované – diamond tipped – diamantiert
13,5 cm



117 51 0610
zahnuté – curved – gebogen
13,5 cm



117 51 1610
zahnuté – curved – gebogen
diamantované – diamond tipped – diamantiert
13,5 cm

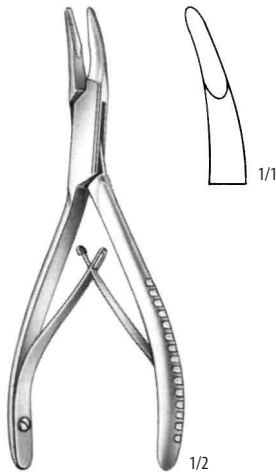

MINI-FRIEDMAN
116 91 0017
12,0 cm



FRIEDMAN
116 91 0514
14,0 cm

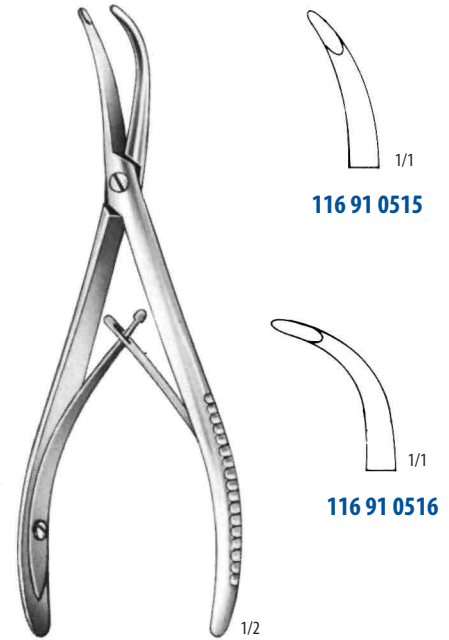

STELLBRINK
17,0 cm

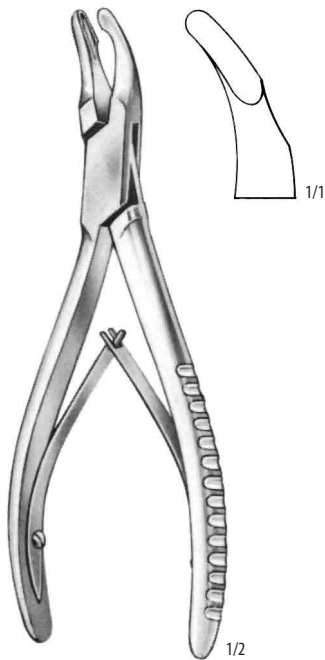

CLEVELAND
116 91 0518
17,0 cm

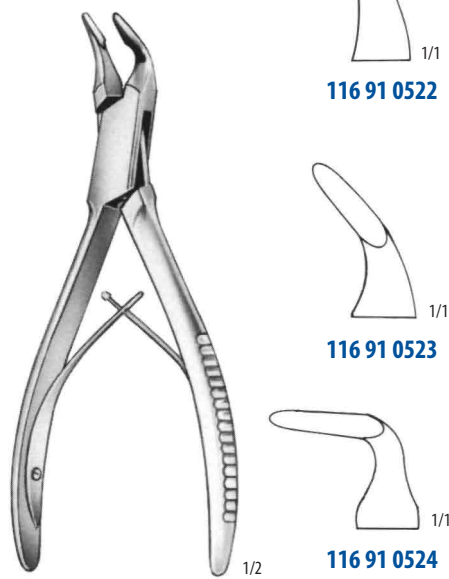

BLUMENTHAL
15,5 cm



LUER
15,0 cm

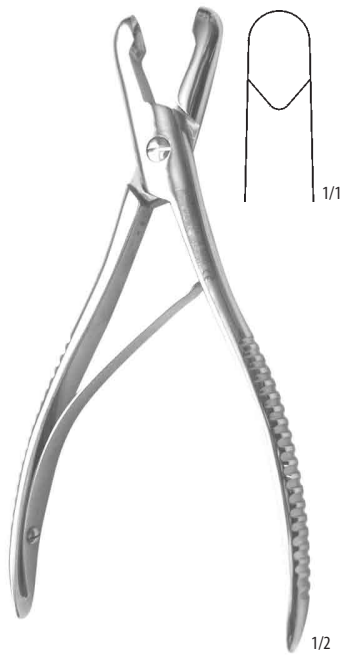

LUER
116 08 0030
rovné – straight – gerade
17,0 cm

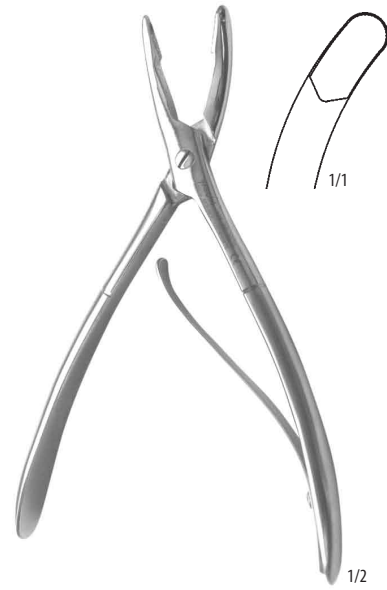

LUER
116 08 0070
zahnuté – curved – gebogen
15,0 cm

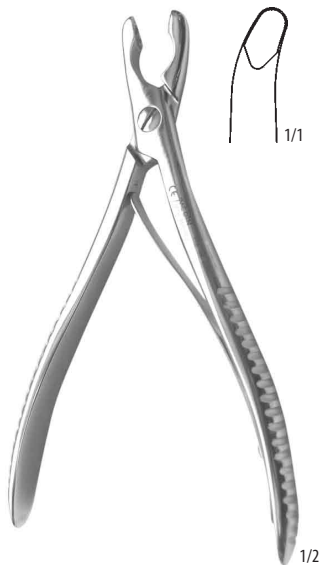

LUER
116 08 0080
zahnuté – curved – gebogen
14,5 cm

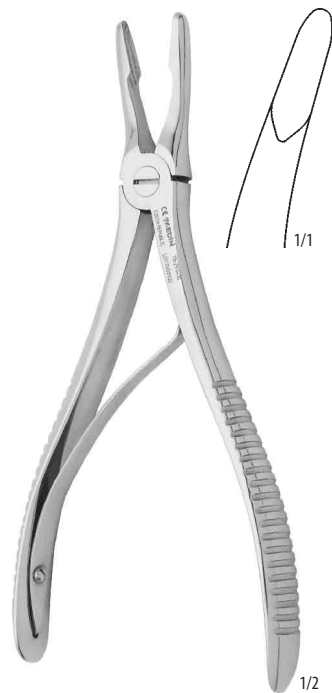

JANSEN
116 29 0410
zahnuté – curved – gebogen
18,0 cm
Fig. 2

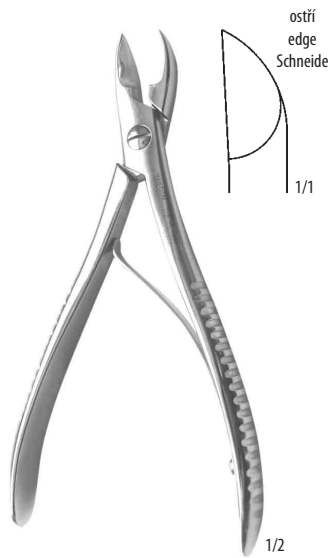

116 08 0280
rovné – straight – gerade
14,0 cm

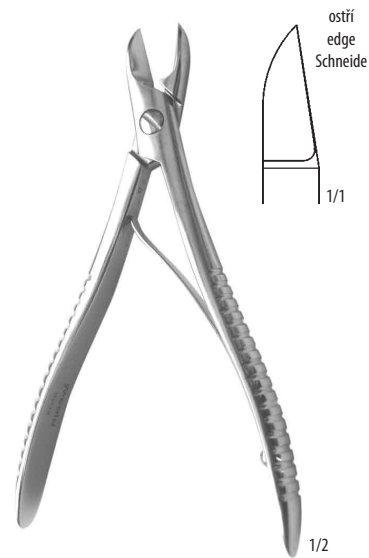

LISTON
116 08 0410
rovné – straight – gerade
14,0 cm

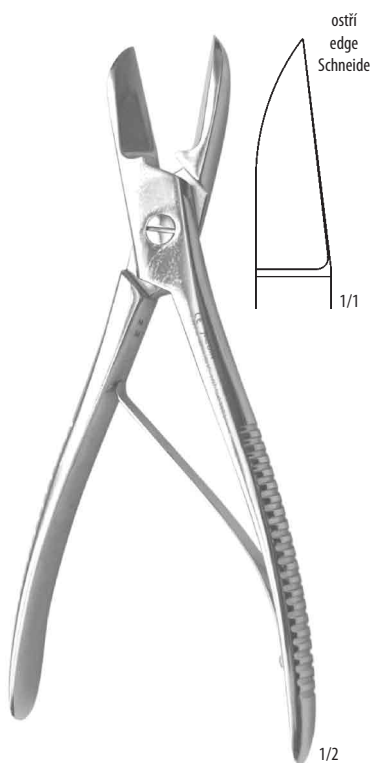

LISTON
116 08 0440
rovné – straight – gerade
19,0 cm

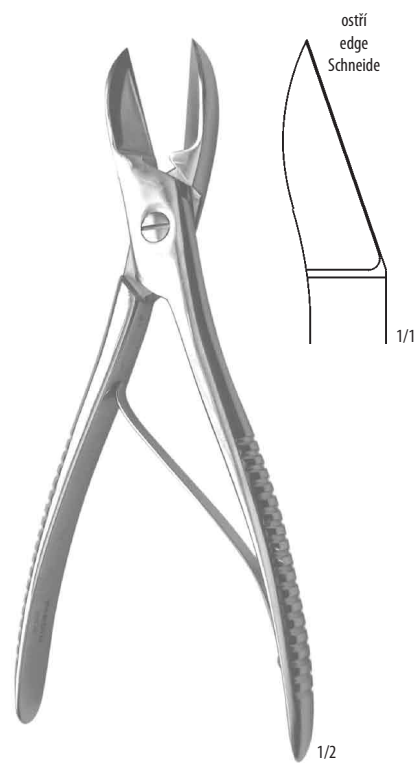

LISTON
116 08 0450
zahnuté – curved – gebogen
19,0 cm

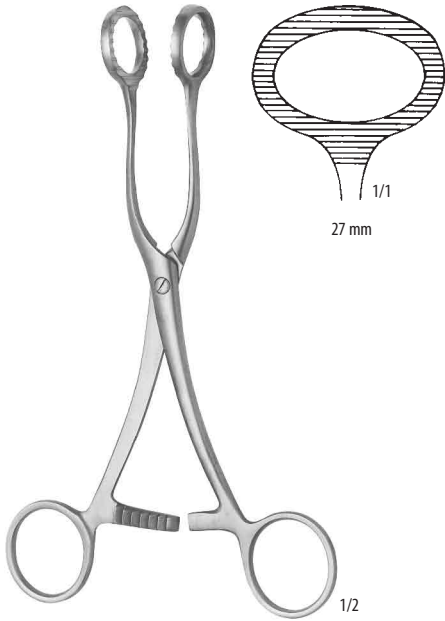

COLLIN
117 31 0010
16,7 cm

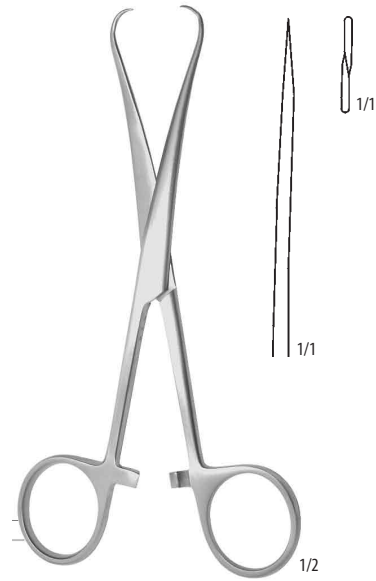

LÖBKER
117 31 0030
15,0 cm

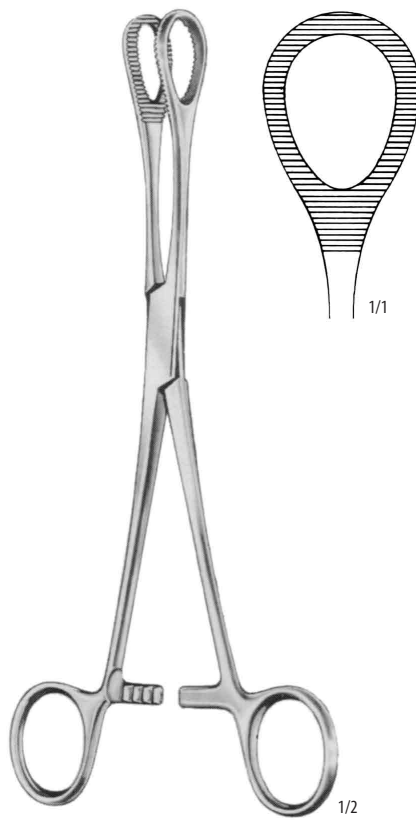

HEYWOOD-SMITH
117 91 0038
21,0 cm



HEYWOOD-SMITH
117 91 0039
25,0 cm

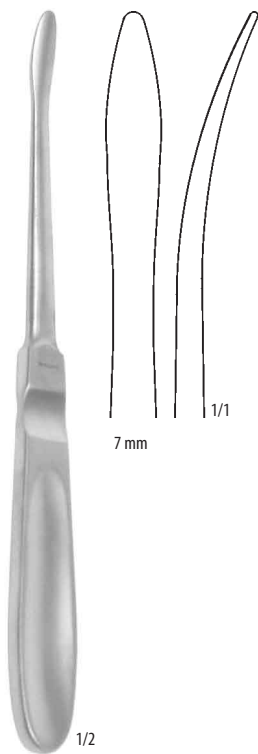

LANGENBECK
123 08 0010

19,5 cm
Fig. 1

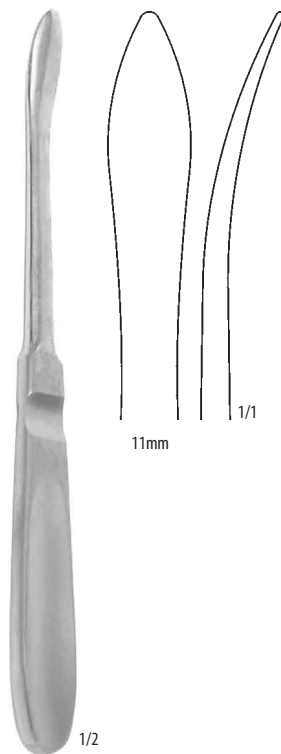

LANGENBECK
123 08 0020

19,5 cm
Fig. 2

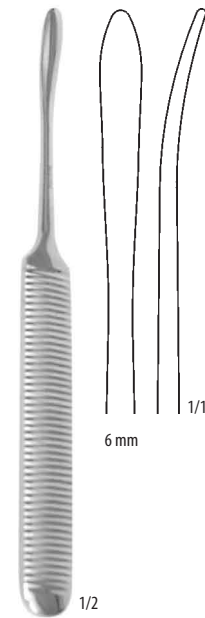

WILLIGER
123 08 0030

16,0 cm
Fig. 1

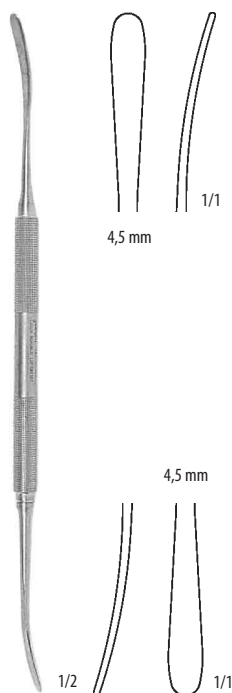
PÁČIDLA NOSNÍ
NASAL ELEVATORS
SEPTUM-ELEVATOREN

FREER
123 30 0030
17,9 cm

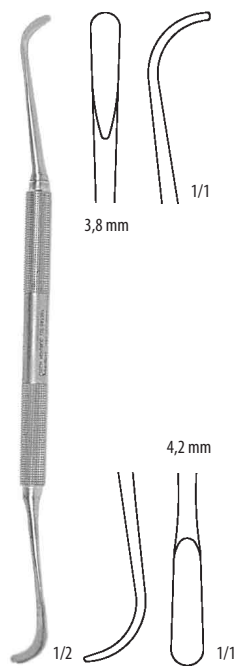

123 99 0084
17,0 cm



FREER
19,0 cm

123 91 0006
ostré – sharp – scharf

123 91 0007
tupé – blunt – stumpf

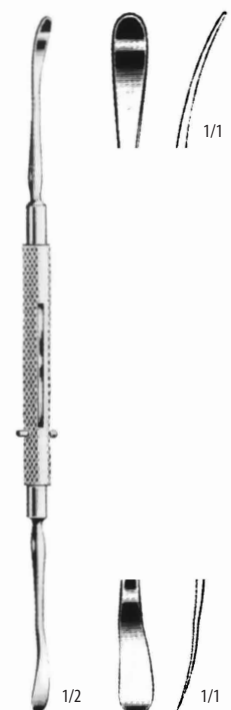

FREER
123 91 0008
18,0 cm

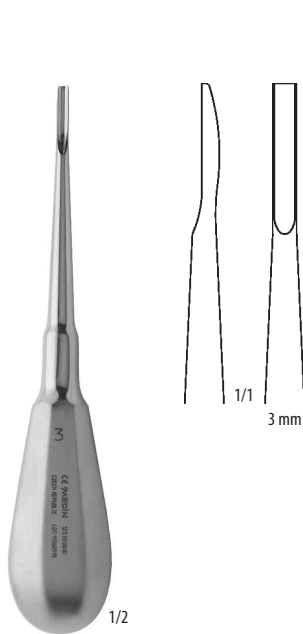

BEIN
123 50 0010
rovná – straight – gerade
14,5 cm



BEIN
123 50 0011
rovná – straight – gerade
16,5 cm

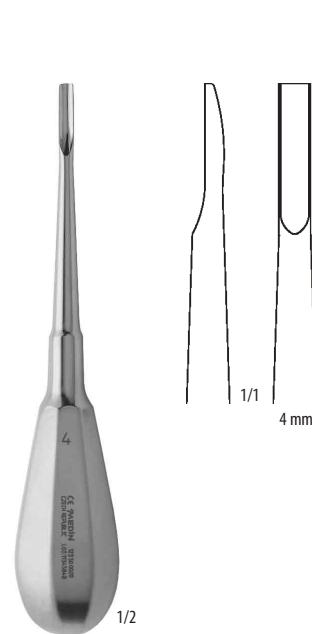

BEIN
123 50 0020
rovná – straight – gerade
14,5 cm



BEIN
123 50 0021
rovná – straight – gerade
16,5 cm

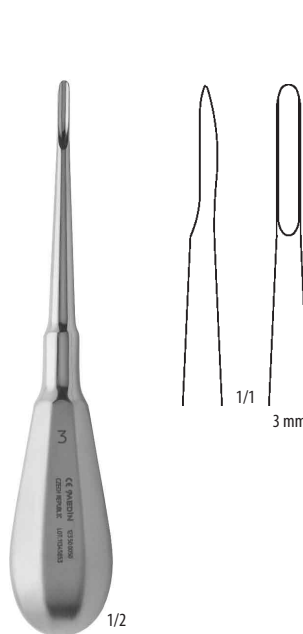

BEIN
123 50 0050
oblouková – embowed – gebogen
14,5 cm



BEIN
123 50 0051
oblouková – embowed – gebogen
16,5 cm

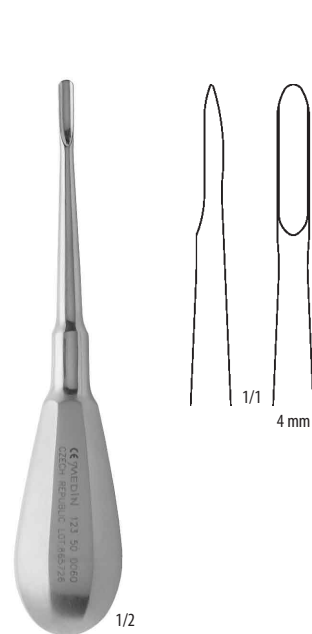

BEIN
123 50 0060
oblouková – embowed – gebogen
14,5 cm

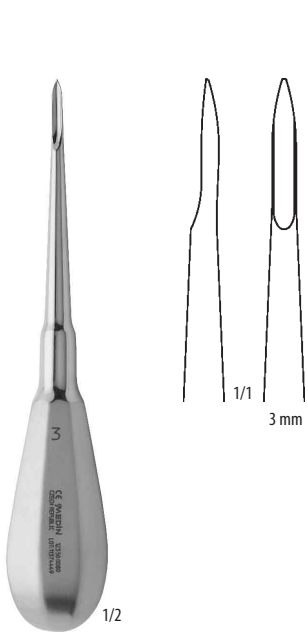
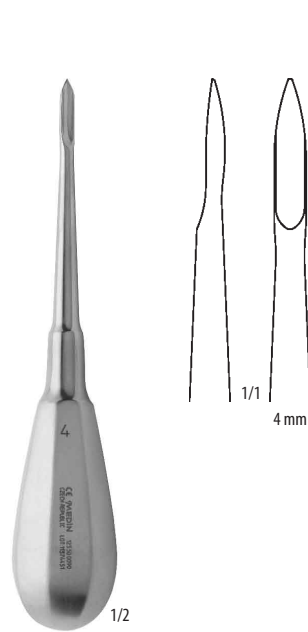
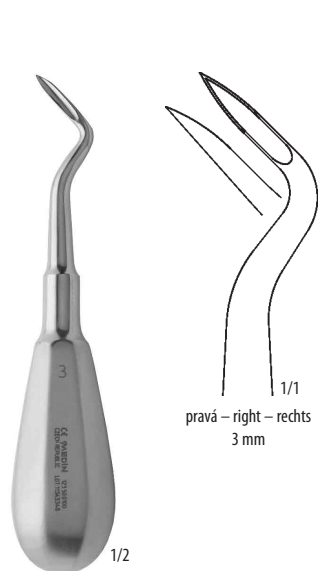
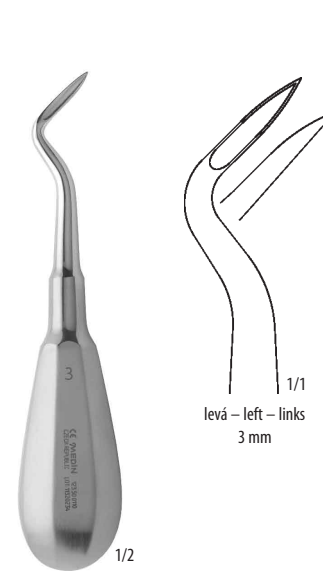

BEIN
123 50 0061
oblouková – embowed – gebogen
16,5 cm

**BEIN****123 50 0080**rovná, jemná – straight, fine – gerade, fein
14,5 cm**BEIN****123 50 0081**rovná, jemná – straight, fine – gerade, fein
16,5 cm**BEIN****123 50 0090**rovná, jemná – straight, fine – gerade, fein
14,5 cm**BEIN****123 50 0091**rovná, jemná – straight, fine – gerade, fein
16,5 cm**FLOHR****123 50 0100**hrotnatá, ostrá – pointed, sharp – scharf
13,0 cm**FLOHR****123 50 0101**hrotnatá, ostrá – pointed, sharp – scharf
15,0 cm**FLOHR****123 50 0110**hrotnatá, ostrá – pointed, sharp – scharf
13,0 cm**FLOHR****123 50 0111**hrotnatá, ostrá – pointed, sharp – scharf
15,0 cm



1/2

SCHLEMMER
123 50 0130
pravá – right – rechts
15,1 cm

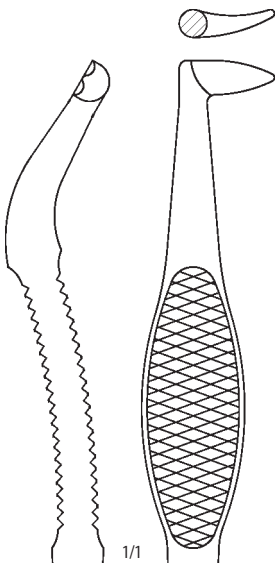

1/1



1/2

SCHLEMMER
123 50 0131
pravá – right – rechts
17,1 cm



1/2

SCHLEMMER
123 50 0140
levá – left – links
15,1 cm

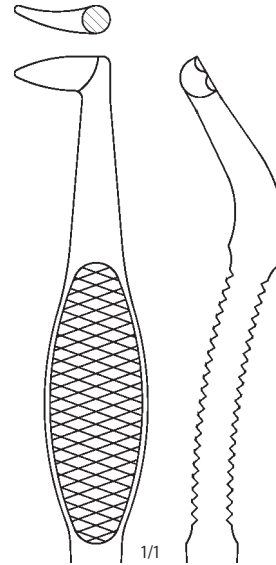

1/1



1/2

SCHLEMMER
123 50 0141
levá – left – links
17,1 cm



1/2

123 50 0160
rovná, pravá – straight, right – gerade, links
14,5 cm

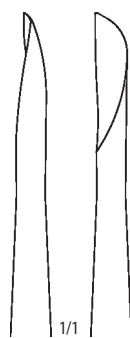

1/1

4 mm



1/2

123 50 0170
rovná, levá – straight, left – gerade, links
14,5 cm



1/1

4 mm



1/2



4 mm

ŠPINAR
123 50 0210
přední – frontal – Front
14,8 cm



1/2

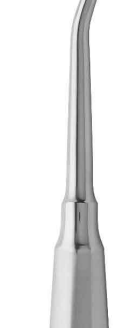

ŠPINAR
123 50 0211
přední – frontal – Front
16,8 cm



1/2



ŠPINAR
123 50 0220
zadní – retral – Seite
14,8 cm



1/2



ŠPINAR
123 50 0221
zadní – retral – Seite
16,8 cm



1/2



3 mm

WHITE
123 50 0280
oblouková, vyhnutá – embowed, angled – gebogen
14,5 cm



1/2



4 mm

WHITE
123 50 0290
oblouková, vyhnutá – embowed, angled – gebogen
14,5 cm

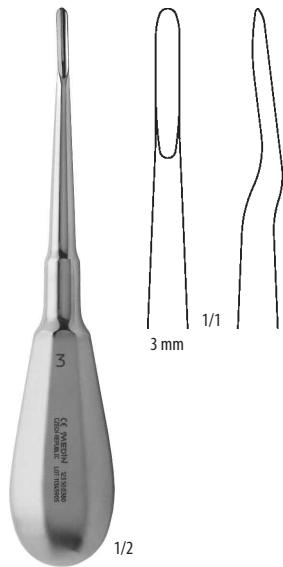

WHITE
123 50 0380
oblouková, vyhnutá – embowed, angled – gebogen
14,5 cm

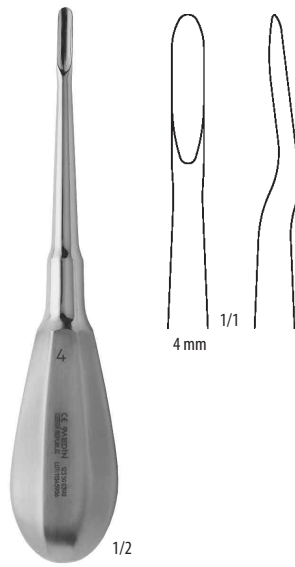

WHITE
123 50 0390
oblouková, vyhnutá – embowed, angled – gebogen
14,5 cm

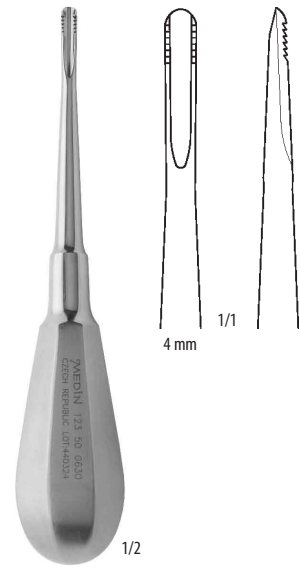

123 50 0630
se zuby, rovná – with saw, straight – gezahnt, gerade
14,5 cm

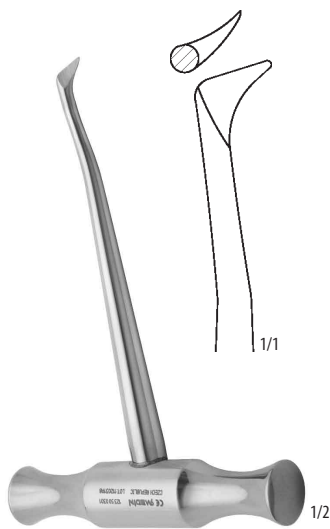

BARRY
123 50 0301
pravá – right – rechts
12,4 cm

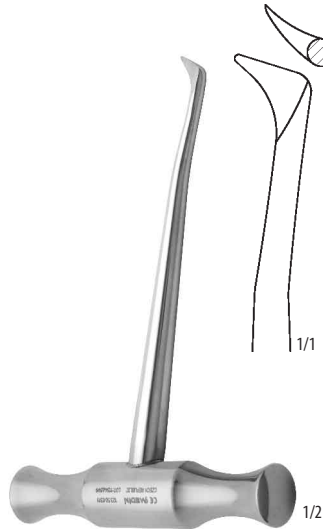

BARRY
123 50 0311
levá – left – links
12,4 cm

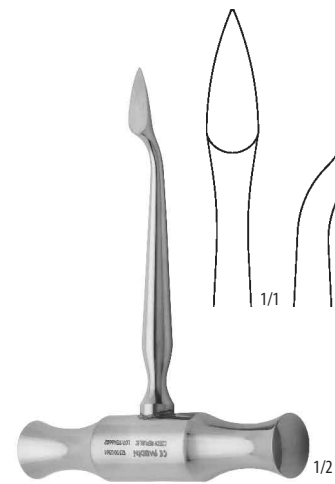

LECLUSE
123 50 0361
10,8 cm

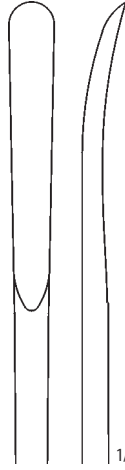
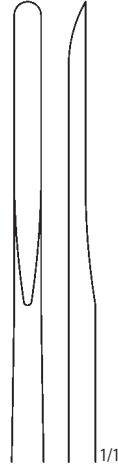
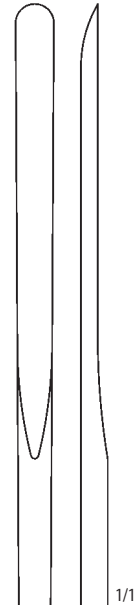
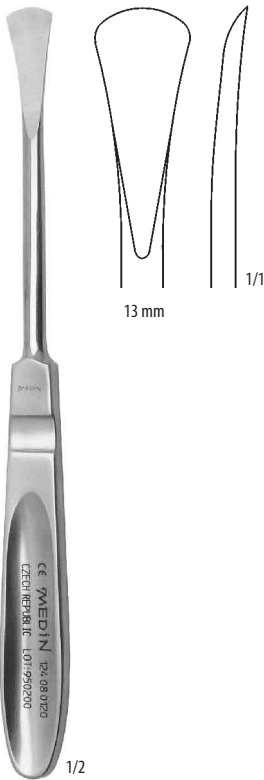
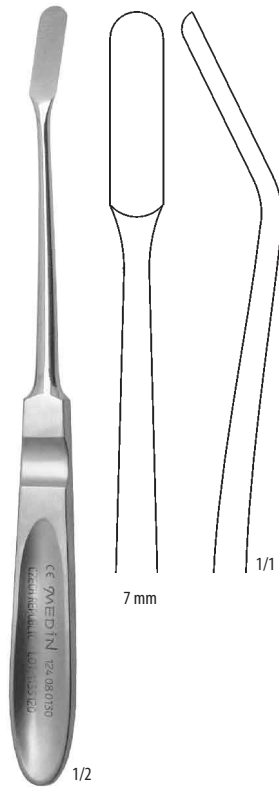
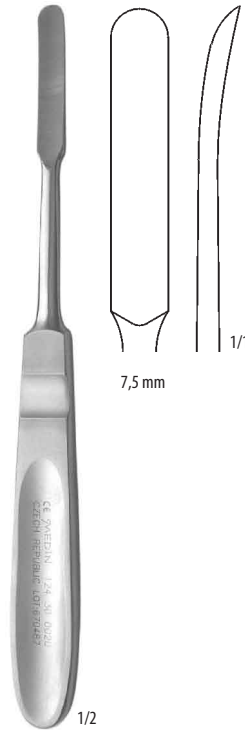
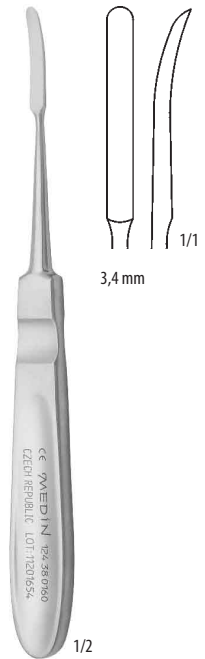
Original 16 cm
6 mm**WILLIGER**
16,0 cm**124 08 0111**
16,0 cm
6 mm**124 08 0280**
16,0 cm
3,5 mm**124 08 0290**
16,0 cm
3,5 mm**124 08 0250**
18,0 cm
5 mm**LANGENBECK**
124 08 0120
20,5 cm**LANGENBECK**
124 08 0130
20,4 cm**PŘEČHTĚL**
124 30 0020
19,0 cm**124 38 0160**
17,2 cm

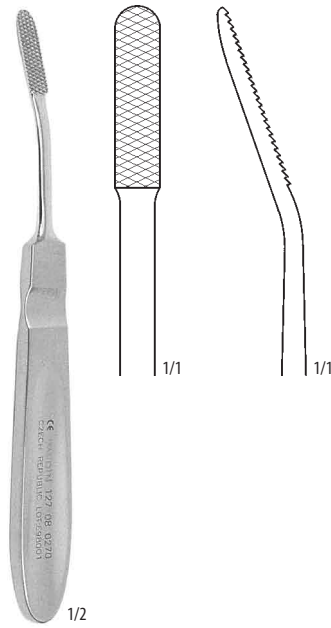

127 08 0270
15,9 cm

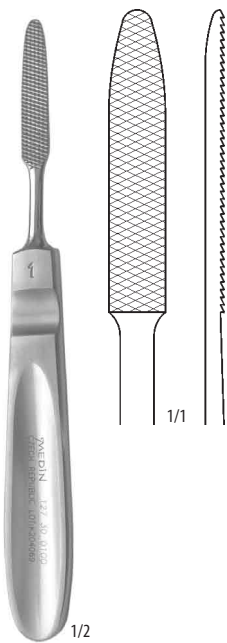

JOSEPH
127 30 0100
16,5 cm
Fig. 1

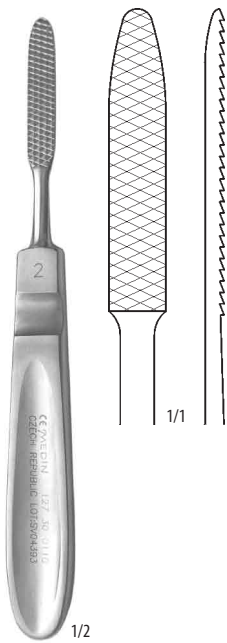

JOSEPH
127 30 0110
16,5 cm
Fig. 2

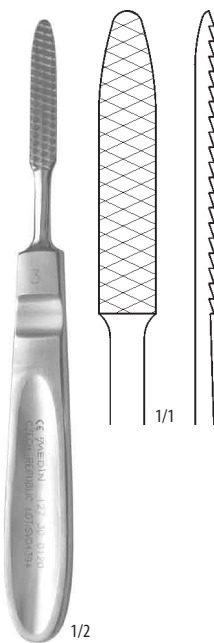

JOSEPH
127 30 0120
16,5 cm
Fig. 3

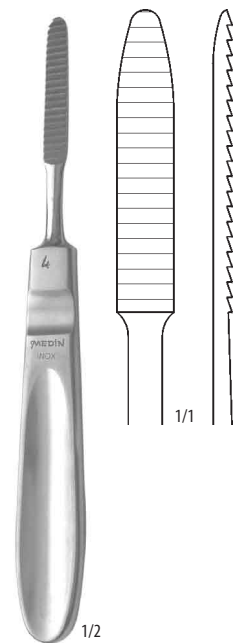

JOSEPH
127 30 0130
16,5 cm
Fig. 4

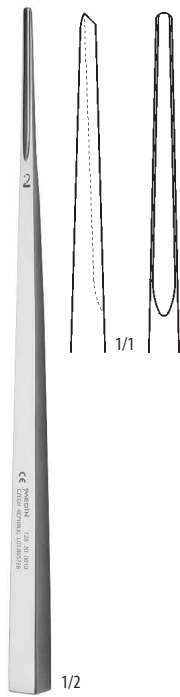

128 30 0010
18,0 cm
2 mm

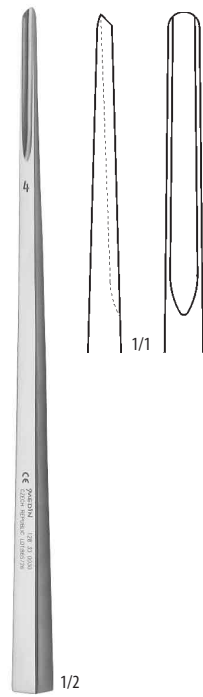

128 30 0030
18,0 cm
4 mm

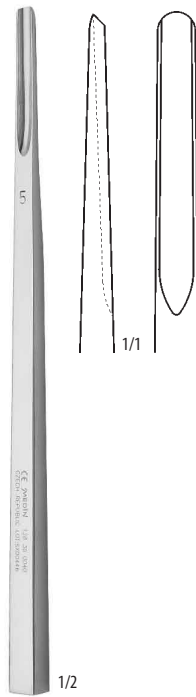

128 30 0040
18,0 cm
5 mm

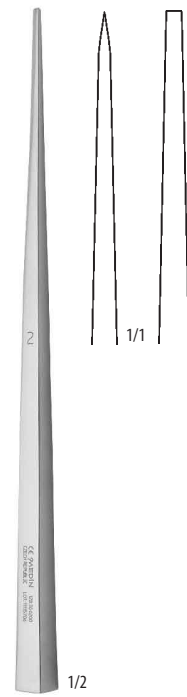

WEST
128 30 0200
18,0 cm
2 mm

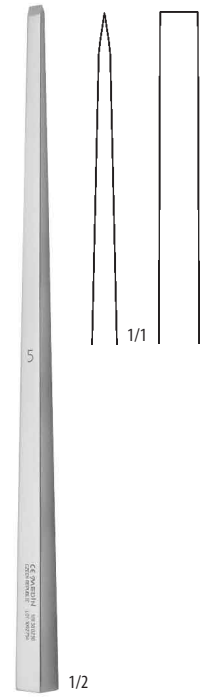

WEST
128 30 0230
18,0 cm
5 mm

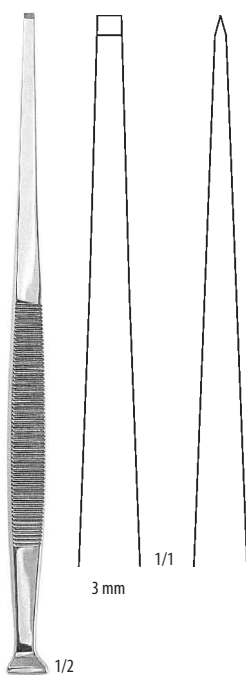
DLÁTA JEMNÁ
CHISELS FINE
MEISSEL FEIN

128 50 0050
ploché – flat – flach
17,5 cm

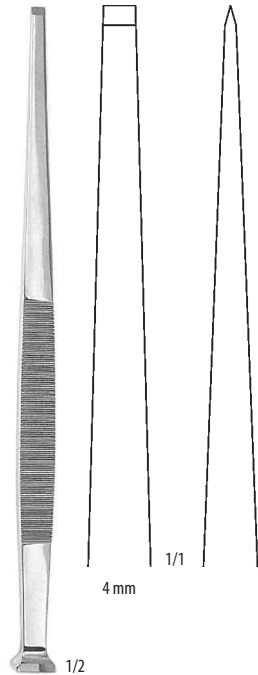

128 50 0060
ploché – flat – flach
17,5 cm

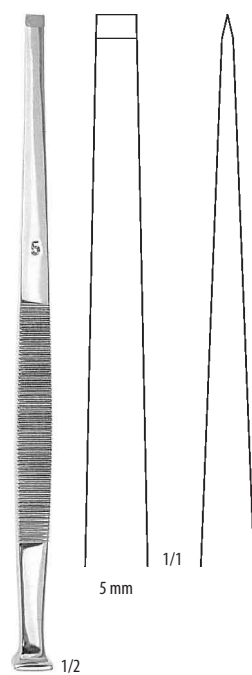

128 50 0070
ploché – flat – flach
17,5 cm

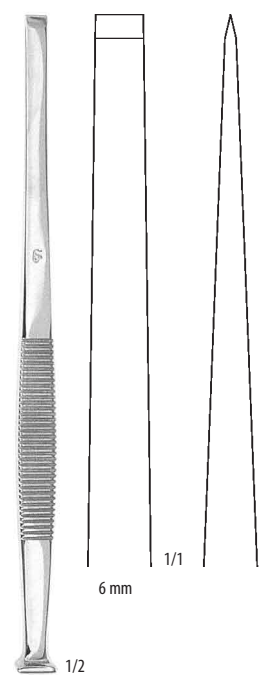

128 50 0080
ploché – flat – flach
17,5 cm

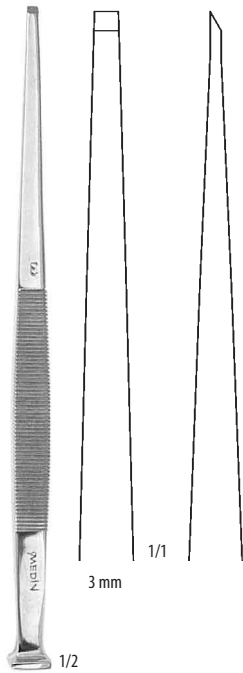

128 50 0110
poloklínové – half-wedged – keilförmig
17,5 cm

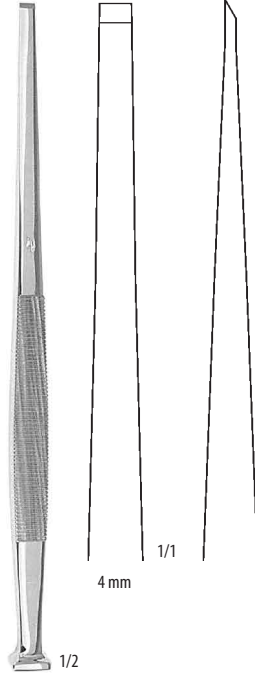

128 50 0120
poloklínové – half-wedged – keilförmig
17,5 cm

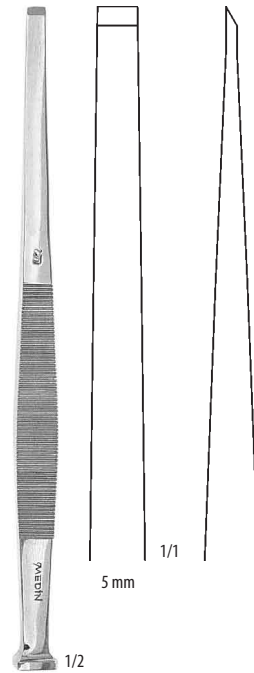

128 50 0130
poloklínové – half-wedged – keilförmig
17,5 cm

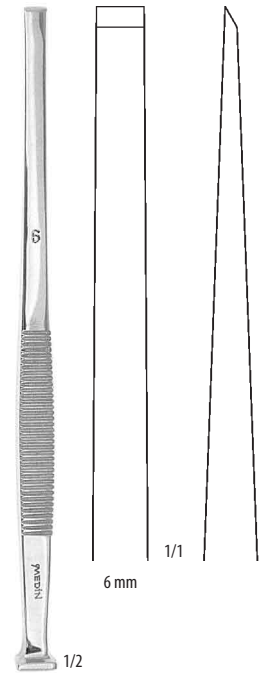

128 50 0140
poloklínové – half-wedged – keilförmig
17,5 cm

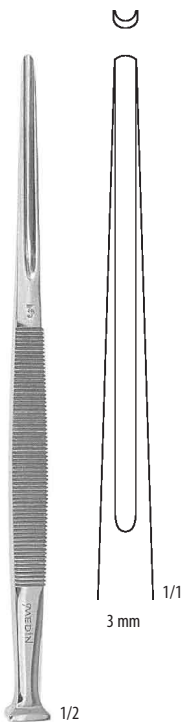

128 50 0200
žlábkové – grooved – hohl
17,5 cm

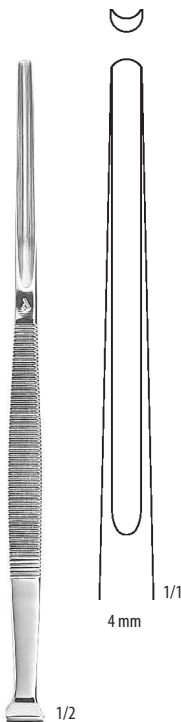

128 50 0210
žlábkové – grooved – hohl
17,5 cm

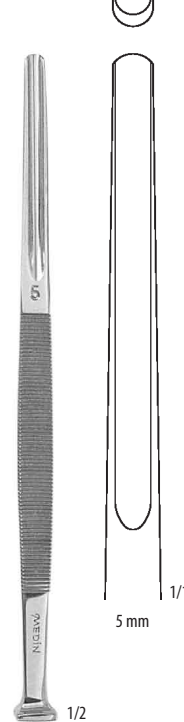

128 50 0220
žlábkové – grooved – hohl
17,5 cm

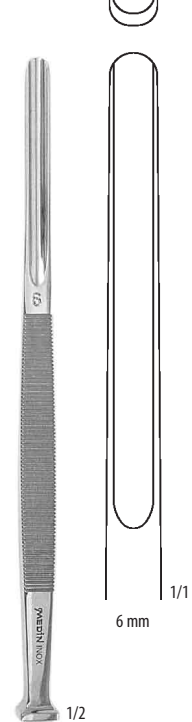

128 50 0230
žlábkové – grooved – hohl
17,5 cm



KLADÍVKO CHIRURGICKÉ
SURGICAL Mallet
METALLHAMMER
128 08 0901
250 g
22,3 cm

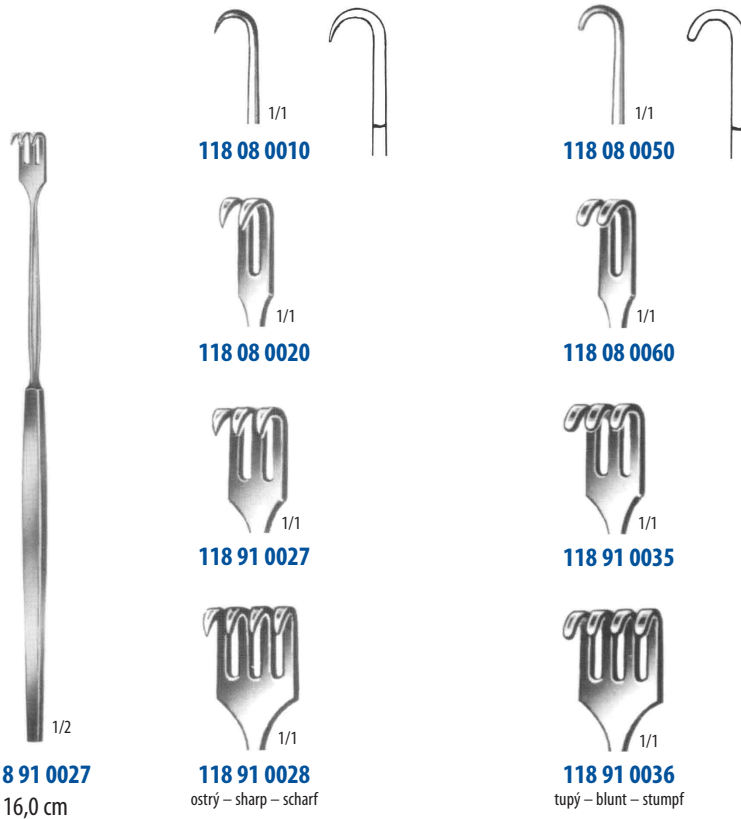

KLADÍVKO CHIRURGICKÉ
SURGICAL Mallet
METALLHAMMER
128 08 0911
500 g
23,5 cm

118 91 0027
16,0 cm

118 91 0028
ostrý – sharp – scharf

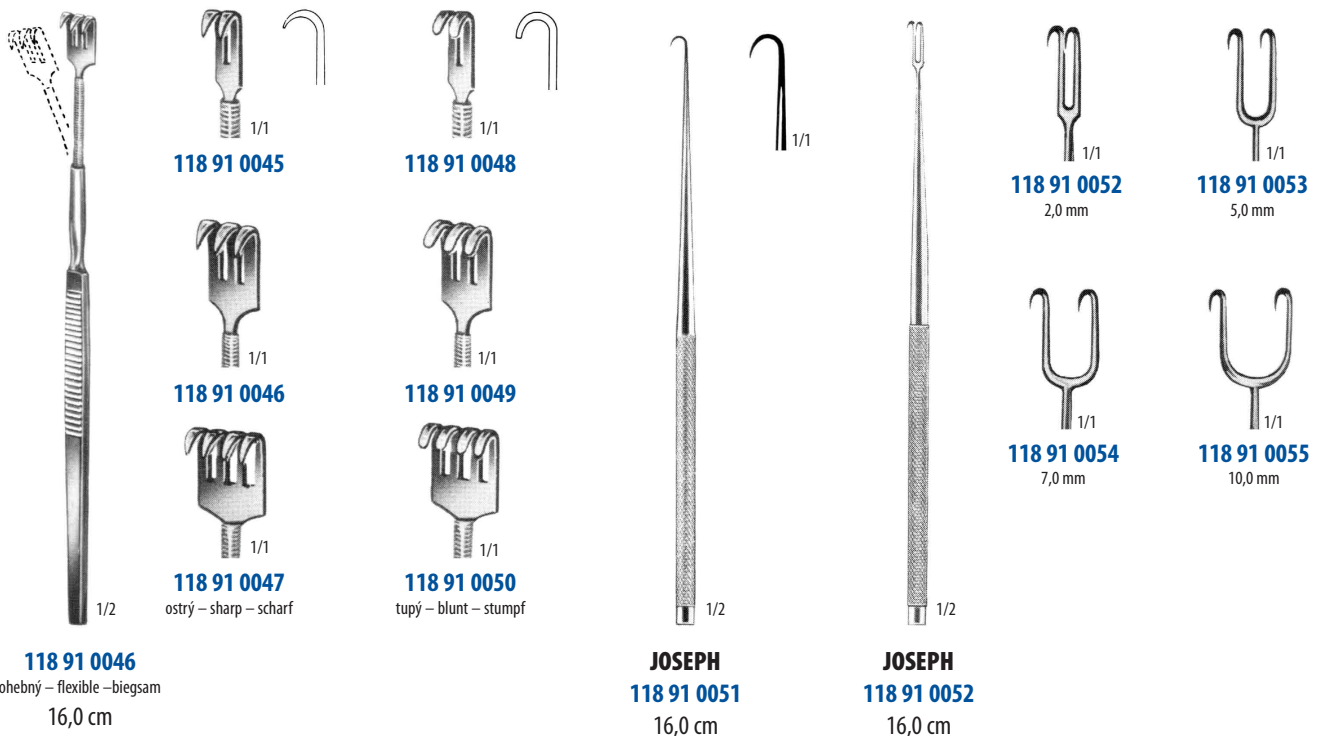
118 91 0036
tupý – blunt – stumpf

118 91 0046
ohébný – flexible – biegsam
16,0 cm

JOSEPH
118 91 0051
16,0 cm

JOSEPH
118 91 0052
16,0 cm

118 91 0052
2,0 mm

118 91 0053
5,0 mm

118 91 0054
7,0 mm

118 91 0055
10,0 mm



DESMARRES
13,0 cm

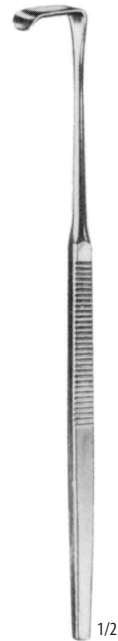
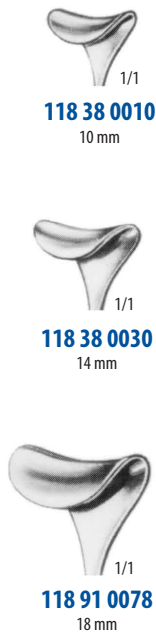

MINI-LANGENBECK
16,0 cm



CUSHING
20,0 cm



CUSHING
24,0 cm



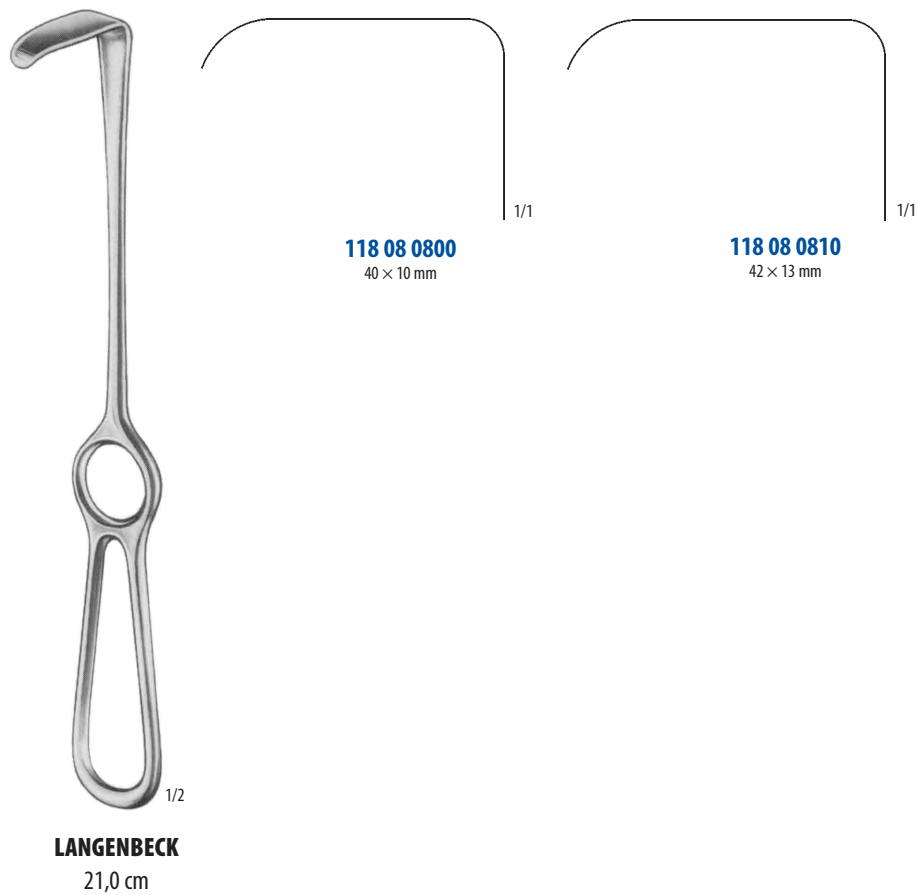
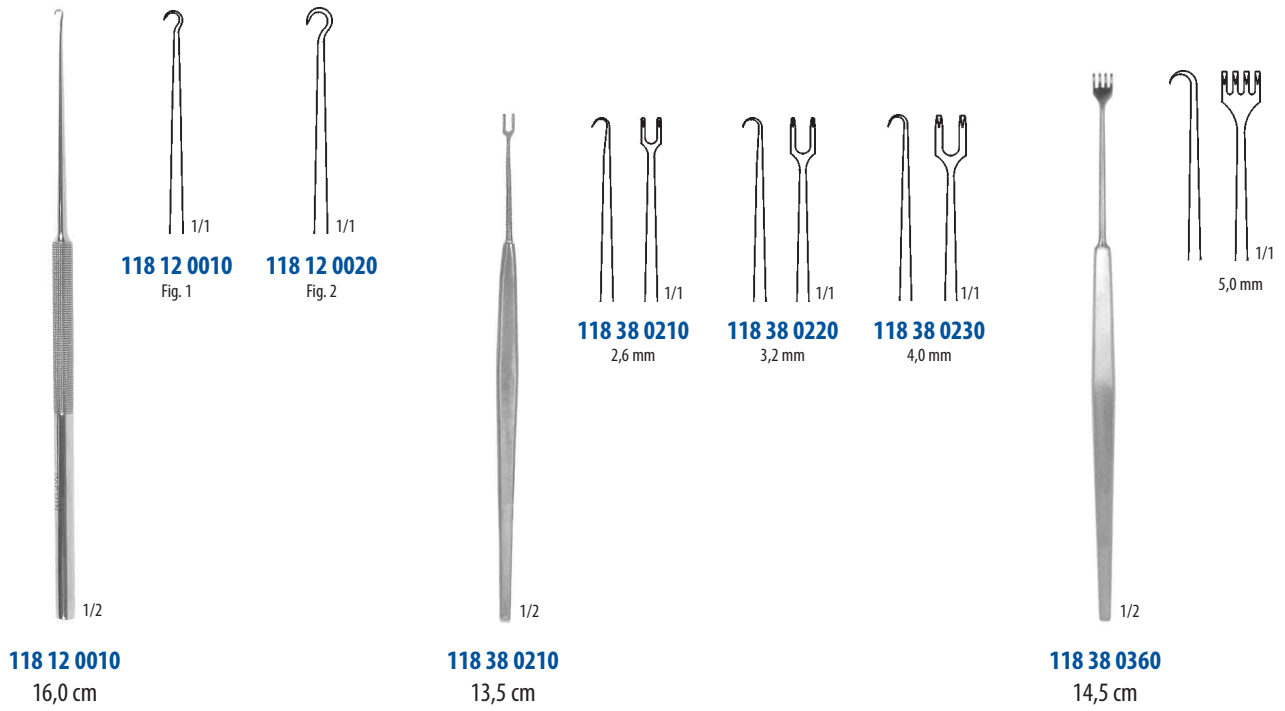



MIDDELDORPF
118 08 0650



118 08 0650
14 × 12 mm
22,0 cm



118 08 0660
21 × 21 mm
22,0 cm



118 08 0670
32 × 31 mm
23,5 cm

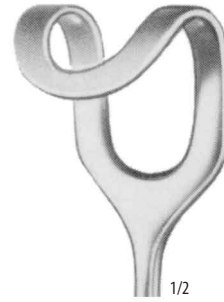

118 08 0680
62 × 50 mm
28,0 cm



MIDDELDORPF
118 91 0208



118 91 0208
14 × 17 mm
21,5 cm



118 91 0209
20 × 22 mm
22,0 cm



118 91 0210
26 × 30 mm
23,5 cm

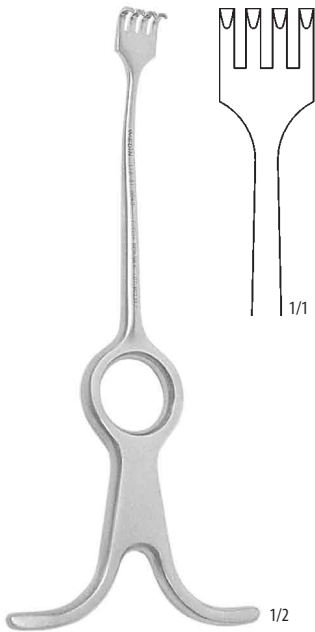

118 31 0040
rovný – straight – gerade
16,4 cm

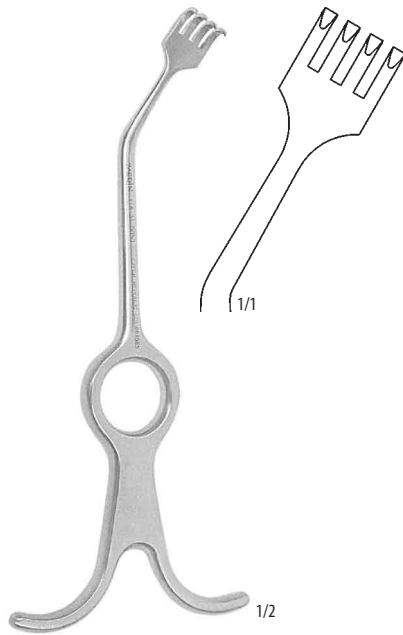

118 31 0050
pravý – right – rechts
16,2 cm

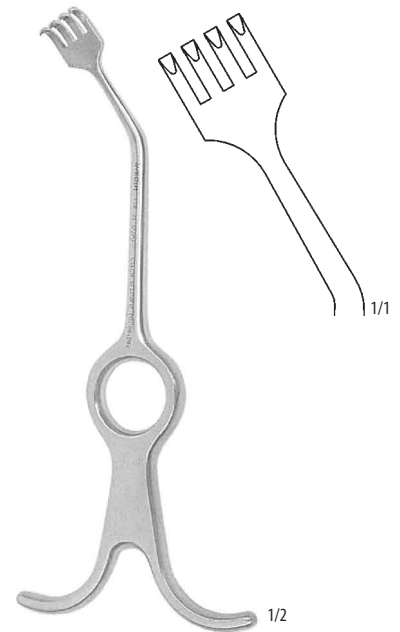

118 31 0060
levý – left – links
16,2 cm

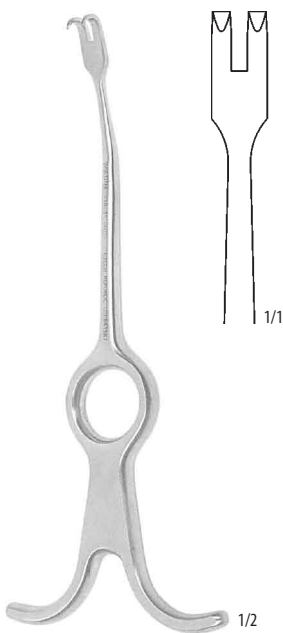

118 31 0070
rovný – straight – gerade
16,4 cm

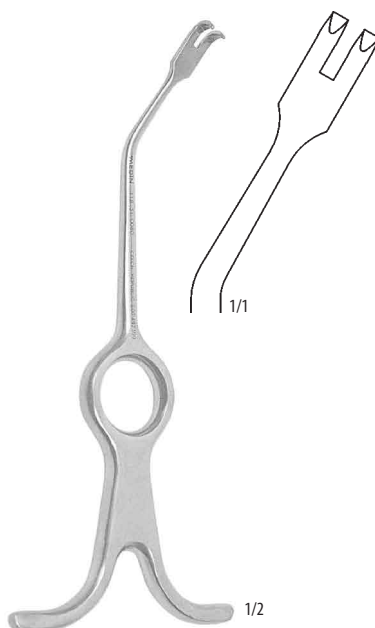

118 31 0080
pravý – right – rechts
16,1 cm

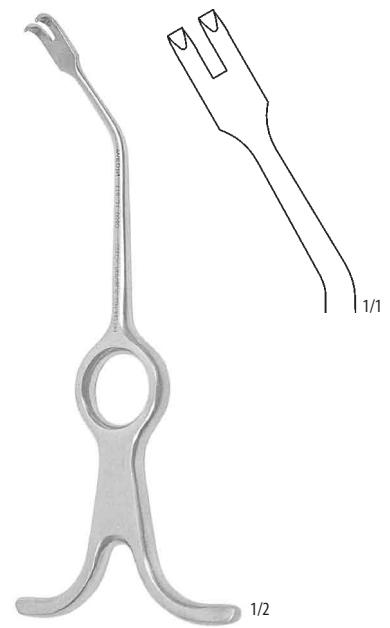

118 31 0090
levý – left – links
16,1 cm

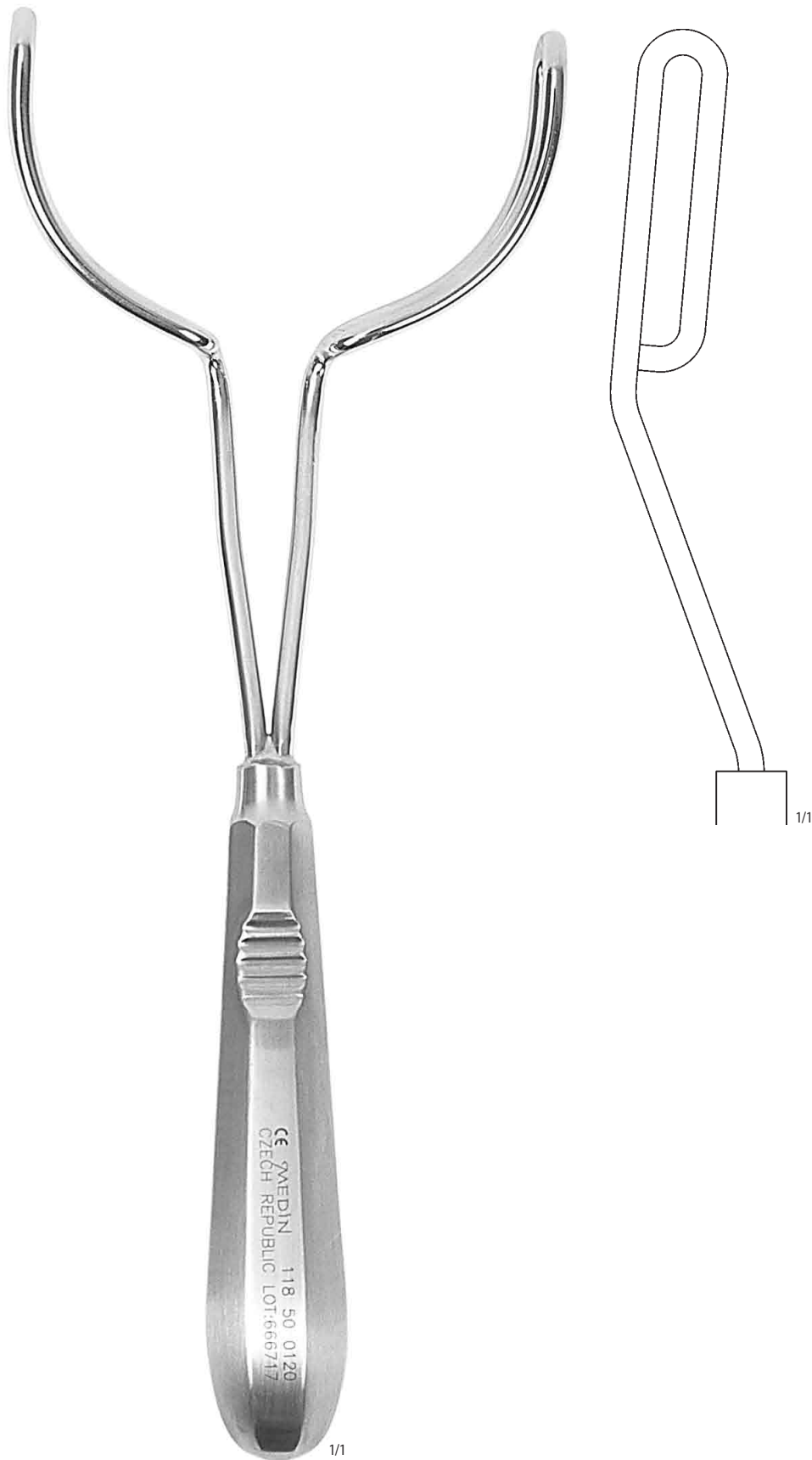

118 50 0120
22,9 cm

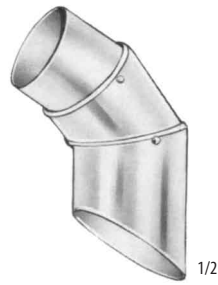

LANGENBECK

	Ø
136 91 0001	2,20 cm
136 91 0002	2,45 cm
136 91 0003	2,65 cm

ROZVĚRAČE ÚST
MOUTH RETRACTORS
MUNDSPERRER



ROSER-KÖNIG
119 07 0010
19,5 cm

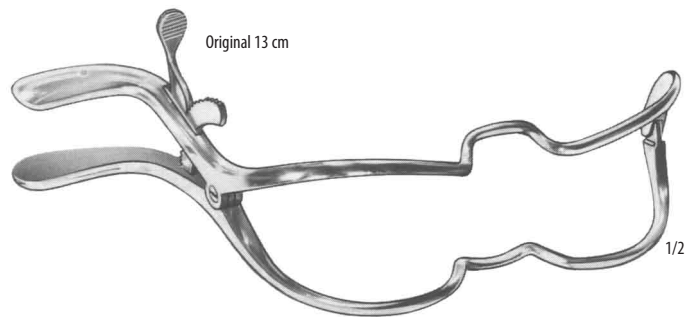
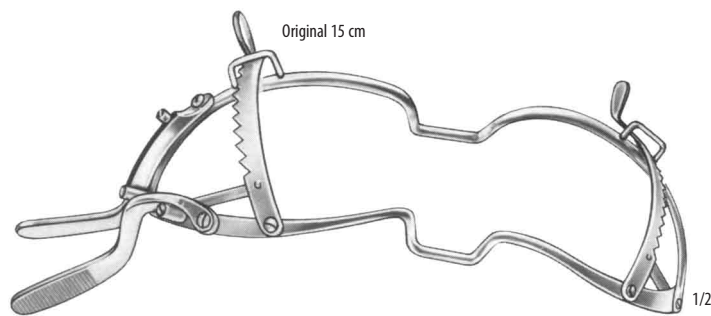
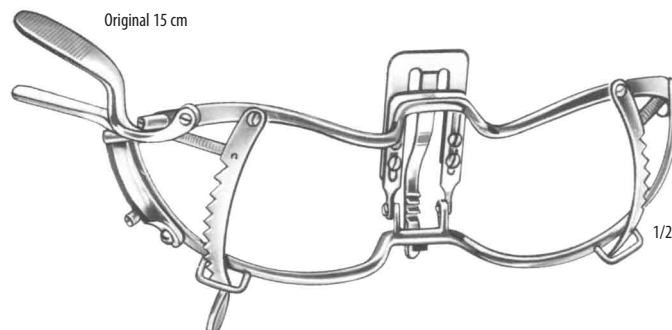

HEISTER
119 07 0020
13,0 cm

**JENNINGS****119 91 0185** – 9,0 cm**119 91 0186** – 11,0 cm**119 91 0187** – 13,0 cm**119 91 0188** – 15,0 cm**WHITEHEAD****119 91 0189** – 9,0 cm**119 91 0190** – 11,0 cm**119 91 0191** – 13,0 cm**119 91 0192** – 15,0 cm**WHITEHEAD****119 91 0193** – 9,0 cm**119 91 0194** – 11,0 cm**119 91 0195** – 13,0 cm**119 91 0196** – 15,0 cm

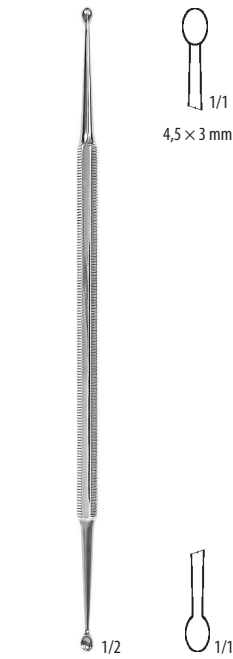

125 50 0010
rovná – straight – gerade
17,0 cm

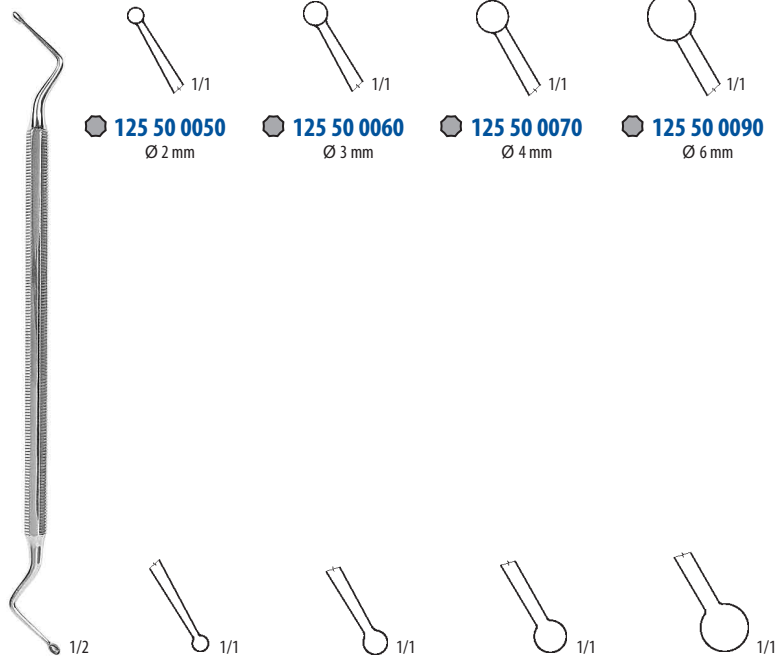

125 50 0050
lomená, ostrá – angled, sharp – gebogen, scharf
17,0 cm



125 56 0066
lomená, ostrá – angled, sharp – gebogen, scharf
16,7 cm

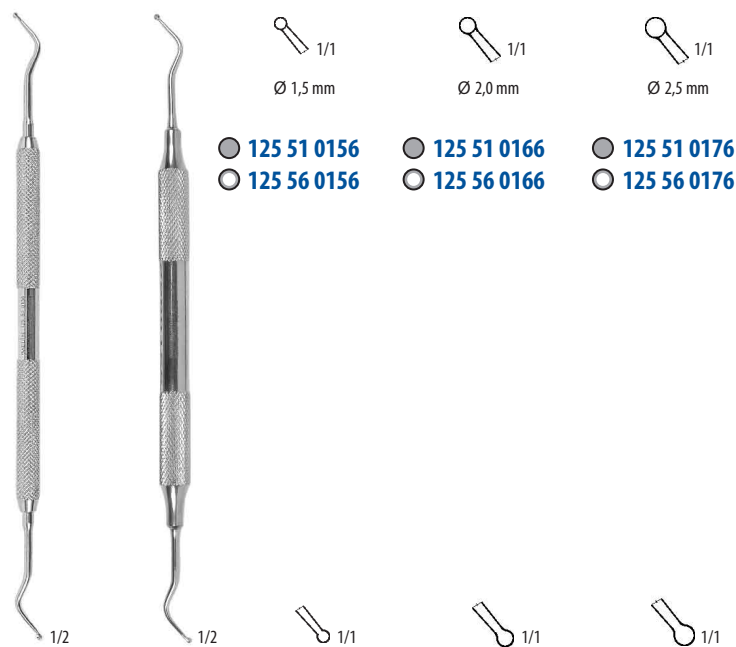

125 51 0156 **125 56 0156**
ostrá – sharp – scharf ostrá – sharp – scharf
16,6 cm 16,6 cm

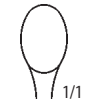
**125 08 0110**17,0 cm
Fig. 000
3,5 mm**125 08 0120**17,2 cm
Fig. 0
4,8 mm**125 08 0130**17,5 cm
Fig. 1
6,0 mm**125 08 0140**17,7 cm
Fig. 3
8,5 mm**125 08 0150**18,4 cm
Fig. 5
12,0 mm**125 08 0160**16,5 cm
Fig. 1
3,0 mm**125 08 0170**16,5 cm
Fig. 2
3,5 mm**125 08 0180**17,5 cm
Fig. 3
4,0 mm**125 08 0190**17,5 cm
Fig. 4
5,0 mm**125 08 0200**19,5 cm
Fig. 5
6,0 mm**125 08 0210**19,5 cm
Fig. 6
6,7 mm



125 50 0100
pravá – right – rechts
16,3 cm



125 50 0110
levá – left – links
16,3 cm

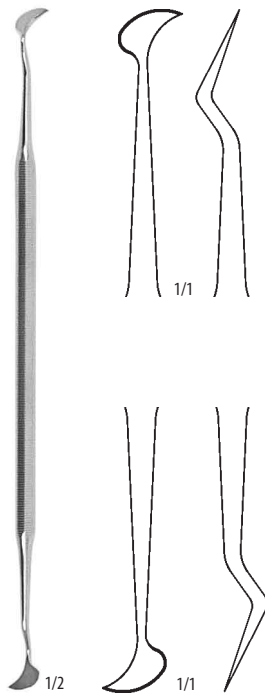

NŮŽ NA DÁSEŇ OBOUSTRANNÝ
GUM KNIFE MUTUAL
ZAHNFLAISCHMESSER
112 50 0050
18,0 cm

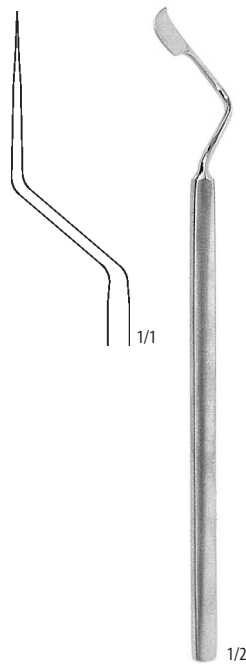

NŮŽ NA GINGIVECTOMII
GINGIVECTOMY KNIFE
GINGIVECTOMIE-MESSER
112 50 0060
17,3 cm
Fig. 1

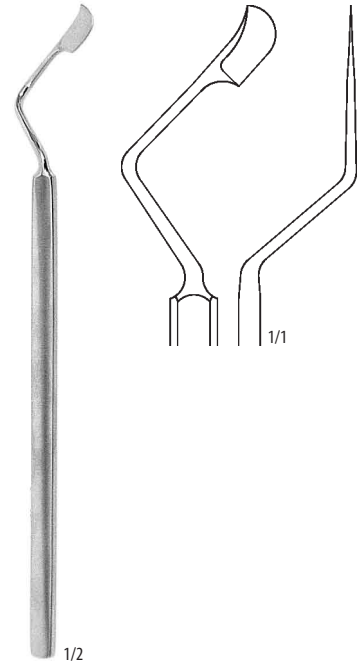

NŮŽ NA GINGIVECTOMII
GINGIVECTOMY KNIFE
GINGIVECTOMIE-MESSER
112 50 0070
17,3 cm
Fig. 2

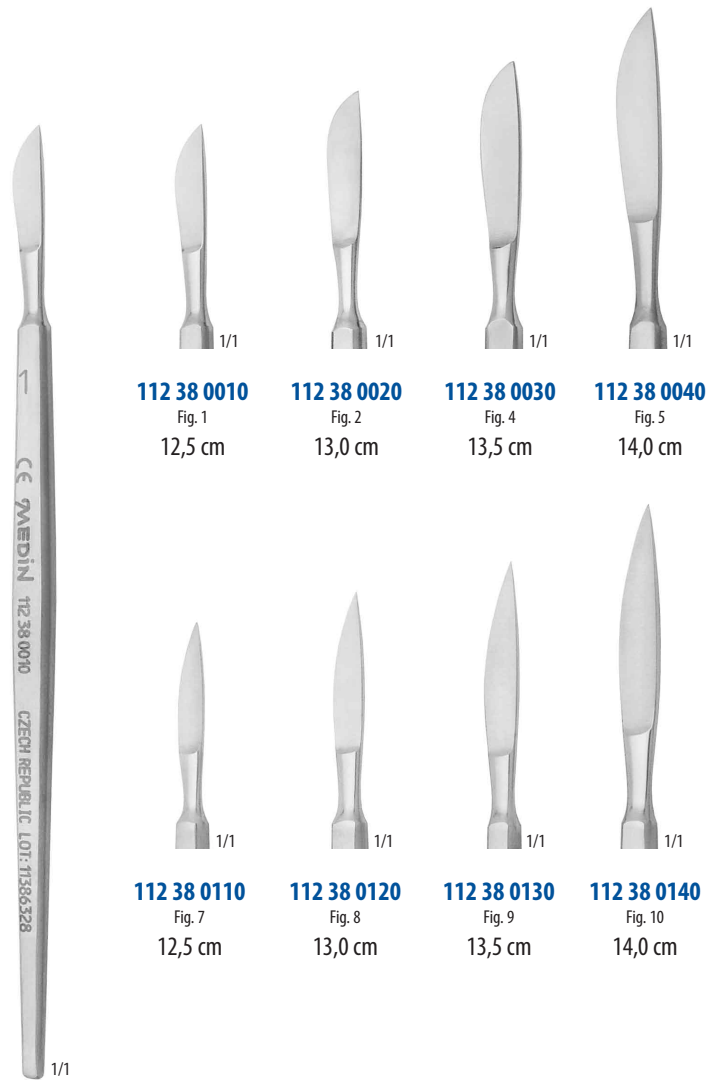

112 38 0010
Fig. 1
12,5 cm

112 38 0020
Fig. 2
13,0 cm

112 38 0030
Fig. 4
13,5 cm

112 38 0040
Fig. 5
14,0 cm

112 38 0110
Fig. 7
12,5 cm

112 38 0120
Fig. 8
13,0 cm

112 38 0130
Fig. 9
13,5 cm

112 38 0140
Fig. 10
14,0 cm

DIEFFENBACH
12,5 cm



112 91 0002
12,3 cm
Fig. 3



112 91 0003
12,3 cm
Fig. 3



112 91 0004
13,3 cm
Fig. 4



112 91 0005
20,5 cm
Fig. 3L



112 08 0696
15,0 cm



UTAHOVACÍ KLÍČEK
SPANNER
ANZUGSSCHLÜSSEL
112 08 0700
8,0 cm

**112 91 0010**

Fig. 10

**112 91 0011**

Fig. 11

**112 91 0012**

Fig. 12

**112 91 0025**

Fig. 12d

**112 91 0013**

Fig. 13

**112 91 0015**

Fig. 15

**112 91 0026**

Fig. 15c

pro držátka
for handles
passend für die Griffe

112 91 0002
112 91 0003
112 91 0005
112 91 0007
112 91 0008

**112 91 0018**

Fig. 18

**112 91 0019**

Fig. 19

**112 91 0020**

Fig. 20

**112 91 0021**

Fig. 21

**112 91 0022**

Fig. 22

**112 91 0023**

Fig. 23

**112 91 0024**

Fig. 24

pro držátka
for handles
passend für die Griffe

112 91 0004
112 91 0006
112 08 0650

POZNÁMKY: sterilní, balení 100 ks
NOTES: sterile, packing 100 pcs
ANMERKUNGEN: steril, Verpackung 100 Stk

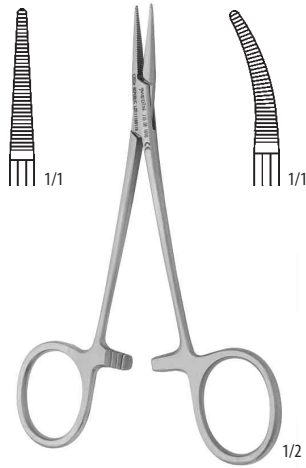
MOSQUITO-HALSTED

standard – standard – Standard

115 08 0010

12,0 cm

115 08 0020

12,0 cm

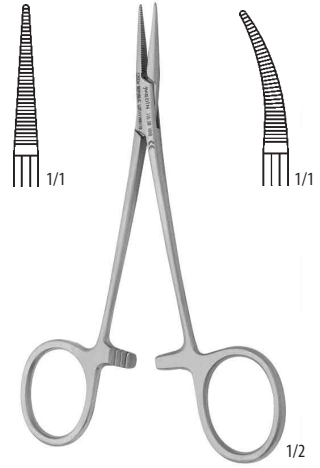
MOSQUITO-HALSTED

jemné – fine – fein

115 08 1010

12,0 cm

115 08 1020

12,0 cm

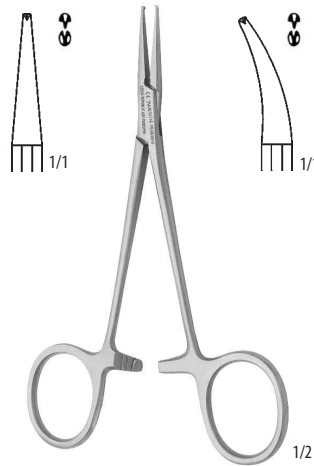
MOSQUITO-HALSTED

hladká čelist – smooth jaw – glatt

115 08 0040

12,0 cm

115 08 0060

12,0 cm

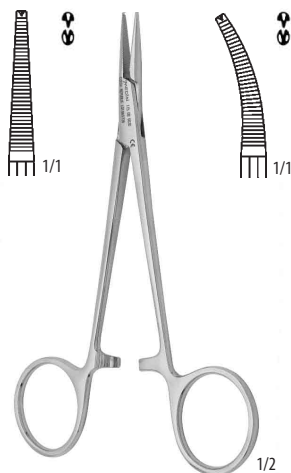
MOSQUITO-HALSTED

standard – standard – Standard

115 08 0030

12,0 cm

115 08 0050

12,0 cm

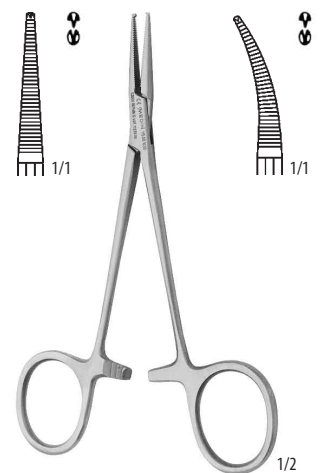
MOSQUITO-HALSTED

jemné – fine – fein

115 08 1030

12,0 cm

115 08 1050

12,0 cm

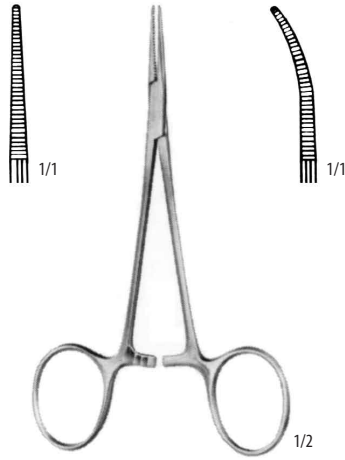
**MICRO-MOSQUITO****115 91 0073**

12,0 cm

115 91 0075

12,0 cm

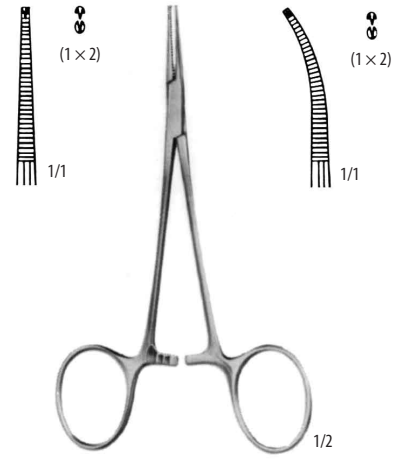
**MICRO-MOSQUITO****115 91 0077**

12,0 cm

115 91 0079

12,0 cm

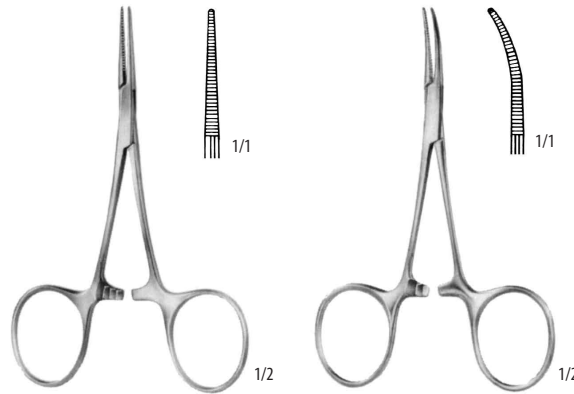
**HARTMANN****115 91 0068**

10,0 cm

115 91 0069

10,0 cm

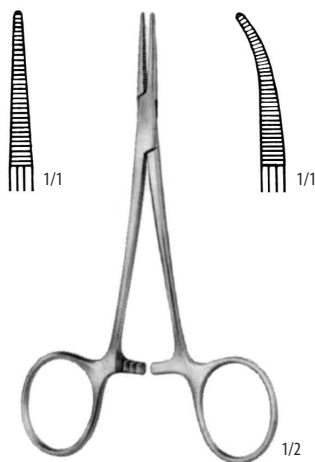
**HALSTEAD-MOSQUITO****115 91 0080**

12,5 cm

115 91 0082

12,5 cm

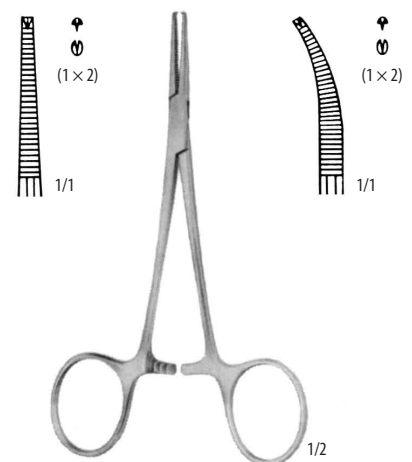
**HALSTEAD-MOSQUITO****115 91 0084**

12,5 cm

115 91 0086

12,5 cm

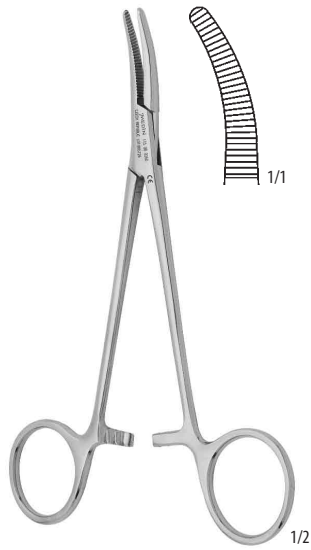

ROCHESTER-PEAN

zahnutá – curved – gebogen

115 08 0260

14,0 cm

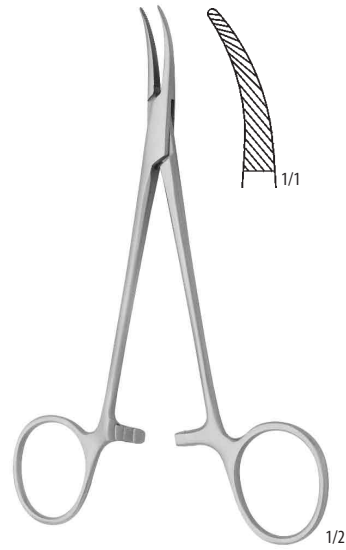

KELLY

zahnutá – curved – gebogen

115 08 0500

14,0 cm

SVORKA CHIRURGICKÁ
TISSUE FORCEPS
CHIRURGISCHE KLEMME

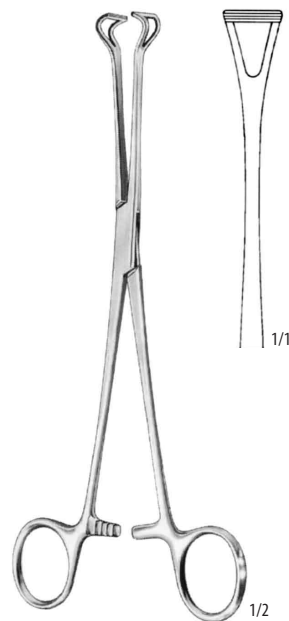

BABCOCK

115 91 0382

16,0 cm



BACKHAUS
115 08 0780
11,8 cm



BACKHAUS
115 08 0790
12,0 cm



BACKHAUS-CLIP
115 91 0341
11,0 cm



BACKHAUS
115 91 0343 – 11,0 cm
115 91 0345 – 15,0 cm



BACKHAUS
115 08 0810 – 8,0 cm
115 08 0820 – 13,0 cm



ROEDER

115 91 0348 – 13,0 cm

115 91 0349 – 15,0 cm

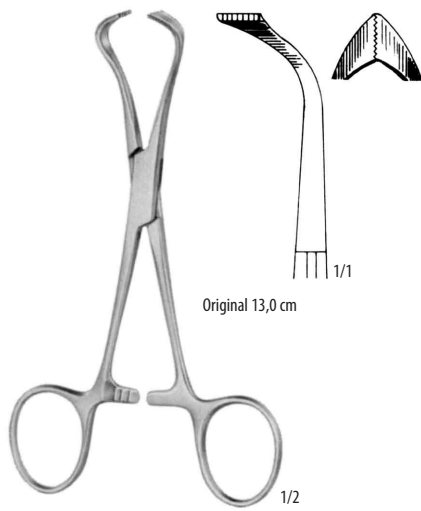

LORNA

115 91 0350 – 10,0 cm

115 91 0351 – 13,0 cm

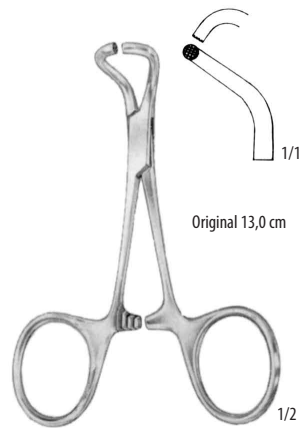

TOHOKU-JAPAN

115 91 0352 – 10,0 cm

115 91 0353 – 13,0 cm

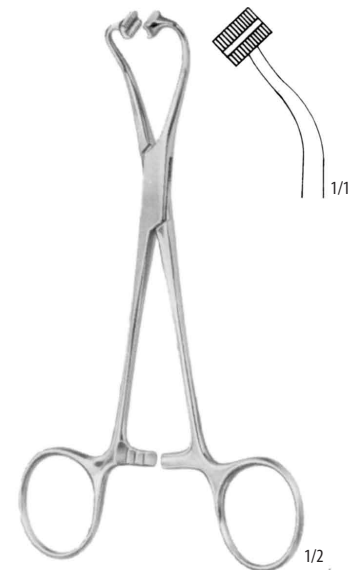

PEERS

115 91 0354

14,5 cm

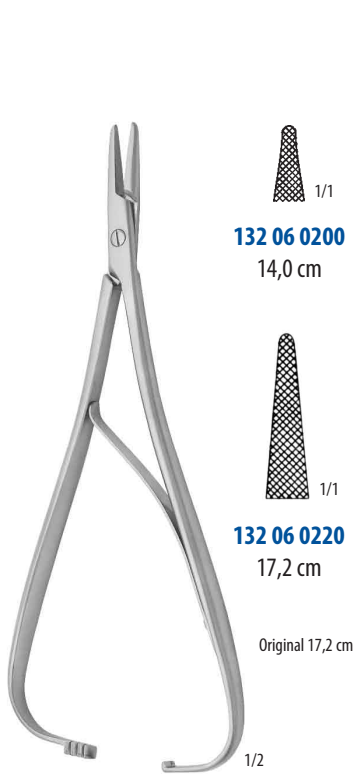

MATHIEU

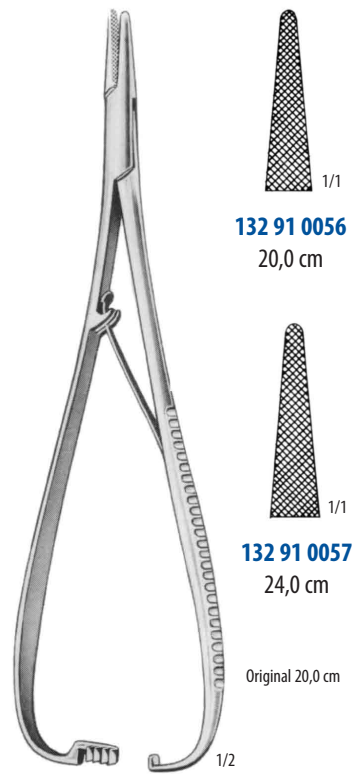

MATHIEU

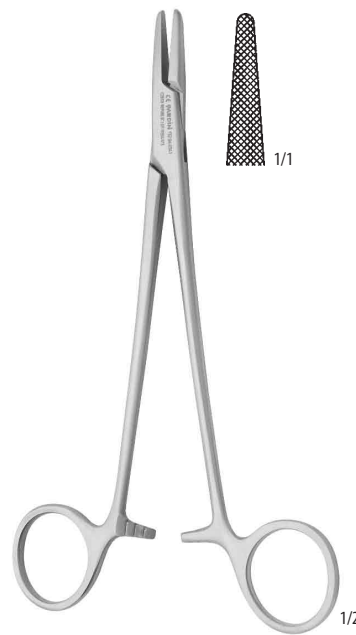

CRILE

132 06 0810
20,5 cm132 06 0341
16,5 cmBOYNTON
132 38 0120
12,5 cm



Original 19,0 cm

OLSEN-HEGAR

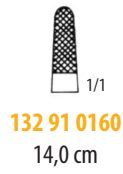

132 06 0610
16,5 cm

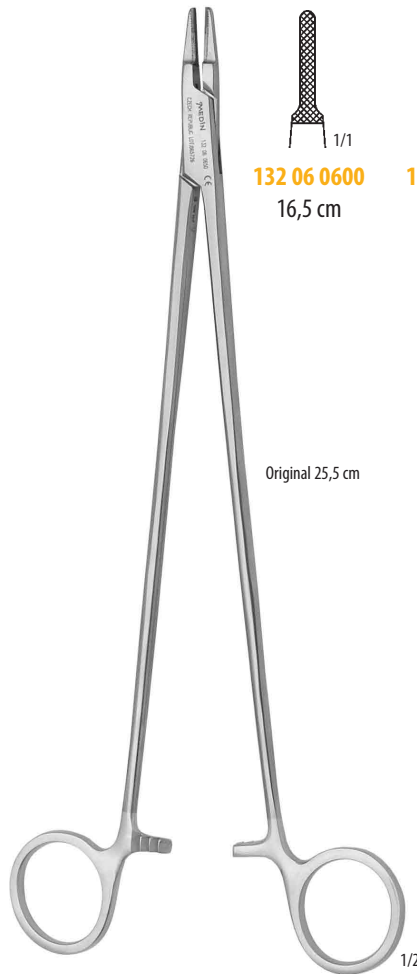

Original 25,5 cm

RYDER/FRENCH-EYE
132 06 0650
25,5 cm

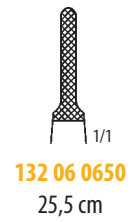

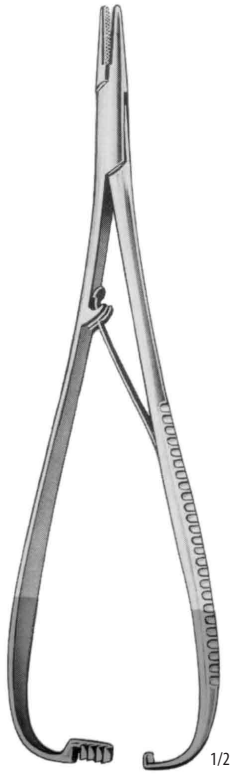

MATHIEU

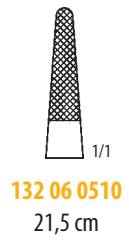

Original 21,5 cm



MATHIEU



Original 20,0 cm

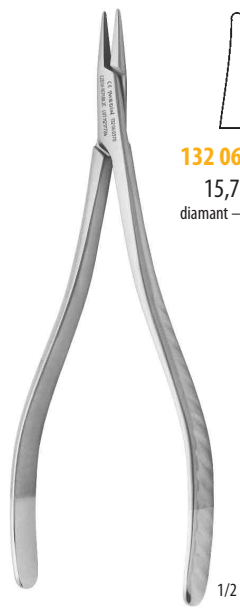
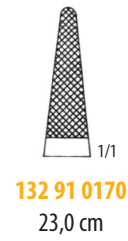

CRILE

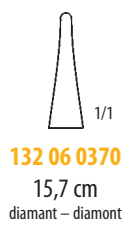

CRILE



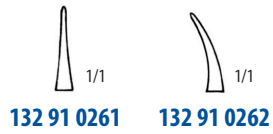

132 91 0261

132 91 0262

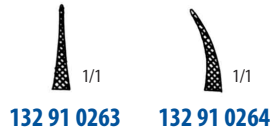

132 91 0263

132 91 0264

CASTROVIEJO
14,0 cm

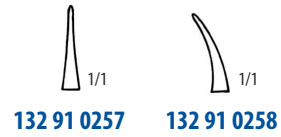
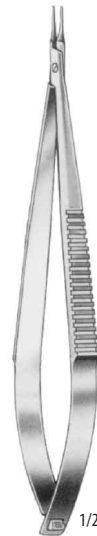

132 91 0257

132 91 0258

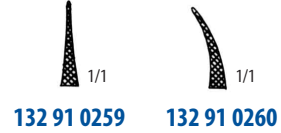

132 91 0259

132 91 0260

CASTROVIEJO
14,0 cm

MIKRO JEHELCE TVRDOKOVOVÉ
MICRO-NEEDLE HOLDERS WITH TUNGSTEN CARBIDE INSERT
MIKRONADELHALTER MIT HM-EINSATZ



132 91 0219



132 91 0220

CASTROVIEJO
18,0 cm

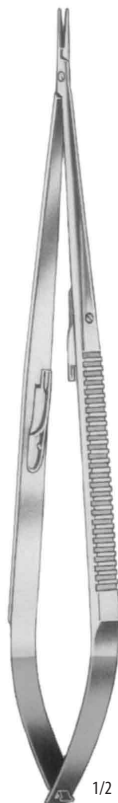

132 91 0221



132 91 0222

JACOBSON
21,0 cm



132 91 0215



132 91 0216

CASTROVIEJO
14,0 cm



LUNIATSCHEK
132 50 0180
17,0 cm



LUNIATSCHEK
132 50 0186
16,8 cm



LUNIATSCHEK
132 56 0186
16,8 cm



LUNIATSCHEK
132 50 0196
žlábkový – grooved – hohl
16,8 cm



LUNIATSCHEK
132 56 0196
žlábkový – grooved – hohl
16,8 cm



1/1

129 51 0100

15,2 cm



LISTER
113 05 0040
20,0 cm



NŮŽKY NA MĚKKÉ OBVAZY
PLASTER SCISSORS
VERBANDSCHERE
113 05 0210
23,5 cm

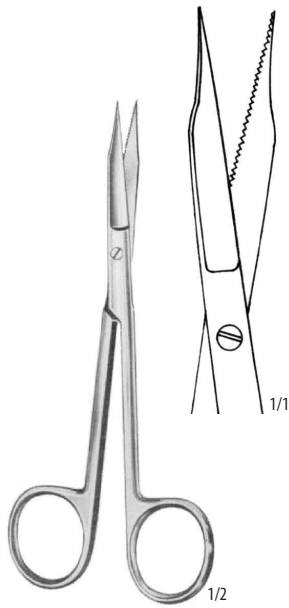

GOLDMANN-FOX
113 91 0474

13,0 cm
se zuby – saw edge – schneide gezahnt
rovné – straight – gerade

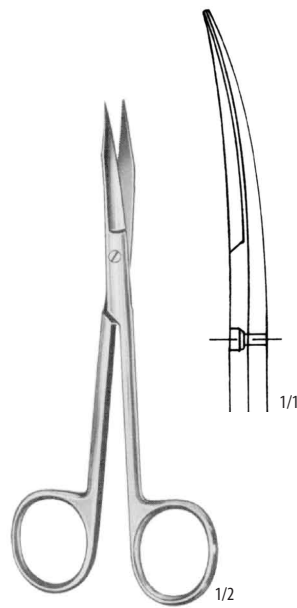

GOLDMANN-FOX
113 91 0475

13,0 cm
se zuby – saw edge – schneide gezahnt
zahnuté – curved – gebogen

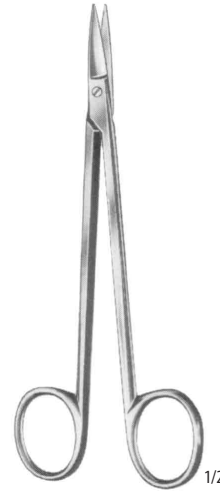

QUINBY
113 91 0483

12,0 cm
rovné – straight – gerade

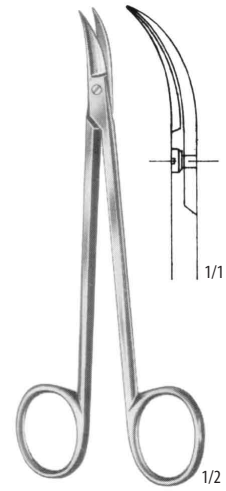

QUINBY
113 91 0484

12,0 cm
zahnuté – curved – gebogen

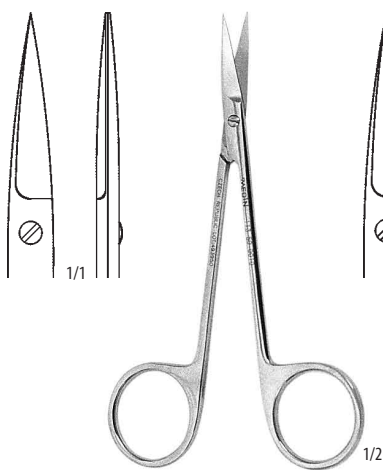

113 50 0010

12,0 cm
rovné – straight – gerade

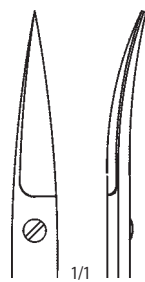

113 50 0020

12,0 cm
zahnuté – curved – gebogen



113 50 0030

14,5 cm
rovné – straight – gerade

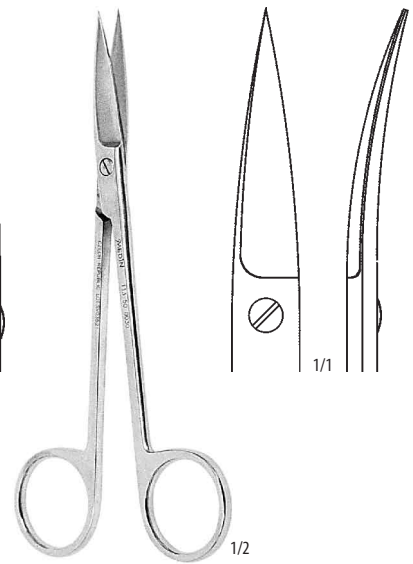

113 50 0040

14,5 cm
zahnuté – curved – gebogen

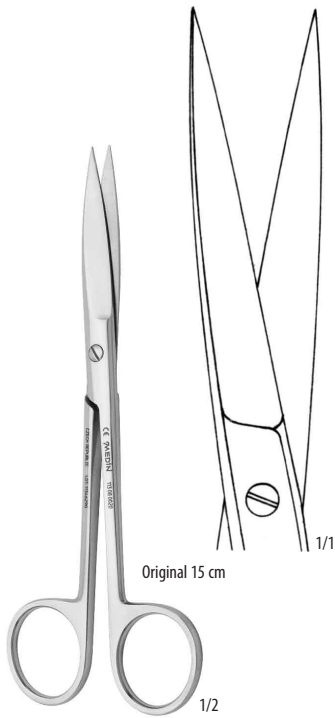

STANDARD

rovné
straight
gerade

113 91 0042	– 11,5 cm –	113 91 0051
113 08 0010	– 13,0 cm –	113 08 0310
113 08 0020	– 15,0 cm –	113 08 0320
113 91 0046	– 16,5 cm –	113 91 0055
113 08 0040	– 18,5 cm –	113 08 0340
113 91 0049	– 20,0 cm –	113 91 0058
113 08 0060	– 22,0 cm –	113 08 0360
113 08 0070	– 30,0 cm –	113 08 0370

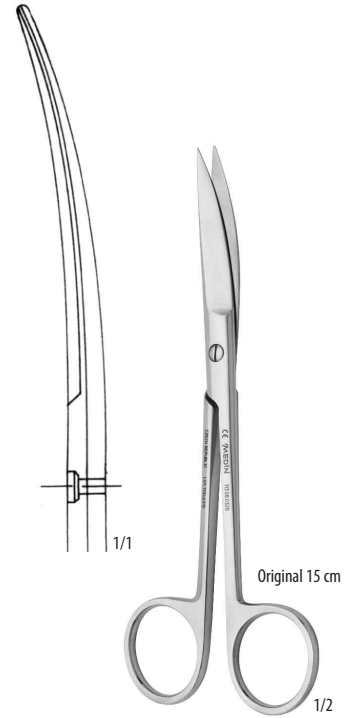
zahnuté
curved
gebogen

STANDARD

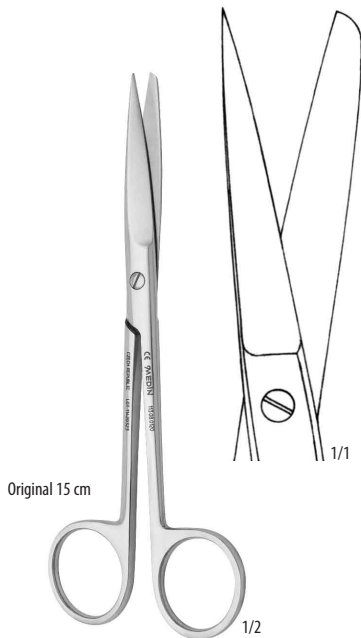

STANDARD

rovné
straight
gerade

113 91 0020	– 11,5 cm –	113 91 0031
113 08 0110	– 13,0 cm –	113 08 0410
113 08 0120	– 15,0 cm –	113 08 0420
113 91 0026	– 16,5 cm –	113 91 0037
113 08 0140	– 18,5 cm –	113 08 0440
113 91 0029	– 20,0 cm –	113 91 0040
113 08 0160	– 22,0 cm –	113 08 0460
113 08 0170	– 30,0 cm –	113 08 0470

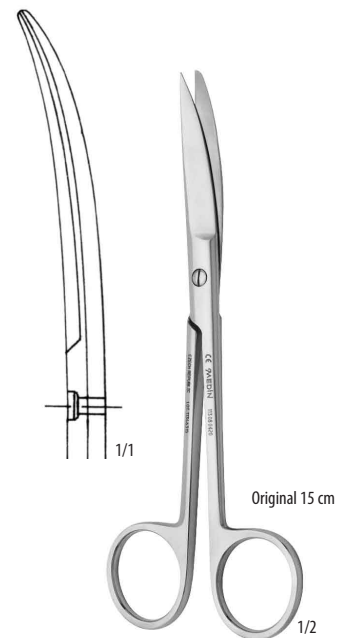
zahnuté
curved
gebogen

STANDARD

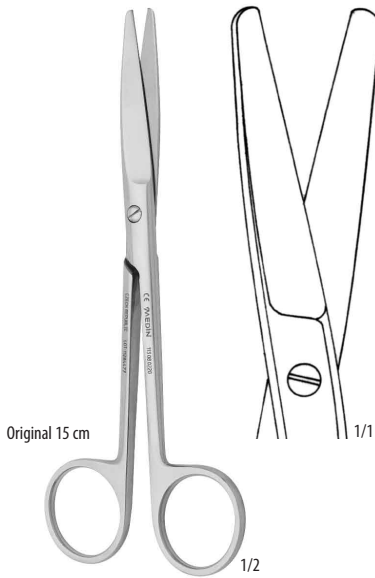

STANDARD

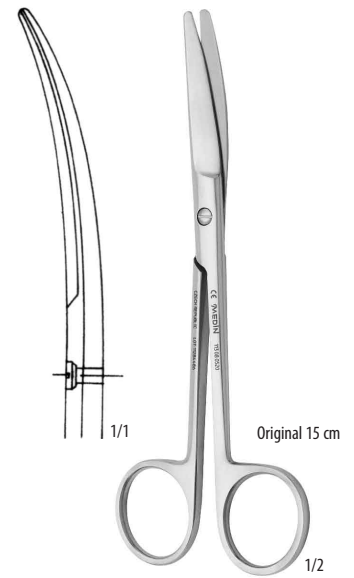
rovné straight gerade		zahnuté curved gebogen	
113 91 0002	– 11,5 cm –	113 91 0011	
113 08 0210	– 13,0 cm –	113 08 0510	
113 08 0220	– 15,0 cm –	113 08 0520	
113 91 0006	– 16,5 cm –	113 91 0015	
113 08 0240	– 18,5 cm –	113 08 0540	
113 91 0009	– 20,0 cm –	113 91 0018	
113 08 0260	– 22,0 cm –	113 08 0560	
113 08 0270	– 30,0 cm –	113 08 0570	

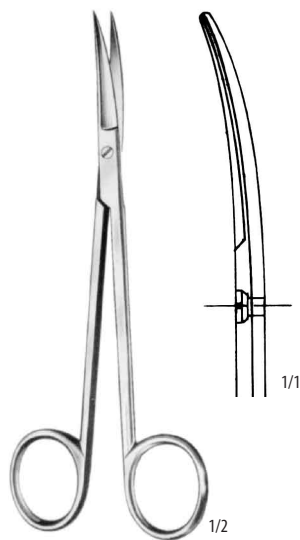

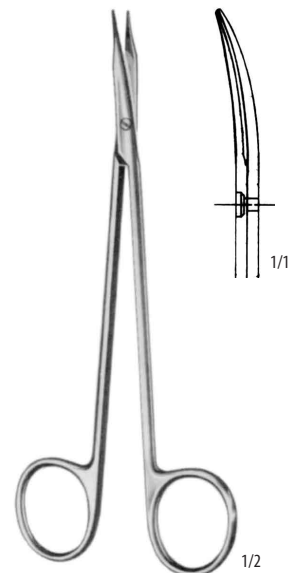
STANDARD
NŮŽKY PREPARAČNÍ
DISSECTING SCISSORS
PRAEPARIERSCHERE

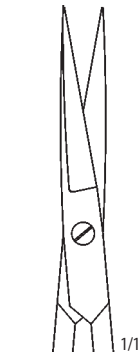
SANVENERO
 rovné – straight – gerade
113 91 0221
 14,0 cm

SANVENERO
 zahnuté – curved – gebogen
113 91 0222
 14,0 cm

REYNOLDS
113 91 0233
 rovné – straight – gerade
 15,0 cm

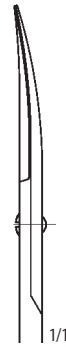
REYNOLDS
113 91 0235
 zahnuté – curved – gebogen
 15,0 cm



rovnné – straight – gerade

113 38 0010 – 10,0 cm – **113 38 0040****113 38 0071** – 11,5 cm – **113 38 0091**

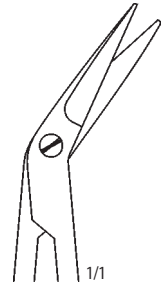
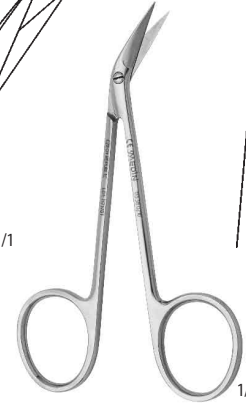
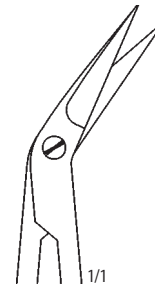
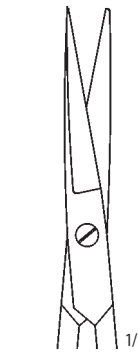
zahnuté – curved – gebogen

**113 38 0210** – 10,5 cm – **113 38 0260**

rovnné – straight – gerade

113 38 0020 – 10,0 cm – **113 38 0050****113 38 0150** – 11,5 cm – **113 38 0100**

zahnuté – curved – gebogen

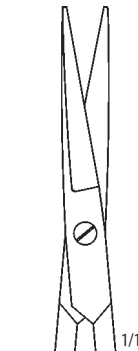

rovnné – straight – gerade

113 38 0030 – 10,0 cm – **113 38 0060****113 38 0081** – 11,5 cm – **113 38 0161**

zahnuté – curved – gebogen

**113 38 0311**

11,5 cm

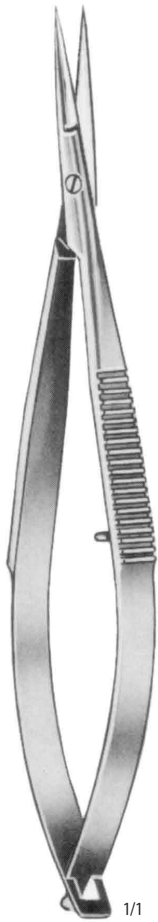

NOYES
12,0 cm



113 91 0490



113 91 0492



113 91 0494

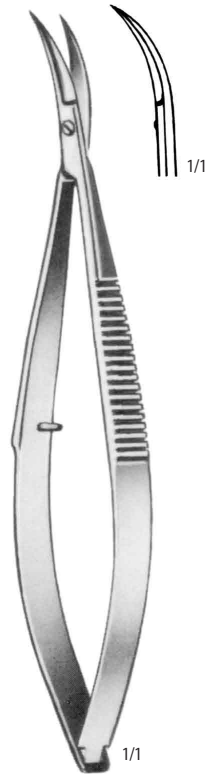

CASTROVIEJO
113 91 0507
10,0 cm

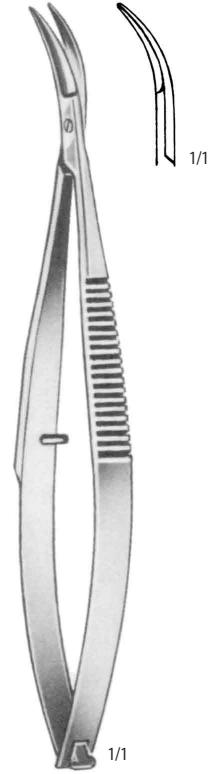

CASTROVIEJO
113 91 0508
10,0 cm

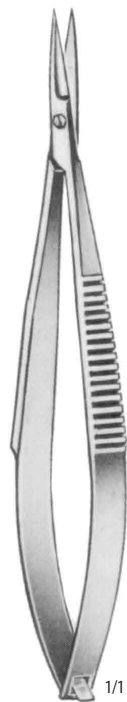

CASTROVIEJO
113 91 0502
9,0 cm



113 91 0503

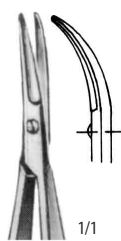

113 38 1020



113 91 0505



113 38 1030

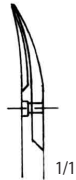

113 91 0537

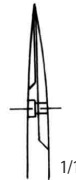

113 91 0539

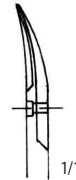

113 91 0538



113 91 0540

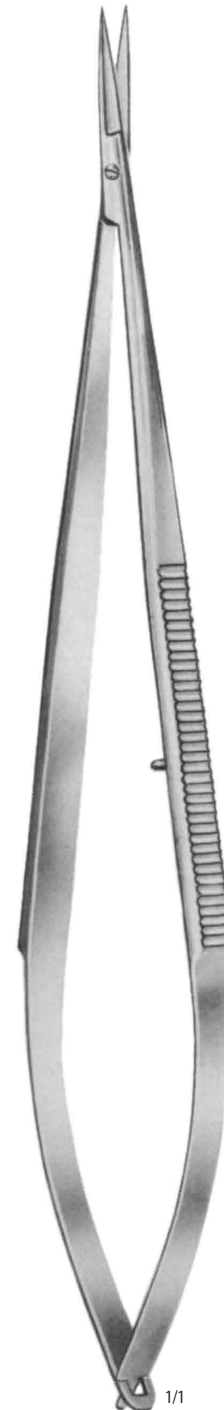

113 91 0552



113 91 0553

GOMEL
14,5 cm

GOMEL
18,0 cm

18,5 cm

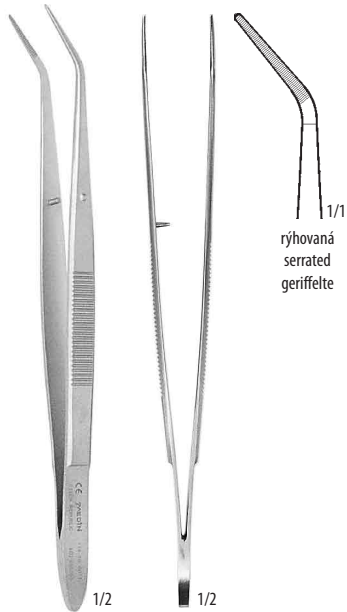

114 50 0011
 zahnutá – curved – gebogen
 15,7 cm

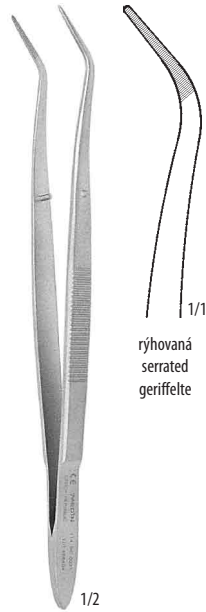

114 50 0021
 lomená – angled – gebogen
 15,7 cm

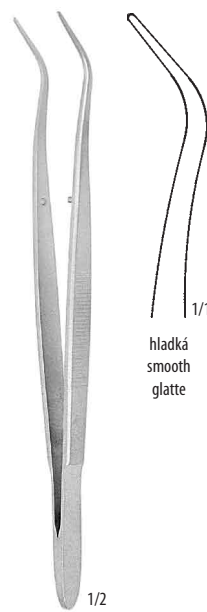

114 50 0031
 lomená – angled – gebogen
 15,7 cm

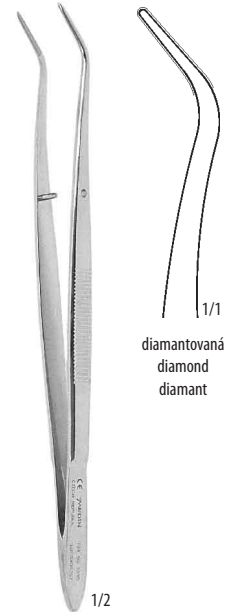

114 50 1030
 lomená – angled – gebogen
 15,7 cm

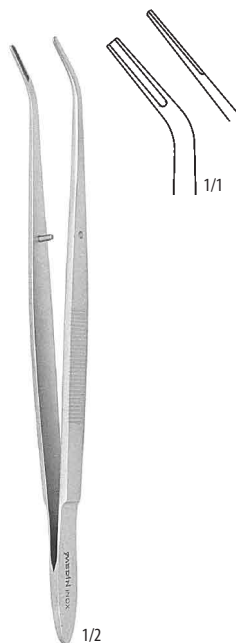

114 50 0051
 15,7 cm

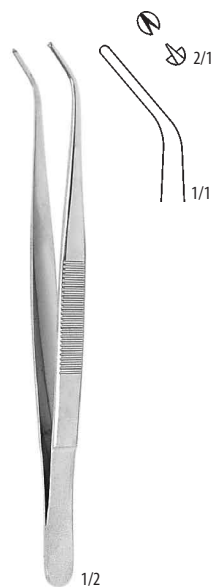

114 50 0150
 zahnutá, jemná – curved, fine – gebogen, fein
 14,2 cm

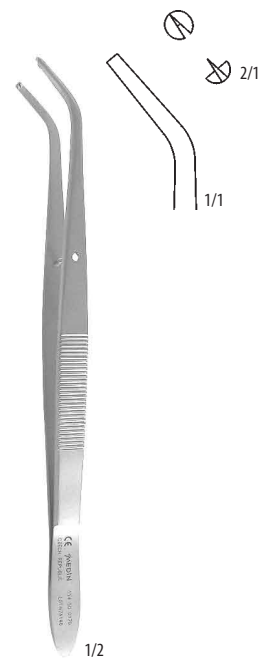

114 50 0170
 zahnutá – curved – gebogen
 15,7 cm



114 08 0090
14,5 cm



114 08 0101
jemná – fine – fein
14,5 cm



114 08 0231
velmi jemná – very fine – sehr fein
14,5 cm



114 08 0140
jemná – fine – fein
20,0 cm



114 08 0240
velmi jemná – very fine – sehr fein
20,0 cm



114 08 0250
24,5 cm



Original 14,5 cm

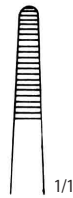
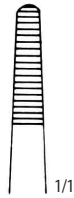
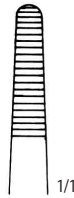
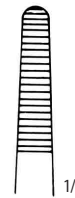
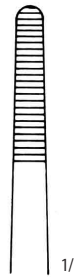
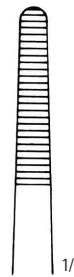
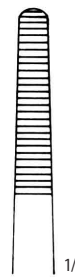
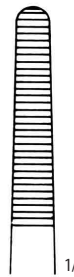

114 91 0002

114 91 0003

114 91 0004

114 08 0030

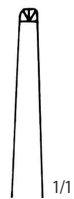
114 91 0006

114 08 0040

114 08 0050

114 08 0060

- 114 91 0002** – 11,5 cm
- 114 91 0003** – 13,0 cm
- 114 91 0004** – 14,5 cm
- 114 08 0030** – 16,0 cm
- 114 91 0006** – 18,0 cm
- 114 08 0040** – 20,0 cm
- 114 08 0050** – 25,0 cm
- 114 08 0060** – 30,0 cm

STANDARD



Original 14,5 cm

114 91 0011

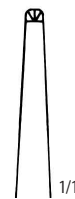
114 91 0012

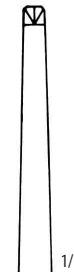
114 08 0381

114 08 0430

114 91 0015

114 08 0340

114 08 0350

114 08 0360

- 114 91 0011** – 11,5 cm
- 114 91 0012** – 13,0 cm
- 114 08 0381** – 14,5 cm
- 114 08 0430** – 16,0 cm jemná – fine – fein
- 114 91 0015** – 18,0 cm
- 114 08 0340** – 20,0 cm
- 114 08 0350** – 25,0 cm
- 114 08 0360** – 30,0 cm

STANDARD



114 91 0477
14,0 cm

1/1

114 91 0478
16,0 cm

1/1

114 91 0479
18,0 cm

1/1

Original 18,0 cm

114 91 0480
20,0 cm

1/1

114 91 0481
25,0 cm

1/1

114 91 0482
30,0 cm

1/1

1/2

OEHLER



Original 12,0 cm

114 91 0487
12,0 cm

1/1

114 91 0490
12,0 cm

1/1

114 91 0489
15,0 cm

1/1

114 91 0491
15,0 cm

1/1

ADSON



Original 12,5 cm

SEMKEN
114 91 0483 12,5 cm
114 91 0484 15,5 cm

1/2

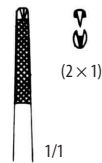

GILLIES
114 91 0485
15,0 cm

1/2



JEWELER
114 91 0486
15,0 cm

1/2

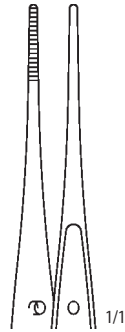
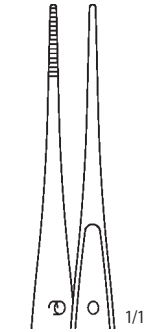
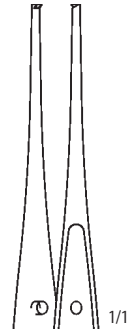
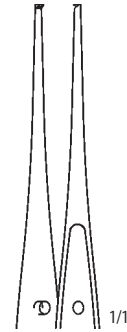
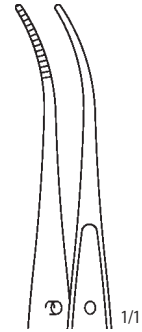

1/1

GRAEFE
 10,5 cm

114 38 0010

114 38 0020
 jemná – fine – fein

114 38 0150

114 38 0160
 jemná – fine – fein

114 38 0100
 jemná – fine – fein

1/1

 se zámkem
 with lock
 mit Schloss

1/1

GRAEFE
114 38 0360
 11,0 cm



PINZETA LABORATORNÍ
CROSS-ACTION FORCEPS
LÖTPINZETTEN
114 52 0100
15,3 cm



PINZETA LABORATORNÍ
CROSS-ACTION FORCEPS
LÖTPINZETTEN
114 52 0101
15,3 cm

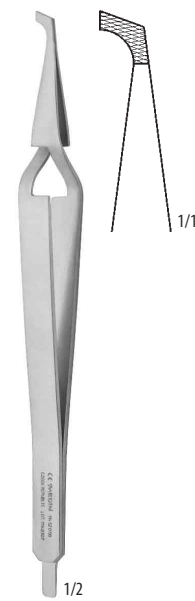

PINZETA ZKŘÍŽENÁ SE ŠROUBOVÁKEM
CROSS-ACTION FORCEPS WITH SCREWDRIVER
LÖTPINZETTEN MIT SCHRAUBENZIEHER
114 52 0110
15,5 cm

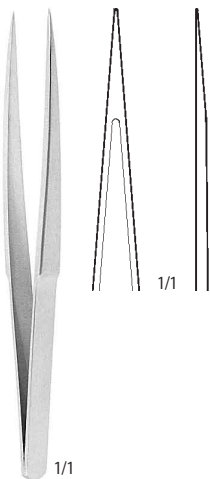

PINZETA LABORATORNÍ
LABORATORY FORCEPS
LABORPINZETTE
114 52 0020
hrotnatá – pointed – spitzen
12,5 cm

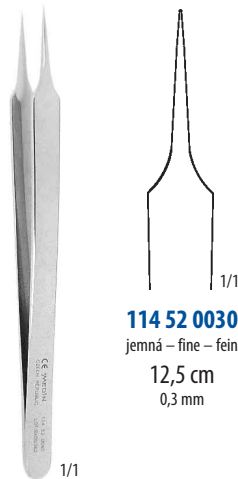

PINZETA LABORATORNÍ
LABORATORY FORCEPS
LABORPINZETTE
114 52 0030
12,5 cm

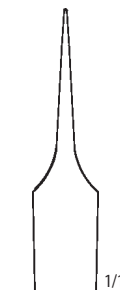

114 52 0030
jemná – fine – fein
12,5 cm
0,3 mm

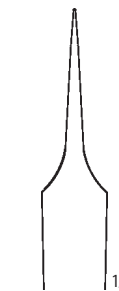

114 52 0040
jemná – fine – fein
12,5 cm
0,4 mm

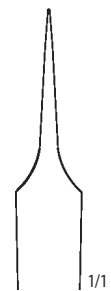

114 52 0050
jemná – fine – fein
11,0 cm
0,3 mm

114 52 0060
jemná – fine – fein
11,0 cm
0,4 mm



SONDY, PÁTRADLA	PROBES	SONDEN	71
LOPATKY	SPATULAS	SPATELN	72
ZRCÁTKA	MIRRORS	MUNDSPIEGEL	73
STOMATOLOGICKÉ SOUBORY	STOMATOLOGICAL SETS	DENTAL-SÄTZE	74

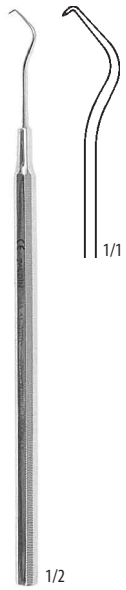

133 51 0010
 háčkové, krátké
 short hooked
 häkchen, kurz
 15,2 cm



133 51 0016
 háčkové, krátké
 short hooked
 häkchen, kurz
 15,2 cm

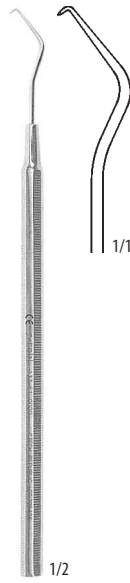

133 51 0020
 háčkové, dlouhé
 long hooked
 häkchen, lang
 15,1 cm



133 51 0026
 háčkové, dlouhé
 long hooked
 häkchen, lang
 15,1 cm

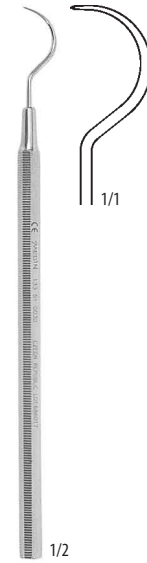

133 51 0030
 obloukové
 embowed
 gebogene
 14,5 cm



133 51 0036
 obloukové
 embowed
 gebogene
 14,5 cm



133 51 0040
 lomené, krátké
 short, angled
 gebogen, kurz
 15,0 cm



133 51 0046
 lomené, krátké
 short, angled
 gebogen, kurz
 15,0 cm

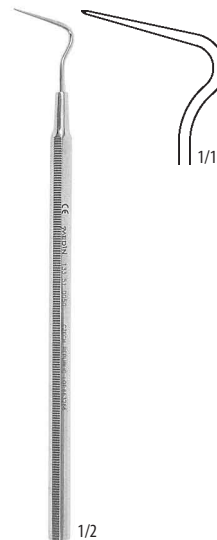

133 51 0050
 lomené, dlouhé
 long, angled
 gebogen, lang
 14,0 cm



133 51 0056
 lomené, dlouhé
 long, angled
 gebogen, lang
 14,0 cm



1/2

BUCHWALD
121 31 001017,3 cm
16/23 mm

1/2

BRÜNNINGS
121 31 002019,5 cm
14/18 mm



1/1

122 51 0010

1 : 1
ploché – plane – plan
Ø 2,4 cm



1/1

122 91 0333

1 : 1
ploché – plane – plan
zvýšená odrazivost – high reflection – besser Reflektionsfaktor
Ø 2,4 cm



1/1

122 51 0020

2,25×
zvětšovací – magnifying – hohl
Ø 2,4 cm



1/1

122 91 0408

1 : 1
ploché – plane – plan
Ø 1,4 cm

DRŽÁTKA ZUBNÍCH ZRCÁTEK
DENTAL MIRROR HANDLES
MUNDSPIEGELSGRIFFE



1/1

122 51 0100

12,0 cm
osmihranné držátko – octagonal handle – Achtkant-Griff
5,5 mm



1/1

122 51 0106

12,0 cm
plné držátko – round solid handle – Rundgriff massiv
Ø 6,0 mm



1/1

122 56 0106

12,0 cm
duté držátko – hollow handle – Hohlgriff
Ø 8,0 mm

**139 50 0120**

soubor – set – Set

22,0 × 10,5 × 3,6 cm

			počet ks – number of pcs – Anzahl
114 50 0011	PINZETA ZUBNÍ – zahnutá, rýhovaná	TWEEZER – curved, serrated	ZAHNPINZETTE – gebogen, gereift 1
122 51 0020	ZRCÁTKO ZUBNÍ – zvětšovací	DENTAL MIRROR – magnifying	MUNDSPIEGEL – hohl 1
122 51 0100	DRŽÁTKO ZUBNÍHO ZRCÁTKA	DENTAL HANDLE	DENTAL HANDLE 1
133 51 0050	PÁTRADLO ZUBNÍ – lomené, dlouhé	DENTAL PROBE – long, angled	ZAHNSOND – gebogen, lang 1
139 50 0150	DRŽÁK (aluminium)	HOLDER (aluminium)	GRIF (Aluminium) 1
139 50 0170	KAZETA (aluminium)	CASSETTE (aluminium)	KASSETTE (aluminium) 1
147 51 0040	SRPEK NA ZUBNÍ KÁMEN	SCALER	ZAHNREINIGER 1
148 51 0110	EXKAVÁTOR – oboustranný	EXCAVATOR – double-faced	EXKAVATOR – doppelendig 1



EXKAVÁTORY	EXCAVATORS	EXKAVATOREN	77–78
NÁSTROJE PRO VÝPLNĚ	FILLING INSTRUMENTS	FÜLLUNGSINSTRUMENTE	79–90
LOPATKY	SPATULAS	SPATELN	91
MATRICE	MATRIXES	MATRIZENBÄNDER	92–93
NÁSTROJE NA SNÍMÁNÍ KORUNEK	CROWN REMOVERS	KRONENABNEHMER	94

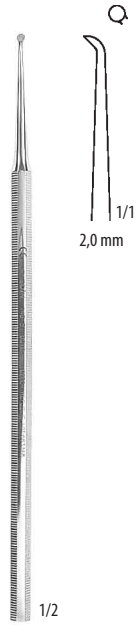

148 51 0010
 rovný – straight – gerade
 15,5 cm



148 51 0016
 rovný – straight – gerade
 15,5 cm



148 51 0026
 2,5 mm



148 51 0056
 pravý – right – rechts
 15,5 cm



148 51 0076
 levý – left – links
 15,5 cm

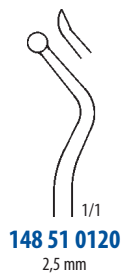
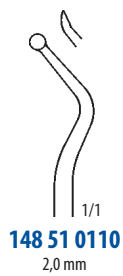
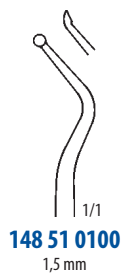

148 51 0100
oboustranný
double faced
doppellendig
17,0 cm

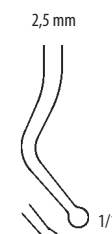

148 51 0106
oboustranný
double faced
doppellendig
16,8 cm

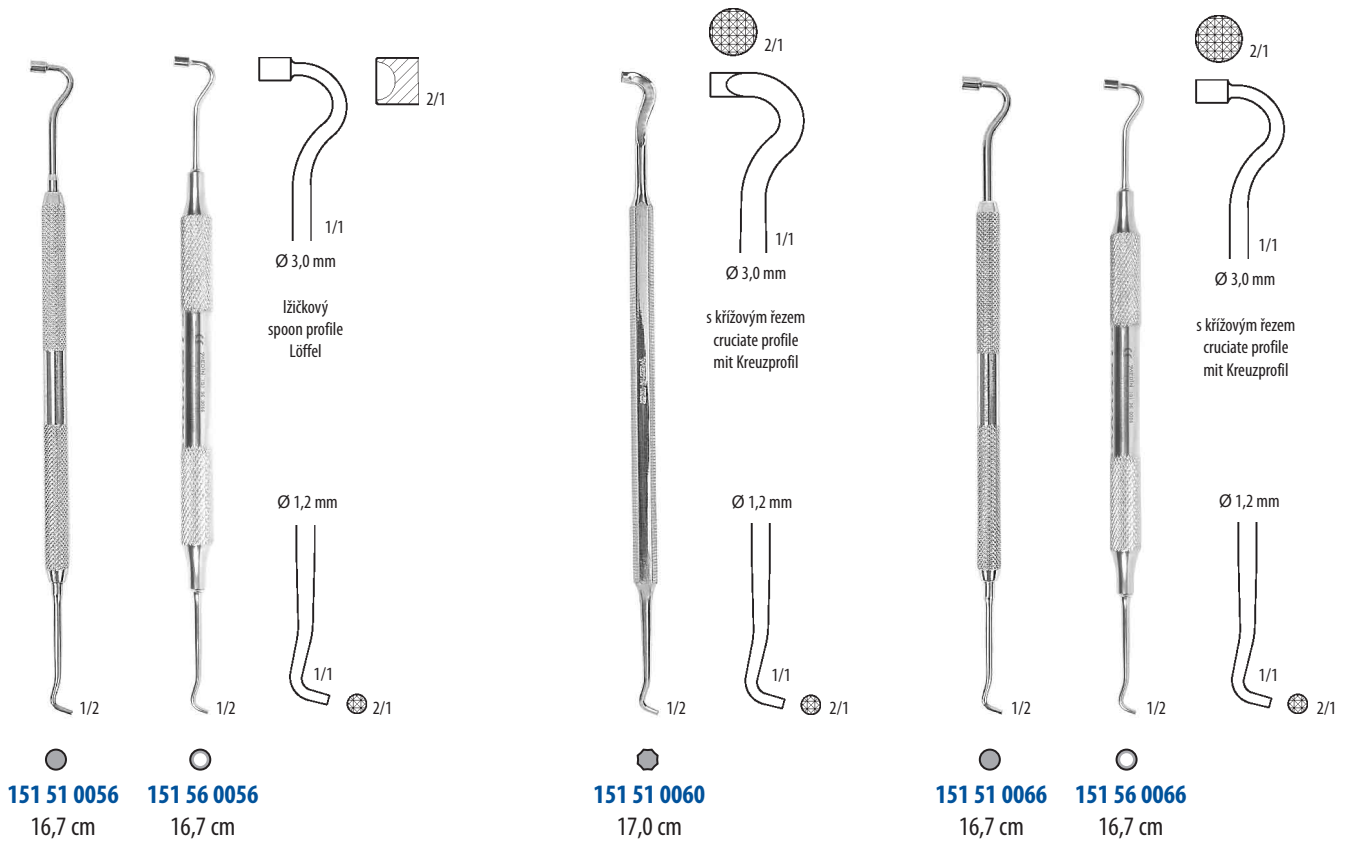
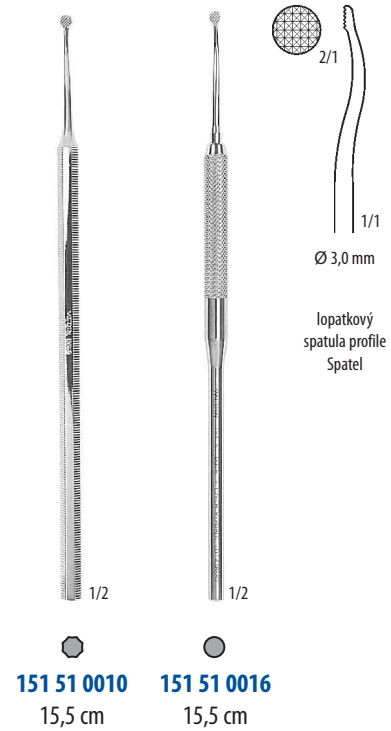
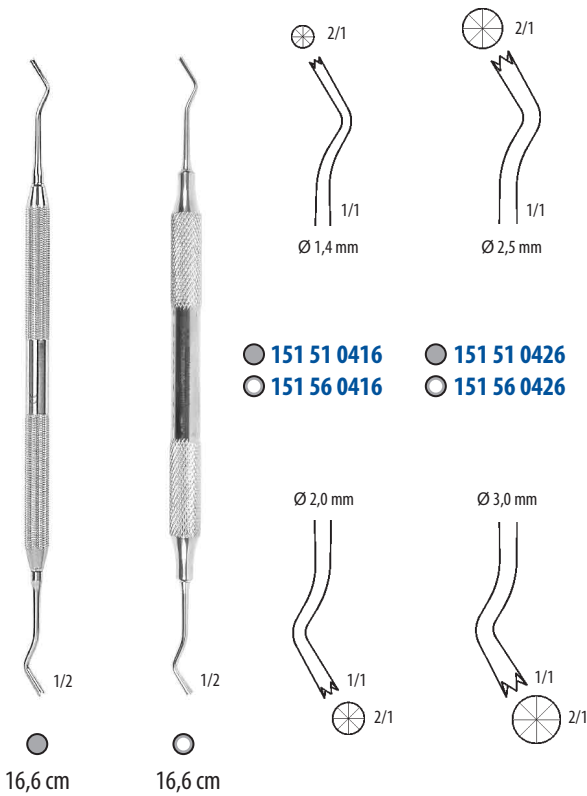

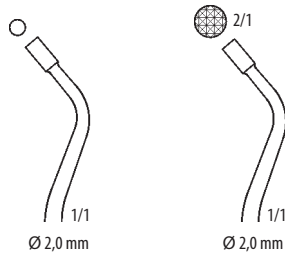

- 151 51 0096
 - 151 56 0096
 - 151 51 0097
 - 151 56 0097
- 151 51 0080
 - 151 51 0086
 - 151 56 0086

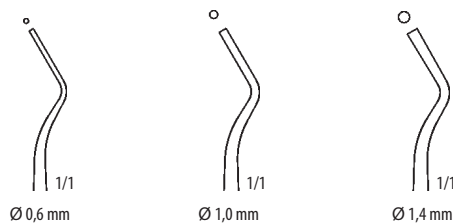
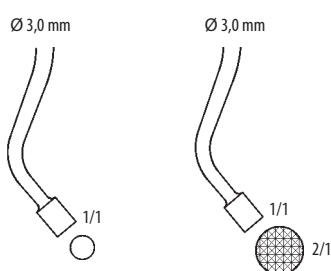

- 151 51 0306
 - 151 56 0306
 - 151 51 0280
 - 151 51 0286
 - 151 56 0286
 - 151 51 0290
 - 151 51 0296
 - 151 56 0296
- 151 51 0287
 - 151 56 0287
 - 151 51 0297
 - 151 56 0297

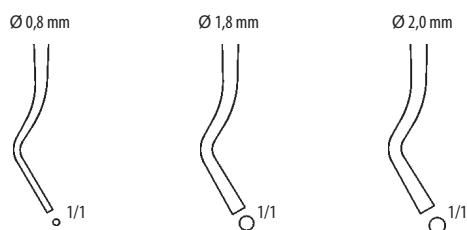

●	osmihranné držátko – octagonal handle – Achtkant-Griff	5,5 mm
●	plné držátko – round solid handle – Rundgriff massiv	Ø 6,0 mm
○	duté držátko – hollow handle – Hohlgriff	Ø 8,0 mm

151 5X XXXX

nerez – stainless steel – rostfreier Stahl

151 5X XXXX

TiN povlak – TiN surface – TiN Beschichtung

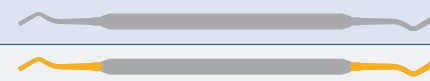

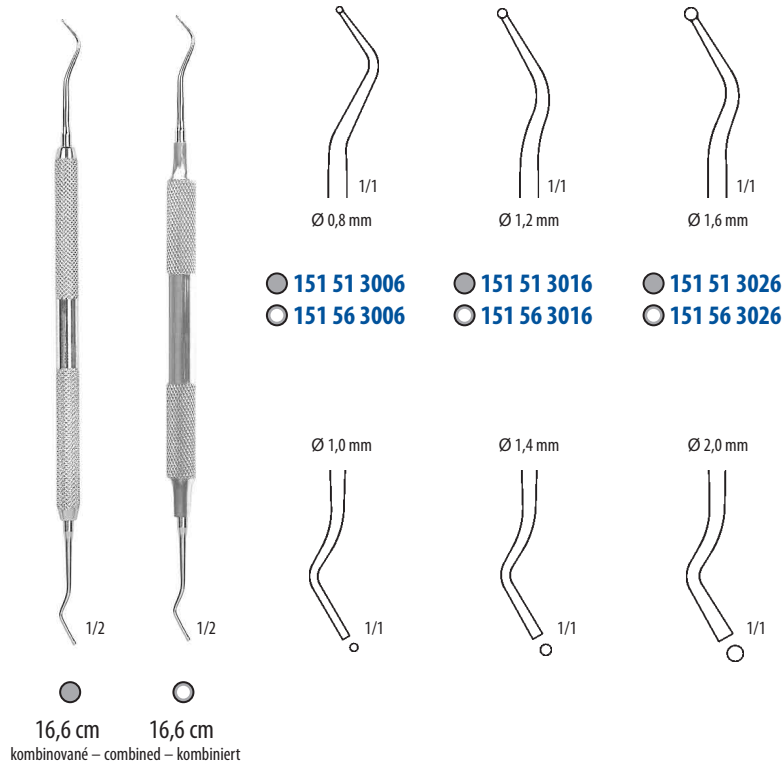
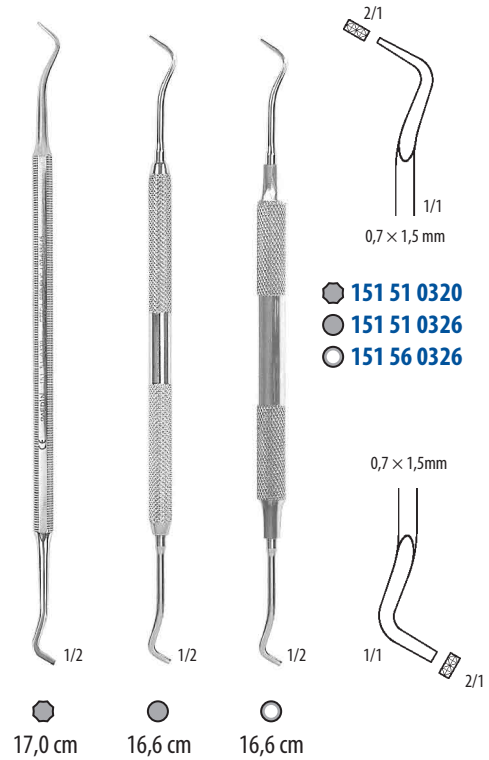
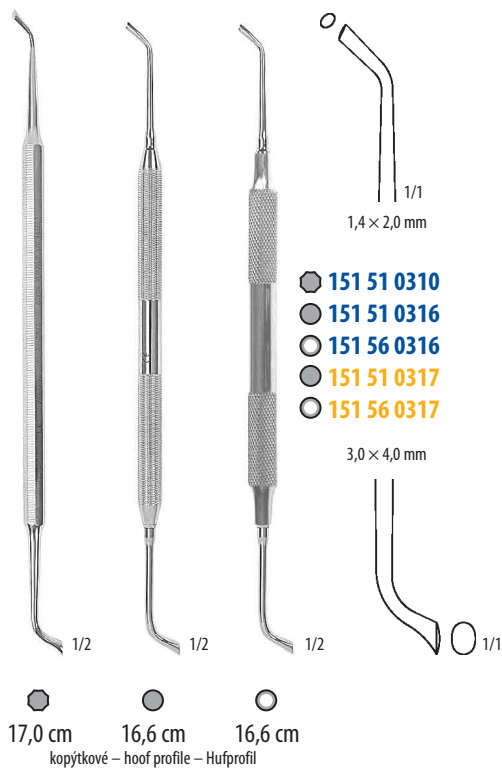

●	osmihránné držátko – octagonal handle – Achtkant-Griff	5,5 mm
●	plně držátko – round solid handle – Rundgriff massiv	Ø 6,0 mm
○	duté držátko – hollow handle – Hohlgriff	Ø 8,0 mm

151 5X XXXX	nerez – stainless steel – rostfreier Stahl	
151 5X XXXX	TiN povlak – TiN surface – TiN Beschichtung	

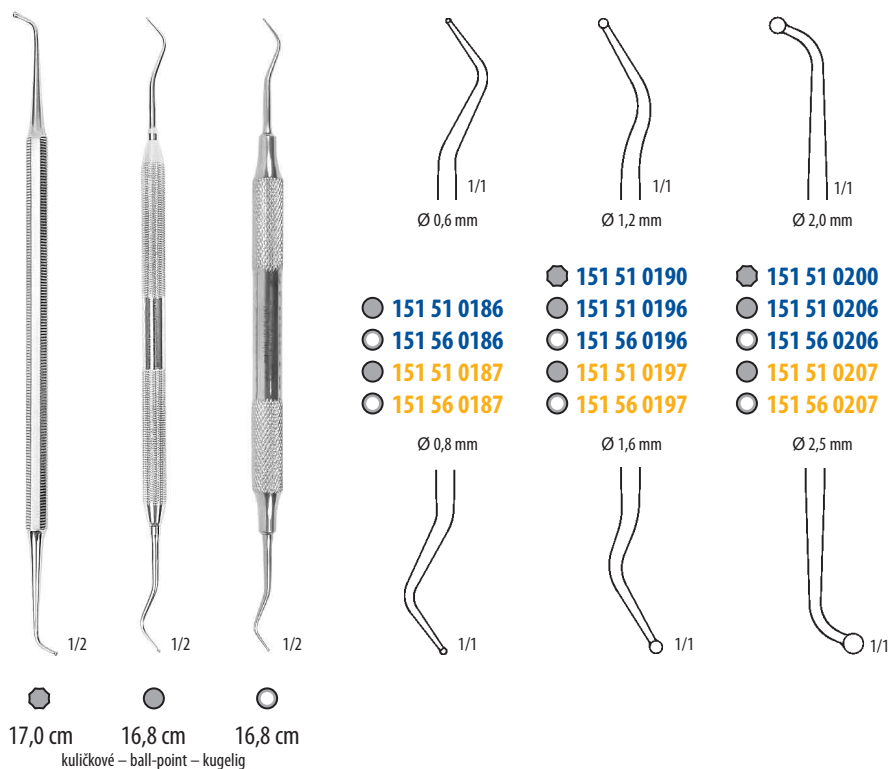
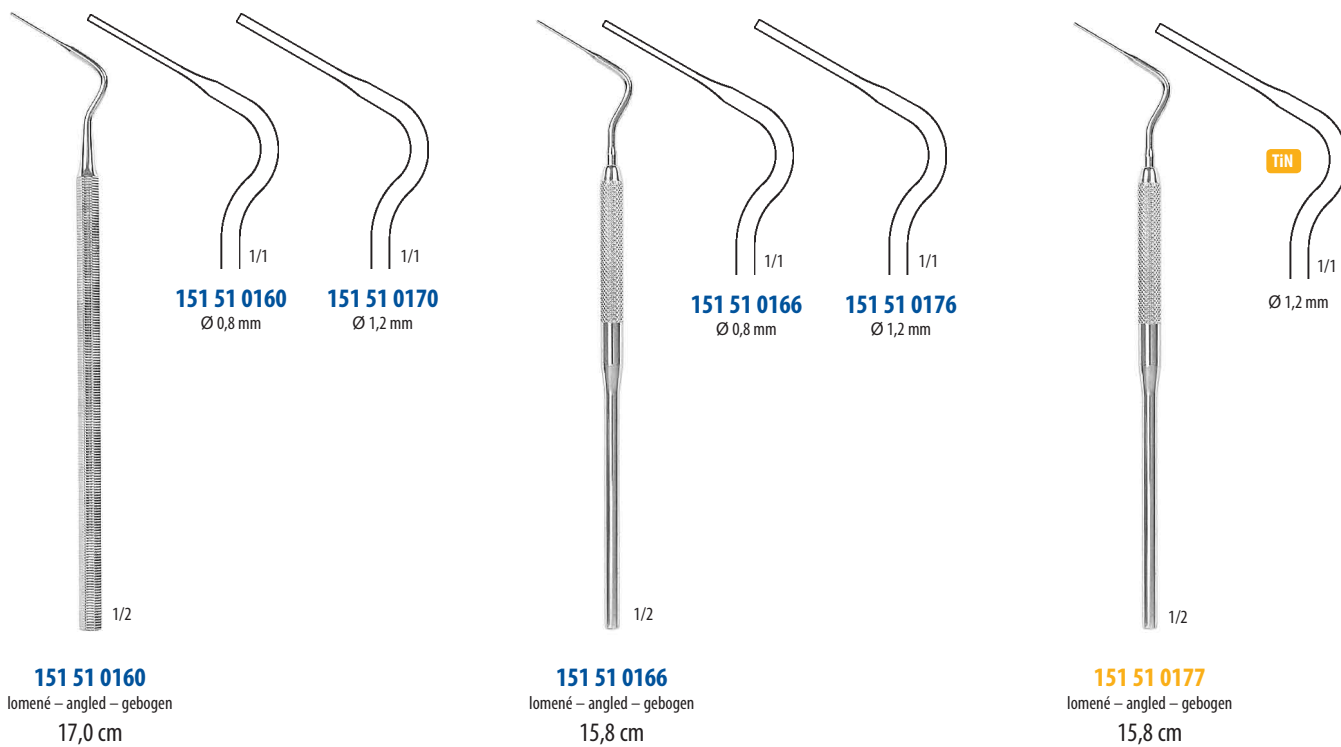
CPÁTKA
 FILLING INSTRUMENTS
 FÜLLUNGSTRUMENTE

 CPÁTKA KÖRENOVÁ
 FILLING INSTRUMENTS
 WURZELSTOPFER

	osmihránné držátko – octagonal handle – Achtkant-Griff	5,5 mm
	plné držátko – round solid handle – Rundgriff massiv	Ø 6,0 mm
	duté držátko – hollow handle – Hohlgriff	Ø 8,0 mm

151 5X XXXX

nerez – stainless steel – rostfreier Stahl

151 5X XXXX

TiN povlak – TiN surface – TiN Beschichtung

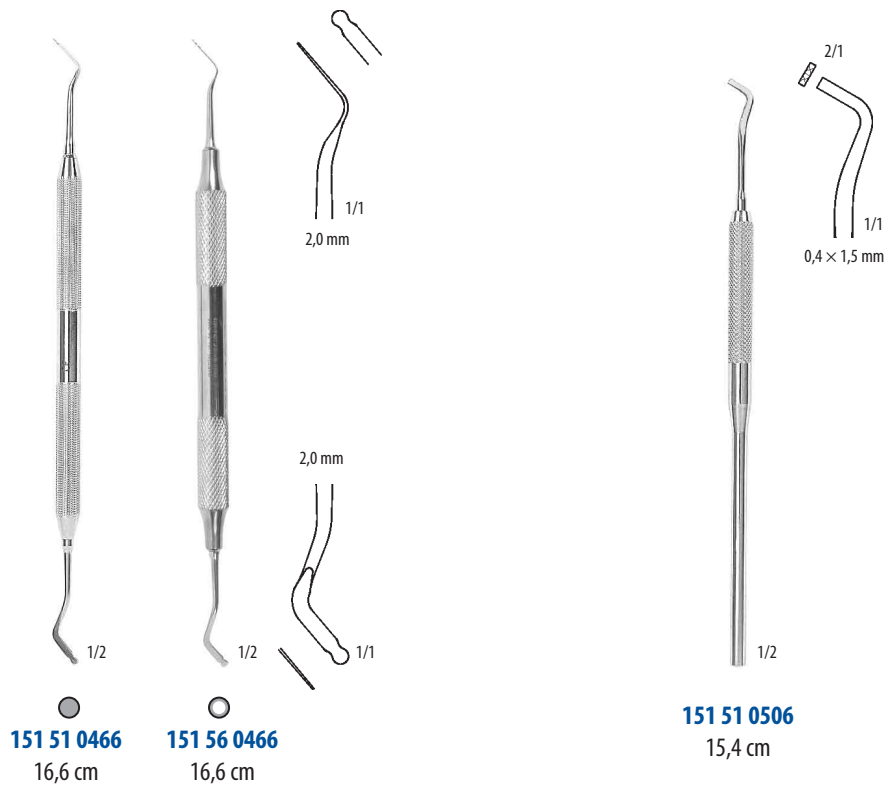

ZAVADĚČE RETRAKČNÍCH VLÁKEN
RETENTIVE FIBRE INSTRUMENTS
RETENTIONS FIBER-INSTRUMENTE

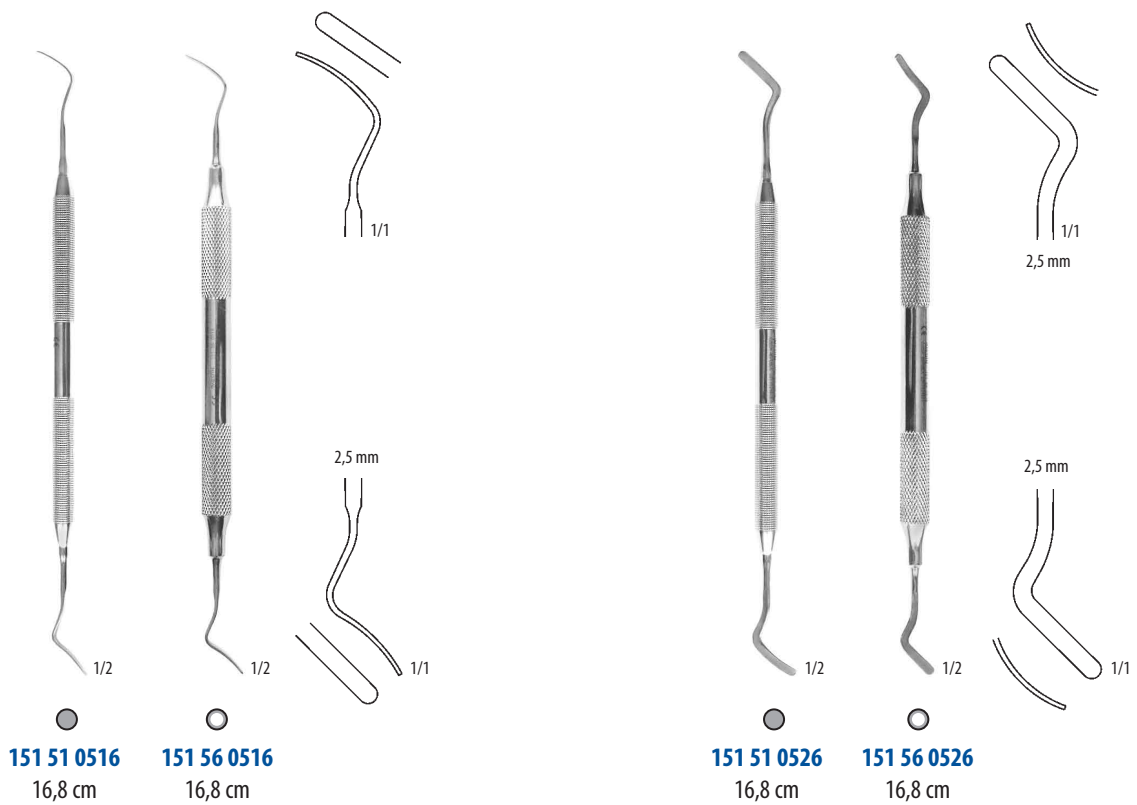

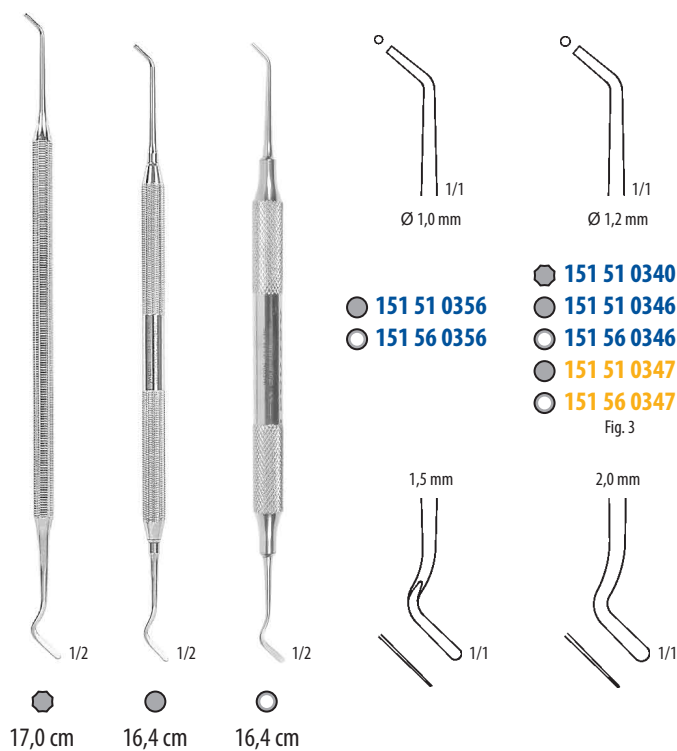
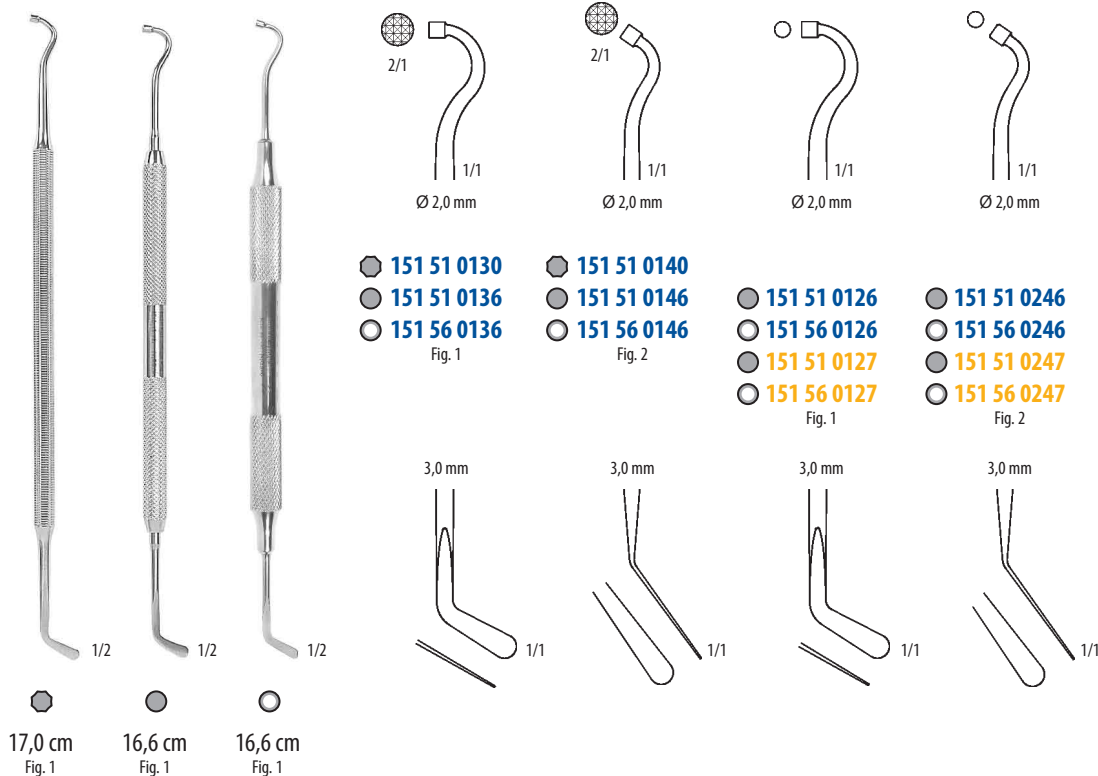
HLADÍTKA SE CPÁTKEM
 SPATULAS – FILLING INSTRUMENTS
 STOPFER-SPATEL, WURZELSTOPFER

●	osmihranné držátko – octagonal handle – Achtkant-Griff	5,5 mm
●	plné držátko – round solid handle – Rundgriff massiv	Ø 6,0 mm
○	duté držátko – hollow handle – Hohlgriff	Ø 8,0 mm

151 5X XXXX	nerez – stainless steel – rostfreier Stahl	
151 5X XXXX	TiN povlak – TiN surface – TiN Beschichtung	

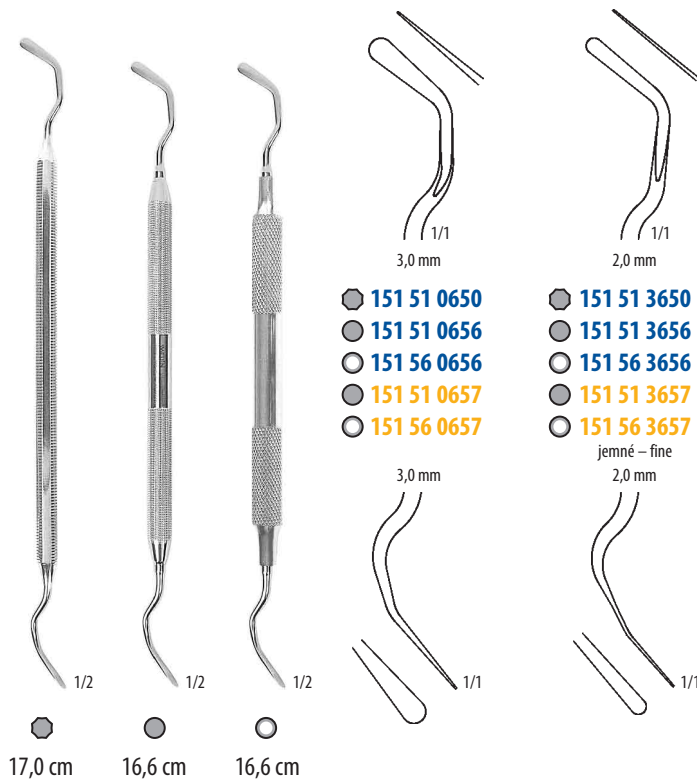
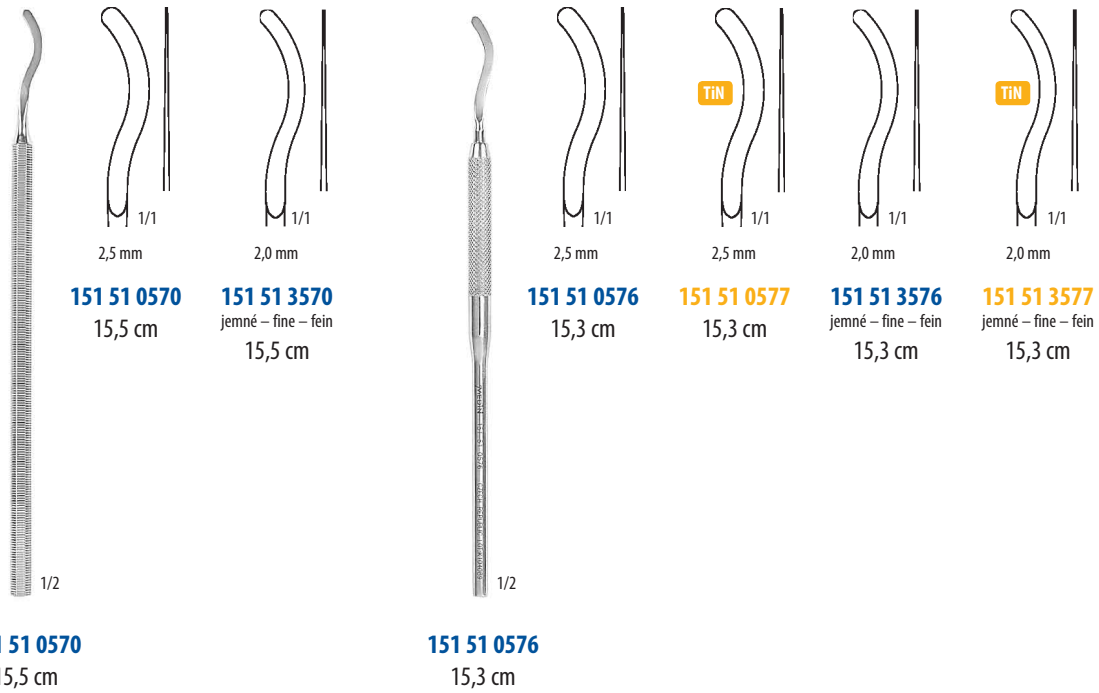

	osmihránné držátko – octagonal handle – Achtkant-Griff	5,5 mm
	plně držátko – round solid handle – Rundgriff massiv	Ø 6,0 mm
	duté držátko – hollow handle – Hohlgriff	Ø 8,0 mm

151 5X XXXX	nerez – stainless steel – rostfreier Stahl	
151 5X XXXX	TiN povlak – TiN surface – TiN Beschichtung	

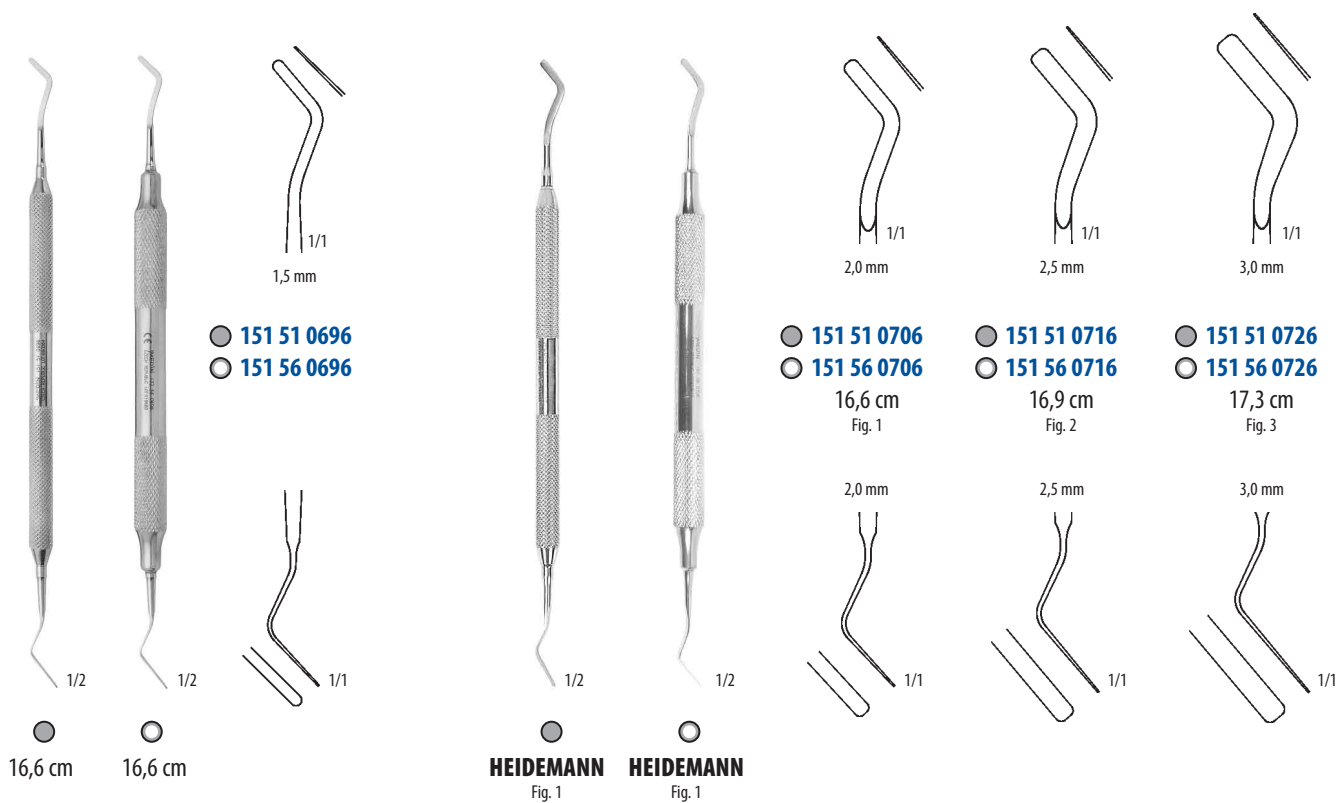
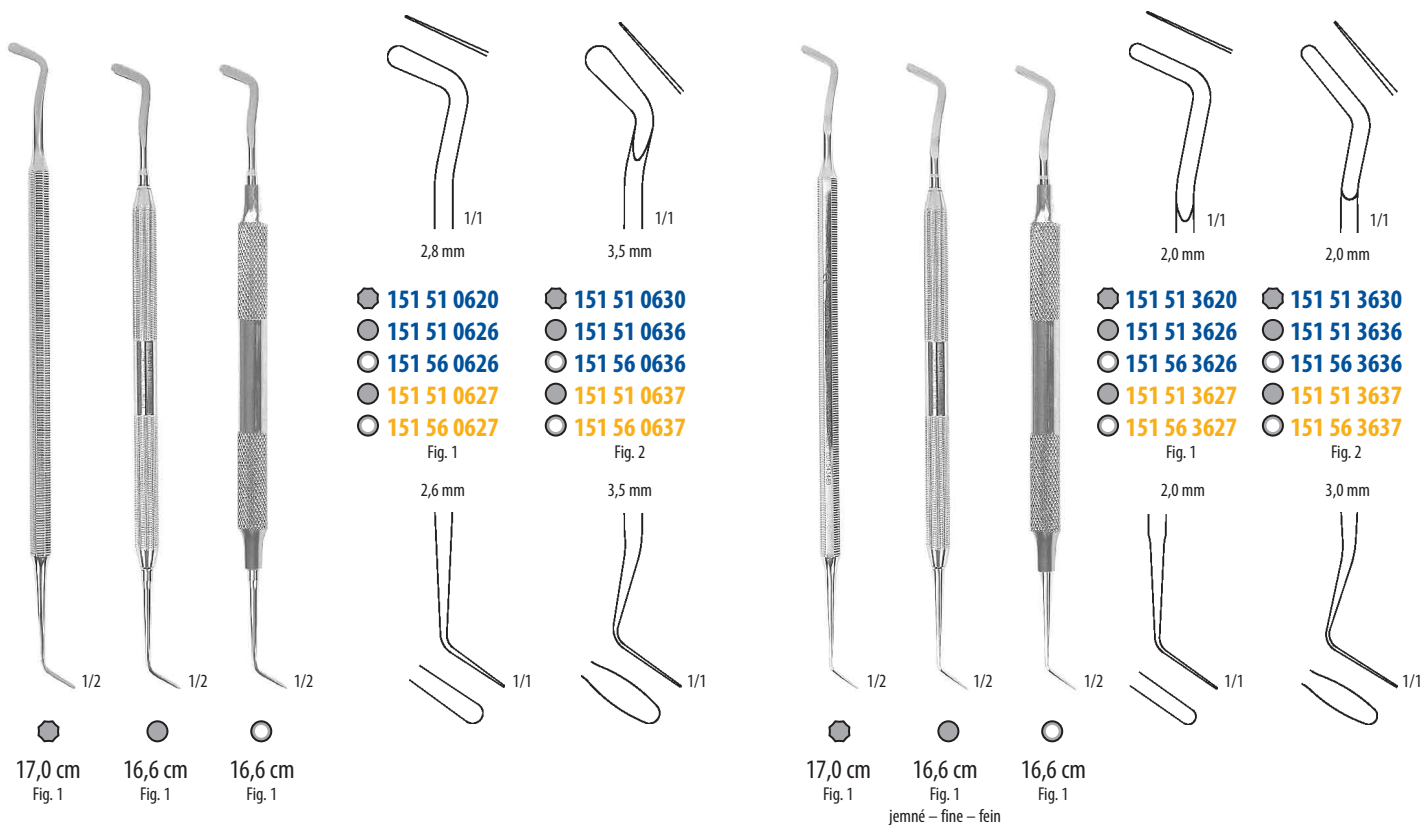

●	osmihřanné držátko – octagonal handle – Achtkant-Griff	5,5 mm
○	plně držátko – round solid handle – Rundgriff massiv	Ø 6,0 mm
○	duté držátko – hollow handle – Hohlgriff	Ø 8,0 mm

151 5X XXXX

nerez – stainless steel – rostfreier Stahl

151 5X XXXX

TiN povlak – TiN surface – TiN Beschichtung

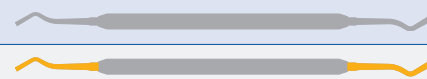

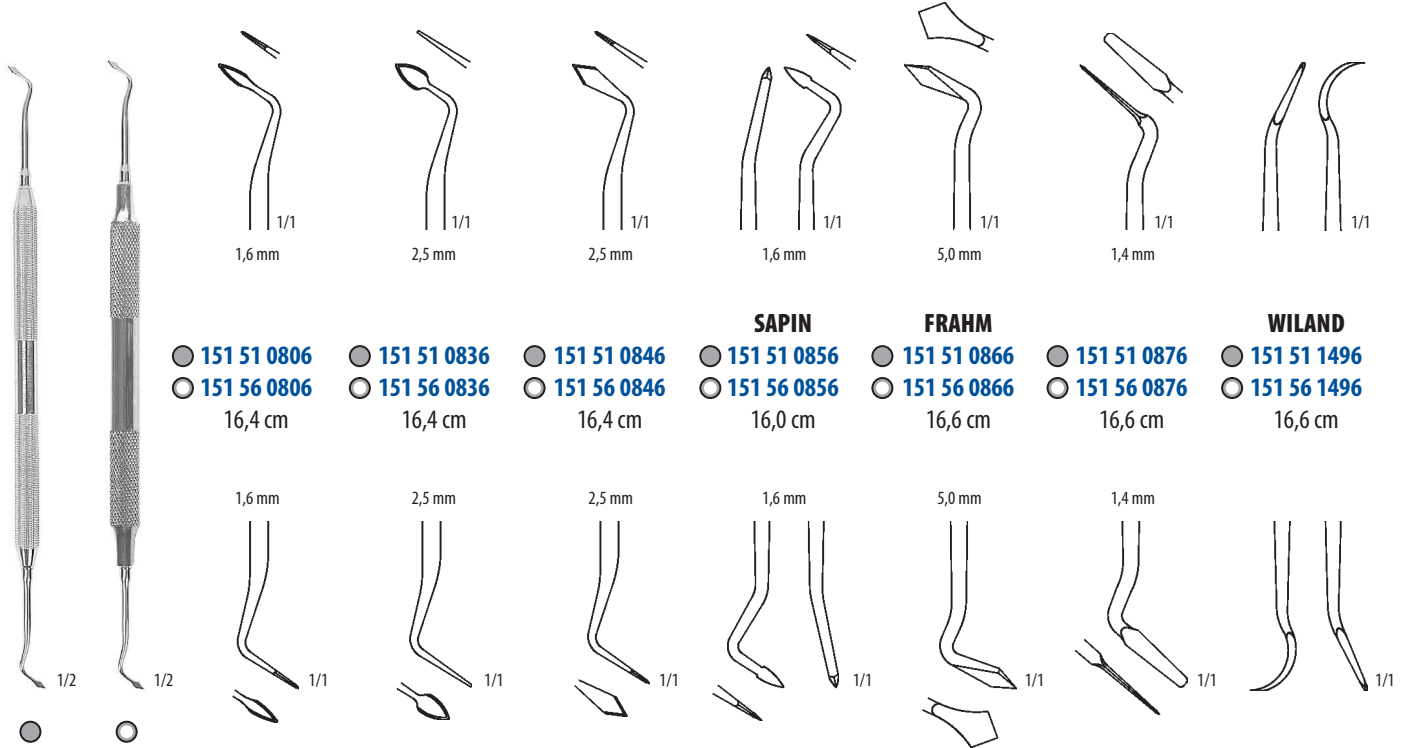

- 151 51 0806
○ 151 56 0806
16,4 cm
- 151 51 0836
○ 151 56 0836
16,4 cm
- 151 51 0846
○ 151 56 0846
16,4 cm
- SAPIN**
● 151 51 0856
○ 151 56 0856
16,0 cm
- FRAHM**
● 151 51 0866
○ 151 56 0866
16,6 cm
- 151 51 0876
○ 151 56 0876
16,6 cm
- WILAND**
● 151 51 1496
○ 151 56 1496
16,6 cm

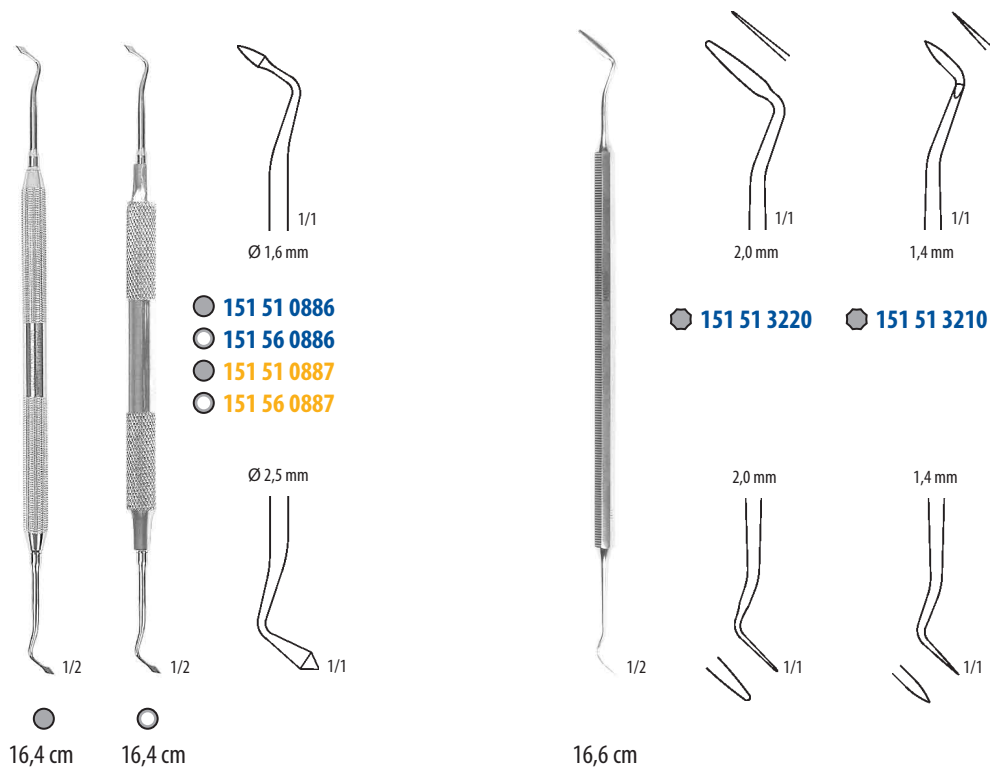

- 151 51 0886
○ 151 56 0886
● 151 51 0887
○ 151 56 0887
- 151 51 3220
- 151 51 3210

●	osmihranné držátko – octagonal handle – Achtkant-Griff	5,5 mm
○	plné držátko – round solid handle – Rundgriff massiv	Ø 6,0 mm
○	duté držátko – hollow handle – Hohlgriff	Ø 8,0 mm

151 5X XXXX	nerez – stainless steel – rostfreier Stahl	
151 5X XXXX	TiN povlak – TiN surface – TiN Beschichtung	

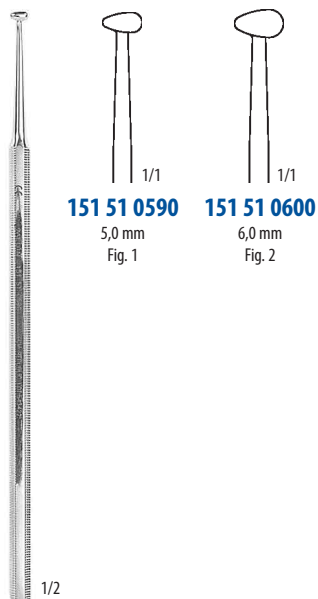

151 51 0590
5,0 mm
Fig. 1

151 51 0600
6,0 mm
Fig. 2

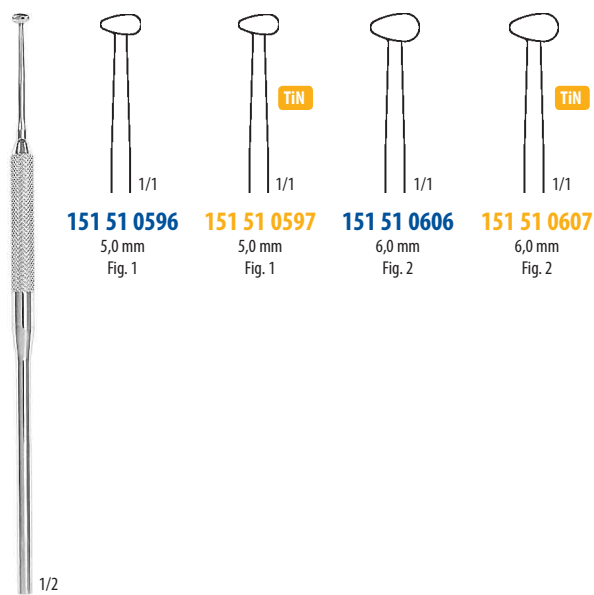

151 51 0596
5,0 mm
Fig. 1

151 51 0597
5,0 mm
Fig. 1

151 51 0606
6,0 mm
Fig. 2

151 51 0607
6,0 mm
Fig. 2

151 51 0590
kapkovitý
guttate profile
15,5 cm

151 51 0596
kapkovitý
guttate profile
15,3 cm

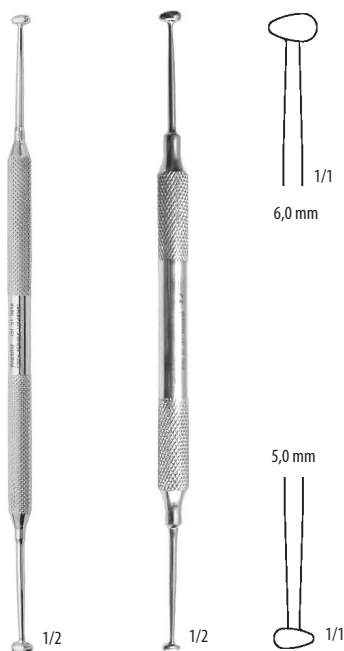

151 51 0616
16,6 cm

151 56 0616
16,6 cm



DISCOID-CLEOID
151 51 0930
16,8 cm

DISCOID-CLEOID
151 51 0936
16,8 cm

DISCOID-CLEOID
151 56 0936
16,8 cm

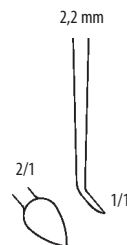
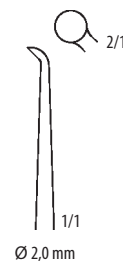

	osmihranné držátko – octagonal handle – Achtkant-Griff	5,5 mm
	plné držátko – round solid handle – Rundgriff massiv	Ø 6,0 mm
	duté držátko – hollow handle – Hohlgriff	Ø 8,0 mm

151 5X XXXX

nerez – stainless steel – rostfreier Stahl

151 5X XXXX

TiN povlak – TiN surface – TiN Beschichtung

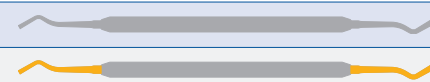



151 51 2020

D35

velmi jemná zrnitost – very fine grain – sehr feine Körnung

120 × 3 mm

151 51 2021

D64

jemná zrnitost – fine grain – feine Körnung

120 × 3 mm

151 51 2022

D107

střední zrnitost – medium grain – mittlere Körnung

120 × 3 mm



151 51 2030

D35

velmi jemná zrnitost – very fine grain – sehr feine Körnung

120 × 4 mm

151 51 2031

D64

jemná zrnitost – fine grain – feine Körnung

120 × 4 mm

151 51 2032

D107

střední zrnitost – medium grain – mittlere Körnung

120 × 4 mm



151 51 2040

D35

velmi jemná zrnitost – very fine grain – sehr feine Körnung

120 × 6 mm

151 51 2041

D64

jemná zrnitost – fine grain – feine Körnung

120 × 6 mm

151 51 2042

D107

střední zrnitost – medium grain – mittlere Körnung

120 × 6 mm



151 51 2050

D35

velmi jemná zrnitost – very fine grain – sehr feine Körnung

120 × 8 mm

151 51 2051

D64

jemná zrnitost – fine grain – feine Körnung

120 × 8 mm

151 51 2052

D107

střední zrnitost – medium grain – mittlere Körnung

120 × 8 mm

SEPARAČNÍ PÁSKY HLADKÉ
SEPARATION STRIPS – SMOOTH
ABTRENNUNGSBÄNDER, GLATT



151 51 1010

120 × 6 mm

151 51 1020

120 × 8 mm

POZNÁMKY: Baleno po 100 ks.
NOTES: Packing of 100 pcs.
ANMERKUNG: Verpackung 100 Stk.

SVORKY NA PÁSKY
STRIP CLAMPS
MATRIZENSPELLER

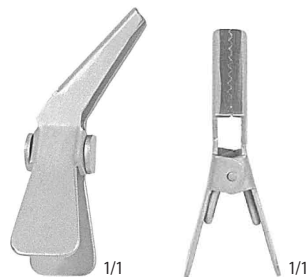

151 51 0970

zahnutá – curved – gebogen
40°

3,3 cm

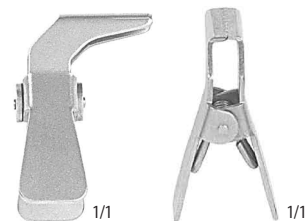

151 51 0980

zahnutá – curved – gebogen
90°

2,5 cm

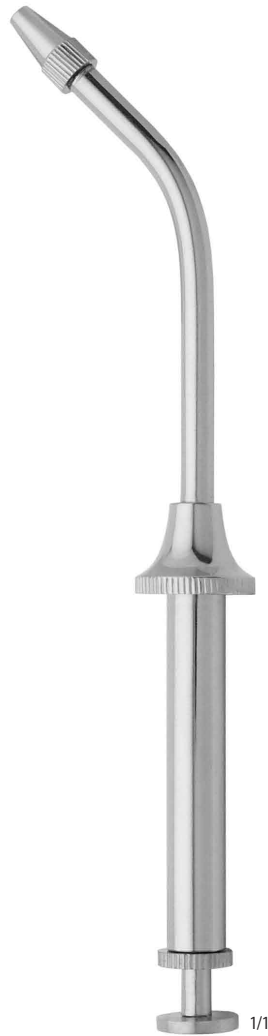

1/1

PISTOLE NA AMALGAM
AMALGAM PISTOL
AMALGAMPISTOLE**151 51 0760**

kovový píst – metal piston – Metal Kolben

14,0 cm



1/2

LOPATKA NA MÍCHÁNÍ
MIXING SPATULA
SPATEL FÜR ABDRUCKMASSEN

121 52 0080

 21,0 cm
27 mm

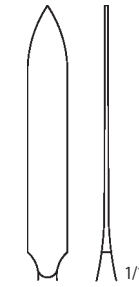

1/2

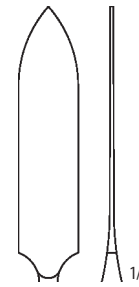
121 52 0010

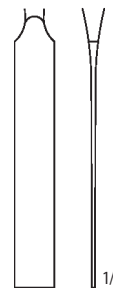
 18,0 cm
5,0 mm

121 52 0020

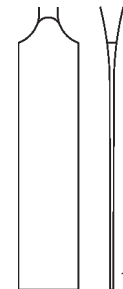
 18,0 cm
7,5 mm

1/1



1/1

LOPATKA NA CEMENT
CEMENT SPATULA
ZEMENTSPATELN

121 52 0020

oboustranná – double faced – doppelendig

18,0 cm



IVORY
156 52 0010
malá – small – klein
2,5 cm



IVORY
156 52 0020
střední – medium – mittel
3,6 cm

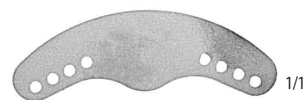

IVORY
156 52 0030
velká – large – gross
3,5 cm

POZNÁMKY: Baleno po 20 ks.

NOTES: Packing of 20 pcs.

ANMERKUNGEN: Verpackung 20 Stk



IVORY
NAPÍNAČ MATRIC
MATRIX RETAINER
MATRIZENSPANNER
156 52 0050
7,0 cm



IVORY
SEPARÁTOR
SEPARATOR
SEPARATOR
156 52 0070
6,7 cm

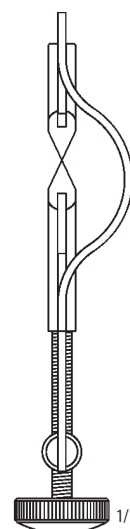



1/1

MATRICE PÁSKOVÁ
MATRIX BAND
MATRIZENBÄNDER

156 91 0001	1 m	5 mm
156 91 0002	1 m	6 mm
156 91 0003	1 m	7 mm

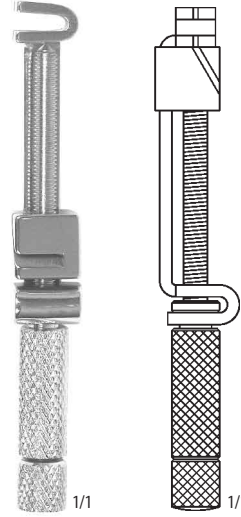

1/1

1/1

NAPÍNAČ MATRIC UNIVERZÁLNÍ
UNIVERSAL RETAINER
MATRIZENSPANNER

156 52 0300
6,4 cm



WAMkey
123 50 0640
14,5 cm



WAMkey
123 50 0650
14,5 cm



WAMkey
123 50 0660
14,5 cm

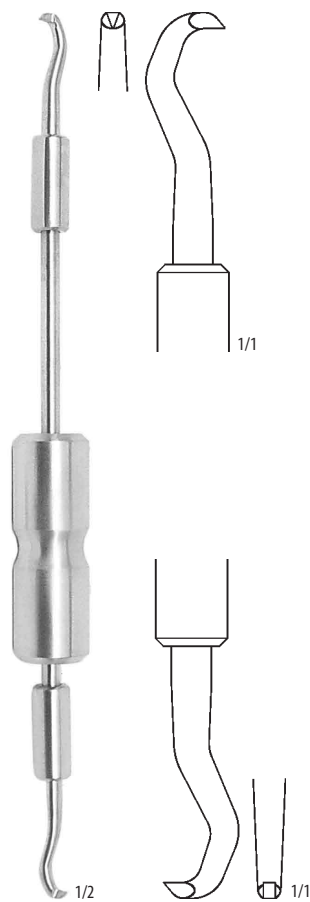

123 50 0610
23,3 cm



SONDY, PÁTRADLA	PROBES	SONDEN	97
KYRETY	CURETTES	KÜRETTEN	98–101
NÁSTROJE NA ZUBNÍ KÁMEN	SCALERS	ZAHNREINIGER	102–107
PILNÍKY	FILES	FEILEN	108

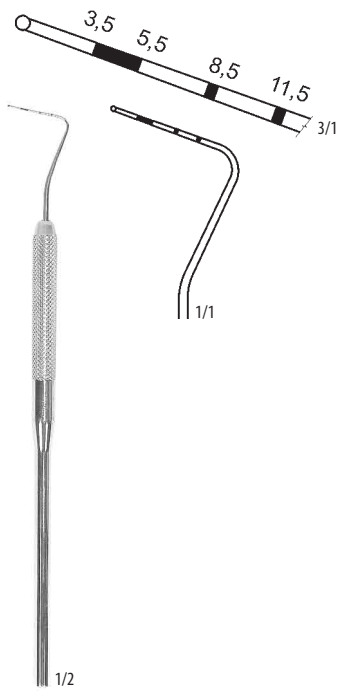

SONDA PARODONTOLOGICKÁ
PERIODONTAL PROBE
PARODONTALSONDE

133 50 0106

15,2 cm
3,5; 5,5; 8,5; 11,5 mm
WHO

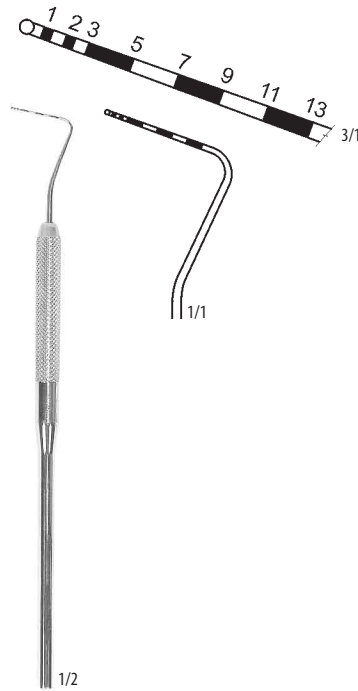

SONDA PARODONTOLOGICKÁ
PERIODONTAL PROBE
PARODONTALSONDE

133 50 0116

15,2 cm
1; 2; 3; 5; 7; 9; 11; 13 mm



EXPLORER
EXPLORER
SONDE MIT HÄKCHEN

133 51 0226

15,5 cm

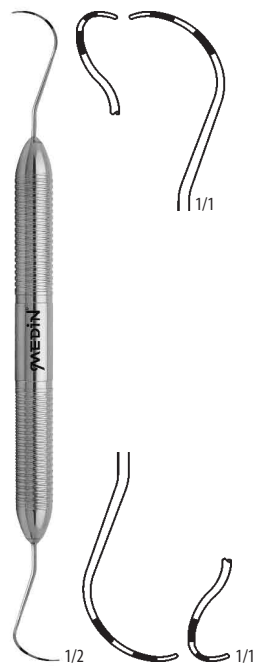

NABERS
FURKAČNÍ SONDA
FURCATION PROBE
FURKATIONSSONDE

133 58 0230

17,2 cm
3-6-9-12

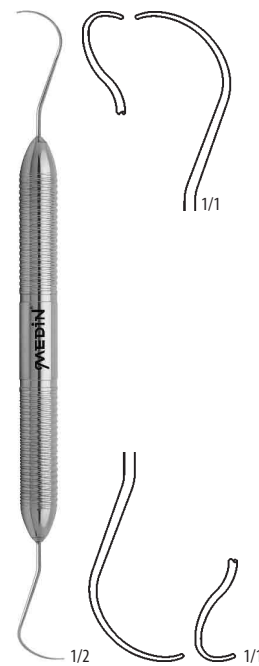

NABERS
FURKAČNÍ SONDA
FURCATION PROBE
FURKATIONSSONDE

133 58 0240

17,2 cm
nekalibrovaná – non calibrated – nicht kalibrierter



GRACEY 1/2
126 58 0056
17,4 cm



GRACEY 3/4
126 58 0066
17,4 cm



GRACEY 5/6
126 58 0076
17,3 cm



GRACEY 7/8
126 58 0086
17,0 cm

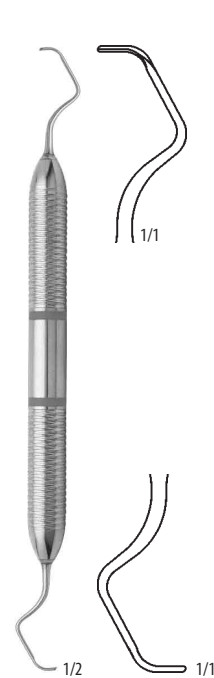

GRACEY 9/10
126 58 0146
16,5 cm



GRACEY 11/12
126 58 0106
17,2 cm

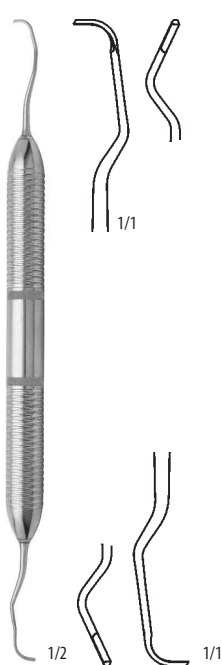

GRACEY 13/14
126 58 0116
17,0 cm



GRACEY 15/16
126 58 0126
17,1 cm

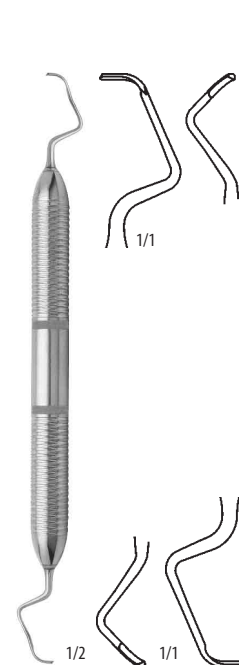

GRACEY 17/18
126 58 0136
15,6 cm



MINI GRACEY 1/2
126 58 1056
17,6 cm



MINI GRACEY 3/4
126 58 1066
17,4 cm



MINI GRACEY 5/6
126 58 1076
17,5 cm



MINI GRACEY 7/8
126 58 1086
17,1 cm



MINI GRACEY 9/10
126 58 1146
16,7 cm



MINI GRACEY 11/12
126 58 1106
17,4 cm



MINI GRACEY 13/14
126 58 1116
17,4 cm



MINI GRACEY 15/16
126 58 1126
17,2 cm

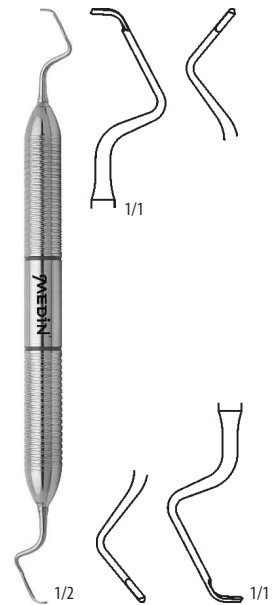

MINI GRACEY 17/18
126 58 1136
15,8 cm

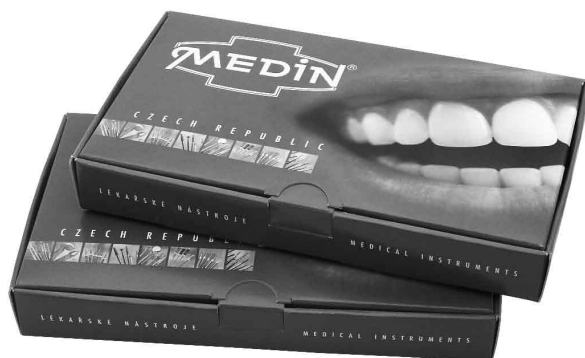
 SOUBOR PARODONTOLOGICKÝCH NÁSTROJŮ, SET 1
 SET OF PERIODONTAL INSTRUMENTS, SET 1
 SATZ DER PARODONTOLOGIE-INSRUMENTEN 1

139 50 0770

				počet ks – number of pcs – Anzahl
126 58 0056	GRACEY KYRETA 1/2; 17,4 cm	GRACEY CURETTE 1/2; 17,4 cm	GRACEY KÜRETTE 1/2; 17,4 cm	1
126 58 0066	GRACEY KYRETA 3/4; 17,4 cm	GRACEY CURETTE 3/4; 17,4 cm	GRACEY KÜRETTE 3/4; 17,4 cm	1
126 58 0076	GRACEY KYRETA 5/6; 17,3 cm	GRACEY CURETTE 5/6; 17,3 cm	GRACEY KÜRETTE 5/6; 17,3 cm	1
126 58 0086	GRACEY KYRETA 7/8; 17,0 cm	GRACEY CURETTE 7/8; 17,0 cm	GRACEY KÜRETTE 7/8; 17,0 cm	1
126 58 0096	SCALER OBOUSTRANNÝ; 16,7 cm	SCALER DOUBLE-FACED; 16,7 cm	ZAHNREINIGER DOPPELSEITIG; 16,7 cm	1
126 58 0106	GRACEY KYRETA 11/12; 17,2 cm	GRACEY CURETTE 11/12; 17,2 cm	GRACEY KÜRETTE 11/12; 17,2 cm	1
126 58 0116	GRACEY KYRETA 13/14; 17,0 cm	GRACEY CURETTE 13/14; 17,0 cm	GRACEY KÜRETTE 13/14; 17,0 cm	1
126 58 0126	GRACEY KYRETA 15/16; 17,1 cm	GRACEY CURETTE 15/16; 17,1 cm	GRACEY KÜRETTE 15/16; 17,1 cm	1
126 58 0136	GRACEY KYRETA 17/18; 15,6 cm	GRACEY CURETTE 17/18; 15,6 cm	GRACEY KÜRETTE 17/18; 15,6 cm	1
126 58 0146	GRACEY KYRETA 9/10; 16,5 cm	GRACEY CURETTE 9/10; 16,5 cm	GRACEY KÜRETTE 9/10; 16,5 cm	1

 SOUBOR PARODONTOLOGICKÝCH NÁSTROJŮ, SET 2
 SET OF PERIODONTAL INSTRUMENTS, SET 2
 SATZ DER PARODONTOLOGIE-INSRUMENTEN 2

139 50 0780

				počet ks – number of pcs – Anzahl
126 58 0076	GRACEY KYRETA 5/6; 17,3 cm	GRACEY CURETTE 5/6; 17,3 cm	GRACEY KÜRETTE 5/6; 17,3 cm	1
126 58 0086	GRACEY KYRETA 7/8; 17,0 cm	GRACEY CURETTE 7/8; 17,0 cm	GRACEY KÜRETTE 7/8; 17,0 cm	1
126 58 0096	SCALER OBOUSTRANNÝ; 16,7 cm	SCALER DOUBLE-FACED; 16,7 cm	ZAHNREINIGER DOPPELSEITIG; 16,7 cm	1
126 58 0106	GRACEY KYRETA 11/12; 17,2 cm	GRACEY CURETTE 11/12; 17,2 cm	GRACEY KÜRETTE 11/12; 17,2 cm	1
126 58 0116	GRACEY KYRETA 13/14; 17,0 cm	GRACEY CURETTE 13/14; 17,0 cm	GRACEY KÜRETTE 13/14; 17,0 cm	1

 SOUBOR PARODONTOLOGICKÝCH NÁSTROJŮ MINI, SET 1
 SET OF MINI PERIODONTAL INSTRUMENTS, SET 1
 SATZ DER MINI PARODONTOLOGIE-INSRUMENTEN 1

139 50 0810

				počet ks – number of pcs – Anzahl
126 58 1056	MINI GRACEY KYRETA 1/2; 17,6 cm	MINI GRACEY CURETTE 1/2; 17,6 cm	MINI GRACEY KÜRETTE 1/2; 17,6 cm	1
126 58 1066	MINI GRACEY KYRETA 3/4; 17,4 cm	MINI GRACEY CURETTE 3/4; 17,4 cm	MINI GRACEY KÜRETTE 3/4; 17,4 cm	1
126 58 1076	MINI GRACEY KYRETA 5/6; 17,5 cm	MINI GRACEY CURETTE 5/6; 17,5 cm	MINI GRACEY KÜRETTE 5/6; 17,5 cm	1
126 58 1086	MINI GRACEY KYRETA 7/8; 17,1 cm	MINI GRACEY CURETTE 7/8; 17,1 cm	MINI GRACEY KÜRETTE 7/8; 17,1 cm	1
126 58 0096	SCALER OBOUSTRANNÝ; 16,7 cm	SCALER DOUBLE-FACED; 16,7 cm	ZAHNREINIGER DOPPELSEITIG; 16,7 cm	1
126 58 1106	MINI GRACEY KYRETA 11/12; 17,4 cm	MINI GRACEY CURETTE 11/12; 17,4 cm	MINI GRACEY KÜRETTE 11/12; 17,4 cm	1
126 58 1116	MINI GRACEY KYRETA 13/14; 17,4 cm	MINI GRACEY CURETTE 13/14; 17,4 cm	MINI GRACEY KÜRETTE 13/14; 17,4 cm	1
126 58 1126	MINI GRACEY KYRETA 15/16; 17,2 cm	MINI GRACEY CURETTE 15/16; 17,2 cm	MINI GRACEY KÜRETTE 15/16; 17,2 cm	1
126 58 1136	MINI GRACEY KYRETA 17/18; 15,8 cm	MINI GRACEY CURETTE 17/18; 15,8 cm	MINI GRACEY KÜRETTE 17/18; 15,8 cm	1
126 58 1146	MINI GRACEY KYRETA 9/10; 16,7 cm	MINI GRACEY CURETTE 9/10; 16,7 cm	MINI GRACEY KÜRETTE 9/10; 16,7 cm	1



FURKAČNÍ KYRETA
FURCATION CURETTE
FURKATIONS-KÜRETTE

124 58 0010

17,2 cm

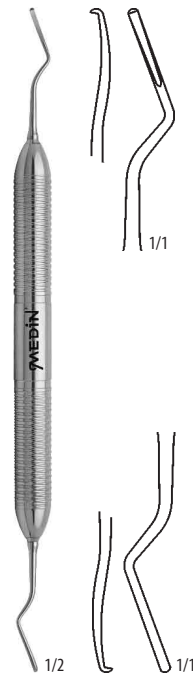

FURKAČNÍ KYRETA
FURCATION CURETTE
FURKATIONS-KÜRETTE

124 58 0020

17,6 cm



SCALER
SCALER
ZAHNREINIGER

126 58 0096

oboustranný – double faced – doppelseitig

16,7 cm

PŘÍSLUŠENSTVÍ PRO PARODONTOLOGII
PERIODONTAL ACCESSORIES
PARO-ZUBEHÖR



BROUSEK NA OSTŘENÍ KYRET
SHARPENING STONE FOR CURETTES
SCHLEIFSTEIN ZUM NACHSCHÄRFEN

126 91 0162



TESTOVACÍ TYČINKA PMMA
PLASTIC TEST STICK
TESTSTÄBCHEN AUS KUNSTSTOFF

126 53 0010

80 mm



147 51 0010
15,5 cm

147 51 0018
15,5 cm

147 51 0016
15,5 cm

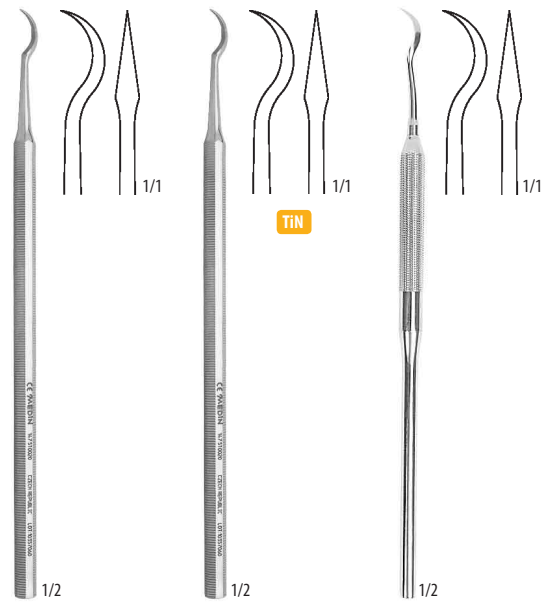

147 51 0020
15,5 cm

147 51 0028
15,5 cm

147 51 0026
15,5 cm

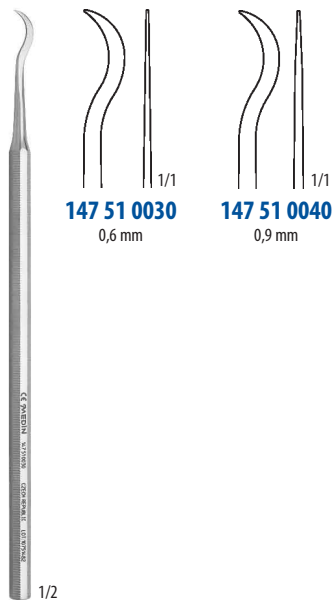

147 51 0030
15,5 cm

147 51 0030
0,6 mm

147 51 0040
0,9 mm

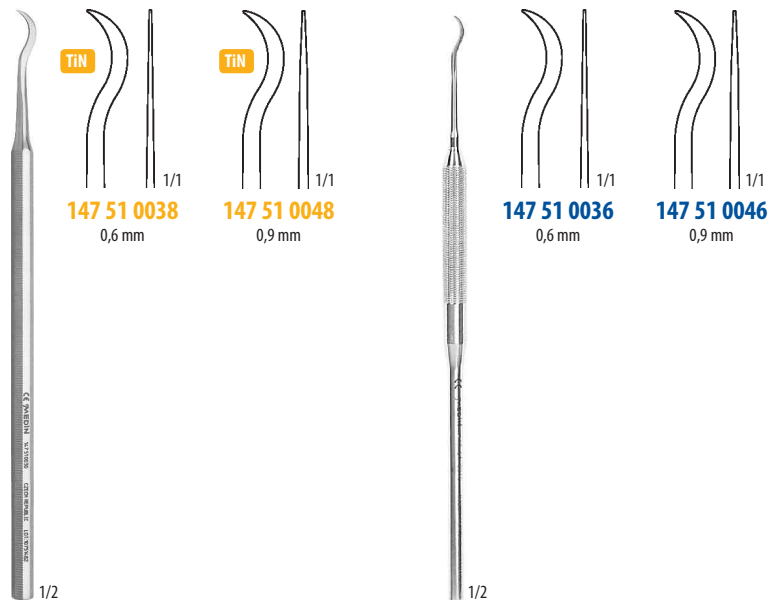

147 51 0038
15,5 cm

147 51 0038
0,6 mm

147 51 0048
0,9 mm

147 51 0036
0,6 mm

147 51 0046
0,9 mm

147 51 0036
15,5 cm



147 51 0060
2× lomený
double angled
2× gebogen
15,5 cm

147 51 0068
2× lomený
double angled
2× gebogen
15,5 cm

147 51 0066
2× lomený
double angled
2× gebogen
15,5 cm

ŠKRABKY NA ZUBNÍ KÁMEN
SCALERS
ZAHNREINIGER

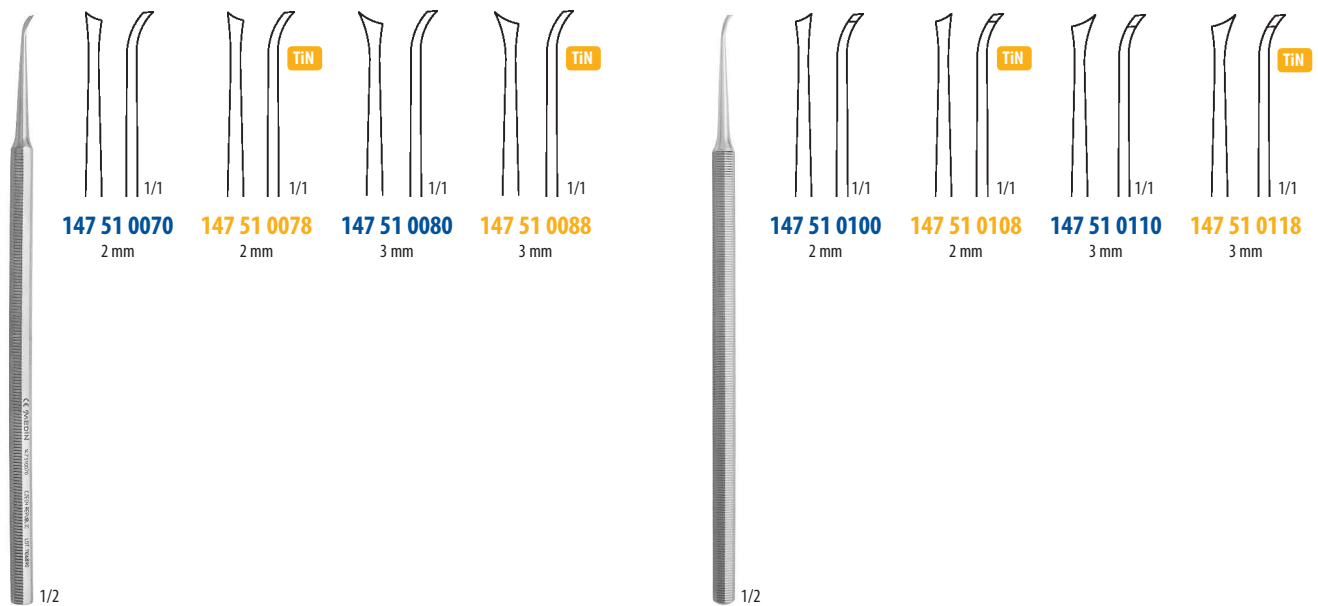

147 51 0070
pravá – right – rechts
15,5 cm

147 51 0100
levá – left – links
15,5 cm

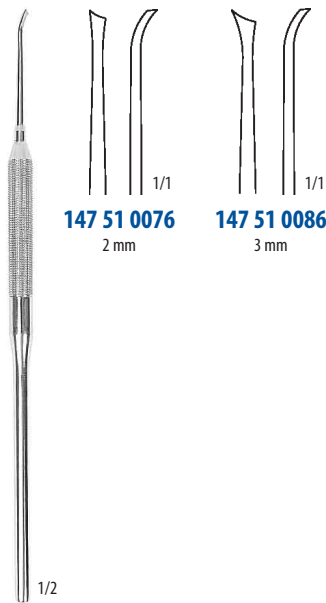
ŠKRABKY NA ZUBNÍ KÁMEN
SCALERS
ZAHNREINIGER

147 51 0076
pravá – right – rechts
15,5 cm

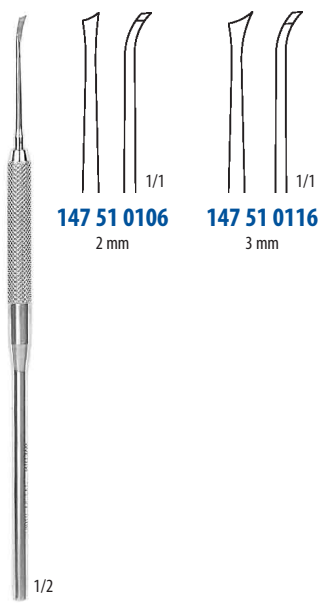

147 51 0106
levá – left – links
15,5 cm

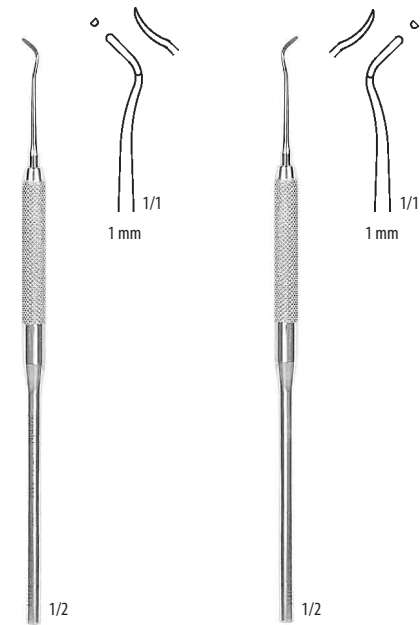

BLACK
147 51 0336
levá – left – links
15,5 cm

BLACK
147 51 0346
pravá – right – rechts
15,5 cm

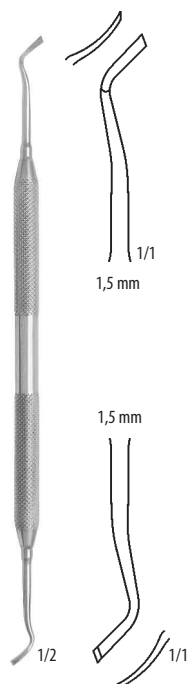
ZEŠIKMOVAČE GINGIVÁLNÍCH OKRAJŮ
GINGIVAL MARGIN TRIMMERS
GINGIVALRANDSCHRÄGER

147 51 0806
distální – distal
16,6 cm

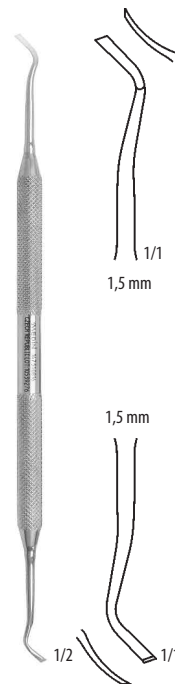

147 51 0816
meziální – mesial
16,5 cm

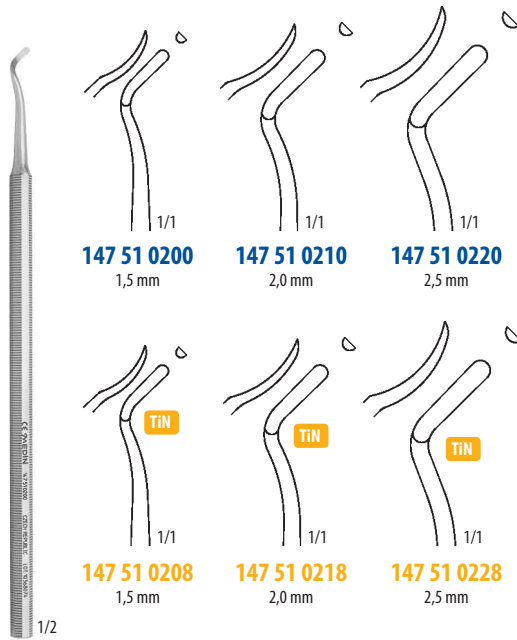

147 51 0200
pravý – right – rechts
15,5 cm

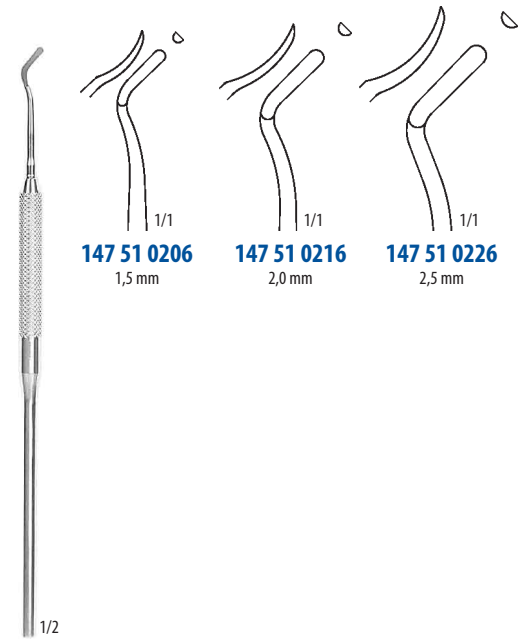

147 51 0206
pravý – right – rechts
15,5 cm

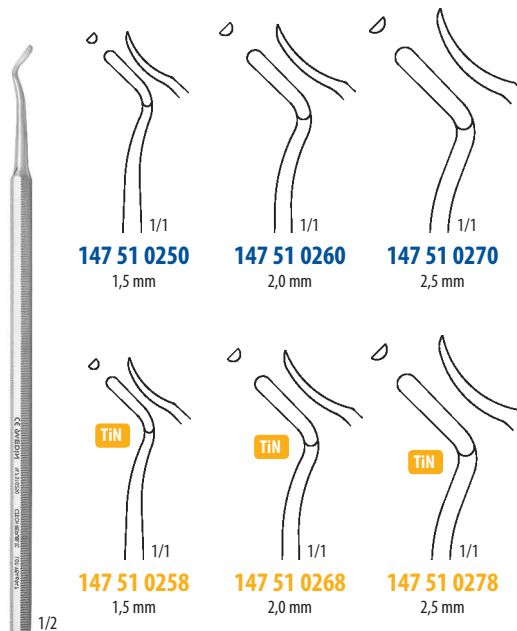

147 51 0250
levý – left – links
15,5 cm

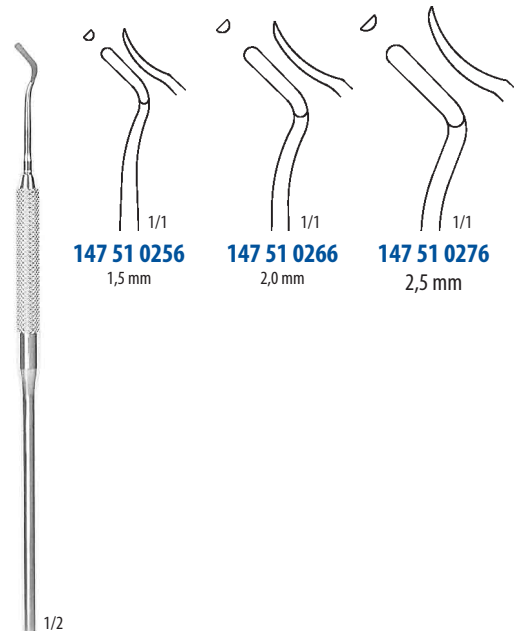

147 51 0256
levý – left – links
15,5 cm

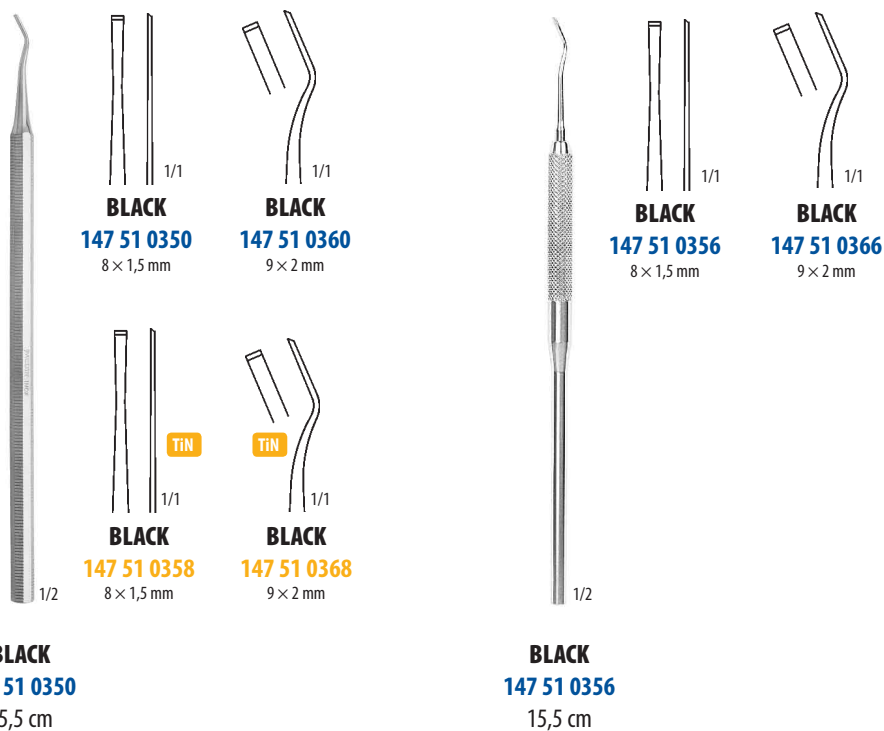
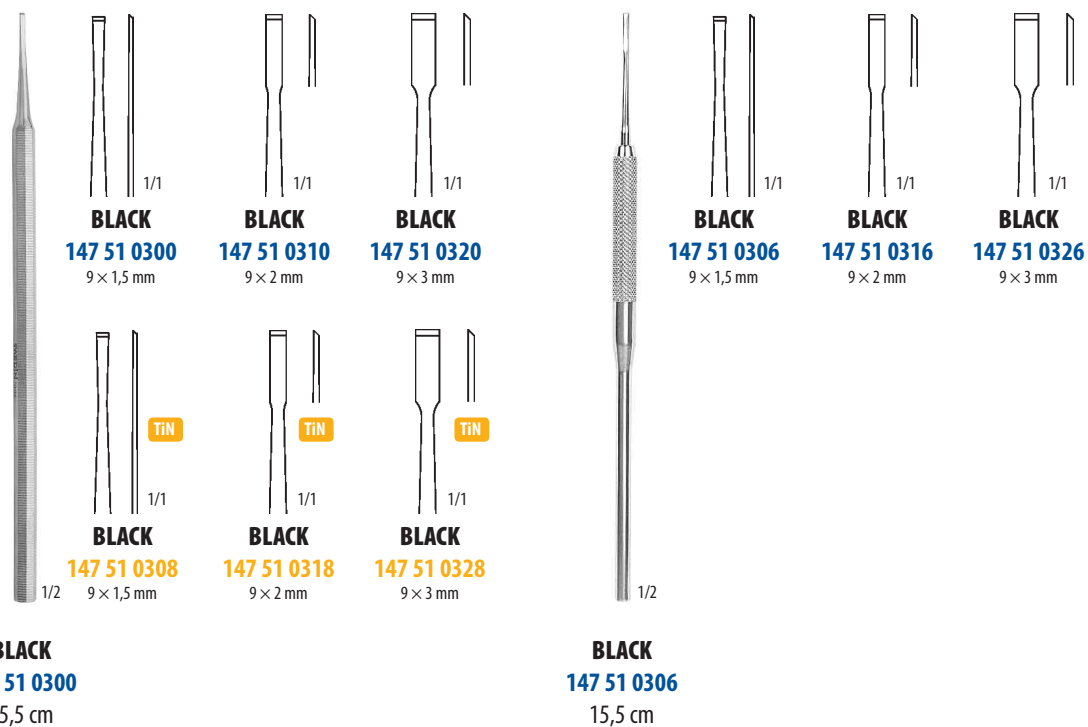

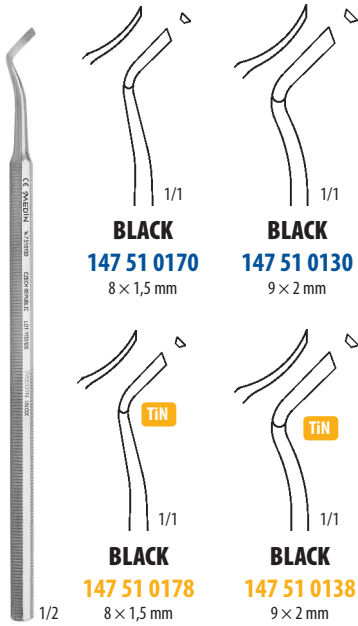

BLACK
147 51 0130
pravá – right – rechts
15,5 cm

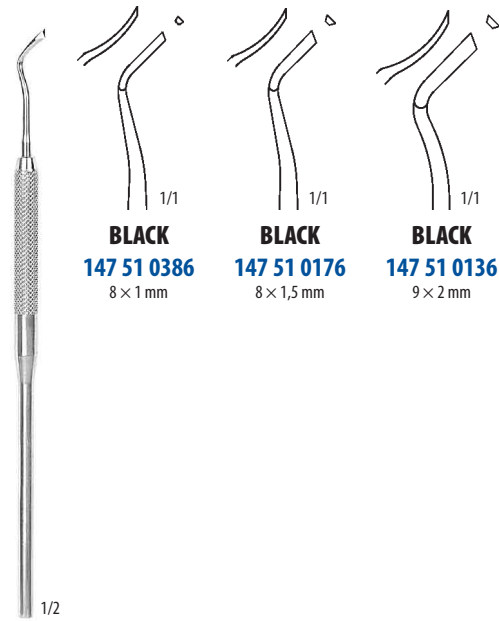

BLACK
147 51 0136
pravá – right – rechts
15,5 cm

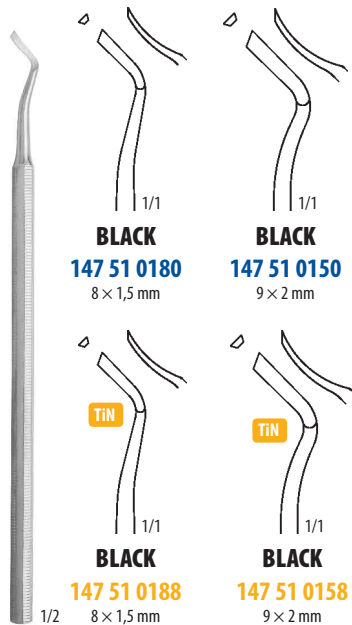

BLACK
147 51 0150
levá – left – links
15,5 cm

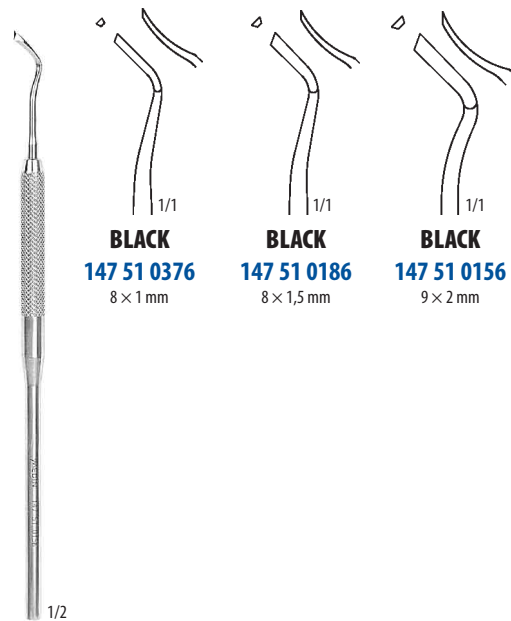

BLACK
147 51 0156
levá – left – links
15,5 cm



127 51 1206
15,0 cm

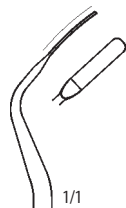

127 51 1206
15,0 cm
2 × 8 mm
Fig. 1



127 51 1216
15,0 cm
2 × 8 mm
Fig. 2



127 51 1226
15,2 cm
2 × 8 mm
Fig. 3



127 51 1236
15,2 cm
2 × 8 mm
Fig. 4



127 51 1306
jehlový – needle – nadelförmig
15,0 cm



127 51 1316
15,0 cm



127 51 1316
15,0 cm
2 × 8 mm
Fig. 5



127 51 1326
15,0 cm
2 × 8 mm
Fig. 6

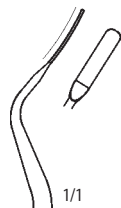

127 51 1336
15,0 cm
2 × 8 mm
Fig. 7



127 51 1346
15,0 cm
2 × 8 mm
Fig. 8



ORTODONTICKÉ ŠROUBY	EXPANDING SCREWS	DEHNSCHRAUBEN	111–112
KLEŠTĚ ÚCHOPNÉ	GRASPING FORCEPS	HALTERZANGEN	113
KLEŠTĚ ŠTÍPACÍ	CUTTING RONGEURS	HOHLMEISSELZANGEN	113
KLEŠTĚ ÚCHOPNÉ	GRASPING FORCEPS	HALTERZANGEN	114–116



1/1

152 52 0810

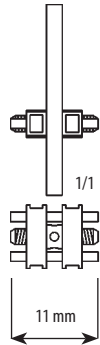
 expanze – expansion – Ausdehnung
 3,5 mm
 Fig. 1

1/1

11 mm

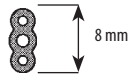

8 mm



1/1

152 52 0820

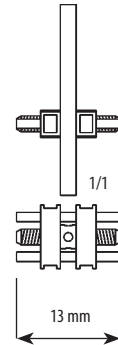
 expanze – expansion – Ausdehnung
 5,5 mm
 Fig. 2

1/1

13 mm

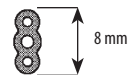

8 mm

 ORTODONTICKÉ ŠROUBY – JEDNOSTRANNÉ
 EXPANDING SCREWS – SINGLE FACED
 DEHNSCHRAUBEN EINSEITIG

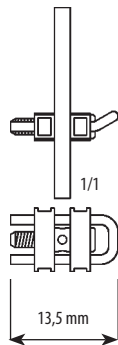

1/1

152 52 0950

 expanze – expansion – Ausdehnung
 3 mm
 Fig. 1

1/1

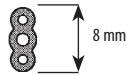
13,5 mm



8 mm



1/1

152 52 0990

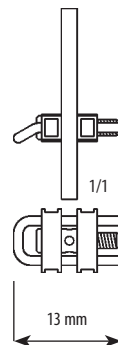
 expanze – expansion – Ausdehnung
 3 mm
 Fig. 5

1/1

13 mm



8 mm



1/1

152 52 0970

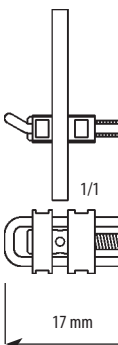
 expanze – expansion – Ausdehnung
 5,5 mm
 Fig. 3

1/1

17 mm

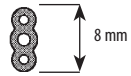

8 mm



1/1

152 52 1000

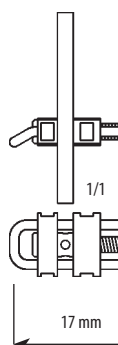
 expanze – expansion – Ausdehnung
 5,5 mm
 Fig. 6

1/1

17 mm



8 mm



1/1

152 52 0960

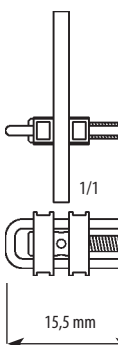
 expanze – expansion – Ausdehnung
 5 mm
 Fig. 2

1/1

15,5 mm



8 mm



1/1

152 52 0980

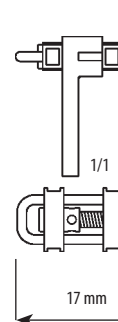
 kontrakce – contraction – Kontraktion
 3 mm
 Fig. 4

1/1

17 mm

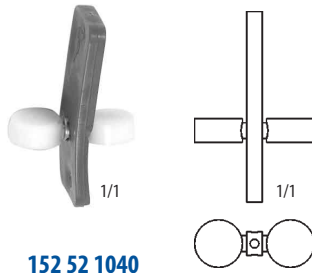

8 mm

ORTODONTICKÉ ŠROUBY K VĚJÍŘOVÉ EXANZI
 EXPANDING SCREWS FOR FAN EXPANSION
 VECHERDEHNSCHRAUBEN

152 52 1040
expanze – expansion
7 mm



152 52 1020
kloub – join

POZNÁMKY: Baleno po 10 ks.
 NOTES: Packing of 10 pcs.
 ANMERKUNG: Verpackung 10 Stk.

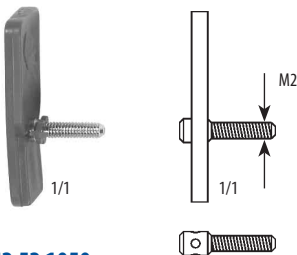
 ORTODONTICKÉ ŠROUBY – BODOVÉ
 EXPANDING SCREWS – POINT
 PUNKTDEHNSCHRAUBEN

152 52 1050
expanze – expansion
5 mm

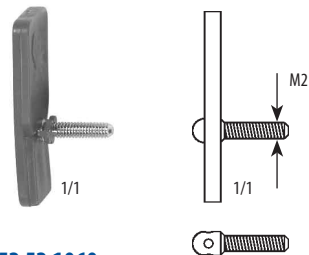

152 52 1060
expanze – expansion
5 mm

POZNÁMKY: Baleno po 10 ks.
 NOTES: Packing of 10 pcs.
 ANMERKUNG: Verpackung 10 Stk.

 KLÍČEK ORTODONTICKÝ
 ORTHODONTIC SPANNER
 DEHNSCHRAUBE SCHLÜSELL

943 61 0005
36,5 mm

POZNÁMKY: Klíček 943 61 0005 – na zvláštní objednávku. Baleno po 10 ks.
 NOTES: Insert 943 61 0005 – for special order. Packing of 10 pcs.
 ANMERKUNG: Dehnschraube Schlüssel 943 61 0005 – Sonderbestellung. Verpackung 10 Stk.



KLEŠTĚ NA KELÍMKY
CRUCIBLE FORCEPS
MUFFELZANGEN
117 52 0770
50,0 cm

1/3



KLEŠTĚ NA KELÍMKY
CRUCIBLE FORCEPS
MUFFELZANGEN
117 52 0780
27,5 cm

1/3

KLEŠTĚ ŠTÍPACÍ NA DRÁT
WIRE CUTTING FORCEPS
DRAHTKNEIFZANGE



1/2

116 91 0001
14,5 cm
pro měkký drát do průměru 1,5 mm
for soft wires up to diameter 1,5 mm
für weichen Draht bis Durchmesser 1,5 mm

pro tvrdý drát do průměru 1,0 mm
for hard wires up to diameter 1,0 mm
für harten Draht bis Durchmesser 1,0 mm



univerzální kramponové
universal bending pliers
Kramponzange universal

117 52 0700

13,5 cm

pro tvrdý drát do průměru 0,8 mm
for hard wires up to diameter 0,8 mm
für harten Draht bis Durchmesser 0,8 mm

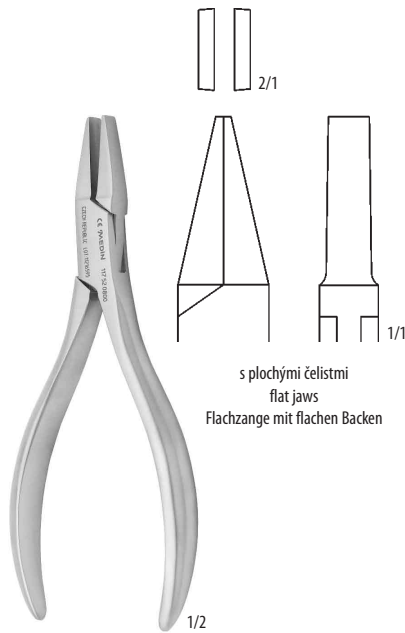

s plochými čelistmi
flat jaws
Flachzange mit flachen Backen

117 52 0800

13,4 cm

pro tvrdý drát do průměru 1,2 mm
for hard wires up to diameter 1,2 mm
für harten Draht bis Durchmesser 1,2 mm

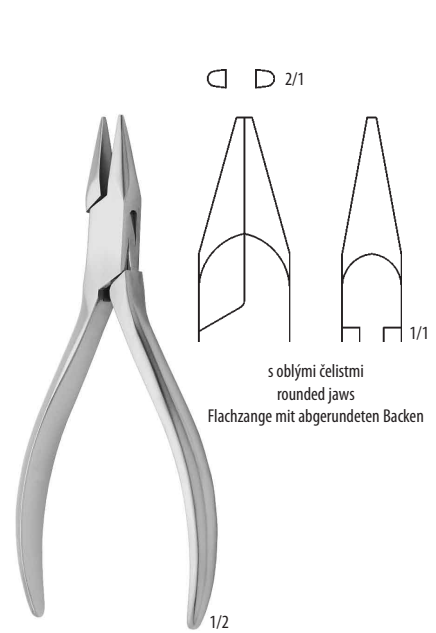

s obléými čelistmi
rounded jaws
Flachzange mit abgerundeten Backen

117 52 0810

13,4 cm

pro tvrdý drát do průměru 1,1 mm
for hard wires up to diameter 1,1 mm
für harten Draht bis Durchmesser 1,1 mm

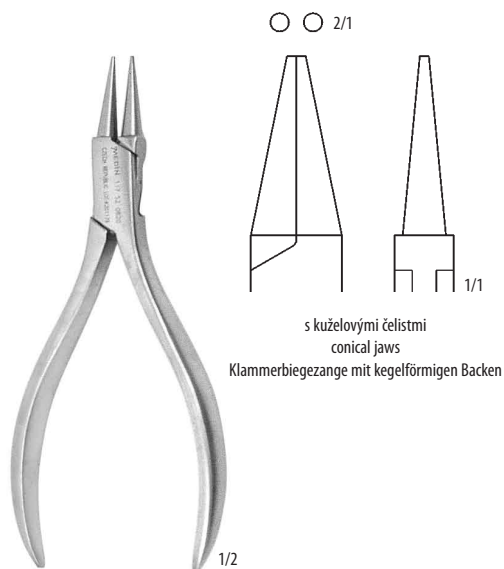

s kuželovými čelistmi
conical jaws
Klammerbiegezange mit kegelförmigen Backen

117 52 0820

13,4 cm

pro tvrdý drát do průměru 1,2 mm
for hard wires up to diameter 1,2 mm
für harten Draht bis Durchmesser 1,2 mm

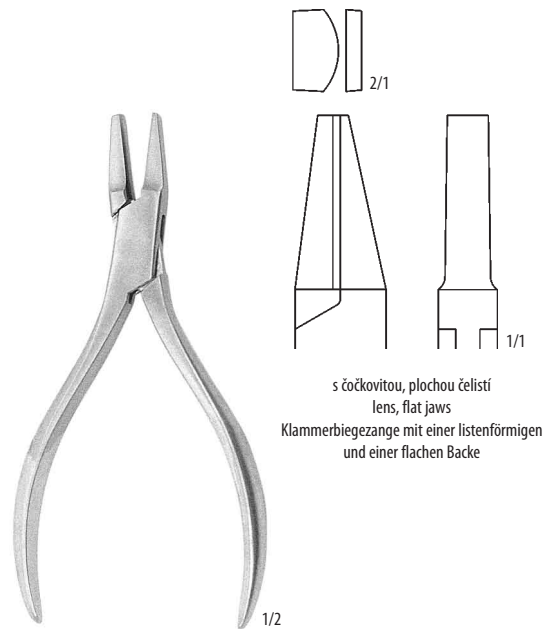

s čočkovitou, plochou čelistí
lens, flat jaws
Klammerbiegezange mit einer listenförmigen
und einer flachen Backe

117 52 0830

13,4 cm

pro tvrdý drát do průměru 1,4 mm
for hard wires up to diameter 1,4 mm
für harten Draht bis Durchmesser 1,4 mm

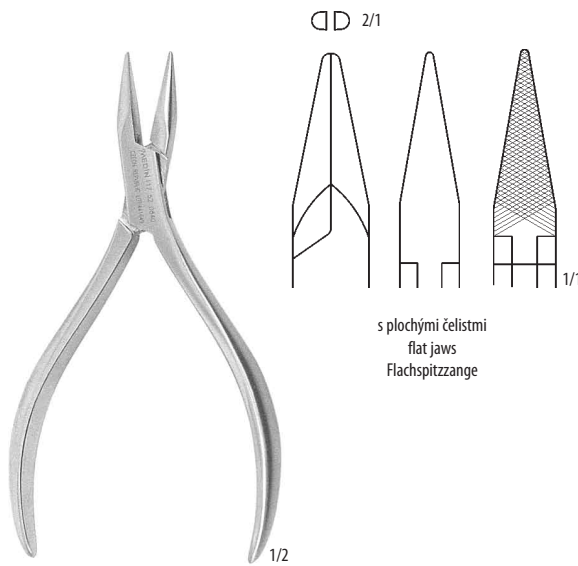

117 52 0840
13,5 cm
pro tvrdý drát do průměru 1,2 mm
for hard wires up to diameter 1,2 mm
für harten Draht bis Durchmesser 1,2 mm
Fig. 1

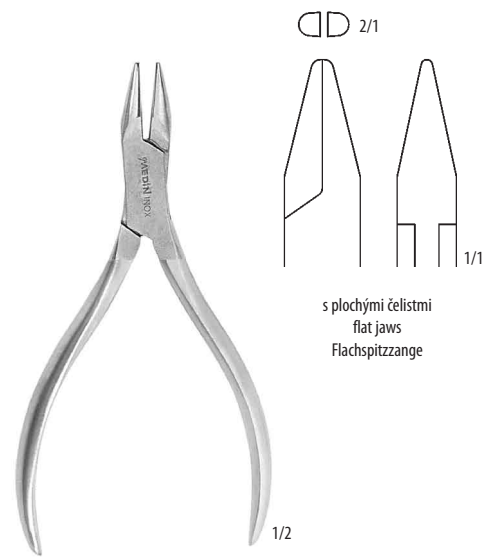

117 52 0870
13,0 cm
pro tvrdý drát do průměru 1,2 mm
for hard wires up to diameter 1,2 mm
für harten Draht bis Durchmesser 1,2 mm
Fig. 4

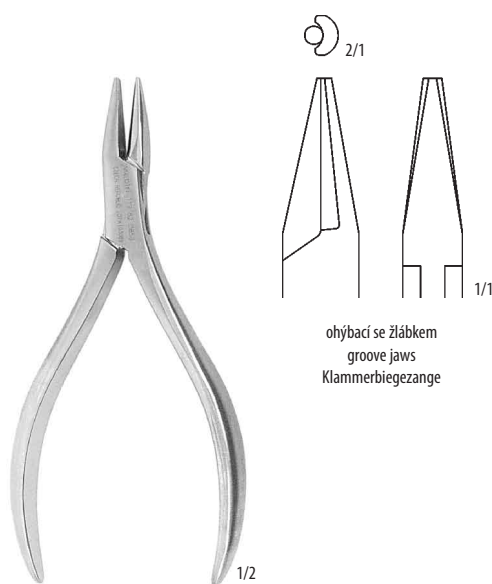

117 52 0850
13,3 cm
pro tvrdý drát do průměru 0,8 mm
for hard wires up to diameter 0,8 mm
für harten Draht bis Durchmesser 0,8 mm
Fig. 2

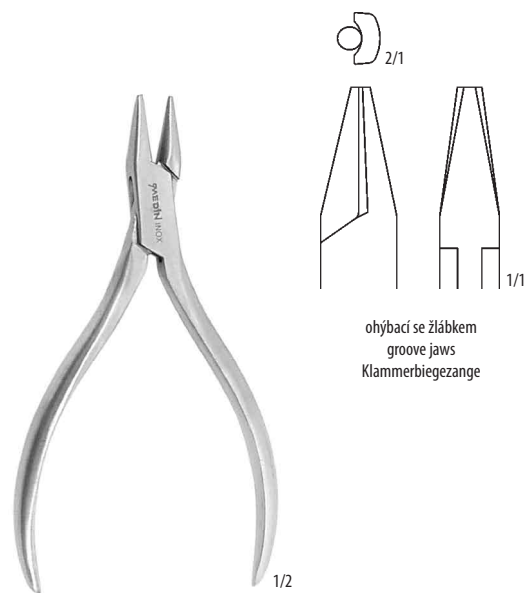

117 52 0860
13,0 cm
pro tvrdý drát do průměru 0,9 mm
for hard wires up to diameter 0,9 mm
für harten Draht bis Durchmesser 0,9 mm
Fig. 3

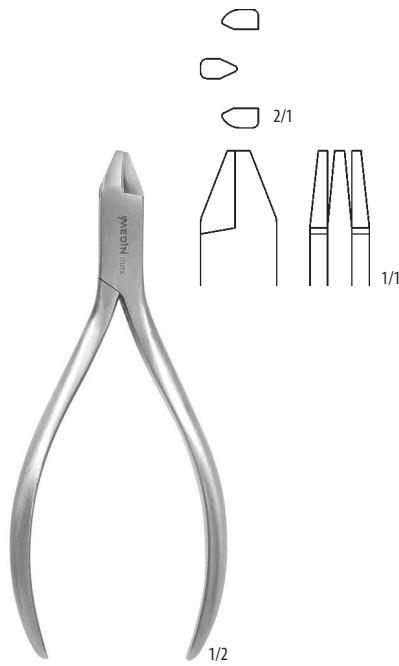
**117 52 0880**

12,2 cm

pro tvrdý drát do průměru 0,7 mm
for hard wires up to diameter 0,7 mm
für harten Draht bis Durchmesser 0,7 mm

Fig. 5

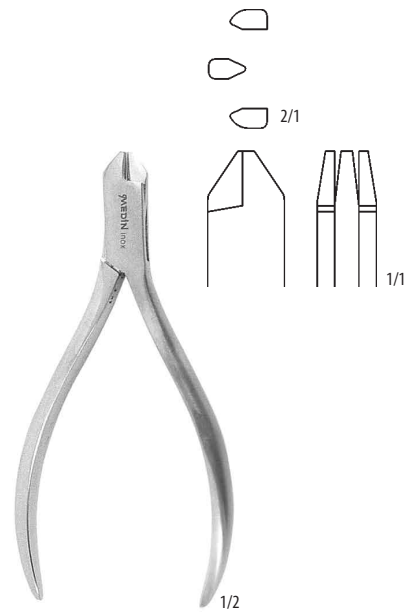
**117 52 0890**

11,9 cm

pro tvrdý drát do průměru 0,9 mm
for hard wires up to diameter 0,9 mm
für harten Draht bis Durchmesser 0,9 mm

Fig. 6

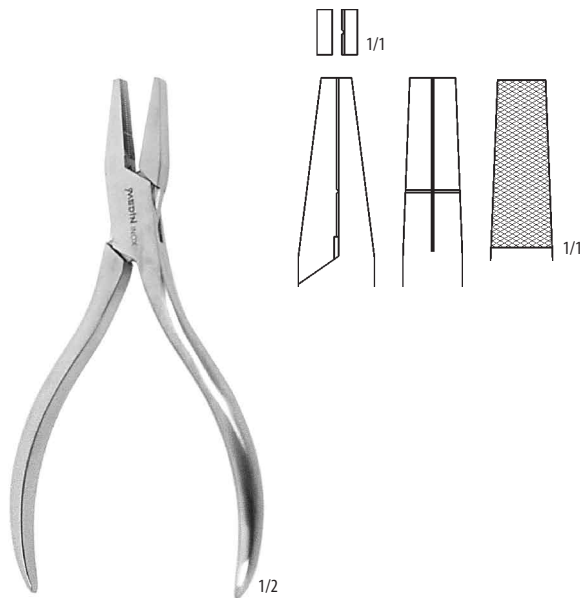
**117 52 1000**

utahovací – tightening

13,6 cm

pro tvrdý drát do průměru 1,2 mm
for hard wires up to diameter 1,2 mm
für harten Draht bis Durchmesser 1,2 mm

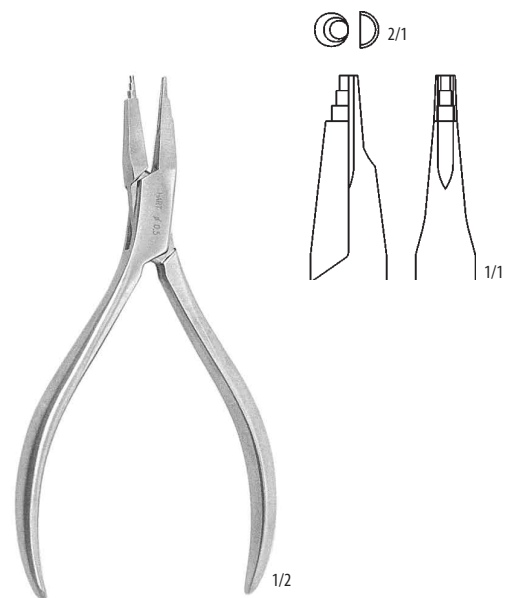
**117 52 1010**

13,6 cm

pro tvrdý drát do průměru 1,5 mm
for hard wires up to diameter 1,5 mm
für harten Draht bis Durchmesser 1,5 mm



PINZETY	FORCEPS	PINZETTEN	119
NŮŽKY	SCISSORS	SCHEREN	120
PILKY	SAWS	SÄGEN	120
LOPATKY	SPATULAS	SPATELN	121
LŽIČKY LABORATORNÍ	LABORATORY SPOONS	LABORLÖFFEL	121
STOMATOLOGICKÉ SOUBORY	STOMATOLOGICAL SETS	DENTAL-SÄTZE	122
NÁSTROJE MODELOVACÍ	MODELLING INSTRUMENTS	MODELLIERINSTRUMENTE	123–125
KLADIVA	MALLETS	HÄMMER	126
KYVETY, TŘMENY, LISY	FLASKS, CLAPS, PRESSES	KÜVETTEN, BÜGEL, PRESSEN	127–128
POMŮCKY PRO LITÍ	CASTING DEVICES	GIESSINSTRUMENTE	129–130
ZUBNÍ NÁHRADY	TOOTH REPLACEMENT	ZAHNERSÄTZE	130
OTISKOVACÍ LŽÍČE	IMPRESSION TRAYS	ABDRUCKLÖFFEL	131–134



PINZETA LABORATORNÍ
 CROSS-ACTION FORCEPS
 LÖTPINZETTEN
114 52 0100
 15,3 cm



PINZETA LABORATORNÍ
 CROSS-ACTION FORCEPS
 LÖTPINZETTEN
114 52 0101
 15,3 cm

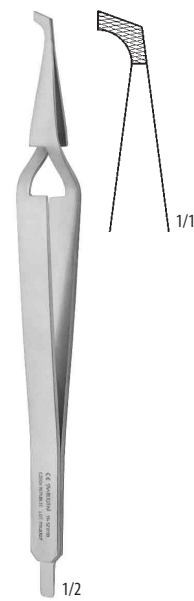

PINZETA ZKŘÍŽENÁ SE ŠROUBOVÁKEM
 CROSS-ACTION FORCEPS WITH SCREWDRIVER
 LÖTPINZETTEN MIT SCHRAUBENZIEHER
114 52 0110
 15,5 cm

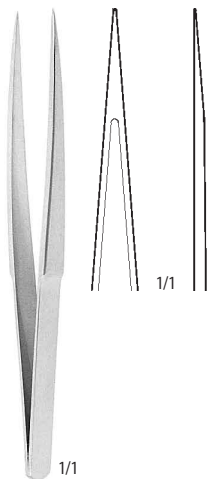

PINZETA LABORATORNÍ
 LABORATORY FORCEPS
 LABORPINZETTE
114 52 0020
 hrotnatá – pointed – spitzten
 12,5 cm

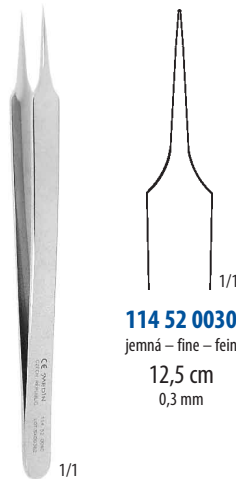

PINZETA LABORATORNÍ
 LABORATORY FORCEPS
 LABORPINZETTE
114 52 0030
 12,5 cm

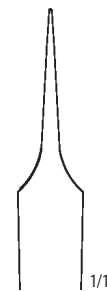

114 52 0040
 jemná – fine – fein
 12,5 cm
 0,4 mm

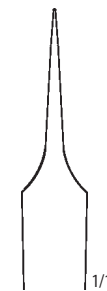

114 52 0050
 jemná – fine – fein
 11,0 cm
 0,3 mm

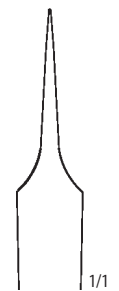

114 52 0060
 jemná – fine – fein
 11,0 cm
 0,4 mm

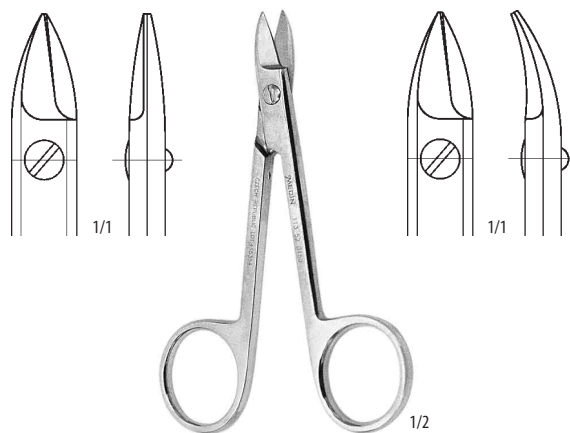

113 52 0150
rovné – straight – gerade

11,0 cm

113 52 0160
zahnuté – curved – gebogen

PILKY STOMATOLOGICKÉ
STOMATOLOGICAL SAWS
STOMATOLOGISCHE SÄGE

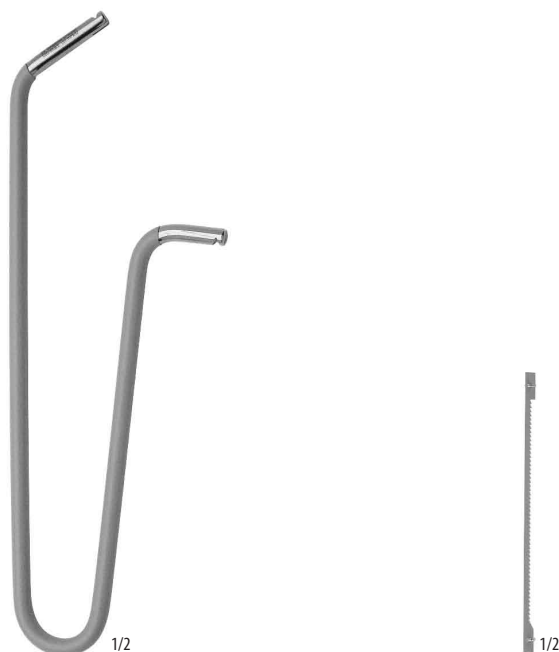

UPÍNAČÍ RÁM PILKY STOMATOLOGICKÉ
FRAME OF STOMATOLOGICAL SAW
SÄGEBÜGEL
127 50 0150
190 × 65 cm

LIST K PILCE STOMATOLOGICKÉ
BLADE OF STOMATOLOGICAL SAW
SÄGEBLATT
127 50 0001
7,3 cm



1/2

NŮŽ NA SÁDRU
PLASTER KNIFE
GIPSMESSER
121 52 0050
18,0 cm



1/2

LOPATKA NA SÁDRU
PLASTER SPATULA
GIPSSPATEL
121 52 0060
16,8 cm
40/30 mm



1/2

LOPATKA NA MÍCHÁNÍ
MIXING SPATULA
SPATEL FÜR ABDRUCKMASSEN
121 52 0080
21,0 cm
27 mm



1/2

LOPATKA NA CEMENT
CEMENT SPATULA
ZEMENTSPATELN
121 52 0020
oboustranná – double faced – doppelendig
18,0 cm

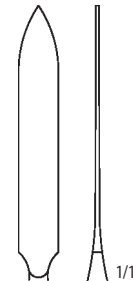

121 52 0010

18,0 cm
5,0 mm

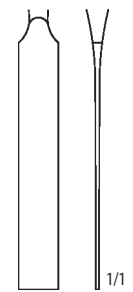

1/1

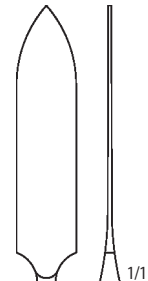

121 52 0020

18,0 cm
7,5 mm

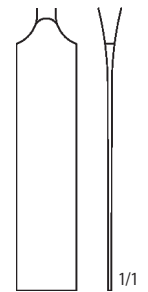

1/1



1/2

125 53 0010
15,0 cm



1/2

125 53 0020
20,0 cm



1/2

139 50 0360

soubor – set – Set

			počet ks – number of pcs – Anzahl
114 50 0011	PINZETA ZUBNÍ	DENTAL FORCEPS	1
115 08 0020	SVORKA ZAHNUTÁ	FORCEPS BENT	1
117 52 0700	KLEŠTĚ LABORATORNÍ; FIG. 1	LABORATORY FORCEPS; FIG. 1	1
121 52 0050	NŮŽ NA SÁDRU	PLASTER KNIFE	1
155 52 0180	LE CRON MODELOVACÍ NÁSTROJ	LE CRON MODELLING INSTRUMENT	1
155 52 0212	NŮŽ MODELOVACÍ	MODELLING KNIFE	1
155 52 0222	NŮŽ MODELOVACÍ	MODELLING KNIFE	1
		ZAHNPINZETTE	1
		KLEMME GERADE	1
		KRAMPONZANGE; Fig 1	1
		GIPSMESSER	1
		LE CRON MODELLIERINSTRUMENT	1
		WACHSMESSER	1
		WACHSMESSER	1

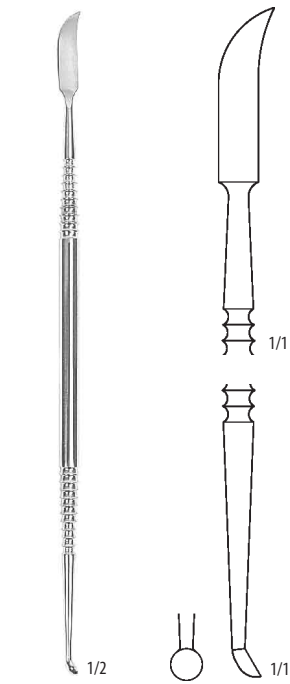

LE CRON
155 52 0180
17,5 cm



155 52 0212
13,0 cm



155 52 0222
17,4 cm



155 52 1402

16,2 cm
Fig. 1



155 52 1412

16,4 cm
Fig. 2



155 52 1422

16,7 cm
Fig. 3

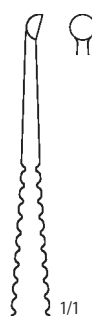

155 52 1422

16,7 cm
Fig. 3

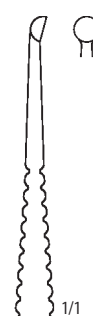

155 52 1432

16,5 cm
Fig. 4

155 52 1402

16,2 cm
Fig. 1

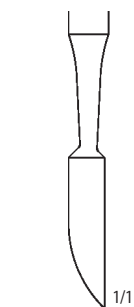

155 52 1442

16,2 cm
Fig. 5

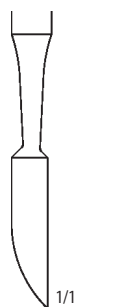

155 52 1442

16,2 cm
Fig. 5



155 52 1452

16,8 cm
Fig. 6



155 52 1462

15,6 cm
Fig. 7

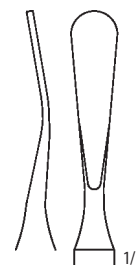

155 52 1472

15,9 cm
Fig. 8



155 52 1482

15,9 cm
Fig. 9



155 52 1472

15,9 cm
Fig. 8



1/2

155 52 9000

soubor – set – Set

20,0 × 12,0 × 2,8 cm

			počet ks – number of pcs – Anzahl	
112 91 0004	DRŽÁK SKALPELOVÝCH ČEPELEK, vel. 4	SCALPEL HANDLE, No. 4	SKALPELLGRIFF, Nr. 4	1
114 08 0101	PINZETA ANATOMICKÁ, rovná, jemná	DRESSING FORCEPS, straight, fine	ANATOMISCHE PINZETTE, gerade, fein	1
115 08 0010	MOSQUITO-HALSTEAD SVORKA, rovná	MOSQUITO-HALSTEAD FORCEPS, straight	MOSQUITO-HALSTEAD KLEMME, gerade	1
155 52 1402	MODELOVACÍ NÁSTROJ, Fig. 1	MODELLING INSTRUMENT, Fig. 1	MODELLIERINSTRUMENTE, Fig. 1	1
155 52 1412	MODELOVACÍ NÁSTROJ, Fig. 2	MODELLING INSTRUMENT, Fig. 2	MODELLIERINSTRUMENTE, Fig. 2	1
155 52 1422	MODELOVACÍ NÁSTROJ, Fig. 3	MODELLING INSTRUMENT, Fig. 3	MODELLIERINSTRUMENTE, Fig. 3	1
155 52 1432	MODELOVACÍ NÁSTROJ, Fig. 4	MODELLING INSTRUMENT, Fig. 4	MODELLIERINSTRUMENTE, Fig. 4	1
155 52 1442	MODELOVACÍ NÁSTROJ, Fig. 5	MODELLING INSTRUMENT, Fig. 5	MODELLIERINSTRUMENTE, Fig. 5	1
155 52 1452	MODELOVACÍ NÁSTROJ, Fig. 6	MODELLING INSTRUMENT, Fig. 6	MODELLIERINSTRUMENTE, Fig. 6	1
155 52 1462	MODELOVACÍ NÁSTROJ, Fig. 7	MODELLING INSTRUMENT, Fig. 7	MODELLIERINSTRUMENTE, Fig. 7	1
155 52 1472	MODELOVACÍ NÁSTROJ, Fig. 8	MODELLING INSTRUMENT, Fig. 8	MODELLIERINSTRUMENTE, Fig. 8	1
155 52 1482	MODELOVACÍ NÁSTROJ, Fig. 9	MODELLING INSTRUMENT, Fig. 9	MODELLIERINSTRUMENTE, Fig. 9	1



1/2

KLADÍVKO LABORATORNÍ
LABORATORY Mallet
LABORHAMMER

128 52 0110

vypouklé, leštěné – convex, polished – konvex

26,0 cm



1/2

KLADÍVKO LABORATORNÍ
LABORATORY Mallet
LABORHAMMER

128 52 0111

rovné, matované – straight, mat – gerade, mattiert

26,0 cm

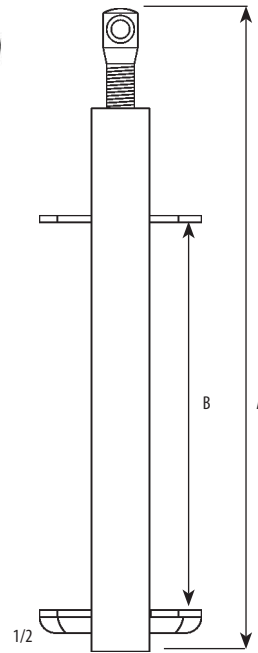

157 52 0030 TŘMEN PRO JEDNU KYVETU
157 52 0040 TŘMEN PRO DVĚ KYVETY
157 52 0050 TŘMEN PRO TŘI KYVETY

CLAP FOR ONE FLASK
 CLAP FOR TWO FLASKS
 CLAP FOR THREE FLASKS

FÜR 1 KÜVETTE
 FÜR 2 KÜVETTEN
 FÜR 3 KÜVETTEN

A	B
17,0 cm	6,4 cm
22,5 cm	12,0 cm
28,0 cm	17,5 cm



KYVETA ČTYŘDÍLNÁ
FOUR PIECE FLASK
VIERTERLIGKÜVETTE

157 52 0021

nerez – stainless steel – rostfrei Stahl

12,6 × 9,3 × 5,3 cm

157 52 0031

mosaz – brass – messing

12,6 × 9,3 × 5,3 cm



KYVETA KORUNKOVÁ
CROWN FLASK
KRONENKÜVETTE

157 52 0011

nerez – stainless steel – rostfrei Stahl

5,0 cm
Ø 5,5 cm



OPĚRKA KYVETY KORUNKOVÉ
SUPPORT OF CROWN FLASK
KRONENKÜVETTENSTÜTZE

157 52 0210

3,0 cm
Ø 6,0 cm

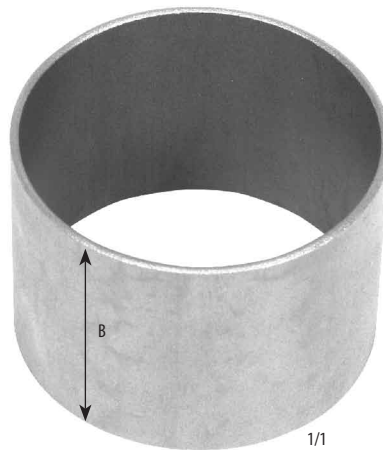
158 99 0023

 ocel – steel – Stahl
 5,5 cm

	Ø	B
158 99 0025	3,0 cm	5,5 cm
158 99 0022	3,8 cm	5,5 cm
158 99 0023	4,8 cm	5,5 cm
158 99 0024	6,5 cm	5,5 cm
158 99 0026	8,0 cm	5,5 cm

 PODLOŽKA POD LICÍ KROUŽKY
 WASHER FOR CASTING RINGS
 MUFFELRINGFORMER

158 91 0001

 guma – rubber – Gummi
 Ø 9,0 cm

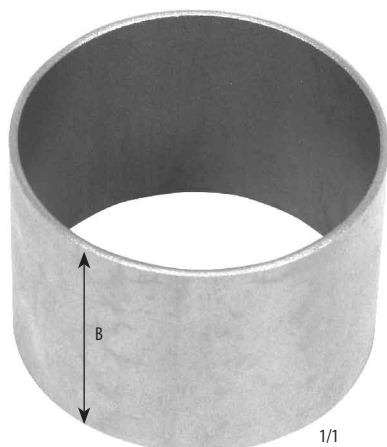
KROUŽKY KOVOVÉ LICÍ
CASTING RINGS
MUFFELRING**158 52 0050**ocel – steel – Stahl
5,5 cm

	Ø	B
158 52 0010	2,2 cm	3,0 cm
158 52 0020	2,8 cm	4,0 cm
158 52 0030	4,0 cm	4,5 cm
158 52 0040	4,0 cm	4,8 cm
158 52 0050	5,0 cm	5,5 cm
158 52 0060	6,0 cm	5,5 cm
158 52 0070	7,0 cm	5,5 cm
158 52 0080	8,0 cm	5,5 cm
158 52 0090	2,5 cm	3,5 cm

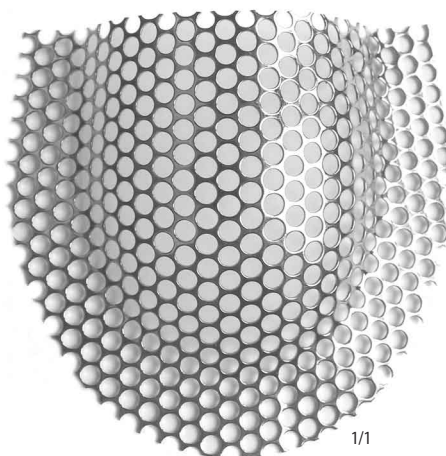
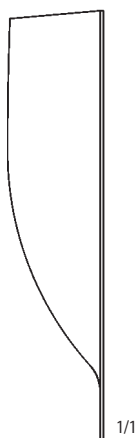
ZESILOVACÍ MŘÍŽKY
MESH STRENGTHENERS
VERSTÄRKUNGSNETZ FÜR PROTHESEN**152 52 1900**zlacená – gold plated – vergoldet
60 × 54 × 12 mm**152 52 1910**nerezová – stainless – rostfrei
60 × 54 × 12 mm



1/2

154 52 9011

 s retenčním okrajem
 with retentive edge
 mit Retentionsrand

154 52 9010	H1
154 52 9011	H2
154 52 9012	H3
154 52 9013	H4



1/2

154 52 9019

 s retenčním okrajem, perforované
 with retentive edge, perforated
 mit Retentionsrand , perforiert

154 52 9018	HX1
154 52 9019	HX2
154 52 9020	HX3
154 52 9021	HX4



1/2

154 52 0110

 perforované
 perforated
 perforiert

154 52 0110	BOX1
154 52 0120	BOX2
154 52 0130	BOX3
154 52 0140	BOX4



1/2

154 52 9015

 s retenčním okrajem
 with retentive edge
 mit Retentionsrand

154 52 9014	D1
154 52 9015	D2
154 52 9016	D3
154 52 9017	D4



1/2

154 52 9023

 s retenčním okrajem, perforované
 with retentive edge, perforated
 mit Retentionsrand , perforiert

154 52 9022	DX1
154 52 9023	DX2
154 52 9024	DX3
154 52 9025	DX4



1/2

154 52 0270

 perforované
 perforated
 perforiert

154 52 0260	FX1
154 52 0270	FX2
154 52 0280	FX3

**154 52 0370**pro horní čelist, perforovaná
for upper jaws, perforated
für Oberkiefer, perforiert**154 52 0360**

DHX1

154 52 0370

DHX2

154 52 0380

DHX3

**154 52 0460**pro dolní čelist, perforovaná
for lower jaws, perforated
für Unterkiefer, perforiert**154 52 0460**

DDX1

154 52 0470

DDX2

154 52 0480

DDX3

**154 52 0560**poloviční levá perforovaná
for partial impressions left perforated
für Partieller-Abdrucklöffel, links, perforiert
PLX**154 52 0550**poloviční pravá perforovaná
for partial impressions right perforated
für Partieller-Abdrucklöffel, rechts, perforiert
PPX**154 52 0600**korunková
crown
Krone



1/2

154 52 0620

 horní, perforovaná
 upper, perforated
 Oberkiefer, perforiert

154 52 0610	FOX1
154 52 0620	FOX2
154 52 0630	FOX3
154 52 0640	FOX4



1/2

154 52 0690

 dolní, perforovaná
 lower, perforated
 Unterkiefer, perforiert

154 52 0660	UUX1
154 52 0670	UUX2
154 52 0680	UUX3
154 52 0690	UUX4

 OTISKOVACÍ LŽÍCE PRO ČÁSTEČNĚ OZUBENOU ČELIST
 IMPRESSION TRAYS FOR PARTIALLY TOOTHED JAWS
 ABDRUCKLÖFFEL FÜR TEILBEZAHNTEN KIEFER

1/2

154 52 0790

 horní, perforovaná
 upper, perforated
 Oberkiefer, perforiert
BOXC3

1/2

154 52 0830

 dolní, perforovaná
 lower, perforated
 Unterkiefer, perforiert

154 52 0820	FXC2
154 52 0830	FXC3



OTISKOVACÍ LŽÍČE – SOUBOR
IMPRESSION TRAYS – SET
ABDRUCKLÖFFEL – SET

154 52 1550

soubor – set – Set

perforované – perforated – perforiert

154 52 0110	BOX1
154 52 0120	BOX2
154 52 0130	BOX3
154 52 0140	BOX4
154 52 0260	FX1
154 52 0270	FX2
154 52 0280	FX3
154 52 0550	PPX
154 52 0560	PLX

OTISKOVACÍ LŽÍČE DĚTSKÉ – SOUBOR
IMPRESSION TRAYS CHILDREN – SET
ABDRUCKLÖFFEL FÜR KINDER – SET

154 52 1650

soubor – set – Set

perforované – perforated – perforiert

154 52 0360	DHX1
154 52 0370	DHX2
154 52 0380	DHX3
154 52 0460	DDX1
154 52 0470	DDX2
154 52 0480	DDX3

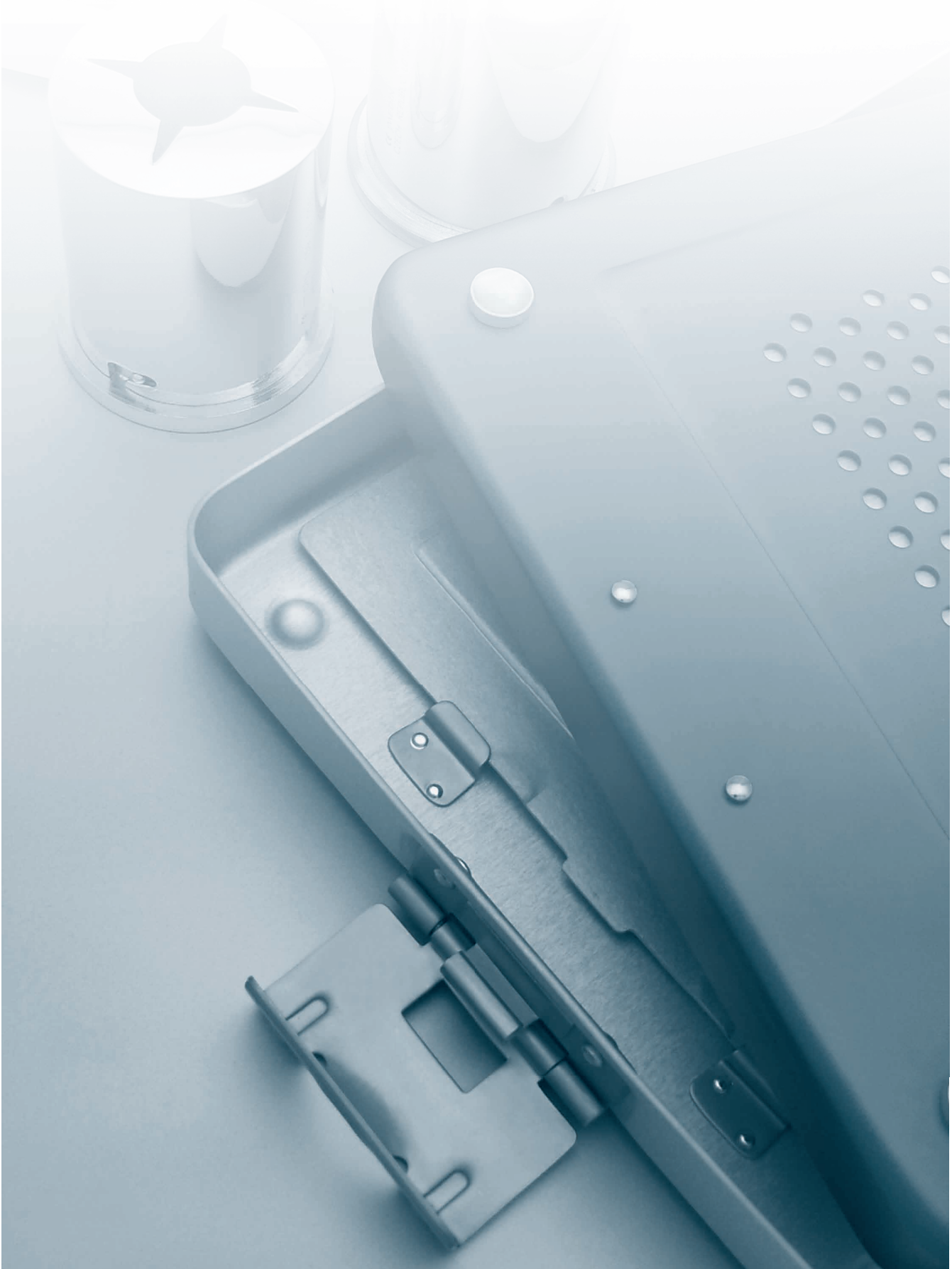

NÁDOBKY	BOXES	DOSEN	137
DRŽÁTKA UBROUSKU	NAPKIN HOLDERS	SERVIETTENHALTER	137
TOULCE	QUIVERS	STANDGEFÄSS	138
KAZETY, NÁDOBKY	CASSETTES, BOWLS	KASSETTEN, BOWLEN	139
KRABÍČKY	BOXES	DOSEN	139–140
TÁČKY	TRAYS	PLATTEN	141
KRABÍČKY	BOXES	DOSEN	142
BUBNY STERILIZAČNÍ	STERILIZATION DRUMS	STERILISATION TROMMELN	142–143
STERILIZAČNÍ KONTEJNERY	CONTAINERS FOR STERILIZATION	STERILISATIONS-CONTAINERS	144–148



NÁDOBKA NA VATU S PRUŽINOU
COTTON WOOL BOX WITH SPRING
WATTEBEHÄLTER

159 53 0050

7,5 cm
Ø 5,0 cm



NÁDOBKA NA VATOVÉ ODPADKY
COTTON WOOL BIN
WATTMÜLLBEHÄLTER

159 53 0060

6,5 cm
Ø 5,0 cm

DRŽÁTKA UBROUSKU
NAPKIN HOLDERS
SERVIETTENHALTER



DRŽÁTKO UBROUSKU ŘETÍZKOVÉ
NAPKIN HOLDER WITH METAL CHAIN
SERVIETTENHALTER

159 53 0100

47,0 cm
umělohmotné svorky – plastic clips – Plastikklappen



DRŽÁTKO UBROUSKU UH
NAPKIN HOLDER
SERVIETTENHALTER

159 53 0110

48,0 cm
kovové svorky Aligátor – metal clips Aligator – metallisches Krokodilklemmen



DRŽÁTKO UBROUSKU ŘETÍZKOVÉ
NAPKIN HOLDER WITH METAL CHAIN
SERVIETTENHALTER

159 53 0120

23,0 cm
kovové svorky Aligátor – metal clips Aligator – metallisches Krokodilklemmen



1/2

136 39 0010

9,0 cm

na pinzety – for tweezers – für Pinzetten
Ø 4,7 cm

1/2

136 39 0030

9,0 cm

na pinzety – for tweezers – für Pinzetten
Ø 4,3 cm
matovaný – mat – mattiert

1/2

136 39 0020

20,0 cm

na podávkové kleště – for forceps – für Zangen
Ø 6,6 cm

1/2

136 39 0040

20,0 cm

na podávkové kleště – for forceps – für Zangen
Ø 7,0 cm
matovaný – mat – mattiert



DRŽÁK
HOLDER
HALTER

139 50 0150
aluminium

21,0 × 9,6 × 1,6 cm



KAZETA S DRŽÁKEM
CASSETTE WITH HOLDER
KASSETTE MIT HALTER

139 50 0160
aluminium

22,0 × 10,5 × 3,6 cm



KAZETA
CASSETTE
KASSETTE

139 50 0170
aluminium

22,0 × 10,5 × 3,6 cm

NÁDOBKY
BOWLS
BOWLEN



136 39 0260

nerez – stainless steel – rostfreier Stahl
175 × 100 × 25 mm



136 39 0270

nerez – stainless steel – rostfreier Stahl
90 × 40 mm



136 39 0320

nerez – stainless steel – rostfreier Stahl
82 × 30 mm

KRABÍČKY STERILIZAČNÍ PRO HORKOVZDUŠNOU STERILIZACI
STERILIZATION BOXES FOR DRY-HEAT STERILIZATION
STERILISIERDOSEN FÜR HEISSLUFTSTERILISIERUNG



136 39 0140

nerez – stainless steel – rostfreier Stahl
200 × 100 × 30 mm



136 39 0150

nerez – stainless steel – rostfreier Stahl
170 × 70 × 30 mm



136 39 0160

nerez – stainless steel – rostfreier Stahl
200 × 100 × 40 mm



136 39 0170
nerez – stainless steel – rostfreier Stahl
210×115×45 mm



136 39 0180
nerez – stainless steel – rostfreier Stahl
dvoji víčko – double lid – doppelter Deckel
210×110×25 mm



136 39 0190
nerez – stainless steel – rostfreier Stahl
210×115×45 mm



136 39 0200
nerez – stainless steel – rostfreier Stahl
na katetry – for catheters – für Katheter
300×80×40 mm



136 39 0220
nerez – stainless steel – rostfreier Stahl
350×90×50 mm



136 39 0230
nerez – stainless steel – rostfreier Stahl
230×150×60 mm



136 39 0240
nerez – stainless steel – rostfreier Stahl
300×200×50 mm



136 39 0250
nerez – stainless steel – rostfreier Stahl
200×150×45 mm



136 39 0110

nerez – stainless steel – rostfreier Stahl

180×120×15 mm



136 39 0330

nerez – stainless steel – rostfreier Stahl

200×100×10 mm



136 39 0340

nerez – stainless steel – rostfreier Stahl

190×100×10 mm



136 39 0350

nerez – stainless steel – rostfreier Stahl

200×100×30 mm



136 39 0360

nerez – stainless steel – rostfreier Stahl

190×100×10 mm



136 39 0370

nerez – stainless steel – rostfreier Stahl

280×190×20 mm



136 39 0380

nerez – stainless steel – rostfreier Stahl

350×250×20 mm



136 39 0210
nerez – stainless steel – rostfreier Stahl
92×40×17 mm



136 39 0410
plast – plastic – Plastik
na umělý chrup – for denture – für prothese oder KFO apparat
80×80×40 mm

BUBNY STERILIZAČNÍ PRO HORKOVZDUŠNOU STERILIZACI
STERILIZATION DRUMS FOR DRY-HEAT STERILIZATION
STERILISATION TROMMELN FÜR HEISSLUFTSTERILISIERUNG



BUBEN STERILIZAČNÍ
STERILIZATION DRUM
STERILISATION TROMMEL

136 91 1314	125×80 mm	136 91 1333	240×165 mm	136 91 1352	340×290 mm
136 91 1315	125×100 mm	136 91 1334	240×190 mm	136 91 1353	340×340 mm
136 91 1316	125×125 mm	136 91 1335	240×240 mm	136 91 1354	340×390 mm
136 91 1317	150×80 mm	136 91 1336	240×290 mm	136 91 1355	390×140 mm
136 91 1318	150×100 mm	136 91 1337	240×340 mm	136 91 1356	390×165 mm
136 91 1319	150×130 mm	136 91 1338	240×390 mm	136 91 1357	390×190 mm
136 91 1320	150×150 mm	136 91 1339	290×120 mm	136 91 1358	390×240 mm
136 91 1321	150×190 mm	136 91 1340	290×145 mm	136 91 1359	390×290 mm
136 91 1322	150×240 mm	136 91 1341	290×165 mm	136 91 1360	390×340 mm
136 91 1323	190×95 mm	136 91 1342	290×190 mm	136 91 1361	390×390 mm
136 91 1324	190×125 mm	136 91 1343	290×240 mm	136 91 1362	390×490 mm
136 91 1325	190×145 mm	136 91 1344	290×290 mm	136 91 1363	390×590 mm
136 91 1326	190×165 mm	136 91 1345	290×340 mm	136 91 1364	480×165 mm
136 91 1327	190×190 mm	136 91 1346	290×390 mm	136 91 1365	480×190 mm
136 91 1328	190×240 mm	136 91 1347	340×120 mm	136 91 1366	480×240 mm
136 91 1329	190×290 mm	136 91 1348	340×145 mm	136 91 1367	480×290 mm
136 91 1330	240×95 mm	136 91 1349	340×165 mm	136 91 1368	480×340 mm
136 91 1331	240×120 mm	136 91 1350	340×190 mm	136 91 1369	480×390 mm
136 91 1332	240×145 mm	136 91 1351	340×240 mm		



BUBEN STERILIZAČNÍ
 STERILIZATION DRUM
 STERILISATION TROMMEL

136 91 1275	125×80 mm	136 91 1288	190×240 mm	136 91 1301	340×120 mm
136 91 1276	125×100 mm	136 91 1289	190×290 mm	136 91 1302	340×145 mm
136 91 1277	125×125 mm	136 91 1290	240×120 mm	136 91 1303	340×165 mm
136 91 1278	150×100 mm	136 91 1291	240×165 mm	136 91 1304	340×190 mm
136 91 1279	150×130 mm	136 91 1292	240×190 mm	136 91 1305	340×240 mm
136 91 1280	150×150 mm	136 91 1293	240×240 mm	136 91 1306	340×290 mm
136 91 1281	150×190 mm	136 91 1294	240×290 mm	136 91 1307	390×140 mm
136 91 1282	150×240 mm	136 91 1295	290×120 mm	136 91 1308	390×165 mm
136 91 1283	190×95 mm	136 91 1296	290×145 mm	136 91 1309	390×190 mm
136 91 1284	190×125 mm	136 91 1297	290×165 mm	136 91 1310	390×240 mm
136 91 1285	190×145 mm	136 91 1298	290×190 mm	136 91 1311	390×290 mm
136 91 1286	190×165 mm	136 91 1299	290×240 mm	136 91 1312	390×340 mm
136 91 1287	190×190 mm	136 91 1300	290×290 mm	136 91 1313	390×390 mm

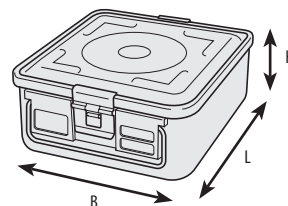
KONTEJNERY
CONTAINERS – CONTAINERS

L	B	H	STŘÍBRNÉ SILVER SILBER	MODRÉ BLUE BLAU	ČERVENÉ RED ROT	ZELENÉ GREEN GRÜN	ZLATÉ GOLD GOLD	ČERNÉ BLACK SCHWARZ
285 × 280 × 100 mm			136 91 0259	136 91 0260	136 91 0261	136 91 0262	136 91 0263	136 91 0264
285 × 280 × 135 mm			136 91 0265	136 91 0266	136 91 0267	136 91 0268	136 91 0269	136 91 0270
285 × 280 × 150 mm			136 91 0271	136 91 0272	136 91 0273	136 91 0274	136 91 0275	136 91 0276
285 × 280 × 200 mm			136 91 0277	136 91 0278	136 91 0279	136 91 0280	136 91 0281	136 91 0282
285 × 280 × 260 mm			136 91 0283	136 91 0284	136 91 0285	136 91 0286	136 91 0287	136 91 0288
285 × 280 × 110 mm			136 91 0337	136 91 0338	136 91 0339	136 91 0340	136 91 0341	136 91 0342
285 × 280 × 135 mm			136 91 0343	136 91 0344	136 91 0345	136 91 0346	136 91 0347	136 91 0348
285 × 280 × 150 mm			136 91 0349	136 91 0350	136 91 0351	136 91 0352	136 91 0353	136 91 0354
285 × 280 × 200 mm			136 91 0355	136 91 0356	136 91 0357	136 91 0358	136 91 0359	136 91 0360
285 × 280 × 260 mm			136 91 0361	136 91 0362	136 91 0363	136 91 0364	136 91 0365	136 91 0366

barevná pouze víka
lid colored only
nur Deckel farbig

VÍKA – LIDS – DECKEL



L	B	STŘÍBRNÁ SILVER SILBER	MODRÁ BLUE BLAU	ČERVENÁ RED ROT	ZELENÁ GREEN GRÜN	ZLATÁ GOLD GOLD	ČERNÁ BLACK SCHWARZ
285 × 280 mm		136 91 0415	136 91 0416	136 91 0417	136 91 0418	136 91 0419	136 91 0420
285 × 280 mm		136 91 0438	136 91 0439	136 91 0440	136 91 0441	136 91 0442	136 91 0443
285 × 280 mm		136 91 0490	136 91 0491	136 91 0492	136 91 0493	136 91 0494	136 91 0495

VANY – BOTTOMS – BODEN

barevná pouze víka
lid colored only
nur Deckel farbig

L	B	H	
285 × 280 × 100 mm			136 91 0463
285 × 280 × 135 mm			136 91 0464
285 × 280 × 150 mm			136 91 0465
285 × 280 × 200 mm			136 91 0466
285 × 280 × 260 mm			136 91 0467
285 × 280 × 100 mm			136 91 0475
285 × 280 × 135 mm			136 91 0476
285 × 280 × 150 mm			136 91 0477
285 × 280 × 200 mm			136 91 0478
285 × 280 × 260 mm			136 91 0479

KOŠE – BASKET – SIEBKÖRBE



L	B	H	
255 × 245 × 30 mm			136 91 0526
255 × 245 × 50 mm			136 91 0527
255 × 245 × 70 mm			136 91 0528
255 × 245 × 100 mm			136 91 0529

SÍTO – DIVIDER – TEILER



L	B	H	
255 × 245 × 130 mm			136 91 0675

RÁMY – RETAINERS – SPANNRAHMEN

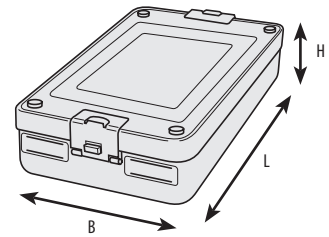

L	B	H	
255 × 255		mm	136 91 0667
255 × 255 × 30 mm			136 91 0668

 KONTEJNERY
 CONTAINERS – CONTAINERS

 barevná pouze víka
 lid colored only
 nur Deckel farbig

L	B	H	STŘÍBRNÁ SILVER SILBER	MODRÁ BLUE BLAU	ČERVENÁ RED ROT	ZELENÁ GREEN GRÜN	ZLATÁ GOLD GOLD	ČERNÁ BLACK SCHWARZ
310 × 190 × 40 mm			136 91 0696	136 91 0697	136 91 0698	136 91 0699	136 91 0700	136 91 0701
310 × 190 × 65 mm			136 91 0702	136 91 0703	136 91 0704	136 91 0705	136 91 0706	136 91 0707
310 × 190 × 130 mm			136 91 0708	136 91 0709	136 91 0710	136 91 0711	136 91 0712	136 91 0713
310 × 190 × 40 mm			136 91 0714	136 91 0715	136 91 0716	136 91 0717	136 91 0718	136 91 0719
310 × 190 × 65 mm			136 91 0720	136 91 0721	136 91 0722	136 91 0723	136 91 0724	136 91 0725
310 × 190 × 130 mm			136 91 0726	136 91 0727	136 91 0728	136 91 0729	136 91 0730	136 91 0731

VÍKA – LIDS – DECKEL



L	B	STŘÍBRNÁ SILVER SILBER	MODRÁ BLUE BLAU	ČERVENÁ RED ROT	ZELENÁ GREEN GRÜN	ZLATÁ GOLD GOLD	ČERNÁ BLACK SCHWARZ
310 × 190 mm		136 91 0645	136 91 0646	136 91 0647	136 91 0648	136 91 0649	136 91 0650
310 × 190 mm		136 91 0653	136 91 0654	136 91 0655	136 91 0656	136 91 0657	136 91 0658

VANY – BOTTOMS – BODEN

 barevná pouze víka
 lid colored only
 nur Deckel farbig

L	B	H	STŘÍBRNÁ SILVER SILBER
310 × 190 × 40 mm			136 91 0690
310 × 190 × 65 mm			136 91 0691
310 × 190 × 130 mm			136 91 0692
310 × 190 × 40 mm			136 91 0693
310 × 190 × 65 mm			136 91 0694
310 × 190 × 130 mm			136 91 0695

KOŠ – BASKET – SIEBKÖRBE



L	B	H	STŘÍBRNÁ SILVER SILBER
274 × 172 × 43 mm			136 91 0662

RÁMY – RETAINERS – SPANNRAHMEN

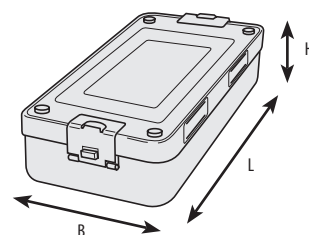
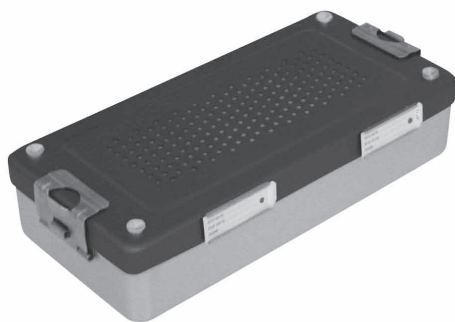

L	B	STŘÍBRNÁ SILVER SILBER
270 × 170 mm		136 91 0669

KONTEJNERY MINI
SMALL CONTAINERS
KLEIN CONTAINER

 KONTEJNERY
CONTAINERS – CONTAINERS

 barevná pouze víka
lid colored only
nur Deckel farbig

L	B	H	STŘÍBRNÁ SILVER SILBER	MODRÉ BLUE BLAU	ČERVENÉ RED ROT	ZELENÉ GREEN GRÜN	ZLATÉ GOLD GOLD	ČERNÉ BLACK SCHWARZ
300 × 140 × 40 mm			136 91 0569	136 91 0570	136 91 0571	136 91 0572	136 91 0573	136 91 0684
300 × 140 × 70 mm			136 91 0574	136 91 0575	136 91 0576	136 91 0577	136 91 0578	136 91 0685
300 × 140 × 100 mm			136 91 0579	136 91 0580	136 91 0581	136 91 0582	136 91 0583	136 91 0686
300 × 140 × 40 mm			136 91 0584	136 91 0585	136 91 0586	136 91 0587	136 91 0588	136 91 0687
300 × 140 × 70 mm			136 91 0589	136 91 0590	136 91 0591	136 91 0592	136 91 0593	136 91 0688
300 × 140 × 100 mm			136 91 0594	136 91 0595	136 91 0596	136 91 0597	136 91 0598	136 91 0689

VÍKA – LIDS – DECKEL



L	B	STŘÍBRNÁ SILVER SILBER	MODRÁ BLUE BLAU	ČERVENÁ RED ROT	ZELENÁ GREEN GRÜN	ZLATÁ GOLD GOLD	ČERNÁ BLACK SCHWARZ
300 × 140 mm		136 91 0485	136 91 0486	136 91 0487	136 91 0488	136 91 0489	136 91 0652
300 × 140 mm		136 91 0513	136 91 0514	136 91 0515	136 91 0516	136 91 0517	136 91 0659

VANY – BOTTOMS – BODEN

 barevná pouze víka
lid colored only
nur Deckel farbig

L	B	H	
300 × 140 × 40 mm			136 91 0599
300 × 140 × 70 mm			136 91 0600
300 × 140 × 100 mm			136 91 0601
300 × 140 × 40 mm			136 91 0602
300 × 140 × 70 mm			136 91 0603
300 × 140 × 100 mm			136 91 0604

KOŠ – BASKET – SIEBKÖRBE



L	B	H	
267 × 125 × 50 mm			136 91 0661

SÍTO – DIVIDER – SIEBEINLAGE



L	B	
270 × 125 mm		136 91 0660

RÁMY – RETAINERS – SPANNRAHMEN

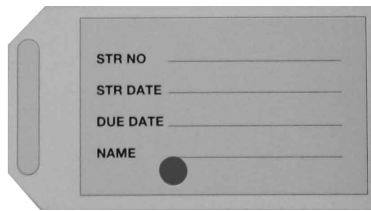

L	B	
270 × 155 mm		136 91 0670

ŠTÍTKY IDENTIFIKAČNÍ PAPIROVÉ
 PAPER LABELS WITH INDICATOR
 INDIKATORSCHILDER AUS PAPIER

136 91 0540
 STANDARD – STANDARD – STANDARD
 100 ks/pcs/Stk

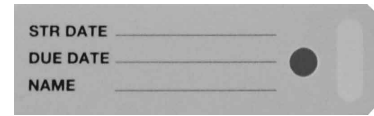

136 91 0541
 MALÝ – SMALL – KLEIN
 100 ks/pcs/Stk

 ŠTÍTKY IDENTIFIKAČNÍ
 IDENTIFICATION LABELS
 KENNZEICHNUNGSSCHILDER

	STŘÍBRNÝ SILVER SILBER	MODRÝ BLUE BLAU	ČERVENÝ RED ROT	ZELENÝ GREEN GRÜN	ZLATÝ GOLD GOLD	ČERNÝ BLACK SCHWARZ
136 91 0543	136 91 0544	136 91 0545	136 91 0546	136 91 0547	136 91 0548	

 ŠTÍTKY IDENTIFIKAČNÍ HLINÍKOVÉ PRO TEXT
 IDENTIFICATION ALUMINIUM LABELS ENGRAVE
 KENNZEICHNUNGSSCHILDER GRAVIERT

maximálně 12 znaků max. 12 digits max 12 Zeichen	STŘÍBRNÝ SILVER SILBER	MODRÝ BLUE BLAU	ČERVENÝ RED ROT	ZELENÝ GREEN GRÜN	ZLATÝ GOLD GOLD	ČERNÝ BLACK SCHWARZ
TEXT	136 91 0550	136 91 0551	136 91 0552	136 91 0553	136 91 0554	136 91 0555

 ZÁMEK BEZPEČNOSTNÍ PLASTOVÝ, PLOMBA PRO STERILIZAČNÍ KONTEJNERY
 PLASTIC SECURITY SEAL, SEAL FOR STERILIZING CONTAINERS
 SICHERHEITVERSCHLUSS PLASTIK

136 91 0542
 100 ks/pcs/Stk



285 499 54 7000
 100 ks/pcs/Stk

 FILTRY
 FILTERS
 FILTER

	typ – model – Typ	materiál – material – Material	balení – packing – Packung
136 91 0534	STANDARD – STANDARD	papír – paper – Papier	100 ks/pcs/Stk
136 91 0535	STANDARD – STANDARD	textil – textile – Textil	1 ks/pcs/Stk
136 91 0635	STANDARD – STANDARD	teflon – teflon – Teflon	1 ks/pcs/Stk
136 91 0536	MINI – SMALL – KLEIN	papír – paper – Papier	100 ks/pcs/Stk
136 91 0537	MINI – SMALL – KLEIN	textil – textile – Textil	1 ks/pcs/Stk
136 91 0676	DENTÁLNÍ – DENTAL	papír – paper – Papier	100 ks/pcs/Stk
136 91 0677	DENTÁLNÍ – DENTAL	textil – textile – Textil	1 ks/pcs/Stk

ROUŠKY TEXTILNÍ, ZELENÉ
GREEN CLOTHS
TÜCHER GRÜN

60 × 40 cm	136 91 0619
85 × 85 cm	136 91 0620
100 × 140 cm	136 91 0621
275 × 125 cm	136 91 0622
245 × 245 cm	136 91 0623

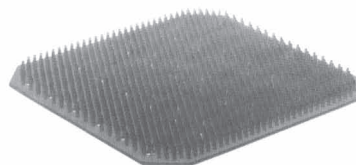
PODLOŽKY SILIKONOVÉ
SILICON MATS
NOPPENMATTEN SILIKON

275 × 125 mm	136 91 0624
225 × 225 mm	136 91 0625
300 × 300 mm	136 91 0626

Kompletní nabídku sterilizačních kontejnerů a příslušenství naleznete v katalogu STERILIZAČNÍ KONTEJNERY.

All of the range of containers for sterilization and accessories can be found in catalogue of CONTAINERS FOR STERILIZATION.

www.medin.cz

Katalog je dostupný na internetových stránkách MEDIN, a.s.
Tiskovou verzi katalogu si můžete vyžádat u našich obchodních zástupců.

The catalogue is available for download on our MEDIN, a.s., web sites.
Printed version is on request at our Sales Representatives.

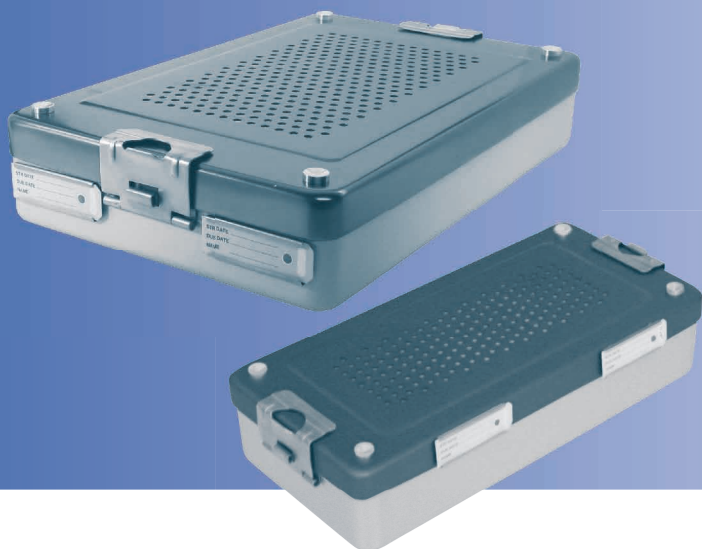

číslo – number	název	item	Artikel	strana – page
112	NÁSTROJE REZNÉ	CUTTING INSTRUMENTS	OPERATIONSSKALPELLE, SKALPELLKLINGEN	
112 08 0696	Držátko skalpel.čepelék – kov; 15,0 cm	Scalpel handle; 15,0 cm	Metallskalpelgriff; 15,0 cm	43
112 08 0700	Utahovací klíček; 8,0 cm	Spanner; 8,0 cm	Anzugsschlüssel 8,0 cm	43
112 38 0010	Dieffenbach skalpel oční bříškátý; 1,7 cm, fig. 1	Dieffenbach knife; 1,7 cm, fig. 1	Dieffenbach Augenskalpell Fig.1	42
112 38 0020	Dieffenbach skalpel oční bříškátý; 2,0 cm, fig. 2	Dieffenbach knife; 2,0 cm, fig. 2	Dieffenbach Augenskalpell Fig.2	42
112 38 0030	Dieffenbach skalpel oční bříškátý; 2,5 cm, fig. 4	Dieffenbach knife; 2,5 cm, fig. 4	Dieffenbach Augenskalpell Fig.4	42
112 38 0040	Dieffenbach skalpel oční bříškátý; 3,0 cm, fig. 5	Dieffenbach knife; 3,0 cm, fig. 5	Dieffenbach Augenskalpell Fig.5	42
112 38 0110	Dieffenbach skalpel oční hrotnatý; 1,7 cm, fig. 7	Dieffenbach knife; 1,7 cm, fig. 7	Dieffenbach Augenskalpell Fig.7	42
112 38 0120	Dieffenbach skalpel oční hrotnatý; 2,0 cm, fig. 8	Dieffenbach knife; 2,0 cm, fig. 8	Dieffenbach Augenskalpell Fig.8	42
112 38 0130	Dieffenbach skalpel oční hrotnatý; 2,5 cm, fig. 9	Dieffenbach knife; 2,5 cm, fig. 9	Dieffenbach Augenskalpell Fig.9	42
112 38 0140	Dieffenbach skalpel oční hrotnatý; 3,0 cm, fig. 10	Dieffenbach knife; 3,0 cm, fig. 10	Dieffenbach Augenskalpell Fig.10	42
112 50 0050	Nůž na dáseň oboustranný; 18,0 cm	Gum knife mutual; 18,0 cm	Zahnfleischmesser; 18,0 cm	41
112 50 0060	Nůž na gingivektomii fig. 1; 17,3 cm	Gingivectomy knife fig. 1; 17,3 cm	Gingivektomie-Messer rechts; 17,3 cm	41
112 50 0070	Nůž na gingivektomii fig 2; 17,3 cm	Gingivectomy knife fig 2; 17,3 cm	Gingivektomie-Messer links; 17,3 cm	41
112 91 0002	Držátko skalpelových čepelék s měřítkem; fig. 3	Scalpel handle with scale fig. 3	Skalpellgriff mit Maß Nr.3	43
112 91 0003	Držátko skalpelových čepelék; fig. 3	Scalpel handle fig. 3	Skalpellgriff Nr.3	43
112 91 0004	Držátko skalpelových čepelék; fig. 4	Scalpel handle fig. 4	Skalpellgriff Nr.4	43, 125
112 91 0005	Držátko skalpelových čepelék; fig. 3l	Scalpel handle fig. 3l	Skalpellgriff Nr.3L	43
112 91 0010	Čepelka skalpelová; fig. 10 (baleno po 100 ks)	Pck=100 blades fig. 10	Pck=100 Skalpellklingen Fig.10	44
112 91 0011	Čepelka skalpelová; fig. 11 (baleno po 100 ks)	Pck=100 blades fig. 11	Pck=100 Skalpellklingen Fig.11	44
112 91 0012	Čepelka skalpelová; fig. 12 (baleno po 100 ks)	Pck=100 blades fig. 12	Pck=100 Skalpellklingen Fig.12	44
112 91 0013	Čepelka skalpelová; fig. 13 (baleno po 100 ks)	Pck=100 blades fig. 13	Pck=100 Skalpellklingen Fig.13	44
112 91 0015	Čepelka skalpelová; fig. 15 (baleno po 100 ks)	Pck=100 blades fig. 15	Pck=100 Skalpellklingen Fig.15	44
112 91 0018	Čepelka skalpelová; fig. 18 (baleno po 100 ks)	Pck=100 blades fig. 18	Pck=100 Skalpellklingen Fig.18	44
112 91 0019	Čepelka skalpelová; fig. 19 (baleno po 100 ks)	Pck=100 blades fig. 19	Pck=100 Skalpellklingen Fig.19	44
112 91 0020	Čepelka skalpelová; fig. 20 (baleno po 100 ks)	Pck=100 blades fig. 20	Pck=100 Skalpellklingen Fig.20	44
112 91 0021	Čepelka skalpelová; fig. 21 (baleno po 100 ks)	Pck=100 blades fig. 21	Pck=100 Skalpellklingen Fig.21	44
112 91 0022	Čepelka skalpelová; fig. 22 (baleno po 100 ks)	Pck=100 blades fig. 22	Pck=100 Skalpellklingen Fig.22	44
112 91 0023	Čepelka skalpelová; fig. 23 (baleno po 100 ks)	Pck=100 blades fig. 23	Pck=100 Skalpellklingen Fig.23	44
112 91 0024	Čepelka skalpelová; fig. 24 (baleno po 100 ks)	Pck=100 blades fig. 24	Pck=100 Skalpellklingen Fig.24	44
112 91 0025	Čepelka skalpelová; fig. 12d (baleno po 100 ks)	Pck=100 blades fig. 12d	Pck=100 Skalpellklingen Fig.12d	44
112 91 0026	Čepelka skalpelová; fig. 15c (baleno po 100 ks)	Pck=100 blades fig. 15c	Pck=100 Skalpellklingen Fig.15c	44
113	NŮŽKY	SCISSORS	SCHEREN	
113 05 0040	Lister nůžky na obvazy; 20,0 cm	Lister bandage scissors; 20,0 cm	Lister Verbandschere; 20,0 cm	56
113 05 0210	Nůžky na měkké obvazy; 23,5 cm	Plaster scissors; 23,5 cm	Verbandschere; 23,5 cm	56
113 08 0010	Standard nůžky chirurgické rovné; 13,0 cm	Standard operating scissors; 13,0 cm	Standard chirurgische Schere gerade; 13,0 cm	58
113 08 0020	Standard nůžky chirurgické rovné; 15,0 cm	Standard operating scissors; 15,0 cm	Standard chirurgische Schere gerade; 15,0 cm	58
113 08 0040	Standard nůžky chirurgické rovné; 18,5 cm	Standard operating scissors; 18,5 cm	Standard chirurgische Schere gerade; 18,5 cm	58
113 08 0060	Standard nůžky chirurgické rovné; 22,0 cm	Standard operating scissors; 22,0 cm	Standard chirurgische Schere gerade; 22,0 cm	58
113 08 0070	Standard nůžky chirurgické rovné; 30,0 cm	Standard operating scissors; 30,0 cm	Standard chirurgische Schere gerade; 30,0 cm	58
113 08 0110	Standard nůžky chirurgické rovné; 13,0 cm	Standard operating scissors; 13,0 cm	Standard chirurgische Schere gerade; 13,0 cm	58
113 08 0120	Standard nůžky chirurgické rovné; 15,0 cm	Standard operating scissors; 15,0 cm	Standard chirurgische Schere gerade; 15,0 cm	58
113 08 0140	Standard nůžky chirurgické rovné; 18,5 cm	Standard operating scissors; 18,5 cm	Standard chirurgische Schere gerade; 18,5 cm	58
113 08 0160	Standard nůžky chirurgické rovné; 22,0 cm	Standard operating scissors; 22,0 cm	Standard chirurgische Schere gerade; 22,0 cm	58
113 08 0170	Standard nůžky chirurgické rovné; 30,0 cm	Standard operating scissors; 30,0 cm	Standard chirurgische Schere gerade; 30,0 cm	58
113 08 0210	Standard nůžky chirurgické rovné; 13,0 cm	Standard operating scissors; 13,0 cm	Standard chirurgische Schere gerade; 13,0 cm	59
113 08 0220	Standard nůžky chirurgické rovné; 15,0 cm	Standard operating scissors; 15,0 cm	Standard chirurgische Schere gerade; 15,0 cm	59
113 08 0240	Standard nůžky chirurgické rovné; 18,5 cm	Standard operating scissors; 18,5 cm	Standard chirurgische Schere gerade; 18,5 cm	59
113 08 0260	Standard nůžky chirurgické rovné; 22,0 cm	Standard operating scissors; 22,0 cm	Standard chirurgische Schere gerade; 22,0 cm	59
113 08 0270	Standard nůžky chirurgické rovné; 30,0 cm	Standard operating scissors; 30,0 cm	Standard chirurgische Schere gerade; 30,0 cm	59
113 08 0310	Standard nůžky chirurgické zahnuté; 13,0 cm	Standard operating scissors; 13,0 cm	Standard chirurgische Schere gebogen; 13,0 cm	58
113 08 0320	Standard nůžky chirurgické zahnuté; 15,0 cm	Standard operating scissors; 15,0 cm	Standard chirurgische Schere gebogen; 15,0 cm	58
113 08 0340	Standard nůžky chirurgické zahnuté; 18,5 cm	Standard operating scissors; 18,5 cm	Standard chirurgische Schere gebogen; 18,5 cm	58
113 08 0360	Standard nůžky chirurgické zahnuté; 22,0 cm	Standard operating scissors; 22,0 cm	Standard chirurgische Schere gebogen; 22,0 cm	58
113 08 0370	Standard nůžky chirurgické zahnuté; 30,0 cm	Standard operating scissors; 30,0 cm	Standard chirurgische Schere gebogen; 30,0 cm	58
113 08 0410	Standard nůžky chirurgické zahnuté; 13,0 cm	Standard operating scissors; 13,0 cm	Standard chirurgische Schere gebogen; 13,0 cm	58
113 08 0420	Standard nůžky chirurgické zahnuté; 15,0 cm	Standard operating scissors; 15,0 cm	Standard chirurgische Schere gebogen; 15,0 cm	58
113 08 0440	Standard nůžky chirurgické zahnuté; 18,5 cm	Standard operating scissors; 18,5 cm	Standard chirurgische Schere gebogen; 18,5 cm	58
113 08 0460	Standard nůžky chirurgické zahnuté; 22,0 cm	Standard operating scissors; 22,0 cm	Standard chirurgische Schere gebogen; 22,0 cm	58
113 08 0470	Standard nůžky chirurgické zahnuté; 30,0 cm	Standard operating scissors; 30,0 cm	Standard chirurgische Schere gebogen; 30,0 cm	58
113 08 0510	Standard nůžky chirurgické zahnuté; 13,0 cm	Standard operating scissors; 13,0 cm	Standard chirurgische Schere gebogen; 13,0 cm	59
113 08 0520	Standard nůžky chirurgické zahnuté; 15,0 cm	Standard operating scissors; 15,0 cm	Standard chirurgische Schere gebogen; 15,0 cm	59
113 08 0540	Standard nůžky chirurgické zahnuté; 18,5 cm	Standard operating scissors; 18,5 cm	Standard chirurgische Schere gebogen; 18,5 cm	59
113 08 0560	Standard nůžky chirurgické zahnuté; 22,0 cm	Standard operating scissors; 22,0 cm	Standard chirurgische Schere gebogen; 22,0 cm	59
113 08 0570	Standard nůžky chirurgické zahnuté; 30,0 cm	Standard operating scissors; 30,0 cm	Standard chirurgische Schere gebogen; 30,0 cm	59
113 38 0010	Nůžky rovné; 10,0 cm	Scissors; 10,0 cm	Augenschere gerade; 10,0 cm	60
113 38 0020	Nůžky rovné; 10,0 cm	Scissors; 10,0 cm	Augenschere gerade; 10,0 cm	60
113 38 0030	Nůžky rovné; 10,0 cm	Scissors; 10,0 cm	Augenschere gerade; 10,0 cm	60
113 38 0040	Nůžky zahnuté; 10,0 cm	Scissors; 10,0 cm	Augenschere gebogen; 10,0 cm	60
113 38 0050	Nůžky zahnuté; 10,0 cm	Scissors; 10,0 cm	Augenschere gebogen; 10,0 cm	60
113 38 0060	Nůžky zahnuté; 10,0 cm	Scissors; 10,0 cm	Augenschere gebogen; 10,0 cm	60
113 38 0071	Nůžky rovné; 11,5 cm	Scissors; 11,5 cm	Augenschere gerade; 11,5 cm	60
113 38 0081	Nůžky rovné; 11,5 cm	Scissors; 11,5 cm	Augenschere gerade; 11,5 cm	60

číslo – number	název	item	Artikel	strana – page
113 38 0091	Nůžky zahnuté; 11,5 cm	Scissors; 11,5 cm	Augenschere gebogen; 11,5 cm	60
113 38 0100	Nůžky zahnuté; 11,5 cm	Scissors; 11,5 cm	Augenschere gebogen; 11,5 cm	60
113 38 0150	Nůžky rovné; 11,5 cm	Scissors; 11,5 cm	Augenschere gerade; 11,5 cm	60
113 38 0161	Nůžky zahnuté; 11,5 cm	Scissors; 11,5 cm	Augenschere gebogen; 11,5 cm	60
113 38 0210	Nůžky lomené; 10,5 cm	Scissors; 10,5 cm	Augenschere gebogen spitzig; 10,5 cm	60
113 38 0260	Nůžky lomené; 10,5 cm	Scissors; 10,5 cm	Augenschere gebogen stumpf; 10,5 cm	60
113 38 0311	Nůžky; 11,5 cm	Scissors; 11,5 cm	Augenschere gebogen spitzig; 11,5 cm	60
113 38 1020	Castroviejo nůžky oční zahnuté; 9,0 cm	Castroviejo eye scissors; 9,0 cm	Castroviejo Mikro-federschere, geb.; 9,0 cm	61
113 38 1030	Castroviejo nůžky oční lomené; 9,0 cm	Castroviejo eye scissors; 9,0 cm	Castroviejo Mikro-federschere, geb.; 9,0 cm	61
113 50 0010	Nůžky na dásně rovné; 12,0 cm	Gum scissors; 12,0 cm	Zahnfleischschere gerade; 12,0 cm	57
113 50 0020	Nůžky na dásně zahnuté; 12,0 cm	Gum scissors; 12,0 cm	Zahnfleischschere gebogen; 12,0 cm	57
113 50 0030	Nůžky na dásně rovné; 14,5 cm	Gum scissors; 14,5 cm	Zahnfleischschere gerade; 14,5 cm	57
113 50 0040	Nůžky na dásně zahnuté; 14,5 cm	Gum scissors; 14,5 cm	Zahnfleischschere gebogen; 14,5 cm	57
113 52 0150	Nůžky na korunky rovné; 11,0 cm	Crown scissors; 11,0 cm	Kronenschere gerade; 11,0 cm	120
113 52 0160	Nůžky na korunky zahnuté; 11,0 cm	Crown scissors; 11,0 cm	Kronenschere gebogen; 10,9 cm	120
113 91 0002	Standard nůžky chirurgické rovné; 11,5 cm	Standard operating scissors; 11,5 cm	Standard Schere gerade st/st; 11,5 cm	59
113 91 0006	Standard nůžky chirurgické rovné; 16,5 cm	Standard operating scissors; 16,5 cm	Standard Schere gerade st/st; 16,5 cm	59
113 91 0009	Standard nůžky chirurgické rovné; 20,0 cm	Standard operating scissors; 20,0 cm	Standard Schere gerade st/st; 20,0 cm	59
113 91 0011	Standard nůžky chirurgické zahnuté; 11,5 cm	Standard operating scissors; 11,5 cm	Standard Schere gebogen st/st; 11,5 cm	59
113 91 0015	Standard nůžky chirurgické zahnuté; 16,5 cm	Standard operating scissors; 16,5 cm	Standard Schere gebogen st/st; 16,5 cm	59
113 91 0018	Standard nůžky chirurgické zahnuté; 20,0 cm	Standard operating scissors; 20,0 cm	Standard Schere gebogen st/st; 20,0 cm	59
113 91 0020	Nůžky chirurgické rovné; 11,5 cm	Operating scissors; 11,5 cm	Standard Schere gerade sp/st; 11,5 cm	58
113 91 0026	Nůžky chirurgické rovné; 16,5 cm	Operating scissors; 16,5 cm	Standard Schere gerade sp/st; 16,5 cm	58
113 91 0029	Nůžky chirurgické rovné; 20,0 cm	Operating scissors; 20,0 cm	Standard Schere gerade sp/st; 20,0 cm	58
113 91 0031	Nůžky chirurgické zahnuté; 11,5 cm	Operating scissors; 11,5 cm	Standard Schere gebogen sp/st; 11,5 cm	58
113 91 0037	Nůžky chirurgické zahnuté; 16,5 cm	Operating scissors; 16,5 cm	Standard Schere gebogen sp/st; 16,5 cm	58
113 91 0040	Nůžky chirurgické zahnuté; 20,0 cm	Operating scissors; 20,0 cm	Standard Schere gebogen sp/st; 20,0 cm	58
113 91 0042	Nůžky chirurgické rovné; 11,5 cm	Operating scissors; 11,5 cm	Standard Schere gerade sp/sp; 11,5 cm	58
113 91 0046	Nůžky chirurgické rovné; 16,5 cm	Operating scissors; 16,5 cm	Standard Schere gerade sp/sp; 16,5 cm	58
113 91 0049	Nůžky chirurgické rovné; 20,0 cm	Operating scissors; 20,0 cm	Standard Schere gerade sp/sp; 20,0 cm	58
113 91 0051	Nůžky chirurgické zahnuté; 11,5 cm	Operating scissors; 11,5 cm	Standard Schere gebogen sp/sp; 11,5 cm	58
113 91 0055	Nůžky chirurgické zahnuté; 16,5 cm	Operating scissors; 16,5 cm	Standard Schere gebogen sp/sp; 16,5 cm	58
113 91 0058	Nůžky chirurgické zahnuté; 20,0 cm	Operating scissors; 20,0 cm	Standard Schere gebogen sp/sp; 20,0 cm	58
113 91 0221	Sanvenero nůžky preparační hrotnaté rovné; 14,0 cm	Sanvenero dissecting scissors; 14,0 cm	Sanvenero Praeparierschere gerade sp/sp; 14,0 cm	59
113 91 0222	Sanvenero nůžky preparační hrotnaté zahnuté; 14,0 cm	Sanvenero dissecting scissors; 14,0 cm	Sanvenero Praeparierschere gebogen sp/sp; 14,0 cm	59
113 91 0233	Reynolds nůžky preparační ostré rovné; 15,0 cm	Reynolds dissecting scissors; 15,0 cm	Reynolds Praeparierschere gerade sp.; 15,0 cm	59
113 91 0235	Reynolds nůžky preparační ostré zahnuté; 15,0 cm	Reynolds dissecting scissors; 15,0 cm	Reynolds Praeparierschere gebogen sp.; 15,0 cm	59
113 91 0474	Goldman-Fox nůžky na dásně rovné; 13,0 cm	Goldman-Fox scissors; 13,0 cm	Goldman-Fox Schere gerade; 13,0 cm	57
113 91 0475	Goldman-Fox nůžky na dásně zahnuté; 13,0 cm	Goldman-Fox scissors; 13,0 cm	Goldman-Fox Schere gebogen; 13,0 cm	57
113 91 0483	Quinby nůžky na dásně rovné; 12,0 cm	Quinby gum scissors; 12,0 cm	Quinby Zahnfleischschere gerade; 12,0 cm	57
113 91 0484	Quinby nůžky na dásně zahnuté; 12,0 cm	Quinby gum scissors; 12,0 cm	Quinby Zahnfleischschere gebogen; 12,5 cm	57
113 91 0490	Noyes nůžky na duhovku hrotnaté rovné; 12,0 cm	Noyes iris scissors; 12,0 cm	Noyes Iridektomieschere ger.sp/sp; 12,0 cm	61
113 91 0492	Noyes nůžky na duhovku hrotnatutupé rovné; 12,0 cm	Noyes iris scissors; 12,0 cm	Noyes Iridektomieschere ger.sp/st.; 12,0 cm	61
113 91 0494	Noyes nůžky na duhovku tupé rovné; 12,0 cm	Noyes iris scissors; 12,0 cm	Noyes Iridektomieschere ger.st/st; 12,0 cm	61
113 91 0503	Castroviejo nůžky na duhovku tupé rovné; 9,0 cm	Castroviejo iris scissors; 9,0 cm	Castroviejo Iridektomieschere ger.st/st; 9,0 cm	61
113 91 0505	Castroviejo nůžky na duhovku tupé lomené; 9,0 cm	Castroviejo iris scissors; 9,0 cm	Castroviejo Iridektomieschere abgew.st/st; 9,0 cm	61
113 91 0507	Castroviejo nůžky na duhovku hrotnaté; 10,0 cm	Castroviejo iris scissors; 10,0 cm	Castroviejo Iridektomieschere sp.; 10,0 cm	61
113 91 0508	Castroviejo nůžky na duhovku tupé; 10,0 cm	Castroviejo iris scissors; 10,0 cm	Castroviejo Iridektomieschere st.; 10,0 cm	61
113 91 0537	Gomel nůžky mikro tupé; 14,5 cm	Gomel dissection micro scissors; 14,5 cm	Gomel Mikro-schere st/st; 14,5 cm	62
113 91 0538	Gomel nůžky mikro tupé; 18,0 cm	Gomel dissection micro scissors; 18,0 cm	Gomel Mikro-schere st/st; 18,0 cm	62
113 91 0539	Gomel nůžky mikro hrotnaté; 14,5 cm	Gomel dissection micro scissors; 14,5 cm	Gomel Mikro-schere sp/sp; 14,5 cm	62
113 91 0540	Gomel nůžky mikro hrotnaté; 18,0 cm	Gomel dissection micro scissors; 18,0 cm	Gomel Mikro-schere sp/sp; 18,0 cm	62
113 91 0552	Nůžky mikro; rovné 18,5 cm	Dissection micro scissors; straight 18,5 cm	Mikroschere gerade; 18,5 cm	62
113 91 0553	Nůžky mikro; zahnuté 18,5 cm	Dissection micro scissors; curved 18,5 cm	Mikroschere gebogen; 18,5 cm	62
114	PINZETY	FORCEPS	PINZETTEN	
114 08 0030	Standard pinzeta anatomická; 16,0 cm	Tissue forceps; 16,0 cm	Anatomische Pinzette; 16,0 cm	65
114 08 0040	Standard pinzeta anatomická; 20,0 cm	Tissue forceps; 20,0 cm	Anatomische Pinzette; 20,0 cm	65
114 08 0050	Standard pinzeta anatomická; 25,0 cm	Tissue forceps; 25,0 cm	Anatomische Pinzette; 15,0 cm	65
114 08 0060	Standard pinzeta anatomická; 30,0 cm	Tissue forceps; 30,0 cm	Anatomische Pinzette; 30,0 cm	65
114 08 0090	Pinzeta anatomická rovná jemná matovaná; 14,5 cm	Tissue forceps; 14,5 cm	Anatomische Pinzette glatt gerade; 14,5 cm	64
114 08 0101	Pinzeta anatomická jemná; 14,5 cm	Tissue forceps; 14,5 cm	Anatomische Pinzette fein mattiert gerade; 14,5 cm	64, 125
114 08 0140	Pinzeta anatomická jemná; 20,0 cm	Tissue forceps; 20,0 cm	Anatomische Pinzette fein; 20,0 cm	64
114 08 0231	Pinzeta anatomická velmi jemná; 14,5 cm	Tissue forceps; 14,5 cm	Anatomische Pinzette sehr fein mattiert; 14,5 cm	64
114 08 0240	Pinzeta anatomická velmi jemná; 20,0 cm	Tissue forceps; 20,0 cm	Anatomische Pinzette sehr fein; 20,0 cm	64
114 08 0250	Pinzeta anatomická velmi jemná; 24,5 cm	Tissue forceps; 24,5 cm	Anatomische Pinzette sehr fein; 20,0 cm	64
114 08 0340	Standard pinzeta chirurgická; 20,0 cm	Dressing forceps; 20,0 cm	Chirurgische Pinzette; 16,0 cm	65
114 08 0350	Standard pinzeta chirurgická; 25,0 cm	Dressing forceps; 25,0 cm	Chirurgische Pinzette; 20,0 cm	65
114 08 0360	Standard pinzeta chirurgická; 30,0 cm	Dressing forceps; 30,0 cm	Chirurgische Pinzette; 25,0 cm	65
114 08 0381	Standard pinzeta chirurgická; 14,5 cm	Dressing forceps; 14,5 cm	Chirurgische Pinzette mattiert; 14,5 cm	65
114 08 0430	Standard pinzeta chirurgická jemná; 16,0 cm	Dressing forceps; 16,0 cm	Chirurgische Pinzette fein; 30,0 cm	65
114 38 0010	Graefe pinzeta oční rovná; 10,5 cm	Graefe eye forceps; 10,5 cm	Graefe Irispinzette gerade; 10,5 cm	67
114 38 0020	Graefe pinzeta oční rovná jemná; 10,5 cm	Graefe eye forceps; 10,5 cm	Graefe Irispinzette fein gerade; 10,5 cm	67
114 38 0100	Graefe pinzeta oční zahnutá jemná; 10,5 cm	Graefe eye forceps; 10,5 cm	Graefe Irispinzette fein gebogen; 10,5 cm	67
114 38 0150	Graefe pinzeta oční rovná; 1×2 zuby; 10,5 cm	Graefe eye forceps; 1×2 teeth; 10,5 cm	Graefe Irispinzette gerade; 1×2 Zähne; 10,5 cm	67
114 38 0160	Graefe pinzeta oční rovná jemná; 1×2 zuby; 10,5 cm	Graefe eye forceps; 1×2 teeth; 10,5 cm	Graefe Irispinzette gerade sehr fein; 1×2 Zähne; 10,5 cm	67
114 38 0360	Graefe pinzeta fixační s uzávěrem s perem; 11,0 cm	Graefe fixation forceps; 11,0 cm	Graefe Fixierpinzette mit schloss; 11,0 cm	67
114 50 0011	Pinzeta zubní s rýhov. čelistí zahnutá; 15,7 cm	Dental forceps curved; 15,7 cm	Zahnpinzette gerieft; 15,7 cm	63, 74, 122
114 50 0021	Pinzeta zubní s rýhov. čelistí lomená; 15,7 cm	Dental forceps angled; 15,7 cm	Zahnpinzette gerieft; 15,7 cm	63
114 50 0031	Pinzeta zubní s hladkou čelistí lomená; 15,7 cm	Dental forceps angled; 15,7 cm	Zahnpinzette glatt; 15,7 cm	63
114 50 0051	Pinzeta na kořenové čípky; 15,7 cm	Root suppository forceps; 15,7 cm	Zahnpinzette für Wurzelstifte; 15,7 cm	63
114 50 0150	Pinzeta zubní chirurgická zahnutá jemná; 14,2 cm	Dental forceps; 14,2 cm	Zahnpinzette; 14,2 cm	63

číslo – number	název	item	Artikel	strana – page
114 50 0170	Pinzeta zubní chirurgická zahnutá; 15,7 cm	Dental forceps; 15,7 cm	Zahnpinzette 15,7 cm	63
114 50 1030	Pinzeta zubní lomená Dia; 15,7 cm	Dental forceps Dia; 15,7 cm	Zahnpinzette; dia; 15,7 cm	63
114 52 0020	Pinzeta laboratorní hrotnatá; 12,5 cm	Laboratory forceps; 12,5 cm	Laborpinzette; 12,5 cm	68, 119
114 52 0030	Pinzeta laboratorní; 0,3 mm; 12,5 cm	Laboratory forceps; 0,3 mm; 12,5 cm	Laborpinzette; 0,3 mm; 12,5 cm	68, 119
114 52 0040	Pinzeta laboratorní; 0,4 mm; 12,5 cm	Laboratory forceps; 0,4 mm; 12,5 cm	Laborpinzette; 0,4 mm; 12,5 cm	68, 119
114 52 0050	Pinzeta laboratorní; 0,3 mm; 11,0 cm	Laboratory forceps; 0,3 mm; 11,0 cm	Laborpinzette; 0,3 mm; 11,0 cm	68, 119
114 52 0060	Pinzeta laboratorní; 0,4 mm; 11,0 cm	Laboratory forceps; 0,4 mm; 11,0 cm	Laborpinzette; 0,4 mm; 11,0 cm	68, 119
114 52 0100	Pinzeta zkřížená; 15,3 cm	Cross-action forceps; 15,3 cm	Pinzette gekreuzt; 15,3 cm	68, 119
114 52 0101	Pinzeta zkřížená; 15,3 cm	Cross-action forceps; 15,3 cm	Pinzette gekreuzt 15,3 cm	68, 119
114 52 0110	Pinzeta zkřížená se šroubovákem; 15,5 cm	Cross-action forceps with screwdriver; 15,5 cm	Pinzette gekreuzt mit Schraubenzieher; 15,5 cm	68, 119
114 91 0002	Standard pinzeta chirurgická; 11,5 cm	Dressing forceps; 11,5 cm	Anatomische Pinzette gerade; 11,5 cm	65
114 91 0003	Standard pinzeta chirurgická; 13,0 cm	Dressing forceps; 13,0 cm	Anatomische Pinzette gerade; 13,0 cm	65
114 91 0004	Standard pinzeta chirurgická; 14,5 cm	Dressing forceps; 14,5 cm	Anatomische Pinzette gerade; 14,5 cm	65
114 91 0006	Standard pinzeta chirurgická; 18,0 cm	Dressing forceps; 18,0 cm	Anatomische Pinzette gerade; 18,0 cm	65
114 91 0011	Standard pinzeta chirurgická; 11,5 cm	Dressing forceps; 11,5 cm	Chirurgische Pinzette gerade 1×2 Zähne; 11,5 cm	65
114 91 0012	Standard pinzeta chirurgická; 13,0 cm	Dressing forceps; 13,0 cm	Chirurgische Pinzette gerade 1×2 Zähne; 13,0 cm	65
114 91 0015	Standard pinzeta chirurgická; 18,0 cm	Dressing forceps; 18,0 cm	Chirurgische Pinzette gerade 1×2 Zähne; 18,0 cm	65
114 91 0477	Oehler pinzeta chirurgická tvrdokov; 1×2 zuby; 14,0 cm	Oehler tissue forceps TUC; 1×2 teeth; 14,0 cm	Oehler Hakenpinzette TUC 1×2 Zähne; 14,0 cm	66
114 91 0478	Oehler pinzeta chirurgická tvrdokov; 1×2 zuby; 16,0 cm	Oehler tissue forceps TUC; 1×2 teeth; 16,0 cm	Oehler Hakenpinzette TUC 1×2 Zähne; 16,0 cm	66
114 91 0479	Oehler pinzeta chirurgická tvrdokov; 1×2 zuby; 18,0 cm	Oehler tissue forceps TUC; 1×2 teeth; 18,0 cm	Oehler Hakenpinzette TUC 1×2 Zähne; 18,0 cm	66
114 91 0480	Oehler pinzeta chirurgická tvrdokov; 1×2 zuby; 20,0 cm	Oehler tissue forceps TUC; 1×2 teeth; 20,0 cm	Oehler Hakenpinzette TUC 1×2 Zähne; 20,0 cm	66
114 91 0481	Oehler pinzeta chirurgická tvrdokov; 1×2 zuby; 25,0 cm	Oehler tissue forceps TUC; 1×2 teeth; 25,0 cm	Oehler Hakenpinzette TUC 1×2 Zähne; 25,0 cm	66
114 91 0482	Oehler pinzeta chirurgická tvrdokov; 1×2 zuby; 30,0 cm	Oehler tissue forceps TUC; 1×2 teeth; 30,0 cm	Oehler Hakenpinzette TUC 1×2 Zähne; 30,0 cm	66
114 91 0483	Semken pinzeta anatomická tvrdokov; 12,5 cm	Semken dissecting forceps TUC; 12,5 cm	Semken Pinzette TUC; 12,5 cm	66
114 91 0484	Semken pinzeta anatomická tvrdokov; 15,5 cm	Semken dissecting forceps TUC; 15,5 cm	Semken Pinzette TUC; 15,5 cm	66
114 91 0485	Gillies pinzeta chirurgická tvrdokov; 1×2 zuby; 15,0 cm	Gillies tissue forceps TUC; 1×2 teeth; 15,0 cm	Gillies Chirurg. Pinzette 1×2 TUC; 15,0cm	66
114 91 0486	Jeweler pinzeta tvrdokov; 15,0 cm	Jeweler forceps TUC; 15,0 cm	Jeweler Pinzette TUC; 15,0 cm	66
114 91 0487	Adson pinzeta anatomická tvrdokov; 12,0 cm	Adson forceps TUC; 12,0 cm	Adson Pinzette TUC; 12,0 cm	66
114 91 0489	Adson pinzeta anatomická tvrdokov; 15,0 cm	Adson forceps TUC; 15,0 cm	Adson Pinzette TUC; 15,0 cm	66
114 91 0490	Adson pinzeta chirurgická tvrdokov; 1×2 zuby; 12,0 cm	Adson forceps TUC; 1×2 teeth; 12,0 cm	Adson Pinzette TUC 1×2 Zähne; 12,0 cm	66
114 91 0491	Adson pinzeta chirurgická tvrdokov; 1×2 zuby; 15,0 cm	Adson forceps TUC; 1×2 teeth; 15,0 cm	Adson Pinzette TUC 1×2 Zähne; 15,0 cm	66
115	SVORKY	CLAMPS, FORCEPS	KLEMMEN	
115 08 0010	Mosquito-Halsted svorka na cévy rovná; 12,0 cm	Mosquito-Halsted artery forceps; 12,0 cm	Mosquito-Halsted Arterienklemme gerade; 12,0 cm	45, 125
115 08 0020	Mosquito-Halsted svorka na cévy zahnutá; 12,0 cm	Mosquito-Halsted artery forceps; 12,0 cm	Mosquito-Halsted Arterienklemme gebogen; 12,0 cm	45, 122
115 08 0030	Mosquito-Halsted svorka na cévy rovná; 12,0 cm	Mosquito-Halsted artery forceps; 12,0 cm	Mosquito-Halsted Arterienklemme gerade; 12,0 cm	45
115 08 0040	Mosquito-Halsted svorka na cévy rovná; 12,0 cm	Mosquito-Halsted artery forceps; 12,0 cm	Mosquito-Halsted Arterienklemme gerade; 12,0 cm	45
115 08 0050	Mosquito-Halsted svorka na cévy zahnutá; 12,0 cm	Mosquito-Halsted artery forceps; 12,0 cm	Mosquito-Halsted Arterienklemme gebogen; 12,0 cm	45
115 08 0060	Mosquito-Halsted svorka na cévy zahnutá; 12,0 cm	Mosquito-Halsted artery forceps; 12,0 cm	Mosquito-Halsted Arterienklemme gebogen; 12,0 cm	45
115 08 0260	Rochester-Pean svorka na cévy zahnutá; 14,0 cm	Rochester-Pean artery forceps; 14,0 cm	Rochester-Pean Arterienklemme gebogen; 14,0 cm	47
115 08 0500	Kelly svorka na cévy zahnutá; 14,0 cm	Kelly artery forceps; 14,0 cm	Kelly Arterienklemme gebogen; 14,0 cm	47
115 08 0780	Backhaus svorka na prádlo; 11,8 cm	Backhaus towel forceps; 11,8 cm	Backhaus Tuchklemme; 11,8 cm	48
115 08 0790	Backhaus svorka na prádlo; 12,0 cm	Backhaus towel forceps; 12,0 cm	Backhaus Papierklemme; 12,0 cm	48
115 08 0810	Backhaus svorka na prádlo; 8,0 cm	Backhaus towel forceps; 8,0 cm	Backhaus Tuchklemme; 8,0 cm	48
115 08 0820	Backhaus svorka na prádlo; 13,0 cm	Backhaus towel forceps; 13,0 cm	Backhaus Tuchklemme; 13,0 cm	48
115 08 1010	Mosquito-Halsted svorka na cévy rovná; 12,0 cm	Mosquito-Halsted artery forceps; 12,0 cm	Mosquito-Halsted Arterienklemme fein gerade; 12,0 cm;	45
115 08 1020	Mosquito-Halsted svorka na cévy zahnutá; 12,0 cm	Mosquito-Halsted artery forceps; 12,0 cm	Mosquito-Halsted Arterienklemme fein gebogen; 12,0 cm	45
115 08 1030	Mosquito-Halsted svorka na cévy rovná; 12,0 cm	Mosquito-Halsted artery forceps; 12,0 cm	Mosquito-Halsted Arterienklemme fein gerade; 12,0 cm;	45
115 08 1050	Mosquito-Halsted svorka na cévy zahnutá; 12,0 cm	Mosquito-Halsted artery forceps; 12,0 cm	Mosquito-Halsted Arterienklemme fein gebogen; 12,0 cm	45
115 91 0068	Hartmann svorka rovná; 10,0 cm	Hartmann forceps; 10,0 cm	Hartmann arterienklemme gerade; 10,0 cm	46
115 91 0069	Hartmann svorka zahnutá; 10,0 cm	Hartmann forceps; 10,0 cm	Hartmann arterienklemme gebogen; 10,0 cm	46
115 91 0073	Micro-Mosquito svorka na cévy rovná; 12,0 cm	Micro-Mosquito artery forceps; 12,0 cm	Micro-Mosquito Arterienklemme gerade; 12,0 cm	46
115 91 0075	Micro-Mosquito svorka na cévy zahnutá; 12,0 cm	Micro-Mosquito artery forceps; 12,0 cm	Micro-Mosquito Arterienklemme gebogen; 12,0 cm	46
115 91 0077	Micro-Mosquito svorka rovná 1×2 zuby; 12,0 cm	Micro-Mosquito artery forceps; 1×2 teeth; 12,0 cm	Micro-Mosquito Arterienklemme gerade 1×2 z.; 12,0 cm	46
115 91 0079	Micro-Mosquito svorka zahnutá 1×2 zuby; 12,0 cm	Micro-Mosquito artery forceps; 1×2 teeth; 12,0 cm	Micro-Mosquito Arterienklemme gebogen 1×2 z.; 12,0 cm	46
115 91 0080	Halsted-Mosquito svorka na cévy rovná; 12,5 cm	Halsted-Mosquito artery forceps straight; 12,5 cm	Halsted-Mosquito Arterienklemme gerade; 12,5 cm	46
115 91 0082	Halsted-Mosquito svorka na cévy zahnutá; 12,5 cm	Halsted-Mosquito artery forceps curved; 12,5 cm	Halsted-Mosquito Arterienklemme gebogen; 12,5 cm	46
115 91 0084	Halsted-Mosquito svorka; 1×2 zuby rovná; 12,5 cm	Halsted-Mosquito artery forceps straight; 1×2 teeth; 12,5 cm	Halsted-Mosquito Arterienklemme 1×2 gerade; 12,5 cm	46
115 91 0086	Halsted-Mosquito svorka zahnutá; 1×2 zuby; 12,5 cm	Halsted-Mosquito artery forceps curved; 1×2 teeth; 12,5 cm	Halsted-Mosquito Arterienklemme 1×2 gebogen; 12,5 cm	46
115 91 0341	Backhaus-Clip svorka na prádlo; 11,0 cm	Backhaus-Clip towel forceps; 11,0 cm	Tuchklemme mit Schlauchhalter; 11,0 cm	48
115 91 0343	Backhaus svorka na prádlo; 11,0 cm	Backhaus towel forceps; 11,0 cm	Backhaus Tuchklemme; 11,0 cm	48
115 91 0345	Backhaus svorka na prádlo; 15,0 cm	Backhaus towel forceps; 15,0 cm	Backhaus Tuchklemme; 15,0 cm	48
115 91 0348	Roeder svorka na prádlo; 13,0 cm	Roeder towel forceps; 13,0 cm	Roeder Tuchklemme; 13,0 cm	49
115 91 0349	Roeder svorka na prádlo; 15,0 cm	Roeder towel forceps; 15,0 cm	Roeder Tuchklemme; 15,0 cm	49
115 91 0350	Lorna svorka na prádlo; 10,0 cm	Lorna towel forceps; 10,0 cm	Lorna Tuchklemme; 10,0 cm	49
115 91 0351	Lorna svorka na prádlo; 13,0 cm	Lorna towel forceps; 13,0 cm	Lorna Tuchklemme; 13,0 cm	49
115 91 0352	Tohoku-Japan svorka na prádlo; 10,0 cm	Tohoku-Japan towel forceps; 10,0 cm	Tohoku-Japan Tuchklemme; 10,0 cm	49
115 91 0353	Tohoku-Japan svorka na prádlo; 13,0 cm	Tohoku-Japan towel forceps; 13,0 cm	Tohoku-Japan Tuchklemme; 13,0 cm	49
115 91 0354	Peers svorka na prádlo; 10,0 cm	Peers towel forceps; 10,0 cm	Peers Tuchklemme; 14,5 cm	49
115 91 0382	Babcock svorka chirurgická; 16,0 cm	Babcock tissue seizing forceps; 16,0 cm	Babcock Darmfasszange; 16,0 cm	47
116	KLEŠTĚ ŠTÍPACÍ	BONE RONGEURS	HOHLMEISSELZANGEN	
116 08 0030	Luer kleště štípací na kosti rovné; 17,0 cm	Luer bone rongeurs; 17,0 cm	Luer Hohlmeißelzange gerade; 17,0 cm	17
116 08 0070	Luer kleště štípací na kosti silně zahnuté; 15,0 cm	Luer bone rongeurs; 15,0 cm	Luer Hohlmeißelzange gebogen; 15,0 cm	17
116 08 0080	Luer kleště štípací na kosti zahnuté; 14,5 cm	Luer bone rongeurs; 14,5 cm	Luer Hohlmeißelzange gebogen; 14,5 cm	17
116 08 0280	Kleště štípací; 14,0 cm	Bone rongeurs; 14,0 cm	Hohlmeißelzange gerade; 14,0 cm	18
116 08 0410	Liston kleště štípací rovné; 14,0 cm	Liston bone rongeurs; 14,0 cm	Liston Hohlmeißelzange gerade; 14,0 cm	18
116 08 0440	Liston kleště štípací rovné; 19,0 cm	Liston bone rongeurs; 19,0 cm	Liston Hohlmeißelzange gerade; 19,0 cm	18
116 08 0450	Liston kleště štípací zahnuté; 19,0 cm	Liston bone rongeurs; 19,0 cm	Liston Hohlmeißelzange gebogen; 19,0 cm	18
116 29 0410	Jansen kleště štípací fig. 2; 18,0 cm	Jansen mastoid forceps fig. 2; 18,0 cm	Jansen Ohrkniefzange gebogen Fig.2; 18,0 cm	17
116 91 0001	Kleště štípací na drát; 14,5 cm	Wire cutting forceps; 14,5 cm	Drahtkniefzange; 14,5 cm	113
116 91 0017	Mini-Friedman kleště štípací na kosti; 12,0 cm	Mini-Friedman bone rongeurs; 12,0 cm	Mini-Friedman Knochenkniefzange; 12,0 cm	16
116 91 0514	Friedman kleště štípací na kosti; 14,0 cm	Friedman bone rongeurs; 14,0 cm	Friedman Knochenkniefzange; 14,0 cm	16

číslo – number	název	item	Artikel	strana – page
116 91 0515	Stellbrink kleště štípací na kosti; 17,0 cm	Stellbrink bone ronguers; 17,0 cm	Stellbrink Knochenkniefzange; 17,0 cm	16
116 91 0516	Stellbrink kleště štípací na kosti; 17,0 cm	Stellbrink bone ronguers; 17,0 cm	Stellbrink Knochenkniefzange; 17,0 cm	16
116 91 0518	Cleveland kleště štípací na kosti; 17,0 cm	Cleveland bone ronguers; 17,0 cm	Cleveland Knochenkniefzange; 17,0 cm	16
116 91 0522	Blumenthal kleště štípací na kosti; 15,5 cm	Blumenthal bone ronguers; 15,5 cm	Blumenthal Knochenkniefzange; 15,5 cm	16
116 91 0523	Blumenthal kleště štípací na kosti; 15,5 cm	Blumenthal bone ronguers; 15,5 cm	Blumenthal Knochenkniefzange; 15,5 cm	16
116 91 0524	Blumenthal kleště štípací na kosti; 15,5 cm	Blumenthal bone ronguers; 15,5 cm	Blumenthal Knochenkniefzange; 15,5 cm	16
116 91 0527	Luer kleště štípací na kosti; 15,0 cm	Luer bone ronguers; 15,0 cm	Luer Knochenkniefzange; 15,0 cm	16
116 91 0528	Luer kleště štípací na kosti; 15,0 cm	Luer bone ronguers; 15,0 cm	Luer Knochenkniefzange; 15,0 cm	16
116 91 0529	Luer kleště štípací na kosti; 15,0 cm	Luer bone ronguers; 15,0 cm	Luer Knochenkniefzange; 15,0 cm	16
117	KLEŠTĚ ÚCHOPNÉ, EXTRAKČNÍ	GRASPING FORCEPS, EXTRACTION FORCEPS	HALTERZANGEN, ZAHNZANGEN	
117 31 0010	Collin kleště na jazyk okénkové; 16,7 cm	Collin tongue holding forceps; 16,7 cm	Collin Zungenhalterzange; 16,7 cm	19
117 31 0030	Löbker kleště na jazyk jednoháčkové; 15,0 cm	Löbker tongue holding forceps; 15,0 cm	Löbker Zungenhalterzange; 15,0 cm	19
117 50 0010	Kleště extrakční D2	Extraction forceps D2	Zahnzange; 16,8 cm; D2	11
117 50 0020	Kleště extrakční D7	Extraction forceps D7	Zahnzange; 16,4 cm; D7	11
117 50 0030	Kleště extrakční D17	Extraction forceps D17	Zahnzange; 17,2 cm; D17	11
117 50 0040	Kleště extrakční D18	Extraction forceps D18	Zahnzange; 17,2 cm; D18	12
117 50 0050	Kleště extrakční D67	Extraction forceps D67	Zahnzange; 17,4 cm; D67	13
117 50 0060	Kleště extrakční D305	Extraction forceps D305	Zahnzange; 15,0 cm; D305	12
117 50 0150	Kleště extrakční D13	Extraction forceps D13	Zahnzange; 14,9 cm; D13	11
117 50 0160	Kleště extrakční D22	Extraction forceps D22	Zahnzange; 14,9 cm; D22	12
117 50 0170	Kleště extrakční D73	Extraction forceps D73	Zahnzange; 15,0 cm; D73	14
117 50 0180	Kleště extrakční D79	Extraction forceps D79	Zahnzange; 16,5 cm; D79	14
117 50 0190	Kleště extrakční D33A	Extraction forceps D33a	Zahnzange; 14,7 cm; D33S	13
117 50 0200	Kleště extrakční D33	Extraction forceps D33	Zahnzange; 14,7 cm; D33	12
117 50 0250	Kleště extrakční D51A	Extraction forceps D51A	Zahnzange; 18,2 cm; D51A	13
117 50 0260	Kleště extrakční D51	Extraction forceps D51	Zahnzange; 18,2 cm; D51	13
117 50 0300	Kleště extrakční D342	Extraction forceps D342	Kinder-Zahnzange; 11,7 cm; D342	15
117 50 0310	Kleště extrakční D339	Extraction forceps D339	Kinder-Zahnzange; 10,7 cm; D339	15
117 50 0330	Kleště extrakční D74N	Extraction forceps D74N	Zahnzange; 1,5 cm; D74N	14
117 50 0340	Kleště extrakční D74M	Extraction forceps D74M	Zahnzange; 1,5 cm; D74M	14
117 50 0350	Kleště extrakční D74	Extraction forceps D74	Zahnzange; 1,5 cm; D74	14
117 50 1010	Kleště extrakční D2 diamantované	Extraction forceps D2 diamond	Zahnzange dia; 16,8 cm; D2	11
117 50 1020	Kleště extrakční D7 diamantované	Extraction forceps D7 diamond	Zahnzange dia; 16,4 cm; D7	11
117 50 1030	Kleště extrakční D17 diamantované	Extraction forceps D17 diamond	Zahnzange dia; 17,2 cm; D17	11
117 50 1040	Kleště extrakční D18 diamantované	Extraction forceps D18 diamond	Zahnzange dia; 17,2 cm; D18	12
117 50 1050	Kleště extrakční D67 diamantované	Extraction forceps D67 diamond	Zahnzange dia; 17,4 cm; D67	13
117 50 1060	Kleště extrakční D305 diamantované	Extraction forceps D305 diamond	Zahnzange dia; 15,0 cm; D305	12
117 50 1150	Kleště extrakční D13 diamantované	Extraction forceps D13 diamond	Zahnzange dia; 14,9 cm; D13	11
117 50 1160	Kleště extrakční D22 diamantované	Extraction forceps D22 diamond	Zahnzange dia; 14,9 cm; D22	12
117 50 1170	Kleště extrakční D73 diamantované	Extraction forceps D73 diamond	Zahnzange dia; 15,0 cm; D73	14
117 50 1180	Kleště extrakční D79 diamantované	Extraction forceps D79 diamond	Zahnzange dia; 16,5 cm; D79	14
117 50 1190	Kleště extrakční D33A diamantované	Extraction forceps D33A diamond	Zahnzange dia; 14,7 cm; D33A	13
117 50 1200	Kleště extrakční D33 diamantované	Extraction forceps D33 diamond	Zahnzange dia; 14,7 cm; D33	12
117 50 1250	Kleště extrakční D51A diamantované	Extraction forceps D51A diamond	Zahnzange dia; 18,2 cm; D51A	13
117 50 1260	Kleště extrakční D51 diamantované	Extraction forceps D5 diamond	Zahnzange dia; 18,2 cm; D51	13
117 50 1300	Kleště extrakční D342 diamantované	Extraction forceps D342 diamond	Kinder-Zahnzange dia; 11,7 cm; D342	15
117 50 1310	Kleště extrakční D339 diamantované	Extraction forceps D339 diamond	Kinder-Zahnzange dia; 10,7 cm; D339	15
117 50 1330	Kleště extrakční D74N diamantované	Extraction forceps D74N diamond	Zahnzange dia; 1,5 cm; D74N	14
117 50 1340	Kleště extrakční D74M diamantované	Extraction forceps D74M diamond	Zahnzange dia; 1,5 cm; D74M	14
117 50 1350	Kleště extrakční D74 diamantované	Extraction forceps D74 diamond	Zahnzange dia; 1,5 cm; D74	14
117 51 0600	Kleště k odstranění kořen.nástrojů rovné; 13,5 cm	Forceps for extraction of root instruments; 13,5 cm	Wurzelkanal-Zange; 13,5 cm	15
117 51 0610	Kleště k odstranění kořen.nástrojů zahnuté; 13,5 cm	Forceps for extraction of root instruments; 13,5 cm	Wurzelkanal-Zange; 13,3 cm	15
117 51 1600	Kleště k odstranění kořen.nástrojů rovné Dia; 13,5 cm	Forceps for extraction of root instruments straight Dia; 13,5 cm	Wurzelkanal-Zange dia; 13,5 cm	15
117 51 1610	Kleště k odstranění kořen.nástrojů zahnuté Dia; 13,3 cm	Forceps for extraction of root instruments curved Dia; 13,3 cm	Wurzelkanal-Zange dia; 13,3 cm	15
117 52 0700	Kleště laboratorní fig. 1; 13,5 cm	Laboratory forceps fig. 1; 13,5 cm	Kramponzange; 13,5 cm	114, 122
117 52 0770	Kleště na kelímky; 50,0 cm	Crucible forceps; 50,0 cm	Muffelzange; 50,0 cm	113
117 52 0780	Kleště na kelímky; 27,5 cm	Crucible forceps; 27,5 cm	Muffelzange; 27,5 cm	113
117 52 0800	Kleště laboratorní ploché; 13,4 cm	Laboratory forceps with flat jaws; 13,4 cm	Laborzange; 13,4 cm	114
117 52 0810	Kleště laboratorní oblé; 13,4 cm	Laboratory forceps with rounded jaws; 13,4 cm	Laborzange; 13,4 cm	114
117 52 0820	Kleště laboratorní kuželové; 13,4 cm	Laboratory forceps with conical jaws; 13,4 cm	Laborzange; 13,4 cm	114
117 52 0830	Kleště laboratorní čočkové; 13,4 cm	Laboratory forceps with lens jaws; 13,4 cm	Laborzange; 13,4 cm	114
117 52 0840	Kleště laborat.ploché vroubk.celís. fig. 1; 13,5 cm	Laboratory forceps with flat jaws fig. 1; 13,5 cm	Laborzange; 13,5 cm	115
117 52 0850	Kleště laborat.ohýbací se žlábkem fig. 2; 13,3 cm	Laboratory forceps with groove jaws fig. 2; 13,3 cm	Laborzange; 13,3 cm	115
117 52 0860	Kleště laborat.ohýbací se žlábkem fig. 3; 13,0 cm	Laboratory forceps with groove jaws fig. 3; 13,0 cm	Laborzange; 13,0 cm	115
117 52 0870	Kleště laboratorní ploché fig. 4; 13,0 cm	Laboratory forceps with flat jaws fig. 4; 13,0 cm	Laborzange; 13,0 cm	115
117 52 0880	Kleště laboratorní ohýbací velké fig. 5; 12,2 cm	Laboratory bending forceps fig. 5; 12,2 cm	Laborzange; 12,2 cm	116
117 52 0890	Kleště laboratorní ohýbací malé fig. 6; 11,9 cm	Laboratory bending forceps fig. 6; 11,9 cm	Laborzange; 11,9 cm	116
117 52 1000	Kleště laboratorní utahovací; 13,6 cm	Laboratory tighten forceps; 13,6 cm	Laborzange; 13,6 cm	116
117 52 1010	Kleště laboratorní ohýbací; 13,6 cm	Laboratory bending forceps; 13,6 cm	Laborzange; 13,6 cm	116
117 91 0038	Heywood-Smith kleště tamponové; 21,0 cm	Heywood-Smith sponge holding forceps; 21,0 cm	Heywood-Smith Schwammzange; 21,0 cm	19
117 91 0039	Heywood-Smith kleště tamponové; 25,0 cm	Heywood-Smith sponge holding forceps; 25,0 cm	Heywood-Smith Schwammzange; 25,0 cm	19
118	HÁČKY	HOOKS, RETRACTORS	HAKEN, SPERRER	
118 08 0010	Háček na rány jednozubý ostrý; 16,0 cm	Delicate hook one-pronged sharp; 16,0 cm	Feiner Wundhaken scharf; 16,0 cm	31
118 08 0020	Háček na rány dvouzubý ostrý; 16,0 cm	Delicate hook two-pronged sharp; 16,0 cm	Feiner Wundhaken 2-zinkig scharf; 16,0 cm	31
118 08 0050	Háček na rány jednozubý tupý; 16,0 cm	Delicate hook one-pronged blunt; 16,0 cm	Feiner Wundhaken stumpf; 16,0 cm	31
118 08 0060	Háček na rány dvouzubý tupý; 16,0 cm	Delicate hook two-pronged blunt; 16,0 cm	Feiner Wundhaken 2-zinkig stumpf; 16,0 cm	31
118 08 0650	Middeldorpf hák na rány okénk.; 14×12 mm; 22,0 cm	Middeldorpf retractor; 14×12 mm; 22,0 cm	Middeldorpf Wundhaken; 14×12 mm; 22,0 cm	34
118 08 0660	Middeldorpf hák na rány okénk.; 21×21 mm; 22,0 cm	Middeldorpf retractor; 21×21 mm; 22,0 cm	Middeldorpf Wundhaken; 21×21 mm; 22,0 cm	34
118 08 0670	Middeldorpf hák na rány okénk.; 32×31 mm; 23,5 cm	Middeldorpf retractor; 32×31 mm; 23,5 cm	Middeldorpf Wundhaken; 32×31 mm; 23,5 cm	34
118 08 0680	Middeldorpf hák na rány okénk.; 62×50 mm; 28,0 cm	Middeldorpf retractor; 62×50 mm; 28,0 cm	Middeldorpf Wundhaken; 62×50 mm; 28,0 cm	34
118 08 0800	Langenbeck hák na rány; 40×10 mm; 21,0 cm	Langenbeck retractor; 40×10 mm; 21,0 cm	Langenbeck Wundhaken; 40×10 mm; 21,0 cm	33

číslo – number	název	item	Artikel	strana – page
118 08 0810	Langenbeck hák na rány; 42×13 mm; 21,0 cm	Langenbeck retractor; 42×13 mm; 21,0 cm	Langenbeck Wundhaken; 42×13 mm; 21,0 cm	33
118 12 0010	Háček pro plastiku jednozubý ostrý fig. 1; 16,0 cm	Plastic hook one-pronged sharp; fig. 1; 16,0 cm	Plastikhaken 1-zinkig scharf Fig.1; 16,0 cm	33
118 12 0020	Háček pro plastiku jednozubý ostrý fig. 2; 16,0 cm	Plastic hook one-pronged sharp; fig. 2; 16,0 cm	Plastikhaken 1-zinkig scharf Fig.2; 16,0 cm	33
118 31 0040	Hák resekční čtyřzubý rovný; 16,4 cm	Resection hook four-pronged straight; 16,4 cm	Resektionshaken; 16,4 cm	35
118 31 0050	Hák resekční čtyřzubý pravý; 16,2 cm	Resection hook four-pronged right; 16,2 cm	Resektionshaken; 16,2 cm	35
118 31 0060	Hák resekční čtyřzubý levý; 16,2 cm	Resection hook four-pronged left; 16,2 cm	Resektionshaken; 16,2 cm	35
118 31 0070	Hák resekční dvouzubý rovný; 16,4 cm	Resection hook two-pronged straight; 16,4 cm	Resektionshaken; 16,4 cm	35
118 31 0080	Hák resekční dvouzubý pravý; 16,1 cm	Resection hook two-pronged right; 16,1 cm	Resektionshaken; 16,1 cm	35
118 31 0090	Hák resekční dvouzubý levý; 16,1 cm	Resection hook two-pronged left; 16,1 cm	Resektionshaken; 16,1 cm	35
118 38 0010	Desmarres háček jemný; 10,0 mm; 13,0 cm	Desmarres delicate hook; 10,0 mm; 13,0 cm	Desmarres Wundhaken; 10,0 mm; 13,0 cm	32
118 38 0020	Desmarres háček jemný; 12,0 mm; 13,0 cm	Desmarres delicate hook; 12,0 mm; 13,0 cm	Desmarres Wundhaken; 12,0 mm; 13,0 cm	32
118 38 0030	Desmarres háček jemný; 14,0 mm; 13,0 cm	Desmarres delicate hook; 14,0 mm; 13,0 cm	Desmarres Wundhaken; 14,0 mm; 13,0 cm	32
118 38 0210	Háček oční dvouzubý ostrý; 2,6 mm; 13,5 cm	Eye hook two-pronged sharp; 2,6 mm; 13,5 cm	Augenhaken 2-zinkig scharf; 2,6 mm; 13,5 cm	33
118 38 0220	Háček oční dvouzubý ostrý; 3,2 mm; 13,5 cm	Eye hook two-pronged sharp; 3,2 mm; 13,5 cm	Augenhaken 2-zinkig scharf; 3,2 mm; 13,5 cm	33
118 38 0230	Háček oční dvouzubý ostrý; 4,0 mm; 13,5 cm	Eye hook two-pronged sharp; 4,0 mm; 13,5 cm	Augenhaken 2-zinkig scharf; 4,0 mm; 13,5 cm	33
118 38 0360	Háček oční čtyřzubý ostrý; 5,0 mm; 14,5 cm	Eye hook four-pronged sharp; 5,0 mm; 14,5 cm	Augenhaken 4-zinkig scharf; 5,0 mm; 14,5 cm	33
118 50 0120	Hák intraorální; 22,9 cm	Intraoral hook; 22,9 cm	Intra-oral-Haken; 22,9 cm	36
118 91 0027	Háček na rány trojzubý ostrý; 16,0 cm	Delicate hook three-pronged sharp; 16,0 cm	Wundhaken 3-zinkig scharf; 16,0 cm	31
118 91 0028	Háček na rány čtyřzubý ostrý; 16,0 cm	Delicate hook four-pronged sharp; 16,0 cm	Wundhaken 4-zinkig scharf; 16,0 cm	31
118 91 0035	Háček na rány trojzubý tupý; 16,0 cm	Delicate hook three-pronged blunt; 16,0 cm	Wundhaken 3-zinkig stumpf; 16,0 cm	31
118 91 0036	Háček na rány čtyřzubý tupý; 16,0 cm	Delicate hook four-pronged blunt; 16,0 cm	Wundhaken 4-zinkig stumpf; 16,0 cm	31
118 91 0045	Háček na rány dvouzubý ostrý; 16,0 cm	Delicate hook two-pronged sharp; 16,0 cm	Wundhaken 2-zinkig scharf flexibel; 16,0 cm	31
118 91 0046	Háček na rány trojzubý ostrý; 16,0 cm	Delicate hook three-pronged sharp; 16,0 cm	Wundhaken 3-zinkig scharf flexibel; 16,0 cm	31
118 91 0047	Háček na rány čtyřzubý ostrý; 16,0 cm	Delicate hook four-pronged sharp; 16,0 cm	Wundhaken 4-zinkig scharf flexibel; 16,0 cm	31
118 91 0048	Háček na rány dvouzubý tupý; 16,0 cm	Delicate hook two-pronged blunt; 16,0 cm	Wundhaken 2-zinkig stumpf flexibel; 16,0 cm	31
118 91 0049	Háček na rány trojzubý tupý; 16,0 cm	Delicate hook three-pronged blunt; 16,0 cm	Wundhaken 3-zinkig stumpf flexibel; 16,0 cm	31
118 91 0050	Háček na rány čtyřzubý tupý; 16,0 cm	Delicate hook four-pronged blunt; 16,0 cm	Wundhaken 4-zinkig stumpf flexibel; 16,0 cm	31
118 91 0051	Joseph háček na rány jednozubý ostrý; 16,0 cm	Joseph delicate hook one-pronged sharp; 16,0 cm	Joseph feiner Wundhaken; 16,0 cm	31
118 91 0052	Joseph háček na rány dvouzubý ostrý; 2,0 mm; 16,0 cm	Joseph delicate hook two-pronged sharp; 16,0 cm	Joseph feiner Wundhaken; 2 mm; 16,0 cm	31
118 91 0053	Joseph háček na rány dvouzubý ostrý; 5,0 mm; 16,0 cm	Joseph delicate hook two-pronged sharp; 16,0 cm	Joseph feiner Wundhaken; 5 mm; 16,0 cm	31
118 91 0054	Joseph háček na rány dvouzubý ostrý; 7,0 mm; 16,0 cm	Joseph delicate hook two-pronged sharp; 16,0 cm	Joseph feiner Wundhaken; 7 mm; 16,0 cm	31
118 91 0055	Joseph háček na rány dvouzubý ostrý; 10,0 mm; 16,0 cm	Joseph delicate hook two-pronged sharp; 16,0 cm	Joseph feiner Wundhaken; 10 mm; 16,0 cm	31
118 91 0069	Mini-Langenbeck háček jemný; 16,0 cm	Mini-Langenbeck delicate hook; 16,0 cm	Mini-Langenbeck Wundhaken; 10×6 mm; 16,0 cm	32
118 91 0070	Mini-Langenbeck háček jemný; 16,0 cm	Mini-Langenbeck delicate hook; 16,0 cm	Mini-Langenbeck Wundhaken; 17×6 mm; 16,0 cm	32
118 91 0071	Mini-Langenbeck háček jemný; 16,0 cm	Mini-Langenbeck delicate hook; 16,0 cm	Mini-Langenbeck Wundhaken; 20×6 mm; 16,0 cm	32
118 91 0072	Mini-Langenbeck háček jemný; 16,0 cm	Mini-Langenbeck delicate hook; 16,0 cm	Mini-Langenbeck Wundhaken; 22×8 mm; 16,0 cm	32
118 91 0077	Desmarres háček jemný; 16,0 mm; 13,0 cm	Desmarres delicate hook; 16,0 mm; 13,0 cm	Desmarres Wundhaken; 16,0 mm; 13,0 cm	32
118 91 0078	Desmarres háček jemný; 18,0 mm; 13,0 cm	Desmarres delicate hook; 18,0 mm; 13,0 cm	Desmarres Wundhaken; 18,0 mm; 13,0 cm	32
118 91 0085	Cushing háček jemný; 8,0 mm; 20,0 cm	Cushing delicate hook; 8,0 mm; 20,0 cm	Cushing Wundhaken; 8,0 mm; 20,0 cm	32
118 91 0086	Cushing háček jemný; 10,0 mm; 20,0 cm	Cushing delicate hook; 10,0 mm; 20,0 cm	Cushing Wundhaken; 10,0 mm; 20,0 cm	32
118 91 0087	Cushing háček jemný; 12,0 mm; 20,0 cm	Cushing delicate hook; 12,0 mm; 20,0 cm	Cushing Wundhaken; 12,0 mm; 20,0 cm	32
118 91 0088	Cushing háček jemný; 14,0 mm; 20,0 cm	Cushing delicate hook; 14,0 mm; 20,0 cm	Cushing Wundhaken; 14,0 mm; 20,0 cm	32
118 91 0089	Cushing háček jemný; 16,0 mm; 20,0 cm	Cushing delicate hook; 16,0 mm; 20,0 cm	Cushing Wundhaken; 16,0 mm; 20,0 cm	32
118 91 0090	Cushing háček jemný; 18,0 mm; 20,0 cm	Cushing delicate hook; 18,0 mm; 20,0 cm	Cushing Wundhaken; 18,0 mm; 20,0 cm	32
118 91 0091	Cushing háček jemný; 8,0 mm; 24,0 cm	Cushing delicate hook; 8,0 mm; 24,0 cm	Cushing Wundhaken; 8,0 mm; 24,0 cm	32
118 91 0092	Cushing háček jemný; 10,0 mm; 24,0 cm	Cushing delicate hook; 10,0 mm; 24,0 cm	Cushing Wundhaken; 10,0 mm; 24,0 cm	32
118 91 0093	Cushing háček jemný; 12,0 mm; 24,0 cm	Cushing delicate hook; 12,0 mm; 24,0 cm	Cushing Wundhaken; 12,0 mm; 24,0 cm	32
118 91 0094	Cushing háček jemný; 14,0 mm; 24,0 cm	Cushing delicate hook; 14,0 mm; 24,0 cm	Cushing Wundhaken; 14,0 mm; 24,0 cm	32
118 91 0095	Cushing háček jemný; 16,0 mm; 24,0 cm	Cushing delicate hook; 16,0 mm; 24,0 cm	Cushing Wundhaken; 16,0 mm; 24,0 cm	32
118 91 0096	Cushing háček jemný; 18,0 mm; 24,0 cm	Cushing delicate hook; 18,0 mm; 24,0 cm	Cushing Wundhaken; 18,0 mm; 24,0 cm	32
118 91 0208	Middeldorpf hák na rány okénk.; 14×17 mm; 21,5 cm	Middeldorpf retractor; 14×17 mm; 21,5 cm	Middeldorpf Wundhaken; 14×17 mm; 21,5 cm	34
118 91 0209	Middeldorpf hák na rány okénk.; 20×22 mm; 22,0 cm	Middeldorpf retractor; 20×22 mm; 22,0 cm	Middeldorpf Wundhaken; 20×22 mm; 22,0 cm	34
118 91 0210	Middeldorpf hák na rány okénk.; 26×30 mm; 23,5 cm	Middeldorpf retractor; 26×30 mm; 23,5 cm	Middeldorpf Wundhaken; 26×30 mm; 23,5 cm	34
119	ROZVĚRAČE	RETRACTORS	MUNDSPERRER	
119 07 0010	Roser-König rozvěrač úst; 19,5 cm	Roser-König mouth retractor; 19,5 cm	Roser-König Mundsperrerr; 19,5 cm	37
119 07 0020	Heister rozvěrač úst; 13,0 cm	Heister mouth retractor; 13,0 cm	Heister Mundsperrerr; 13,0 cm	37
119 91 0185	Jennings rozvěrač úst; 9,0 cm	Jennings mouth retractor; 9,0 cm	Jennings Mundsperrerr; 9,0 cm	38
119 91 0186	Jennings rozvěrač úst; 11,0 cm	Jennings mouth retractor; 11,0 cm	Jennings Mundsperrerr; 11,0 cm	38
119 91 0187	Jennings rozvěrač úst; 13,0 cm	Jennings mouth retractor; 13,0 cm	Jennings Mundsperrerr; 13,0 cm	38
119 91 0188	Jennings rozvěrač úst; 15,0 cm	Jennings mouth retractor; 15,0 cm	Jennings Mundsperrerr; 15,0 cm	38
119 91 0189	Whitehead rozvěrač úst; 9,0 cm	Whitehead mouth retractor; 9,0 cm	Whitehead Mundsperrerr; 9,0 cm	38
119 91 0190	Whitehead rozvěrač úst; 11,0 cm	Whitehead mouth retractor; 11,0 cm	Whitehead Mundsperrerr; 11,0 cm	38
119 91 0191	Whitehead rozvěrač úst; 13,0 cm	Whitehead mouth retractor; 13,0 cm	Whitehead Mundsperrerr; 13,0 cm	38
119 91 0192	Whitehead rozvěrač úst; 15,0 cm	Whitehead mouth retractor; 15,0 cm	Whitehead Mundsperrerr; 15,0 cm	38
119 91 0193	Whitehead rozvěrač úst; 9,0 cm	Whitehead mouth retractor; 9,0 cm	Whitehead Mundsperrerr; 9,0 cm	38
119 91 0194	Whitehead rozvěrač úst; 11,0 cm	Whitehead mouth retractor; 11,0 cm	Whitehead Mundsperrerr; 11,0 cm	38
119 91 0195	Whitehead rozvěrač úst; 13,0 cm	Whitehead mouth retractor; 13,0 cm	Whitehead Mundsperrerr; 13,0 cm	38
119 91 0196	Whitehead rozvěrač úst; 15,0 cm	Whitehead mouth retractor; 15,0 cm	Whitehead Mundsperrerr; 15,0 cm	38
121	LOPATKY	SPATULAS	SPATELN	
121 31 0010	Buchwald lopatka na jazyk; 16×23 mm; 17,3 cm	Buchwald tongue spatula; 16×23 mm; 17,3 cm	Buchwald Zungenspatel; 16×23 mm; 17,3 cm	72
121 31 0020	Brünnings lopatka na jazyk; 14×18 mm; 19,5 cm	Brünnings tongue spatula; 14×18 mm; 19,5 cm	Brünnings Zungenspatel; 14×18 mm; 19,5 cm	72
121 52 0010	Lopatka na cement oboustranná; 5 mm; 18,0 cm	Cement spatula; 5 mm; 18,0 cm	Gipsspatel beiderseitig; 5,0 mm	91, 121
121 52 0020	Lopatka na cement oboustranná; 7,5 mm; 18,0 cm	Cement spatula; 7,5 mm; 18,0 cm	Gipsspatel beiderseitig; 7,5 mm	91, 121
121 52 0050	Nůž na sádku s otvíračem kyvet; 18,0 cm	Plaster knife; 18,0 cm	Gipsmesser mit Küvettenöffner; 18,0 cm	121, 122
121 52 0060	Lopatka na sádku; 16,8 cm	Plaster spatula; 16,8 cm	Gipsspatel; 16,8 cm	121
121 52 0080	Lopatka na míchání otiskovýchmot; 21,0 cm	Mixing spatula; 21,0 cm	Spatel für Abdruckmassen; 21,0 cm	91, 121
122	ZRCÁTKA	MIRRORS	MUNDSPIEGEL	
122 51 0010	Zrcátko zubní ploché; 2,4 cm	Mouth mirror flat; 2,4 cm	Mundspiegel flach; 2,4 mm	73
122 51 0020	Zrcátko zubní zvětšovací; 2,4 cm	Mouth mirror magnifying; 2,4 cm	Mundspiegel vergrößend 2,4; mm	73, 74
122 51 0100	Držátko zubního zrcátka; 12,0 cm	Mirror handle; 12,0 cm	Mundspiegelgriff rostfrei; 12,0 cm	73, 74
122 51 0106	Držátko zubního zrcátka; 12,0 cm	Mirror handle; 12,0 cm	Mundspiegelgriff; 12,0 cm	73

číslo – number	název	item	Artikel	strana – page
122 56 0106	Držátko zubního zrcátka; 12,0 cm	Dental mirror hollow handle; 12,0 cm	Mundspiegelgriff; 12,0 cm	73
122 91 0333	Zrcátko zubní ploché; 2,4 cm	Mouth mirror flat; 2,4 cm	Mundspiegel flach; 2,4 mm	73
122 91 0408	Zrcátko zubní; vel. 0; 14 mm	Mouth mirror; size 0; 14 mm	Mundspiegel Größe 0; 2,4 mm	73
123	PÁČIDLA, PÁKY	ELEVATORS	ELEVATOREN, WURZELHEBER	
123 08 0010	Langenbeck páčidlo fig. 1; 19,5 cm	Langenbeck elevator; fig. 1; 19,5 cm	Langenbeck Elevator Fig.1; 19,5 cm	20
123 08 0020	Langenbeck páčidlo fig. 2; 19,5 cm	Langenbeck elevator; fig. 2; 19,5 cm	Langenbeck Elevator Fig.2; 19,5 cm	20
123 08 0030	Williger páčidlo fig. 1; 16,0 cm	Williger elevator; fig. 1; 16,0 cm	Williger Elevator Fig.1; 16,0 cm	20
123 30 0030	Freer páčidlo na nosní přepážku dvojité; 17,9 cm	Freer septum elevator; 17,9 cm	Freer Septum-elevator 4,5 mm; 17,9 cm	20
123 50 0010	Bein páka extrakční rovná; 3 mm; 14,5 cm	Bein root elevator straight; 3 mm; 14,5 cm	Bein Wurzelheber; 3 mm; 14,5 cm	21
123 50 0011	Bein páka extrakční rovná; 3 mm; 16,5 cm	Bein root elevator straight; 3 mm; 16,5 cm	Bein Wurzelheber; 3 mm; 16,5 cm	21
123 50 0020	Bein páka extrakční rovná; 4 mm; 14,5 cm	Bein root elevator straight; 4 mm; 14,5 cm	Bein Wurzelheber; 4 mm; 14,5 cm	21
123 50 0021	Bein páka extrakční rovná; 4 mm; 16,5 cm	Bein root elevator straight; 4 mm; 16,5 cm	Bein Wurzelheber; 4 mm; 16,5 cm	21
123 50 0050	Bein páka extrakční oblouk; 3 mm; 14,5 cm	Bein root elevator embowed; 3 mm; 14,5 cm	Bein Wurzelheber; 3 mm; 14,5 cm	21
123 50 0051	Bein páka extrakční oblouk; 3 mm; 16,5 cm	Bein root elevator embowed; 3 mm; 16,5 cm	Bein Wurzelheber; 3 mm; 16,5 cm	21
123 50 0060	Bein páka extrakční oblouk; 4 mm; 14,5 cm	Bein root elevator embowed; 4 mm; 14,5 cm	Bein Wurzelheber; 4 mm; 14,5 cm	21
123 50 0061	Bein páka extrakční oblouk; 4 mm; 16,5 cm	Bein root elevator embowed; 4 mm; 16,5 cm	Bein Wurzelheber; 4 mm; 16,5 cm	21
123 50 0080	Bein páka extrakční hrotnatá jemná; 3 mm; 14,5 cm	Bein root elevator straight fine; 3 mm; 14,5 cm	Bein Wurzelheber; 3 mm; 14,5 cm	22
123 50 0081	Bein páka extrakční rovná jemná; 3 mm; 16,5 cm	Bein root elevator straight fine; 3 mm; 16,5 cm	Bein Wurzelheber; 3 mm; 16,5 cm	22
123 50 0090	Bein páka extrakční rovná jemná; 4 mm; 14,5 cm	Bein root elevator straight fine; 4 mm; 14,5 cm	Bein Wurzelheber; 4 mm; 14,5 cm	22
123 50 0091	Bein páka extrakční rovná jemná; 4 mm; 16,5 cm	Bein root elevator straight fine; 4 mm; 16,5 cm	Bein Wurzelheber; 4 mm; 16,5 cm	22
123 50 0100	Flohr páka extrakční hrotnatá pravá; 3 mm; 13,0 cm	Flohr root elevator pointed right fine; 3 mm; 13,0 cm	Flohr Wurzelheber; 3 mm; 13,0 cm	22
123 50 0101	Flohr páka extrakční hrotnatá pravá; 3 mm; 15,0 cm	Flohr root elevator pointed right fine; 3 mm; 15,0 cm	Flohr Wurzelheber; 3 mm; 15,0 cm	22
123 50 0110	Flohr páka extrakční hrotnatá levá; 3 mm; 13,0 cm	Flohr root elevator pointed left fine; 3 mm; 13,0 cm	Flohr Wurzelheber; 3 mm; 13,0 cm	22
123 50 0111	Flohr páka extrakční hrotnatá levá; 3 mm; 15,0 cm	Flohr root elevator pointed left fine; 3 mm; 15,0 cm	Flohr Wurzelheber; 3 mm; 15,0 cm	22
123 50 0130	Schlemmer páka extrakční pravá; 15,1 cm	Schlemmer root elevator right; 15,1 cm	Schlemmer Wurzelheber rechts; 15,1 cm	23
123 50 0131	Schlemmer páka extrakční pravá; 17,1 cm	Schlemmer root elevator right; 17,1 cm	Schlemmer Wurzelheber rechts; 17,1 cm	23
123 50 0140	Schlemmer páka extrakční levá; 15,1 cm	Schlemmer root elevator left; 15,1 cm	Schlemmer Wurzelheber links; 15,1 cm	23
123 50 0141	Schlemmer páka extrakční levá; 17,1 cm	Schlemmer root elevator left; 17,1 cm	Schlemmer Wurzelheber links; 17,1 cm	23
123 50 0160	Páka extrakční rovná pravá; 4 mm; 14,5 cm	Root elevator straight right; 4 mm; 14,5 cm	Wurzelheber rechts; 4 mm; 14,5 cm	23
123 50 0170	Páka extrakční rovná levá; 4 mm; 14,5 cm	Root elevator straight left; 4 mm; 14,5 cm	Wurzelheber links; 4 mm; 14,5 cm	23
123 50 0210	Špinar páka extrakční přední; 4 mm; 14,8 cm	Špinar root elevator frontal; 4 mm; 14,8 cm	Špinar Wurzelheber; 4 mm; 14,8 cm	24
123 50 0211	Špinar páka extrakční přední; 4 mm; 16,8 cm	Špinar root elevator frontal; 4 mm; 16,8 cm	Špinar Wurzelheber; 4 mm; 16,8 cm	24
123 50 0220	Špinar páka extrakční zadní; 4 mm; 14,8 cm	Špinar root elevator retral; 4 mm; 14,8 cm	Špinar Wurzelheber; 4 mm; 14,8 cm	24
123 50 0221	Špinar páka extrakční zadní; 4 mm; 16,8 cm	Špinar root elevator retral; 4 mm; 16,8 cm	Špinar Wurzelheber; 4 mm; 16,8 cm	24
123 50 0280	White páka extrakční s oblouk. ostřím vyhn.; 3 mm; 14,5 cm	Root elevator with embowed edge; 3 mm; 14,5 cm	White Wurzelheber; 3 mm; 14,5 cm	24
123 50 0290	White páka extrakční s oblouk. ostřím vyhn.; 4 mm; 14,5 cm	Root elevator with embowed edge; 4 mm; 14,5 cm	White Wurzelheber; 4 mm; 14,5 cm	24
123 50 0301	Barry páka extrakční pravá; 9,5 mm; 12,4 cm	Barry root elevator right; 9,5 mm; 12,4 cm	Barry Wurzelheber; 9,5 mm; 12,4 cm	25
123 50 0311	Barry páka extrakční levá; 9,5 mm; 12,4 cm	Barry root elevator left; 9,5 mm; 12,4 cm	Barry Wurzelheber; 9,5 mm; 12,4 cm	25
123 50 0361	Lecluse páka extrakční; 6,5 mm; 10,8 cm	Lecluse root elevator; 6,5 mm; 10,8 cm	Lecluse Wurzelheber; 6,5 mm; 10,8 cm	25
123 50 0380	White páka extrakční s oblouk. ostřím vyhn.; 3 mm; 14,5 cm	Root elevator with embowed edge; 3 mm; 14,5 cm	White Wurzelheber; 3 mm; 14,5 cm	25
123 50 0390	White páka extrakční s oblouk. ostřím vyhn.; 4 mm; 14,5 cm	Root elevator with embowed edge; 4 mm; 14,5 cm	White Wurzelheber; 4 mm; 14,5 cm	25
123 50 0610	Nástroj na snímání korunek; 23,3 cm	Crown remover; 23,3 cm	Kronenabnehmer; 23,3 cm	94
123 50 0630	Páka extrakční se zuby rovná; 4 mm; 14,5 cm	Root elevator with saw edge; 4 mm; 14,5 cm	Wurzelheber; 4 mm; 14,5 cm	25
123 50 0640	Wamkey nástroj na snímání korunek; 14,5 cm	Wamkey crown remover; 14,5 cm	Wamkey Kronenabnehmer; 14,5 cm	94
123 50 0650	Wamkey nástroj na snímání korunek; 14,5 cm	Wamkey crown remover; 14,5 cm	Wamkey Kronenabnehmer; 14,5 cm	94
123 50 0660	Wamkey nástroj na snímání korunek; 14,5 cm	Wamkey crown remover; 14,5 cm	Wamkey Kronenabnehmer; 14,5 cm	94
123 91 0006	Freer páčidlo nosní ostré; 19,0 cm	Freer nasal elevator; 19,0 cm	Freer Septum-elevator Scharf; 19,0 cm	20
123 91 0007	Freer páčidlo nosní tupé; 19,0 cm	Freer nasal elevator; 19,0 cm	Freer Septum-elevator Stumpf; 19,0 cm	20
123 91 0008	Freer páčidlo nosní ostro-tupé; 18,0 cm	Freer nasal elevator; 18,0 cm	Freer Septum-elevator Scharf/stumpf; 18 cm	20
123 99 0084	Páčidlo na nosní přepážku	Septum nasal elevator	Nasenelevator; 3,8/4,2 mm; 17,0 mm	20
124	ŠKRABKY	RASPATORIES	RASPATORIEN	
124 08 0111	Williger škrabka fig. 2; 16,0 cm	Williger raspatory; fig. 2; 16,0 cm	Williger Raspatorium Fig.2; 6 mm; 16,0 cm	26
124 08 0120	Langenbeck škrabka; 20,5 cm	Langenbeck raspatory; 20,5 cm	Langenbeck Raspatorium; 13 mm; 20,5 cm	26
124 08 0130	Langenbeck škrabka; 20,4 cm	Langenbeck raspatory; 20,4 cm	Langenbeck Raspatorium 7 mm 20,4 cm	26
124 08 0250	Williger škrabka 5 mm; 18,0 cm	Williger raspatory; 18,0 cm	Williger Raspatorium; 18,0 cm	26
124 08 0280	Williger škrabka rovná 3,5 mm; 16,0 cm	Williger raspatory; 16,0 cm	Williger Raspatorium; 16,0 cm	26
124 08 0290	Williger škrabka zahnutá 3,5 mm; 16,0 cm	Williger raspatory; 16,0 cm	Williger Raspatorium; 16,0 cm	26
124 30 0020	Přecechtěl škrabka nosní; 19,0 cm	Přecechtěl nasal raspatory; 19,0 cm	Přecechtěl Nasenraspatorium; 19,0 cm	26
124 38 0160	Škrabka na operaci slzného vaku; 17,2 cm	Lachrymal sac raspatory; 17,2 cm	Tränensack-raspatorium; 17,2 cm	26
124 58 0010	Furkační kyreta; 17,2 cm	Furcation curette; 17,2 cm	Furkations-kürette; 17,2 cm	101
124 58 0020	Furkační kyreta; 17,2 cm	Furcation curette; 17,2 cm	Furkations-kürette; 17,2 cm	101
125	LŽÍČKY	BONE CURETTES, SPOONS	LÖFFEL	
125 08 0110	Lžička ostrá fig. 000; 17,0 cm	Sharp spoon; fig. 000; 17,0 cm	Scharfer Löffel Fig.000; 17,0 cm	40
125 08 0120	Lžička ostrá fig. 0; 17,2 cm	Sharp spoon; fig. 0; 17,2 cm	Scharfer Löffel Fig.0; 17,2 cm	40
125 08 0130	Lžička ostrá fig. 1; 17,5 cm	Sharp spoon; fig. 1; 17,5 cm	Scharfer Löffel Fig.1; 17,5 cm	40
125 08 0140	Lžička ostrá fig. 3; 17,7 cm	Sharp spoon; fig. 3; 17,7 cm	Scharfer Löffel Fig.3; 17,7 cm	40
125 08 0150	Lžička ostrá fig. 5; 18,4 cm	Sharp spoon; fig. 5; 18,4 cm	Scharfer Löffel Fig.5; 18,4 cm	40
125 08 0160	Lžička ostrá fig. 1; 16,5 cm	Sharp spoon; fig. 1; 16,5 cm	Scharfer Löffel Fig.1; 16,5 cm	40
125 08 0170	Lžička ostrá fig. 2; 16,5 cm	Sharp spoon; fig. 2; 16,5 cm	Scharfer Löffel Fig.2; 16,5 cm	40
125 08 0180	Lžička ostrá fig. 3; 17,5 cm	Sharp spoon; fig. 3; 17,5 cm	Scharfer Löffel Fig.3; 17,5 cm	40
125 08 0190	Lžička ostrá fig. 4; 17,5 cm	Sharp spoon; fig. 4; 17,5 cm	Scharfer Löffel Fig.4; 17,5 cm	40
125 08 0200	Lžička ostrá fig. 5; 19,5 cm	Sharp spoon; fig. 5; 19,5 cm	Scharfer Löffel Fig.5; 19,5 cm	40
125 08 0210	Lžička ostrá fig. 6; 19,5 cm	Sharp spoon; fig. 6; 19,5 cm	Scharfer Löffel Fig.6; 19,5 cm	40
125 50 0010	Lžička oboustranná; 17,0 cm	Bone curette double-faced; 17,0 cm	Scharfe Löffel beiderseitig; 17,0 cm	39
125 50 0050	Lžička oboustranná lomená ostrá; 2 mm; 17,0 cm	Bone curette double-faced; 2 mm; 17,0 cm	Scharfe Löffel beiderseitig; 17,5 cm	39
125 50 0060	Lžička oboustranná lomená ostrá; 3 mm; 17,0 cm	Bone curette double-faced; 3 mm; 17,0 cm	Scharfe Löffel beiderseitig; 17,5 cm	39
125 50 0070	Lžička oboustranná lomená ostrá; 4 mm; 17,0 cm	Bone curette double-faced; 4 mm; 17,0 cm	Scharfe Löffel beiderseitig; 17,5 cm	39
125 50 0090	Lžička oboustranná lomená ostrá; 6 mm; 17,0 cm	Bone curette double-faced; 6 mm; 17,0 cm	Scharfe Löffel beiderseitig; 17,4 cm	39
125 50 0100	Lžička exkochleální bajonetová pravá; 16,3 cm	Bone curette; 16,3 cm	Scharfe Löffel rechts baj-form; 16,3 cm	41
125 50 0110	Lžička exkochleální bajonetová levá; 16,3 cm	Bone curette; 16,3 cm	Scharfe Löffel links baj-form; 16,3 cm	41
125 51 0156	Lžička oboustranná ostrá; 1,5 mm; 16,6 cm	Bone curette double-faced; 1,5 mm; 16,6 cm	Scharfe Löffel beiderseitig; 17,4 cm	39

číslo – number	název	item	Artikel	strana – page
125 51 0166	Lžička oboustranná ostrá; 2,0 mm; 17,4 cm	Bone curette double-faced; 2,0 mm; 17,4 cm	Scharfe Löffel beiderseitig; 17,4 cm	39
125 51 0176	Lžička oboustranná ostrá; 2,5 mm; 16,6 cm	Bone curette double-faced; 2,5 mm; 16,6 cm	Scharfe Löffel beiderseitig; 16,6 cm	39
125 53 0010	Lžička laboratorní; 15,0 cm	Laboratory spoon; 15,0 cm	Laborlöffel; 15,0 cm	121
125 53 0020	Lžička laboratorní; 20,0 cm	Laboratory spoon; 20,0 cm	Laborlöffel; 20,0 cm	121
125 56 0066	Lžička ostrá oboustranná; 3,0 mm; 16,7 cm	Bone curette double-faced hollow handle; 3,0 mm; 16,7 cm	Scharfe Löffel beiderseitig Hohlgriff	39
125 56 0156	Lžička ostrá oboustranná; 1,5 mm; 16,6 cm	Bone curette double-faced hollow handle; 1,5 mm; 16,6 cm	Scharfe Löffel beiderseitig Hohlgriff	39
125 56 0166	Lžička ostrá oboustranná; 2,0 mm; 16,6 cm	Bone curette double-faced hollow handle; 2,0 mm; 16,6 cm	Scharfe Löffel beiderseitig Hohlgriff	39
125 56 0176	Lžička ostrá oboustranná; 2,5 mm; 16,6 cm	Bone curette double-faced hollow handle; 2,5 mm; 16,6 cm	Scharfe Löffel beiderseitig Hohlgriff	39
126	KYRETY	CURETTES	KÜRETTEN	
126 53 0010	Testovací tyčinka PMMA	Plastic test stick	Teststäbchen aus Kunststoff	101
126 58 0056	Gracey kyreta 1/2; 17,4 cm	Gracey curette 1/2; 17,4 cm	Gracey Kürette 1/2; 17,4 cm	98, 100
126 58 0066	Gracey kyreta 3/4; 17,4 cm	Gracey curette 3/4; 17,4 cm	Gracey Kürette 3/4; 17,4 cm	98, 100
126 58 0076	Gracey kyreta 5/6; 17,3 cm	Gracey curette 5/6; 17,3 cm	Gracey Kürette 5/6; 17,3 cm	98, 100
126 58 0086	Gracey kyreta 7/8; 17,0 cm	Gracey curette 7/8; 17,0 cm	Gracey Kürette 7/8; 17,0 cm	98, 100
126 58 0096	Scaler oboustranný; 16,7 cm	Scaler double-faced; 16,7 cm	Zahnreinerger doppelseitig; 16,7 cm	100, 101
126 58 0106	Gracey kyreta 11/12; 17,2 cm	Gracey curette 11/12; 17,2 cm	Gracey Kürette 11/12; 17,2 cm	98, 100
126 58 0116	Gracey kyreta 13/14; 17,0 cm	Gracey curette 13/14; 17,0 cm	Gracey Kürette 13/14; 17,0 cm	98, 100
126 58 0126	Gracey kyreta 15/16; 17,1 cm	Gracey curette 15/16; 17,1 cm	Gracey Kürette 15/16; 17,1 cm	98, 100
126 58 0136	Gracey kyreta 17/18; 15,6 cm	Gracey curette 17/18; 15,6 cm	Gracey Kürette 17/18; 15,6 cm	98, 100
126 58 0146	Gracey kyreta 9/10; 16,5 cm	Gracey curette 9/10; 16,5 cm	Gracey Kürette 9/10; 16,5 cm	98, 100
126 58 1056	Mini Gracey kyreta 1/2; 17,6 cm	Mini Gracey curette 1/2; 17,6 cm	Mini Gracey Kürette 1/2; 17,6 cm	99, 100
126 58 1066	Mini Gracey kyreta 3/4; 17,4 cm	Mini Gracey curette 3/4; 17,4 cm	Mini Gracey Kürette 3/4; 17,4 cm	99, 100
126 58 1076	Mini Gracey kyreta 5/6; 17,5 cm	Mini Gracey curette 5/6; 17,5 cm	Mini Gracey Kürette 5/6; 17,5 cm	99, 100
126 58 1086	Mini Gracey kyreta 7/8; 17,1 cm	Mini Gracey curette 7/8; 17,1 cm	Mini Gracey Kürette 7/8; 17,1 cm	99, 100
126 58 1106	Mini Gracey kyreta 11/12; 17,4 cm	Mini Gracey curette 11/12; 17,4 cm	Mini Gracey Kürette 11/12; 17,4 cm	99, 100
126 58 1116	Mini Gracey kyreta 13/14; 17,4 cm	Mini Gracey curette 13/14; 17,4 cm	Mini Gracey Kürette 13/14; 17,4 cm	99, 100
126 58 1126	Mini Gracey kyreta 15/16; 17,2 cm	Mini Gracey curette 15/16; 17,2 cm	Mini Gracey Kürette 15/16; 17,2 cm	99, 100
126 58 1136	Mini Gracey kyreta 17/18; 15,8 cm	Mini Gracey curette 17/18; 15,8 cm	Mini Gracey Kürette 17/18; 15,8 cm	99, 100
126 58 1146	Mini Gracey kyreta 9/10; 16,7 cm	Mini Gracey curette 9/10; 16,7 cm	Mini Gracey Kürette 9/10; 16,7 cm	99, 100
126 91 0162	Obtahovací kamínek na ostření kyret	Sharpening stone for currettes	Schleifstein zum nachschärfen	101
127	PILKY, PILNÍKY	SAWS, FILES	SÄGEN, FEILEN	
127 08 0270	Pilník; 15,9 cm	Rasp; 15,9 cm	Nasenfeile; 15,9 cm	27
127 30 0100	Joseph pilník, fig. 1; 16,5 cm	Joseph rasp; fig. 1; 16,5 cm	Joseph Nasenfeile Fig.1; 16,5 cm	27
127 30 0110	Joseph pilník, fig. 2; 16,5 cm	Joseph rasp; fig. 2; 16,5 cm	Joseph Nasenfeile Fig.2; 16,5 cm	27
127 30 0120	Joseph pilník, fig. 3; 16,5 cm	Joseph rasp; fig. 3; 16,5 cm	Joseph Nasenfeile Fig.3; 16,5 cm	27
127 30 0130	Joseph pilník, fig. 4; 16,5 cm	Joseph rasp; fig. 4; 16,5 cm	Joseph Nasenfeile Fig.4; 16,5 cm	27
127 50 0001	List k pilce upínací stomatologické; 7,3 cm	Blade of stomatological saw; 7,3 cm	Sägeblatt	120
127 50 0150	Rám upínací pilky stomatologické; 19,0 cm	Frame of stomatological saw; 19,0 cm	Sägebügel; 19,0 cm	120
127 51 1206	Pilník diamantovaný fig. 1; 2x8 mm; 15,0 cm	Diamond file; fig. 1; 2x8 mm; 15,0 cm	Feile dia Fig.1; 2x8 mm; 15,0 cm	108
127 51 1216	Pilník diamantovaný fig. 2; 2x8 mm; 15,0 cm	Diamond file; fig. 2; 2x8 mm; 15,0 cm	Feile dia Fig.2; 2x8 mm; 15,0 cm	108
127 51 1226	Pilník diamantovaný fig. 3; 2x8 mm; 15,2 cm	Diamond file; fig. 3; 2x8 mm; 15,2 cm	Feile dia Fig.3; 2x8 mm; 15,2 cm	108
127 51 1236	Pilník diamantovaný fig. 4; 2x8 mm; 15,2 cm	Diamond file; fig. 4; 2x8 mm; 15,2 cm	Feile dia Fig.4; 2x8 mm; 15,2 cm	108
127 51 1306	Pilník diamantovaný jehlový; 15,0 cm	Diamond file needle; 15,0 cm	Feile dia Fig.5; 2x8 mm; 15,0 cm	108
127 51 1316	Pilník diamantovaný fig. 5; 2x8 mm; 15,0 cm	Diamond file; fig. 5; 2x8 mm; 15,0 cm	Feile dia Fig.6; 2x8 mm; 15,0 cm	108
127 51 1326	Pilník diamantovaný fig. 6; 2x8 mm; 15,0 cm	Diamond file; fig. 6; 2x8 mm; 15,0 cm	Feile dia Fig.7; 2x8 mm; 15,0 cm	108
127 51 1336	Pilník diamantovaný fig. 7; 2x8 mm; 15,0 cm	Diamond file; fig. 7; 2x8 mm; 15,0 cm	Feile dia Fig.8; 2x8 mm; 15,0 cm	108
127 51 1346	Pilník diamantovaný fig. 8; 2x8 mm; 15,0 cm	Diamond file; fig. 8; 2x8 mm; 15,0 cm	Feile dia Fig.9; 2x8 mm; 15,0 cm	108
128	DLÁTA, KLADIVA	CHISELS, MALLETS	MEISSEL, HÄMMER	
128 08 0901	Kladívko chirurgické kovové; 250 g	Surgical mallet; 250 g	Metallhammer; 250 g	30
128 08 0911	Kladívko chirurgické kovové; 500 g	Surgical mallet; 500 g	Metallhammer; 500 g	30
128 30 0010	Dláto žlábkové; 180x2 mm	Gouge grooved; 180x2 mm	Nasenmeißel; 2 mm; 18,0 cm	28
128 30 0030	Dláto žlábkové; 180x4 mm	Gouge grooved; 180x4 mm	Nasenmeißel; 4 mm; 18,0 cm	28
128 30 0040	Dláto žlábkové; 180x5 mm	Gouge grooved; 180x5 mm	Nasenmeißel; 5 mm; 18,0 cm	28
128 30 0200	West dláto žlábkové; 180x2 mm	West gouge grooved; 180x2 mm	West Hohlmeißel; 2 mm; 18,0 cm	28
128 30 0230	West dláto žlábkové; 180x5 mm	West gouge grooved; 180x5 mm	West Hohlmeißel; 5 mm; 18,0 cm	28
128 50 0050	Dláto ploché jemné; 175x3 mm	Chisel flat fine; 175x3 mm	Flachmeißel; 175x3 mm	28
128 50 0060	Dláto ploché jemné; 175x4 mm	Chisel flat fine; 175x4 mm	Flachmeißel; 175x4 mm	28
128 50 0070	Dláto ploché jemné; 175x5 mm	Chisel flat fine; 175x5 mm	Flachmeißel; 175x5 mm	28
128 50 0080	Dláto ploché jemné; 175x6 mm	Chisel flat fine; 175x6 mm	Flachmeißel; 175x6 mm	28
128 50 0110	Dláto poloklínové jemné; 175x3 mm	Chisel half-wedged fine; 175x3 mm	Halbkeilmeißel; 175x3 mm	29
128 50 0120	Dláto poloklínové jemné; 175x4 mm	Chisel half-wedged fine; 175x4 mm	Halbkeilmeißel; 175x4 mm	29
128 50 0130	Dláto poloklínové jemné; 175x5 mm	Chisel half-wedged fine; 175x5 mm	Halbkeilmeißel; 175x5 mm	29
128 50 0140	Dláto poloklínové jemné; 175x6 mm	Chisel half-wedged fine; 175x6 mm	Halbkeilmeißel; 175x6 mm	29
128 50 0200	Dláto žlábkové jemné; 175x3 mm	Chisel grooved fine; 175x3 mm	Hohlmeißel; 175x3 mm	29
128 50 0210	Dláto žlábkové jemné; 175x4 mm	Chisel grooved fine; 175x4 mm	Hohlmeißel; 175x4 mm	29
128 50 0220	Dláto žlábkové jemné; 175x5 mm	Chisel grooved fine; 175x5 mm	Hohlmeißel; 175x5 mm	29
128 50 0230	Dláto žlábkové jemné; 175x6 mm	Chisel grooved fine; 175x6 mm	Hohlmeißel; 175x6 mm	29
128 52 0110	Kladívko laboratorní ocelové; 26,0 cm	Laboratory mallet; 26,0 cm	Metallhammer konvex glänzend; 26,0 cm	126
128 52 0111	Kladívko laboratorní ocelové; 26,0 cm	Laboratory mallet; 26,0 cm	Metallhammer flach mattiert; 26,0 cm	126
129	DLAHY DENTÁLNÍ	DENTAL PLATES	DENTALSCHIENUNGSPLATTEN	
129 51 0100	Dlaha dentální prefabrikovaná; 15,2 cm	Prefabricated plate; 15,2 cm	Dentalschienungsplatte; 15,2 cm	55
132	JEHELCE, ZAVADĚČE	NEEDLE HOLDERS, INTRODUCERS	NADELHALTER, TAMPONSTOPFER	
132 06 0200	Mathieu jehelec bez drážky; 14,0 cm	Mathieu needle holder; 14,0 cm	Mathieu Nadelhalter; 14,0 cm	50
132 06 0220	Mathieu jehelec bez drážky; 17,2 cm	Mathieu needle holder; 17,2 cm	Mathieu Nadelhalter; 17,2 cm	50
132 06 0300	Crile jehelec jemný; 15,0 cm	Crile needle holder fine; 15,0 cm	Crile Nadelhalter; 15,0 cm	50
132 06 0310	Crile jehelec jemný; 15,5 cm	Crile needle holder fine; 15,5 cm	Crile Nadelhalter; 15,5 cm	50
132 06 0341	Jehelec hloubk. rovny provlékací zámek; 16,5 cm	Needle holder; 16,5 cm	Nadelhalter; 16,5 cm	50
132 06 0370	Crile jehelec jemný diamantovaný; 1,6 mm; 15,7 cm	Crile needle holder dia; 1,6 mm; 15,7 cm	Crile Nadelhalter DIA; 15,7 cm	52
132 06 0450	Crile jehelec jemný provlékací zámek (vločka SK); 16,2 cm	Crile needle holder TUC; 16,2 cm	Crile Nadelhalter TUC; 16,2 cm	52
132 06 0500	Mathieu jehelec provl. zámek (vločka SK); 17,2 cm	Mathieu needle holder TUC; 17,2 cm	Mathieu Nadelhalter TUC; 17,2 cm	52
132 06 0510	Mathieu jehelec provl. zámek (vločka SK); 21,5 cm	Mathieu needle holder TUC; 21,5 cm	Mathieu Nadelhalter TUC; 21,5 cm	52

číslo – number	název	item	Artikel	strana – page
132 06 0520	Mathieu jehelec provl. zámek (vlozka SK); 14,0 cm	Mathieu needle holder TUC; 14,0 cm	Mathieu Nadelhalter TUC; 14,0 cm	52
132 06 0600	Ryder jehelec tvrdokov; 16,5 cm	Ryder needle holder TUC; 16,5 cm	Ryder/French-Eye Nadelhalter TUC; 16,5 cm	51
132 06 0610	Jehelec hloubk. rovný (vlozka SK) tvrdokov; 16,5 cm	Needle holder TUC; 16,5 cm	Nadelhalter TUC; 16,5 cm	51
132 06 0640	Ryder jehelec tvrdokov; 20,5 cm	Ryder needle holder TUC; 20,5 cm	Ryder/French-eye Nadelhalter TUC; 20,5 cm	51
132 06 0650	Ryder jehelec tvrdokov; 25,5 cm	Ryder needle holder TUC; 25,5 cm	Ryder/French-eye Nadelhalter TUC; 25,5 cm	51
132 06 0810	Jehelec s vnitřním uzávěrem vroubk.; 20,5 cm	Needle holder; 20,5 cm	Nadelhalter mit Schloss 20,5 cm	50
132 38 0120	Boynton jehelec oční; 12,5 cm	Boynton eye needle holder; 12,5 cm	Boynton-Eye Nadelhalter 12,5 cm	50
132 50 0180	Luniatschek zavaděč drenů; 17,0 cm	Luniatschek drain introducer; 17,0 cm	Luniatschek Tamponstopfer; 17,0 cm	54
132 50 0186	Luniatschek zavaděč drenů; 16,7 cm	Luniatschek drain introducer; 16,7 cm	Luniatschek Tamponstopfer; 16,7 cm	54
132 50 0196	Luniatschek zavaděč drenů se žlábkem; 16,7 cm	Luniatschek drain introducer with groove; 16,7 cm	Luniatschek Tamponstopfer mit Nut; 16,7 cm	54
132 56 0186	Luniatschek zavaděč drenů; 16,8 cm	Luniatschek drain introducer hollow handle; 16,8 cm	Luniatschek Tamponstopfer Hohlgriff; 17,0 cm	54
132 56 0196	Luniatschek zavaděč drenů se žlábkem; 16,8 cm	Luniatschek drain introducer hollow handle; 16,8 cm	Luniatschek Tamponstopfer Hohlgriff; 17,0 cm	54
132 91 0056	Mathieu jehelec bez drážky; 20,0 cm	Mathieu needle holder; 20,0 cm	Mathieu Nadelhalter; 20,0 cm	50
132 91 0057	Mathieu jehelec bez drážky; 24,0 cm	Mathieu needle holder; 24,0 cm	Mathieu Nadelhalter; 24,0 cm	50
132 91 0160	Olsen-Hegar jehelec/nůžky tvrdokov; 14,0 cm	Olsen-Hegar needle holder/scs. TUC; 14,0 cm	Olsen-Hegar Nadelhalter/Schere TUC; 14,0 cm	51
132 91 0161	Olsen-Hegar jehelec/nůžky tvrdokov; 17,0 cm	Olsen-Hegar needle holder/scs. TUC; 17,0 cm	Olsen-Hegar Nadelhalter/Schere TUC; 17,0 cm	51
132 91 0162	Olsen-Hegar jehelec/nůžky tvrdokov; 19,0 cm	Olsen-Hegar needle holder/scs. TUC; 19,0 cm	Olsen-Hegar Nadelhalter/Schere TUC; 19,0 cm	51
132 91 0167	Mathieu jehelec provl. zámek (vlozka SK) tvrdokov; 24,0 cm	Mathieu needle holder TUC; 24,0 cm	Mathieu Nadelhalter TUC; 24,0 cm	52
132 91 0168	Mathieu jehelec jemný tvrdokov; 17,0 cm	Mathieu needle holder TUC; 17,0 cm	Mathieu Nadelhalter TUC inn sp; 17,0 cm	52
132 91 0169	Mathieu jehelec jemný tvrdokov; 20,0 cm	Mathieu needle holder TUC; 20,0 cm	Mathieu Nadelhalter TUC inn sp; 20,0 cm	52
132 91 0170	Mathieu jehelec jemný tvrdokov; 23,0 cm	Mathieu needle holder TUC; 23,0 cm	Mathieu Nadelhalter TUC inn sp; 23,0 cm	52
132 91 0215	Castroviejo jehelec rovný vroubkovaný tvrdokov; 14,0 cm	Castroviejo needle holder TUC; 14,0 cm	Castroviejo Nadelhalter TUC Ger Sp Gerieft; 14,0 cm	53
132 91 0216	Castroviejo jehelec zahnutý vroubkovaný tvrdokov; 14,0 cm	Castroviejo needle holder TUC; 14,0 cm	Castroviejo Nadelhalter TUC Geb Sp Gerieft; 14,0 cm	53
132 91 0219	Castroviejo jehelec rovný vroubkovaný tvrdokov; 18,0 cm	Castroviejo micro-needle holder TUC; 18,0 cm	Castroviejo Mikro-Nadelhalter TUC ger sp gerieft 18,0 cm	53
132 91 0220	Castroviejo jehelec zahnutý vroubkovaný tvrdokov; 18,0 cm	Castroviejo micro-needle holder TUC; 18,0 cm	Castroviejo Mikro-Nadelhalter TUC geb sp gerieft 18,0 cm	53
132 91 0221	Jacobson jehelec mikro hladký tvrdokov; 21,0 cm	Jacobson micro-needle holder TUC; 21,0 cm	Jacobson Mikro-Nadelhalter TUC sp glatt 21,0 cm	53
132 91 0222	Jacobson jehelec mikro vroubkovaný tvrdokov; 21,0 cm	Jacobson micro-needle holder TUC; 21,0 cm	Jacobson Mikro-Nadelhalter TUC sp gerieft 21,0 cm	53
132 91 0257	Castroviejo jehelec mikro rovný hladký; 14,0 cm	Castroviejo micro-needle holder; 14,0 cm	Castroviejo Nadelhalter Ger Glatt; 14,0 cm	53
132 91 0258	Castroviejo jehelec mikro zahnutý hladký; 14,0 cm	Castroviejo micro-needle holder; 14,0 cm	Castroviejo Nadelhalter Geb Glatt; 14,0 cm	53
132 91 0259	Castroviejo jehelec mikro rovný vroubkovaný; 14,0 cm	Castroviejo micro-needle holder; 14,0 cm	Castroviejo Nadelhalter Ger Gerieft; 14,0 cm	53
132 91 0260	Castroviejo jehelec mikro zahnutý vroubkovaný; 14,0 cm	Castroviejo micro-needle holder; 14,0 cm	Castroviejo Nadelhalter Geb Gerieft; 14,0 cm	53
132 91 0261	Castroviejo jehelec rovný hladký s uzávěrem; 14,0 cm	Castroviejo micro-needle holder; 14,0 cm	Castroviejo Nadelhalter Ger Sp Glatt; 14,0 cm	53
132 91 0262	Castroviejo jehelec zahnutý hladký s uzávěrem; 14,0 cm	Castroviejo micro-needle holder; 14,0 cm	Castroviejo Nadelhalter Geb Sp Glatt; 14,0 cm	53
132 91 0263	Castroviejo jehelec rovný vroubk. s uzávěrem; 14,0 cm	Castroviejo micro-needle holder; 14,0 cm	Castroviejo Nadelhalter Ger Sp Gerieft; 14,0 cm	53
132 91 0264	Castroviejo jehelec zahnutý vroubk. s uzávěrem; 14,0 cm	Castroviejo micro-needle holder; 14,0 cm	Castroviejo Nadelhalter Geb Sp Gerieft; 14,0 cm	53
133	SONDY, PÁTRADLA	PROBES	SONDEN	
133 50 0106	Sonda parodontolog. 3,5; 5,5; 8,5; 11,5 mm; 15,2 cm	Periodontal probe; 3,5; 5,5; 8,5; 11,5 mm; 15,2 cm	Parodontometer; 3,5; 5,5; 8,5; 11,5 mm; 15,2 cm	97
133 50 0116	Sonda parodontolog. 1; 2; 3; 5; 7; 9; 11; 13 mm; 15,2 cm	Periodontal probe; 2; 3; 5; 7; 9; 11; 13 mm; 15,2 cm	Parodontometer; 1; 2; 3; 5; 7; 9; 11; 13 mm; 15,2 cm	97
133 51 0010	Pátradlo zubní háčkové krátké; 15,2 cm	Dental probe; 15,2 cm	Zahnsonde mit 8kant-Griff; 15,2 cm	71
133 51 0016	Pátradlo zubní háčkové krátké; 15,2 cm	Dental probe; 15,2 cm	Zahnsonde; 15,2 cm	71
133 51 0020	Pátradlo zubní háčkové dlouhé; 15,1 cm	Dental probe; 15,1 cm	Zahnsonde mit 8kant-Griff; 15,1 cm	71
133 51 0026	Pátradlo zubní háčkové dlouhé; 15,1 cm	Dental probe; 15,1 cm	Zahnsonde; 15,1 cm	71
133 51 0030	Pátradlo zubní obloukové; 14,5 cm	Dental probe; 14,5 cm	Zahnsonde mit 8kant-Griff; 14,5 cm	71
133 51 0036	Pátradlo zubní obloukové; 14,5 cm	Dental probe; 14,5 cm	Zahnsonde; 14,5 cm	71
133 51 0040	Pátradlo zubní vyhnuté krátké; 15,0 cm	Dental probe; 15,0 cm	Zahnsonde mit 8kant-Griff; 15,0 cm	71
133 51 0046	Pátradlo zubní vyhnuté krátké; 15,0 cm	Dental probe; 15,0 cm	Zahnsonde; 15,0 cm	71
133 51 0050	Pátradlo zubní vyhnuté dlouhé; 14,0 cm	Dental probe; 14,0 cm	Zahnsonde mit 8kant-Griff; 14,0 cm	71, 74
133 51 0056	Pátradlo zubní vyhnuté dlouhé; 14,0 cm	Dental probe; 14,0 cm	Zahnsonde; 14,0 cm	71
133 51 0226	Explorer; 15,5 cm	Explorer; 15,5 cm	Sonde; 15,5 cm	97
133 58 0230	Nabers furkační sonda 3-6-9-12; 17,2 cm	Nabers furcation sonde 3-6-9-12; 17,2 cm	Nabers Furkationssonde 3-6-9-12; 17,2 cm	97
133 58 0240	Nabers furkační sonda nekalibrovaná; 17,2 cm	Nabers furcation sonde non calibrated; 17,2 cm	Nabers Furkationssonde nicht kalibrierter; 17,2 cm	97
136	NÁSTROJE SPECIÁLNÍ	SPECIAL INSTRUMENTS	SPEZIAL INSTRUMENTE	
136 39 0010	Toulec na pinzety; 9,0 cm	Quiver for tweezers; 9,0 cm	Standgefass für Pinzetten; 9,0 cm	138
136 39 0020	Toulec na podávkové kleště; 20,0 cm	Quiver for forceps; 20,0 cm	Standgefass für Zangen; 20,0 cm	138
136 39 0030	Toulec na pinzety; 9,0 cm	Quiver for tweezers; 9,0 cm	Standgefass für Pinzetten; 9,0 cm	138
136 39 0040	Toulec na podávkové kleště; 20,0 cm	Quiver for forceps; 20,0 cm	Standgefass für Zangen; 20,0 cm	138
136 39 0110	Táček dentální; 180×120×15 mm	Dental tray; 180×120×15 mm	Dentalplatte; 180×120×15 mm	141
136 39 0140	Krabička sterilizační; nerez; 200×100×30 mm	Sterilization box; 200×100×30mm	Sterilisierdose; 200×100×30mm	139
136 39 0150	Krabička sterilizační; nerez; 170×70×30 mm	Sterilization box; 170×70×30 mm	Sterilisierdose; 170×70×30 mm	139
136 39 0160	Krabička sterilizační; nerez; 200×100×40 mm	Sterilization box; 200×100×40 mm	Sterilisierdose; 200×100×40 mm	139
136 39 0170	Krabička s rovným víkem/úch.; nerez; 210×115×45 mm	Box; 210×115×45 mm	Dose; 210×115×45 mm	140
136 39 0180	Krabička s příhradkami dvojití víčko; 210×110×25 mm	Box; 210×110×25 mm	Dose; 210×110×25 mm	140
136 39 0190	Krabička s vypouklým víčkem; 210×115×45 mm	Box; 210×115×45 mm	Dose; 210×115×45 mm	140
136 39 0200	Krabička na katetry, víčko s úch.; nerez; 300×80×40 mm	Box; 300×80×40 mm	Dose; 300×80×40 mm	140
136 39 0210	Krabička s bočními prohlubněmi; nerez; 92×40×17 mm	Box; 92×40×17 mm	Dose; 92×40×17 mm	142
136 39 0220	Krabička s poklopem a úchytem; nerez; 350×90×50 mm	Box; 350×90×50 mm	Dose; 350×90×50 mm	140
136 39 0230	Krabička s poklopem a úchytem; nerez; 230×150×60 mm	Box; 230×150×60 mm	Dose; 230×150×60 mm	140
136 39 0240	Krabička s poklopem a rov.úch.; nerez; 300×200×50 mm	Box; 300×200×50 mm	Dose; 300×200×50 mm	140
136 39 0250	Krabička s poklopem a rov. úch.; nerez; 200×150×45 mm	Box; 200×150×45 mm	Dose; 200×150×45 mm	140
136 39 0260	Nádobka oválná – emitní miska; nerez; 175×100×25 mm	Bowl; 175×100×25 mm	Schüssel; 175×100×25 mm	139
136 39 0270	Nádobka kovová; nerez; 90×40 mm	Bowl; 90×40 mm	Schüssel; 90×40 mm	139
136 39 0320	Nádobka medicínská kovová; 82×30 mm	Bowl; 82×30 mm	Schüssel; 82×30 mm	139
136 39 0330	Táček; nerez; 200×100×10 mm	Tray; 200×100×10 mm	Platte; 200×100×10 mm	141
136 39 0340	Táček s drážkami; nerez; 190×100×17 mm	Tray; 200×100×17 mm	Platte; 200×100×17 mm	141
136 39 0350	Táček hluboký; nerez; 200×100×30 mm	Tray; 200×100×30 mm	Platte; 200×100×30 mm	141
136 39 0360	Táček; nerez; 190×100×10 mm	Tray; 190×100×10 mm	Platte; 190×100×10 mm	141
136 39 0370	Táček; nerez; 280×190×20 mm	Tray; 280×190×20 mm	Platte; 280×190×20 mm	141
136 39 0380	Táček; nerez; 350×250×20 mm	Tray; 350×250×20 mm	Platte; 350×250×20 mm	141
136 39 0410	Krabička na umělý chrup; 80×80×40 mm	Box for denture; 80×80×40 mm	Dose für Zahnprothese; 80×80×40 mm	142
136 91 0001	Langenbeck chránič prstu	Langenbeck finger protector	Langenbeck Fingerschützer	37
136 91 0002	Langenbeck chránič prstu	Langenbeck finger protector	Langenbeck Fingerschützer	37

číslo – number	název	item	Artikel	strana – page
136 91 0003	Langenbeck chránič prstu	Langenbeck finger protector	Langenbeck Fingerschützer	37
136 91 0259	Kontejner; 285×280×100 mm; stříbrný	Container; 285×280×100 mm; silver	Container; 285×280×100 mm; silber	144
136 91 0260	Kontejner; 285×280×100 mm; modrý	Container; 285×280×100 mm; blue	Container; 285×280×100 mm; blau	144
136 91 0261	Kontejner; 285×280×100 mm; červený	Container; 285×280×100 mm; red	Container; 285×280×100 mm; rot	144
136 91 0262	Kontejner; 285×280×100 mm; zelený	Container; 285×280×100 mm; green	Container; 285×280×100 mm; grün	144
136 91 0263	Kontejner; 285×280×100 mm; zlatý	Container; 285×280×100 mm; gold	Container; 285×280×100 mm; gold	144
136 91 0264	Kontejner; 285×280×100 mm; černý	Container; 285×280×100 mm; black	Container; 285×280×100 mm; schwarz	144
136 91 0265	Kontejner; 285×280×135 mm; stříbrný	Container; 285×280×135 mm; silver	Container; 285×280×135 mm; silber	144
136 91 0266	Kontejner; 285×280×135 mm; modrý	Container; 285×280×135 mm; blue	Container; 285×280×135 mm; blau	144
136 91 0267	Kontejner; 285×280×135 mm; červený	Container; 285×280×135 mm; red	Container; 285×280×135 mm; rot	144
136 91 0268	Kontejner; 285×280×135 mm; zelený	Container; 285×280×135 mm; green	Container; 285×280×135 mm; grün	144
136 91 0269	Kontejner; 285×280×135 mm; zlatý	Container; 285×280×135 mm; gold	Container; 285×280×135 mm; gold	144
136 91 0270	Kontejner; 285×280×135 mm; černý	Container; 285×280×135 mm; black	Container; 285×280×135 mm; schwarz	144
136 91 0271	Kontejner; 285×280×150 mm; stříbrný	Container; 285×280×150 mm; silver	Container; 285×280×150 mm; silber	144
136 91 0272	Kontejner; 285×280×150 mm; modrý	Container; 285×280×150 mm; blue	Container; 285×280×150 mm; blau	144
136 91 0273	Kontejner; 285×280×150 mm; červený	Container; 285×280×150 mm; red	Container; 285×280×150 mm; rot	144
136 91 0274	Kontejner; 285×280×150 mm; zelený	Container; 285×280×150 mm; green	Container; 285×280×150 mm; grün	144
136 91 0275	Kontejner; 285×280×150 mm; zlatý	Container; 285×280×150 mm; gold	Container; 285×280×150 mm; gold	144
136 91 0276	Kontejner; 285×280×150 mm; černý	Container; 285×280×150 mm; black	Container; 285×280×150 mm; schwarz	144
136 91 0277	Kontejner; 285×280×200 mm; stříbrný	Container; 285×280×200 mm; silver	Container; 285×280×200 mm; silber	144
136 91 0278	Kontejner; 285×280×200 mm; modrý	Container; 285×280×200 mm; blue	Container; 285×280×200 mm; blau	144
136 91 0279	Kontejner; 285×280×200 mm; červený	Container; 285×280×200 mm; red	Container; 285×280×200 mm; rot	144
136 91 0280	Kontejner; 285×280×200 mm; zelený	Container; 285×280×200 mm; green	Container; 285×280×200 mm; grün	144
136 91 0281	Kontejner; 285×280×200 mm; stříbrný	Container; 285×280×200 mm; gold	Container; 285×280×200 mm; gold	144
136 91 0282	Kontejner; 285×280×200 mm; černý	Container; 285×280×200 mm; black	Container; 285×280×200 mm; schwarz	144
136 91 0283	Kontejner; 285×280×260 mm; stříbrný	Container; 285×280×260 mm; silver	Container; 285×280×260 mm; silber	144
136 91 0284	Kontejner; 285×280×260 mm; modrý	Container; 285×280×260 mm; blue	Container; 285×280×260 mm; blau	144
136 91 0285	Kontejner; 285×280×260 mm; červený	Container; 285×280×260 mm; red	Container; 285×280×260 mm; rot	144
136 91 0286	Kontejner; 285×280×260 mm; zelený	Container; 285×280×260 mm; green	Container; 285×280×260 mm; grün	144
136 91 0287	Kontejner; 285×280×260 mm; zlatý	Container; 285×280×260 mm; gold	Container; 285×280×260 mm; gold	144
136 91 0288	Kontejner; 285×280×260 mm; černý	Container; 285×280×260 mm; black	Container; 285×280×260 mm; schwarz	144
136 91 0337	Kontejner; 285×280×100 mm; stříbrný	Container; 285×280×100 mm; silver	Container; 285×280×100 mm; silber	144
136 91 0338	Kontejner; 285×280×100 mm; modrý	Container; 285×280×100 mm; blue	Container; 285×280×100 mm; blau	144
136 91 0339	Kontejner; 285×280×100 mm; červený	Container; 285×280×100 mm; red	Container; 285×280×100 mm; rot	144
136 91 0340	Kontejner; 285×280×100 mm; zelený	Container; 285×280×100 mm; green	Container; 285×280×100 mm; grün	144
136 91 0341	Kontejner; 285×280×100 mm; zlatý	Container; 285×280×100 mm; gold	Container; 285×280×100 mm; gold	144
136 91 0342	Kontejner; 285×280×100 mm; černý	Container; 285×280×100 mm; black	Container; 285×280×100 mm; schwarz	144
136 91 0343	Kontejner; 285×280×135 mm; stříbrný	Container; 285×280×135 mm; silver	Container; 285×280×135 mm; silber	144
136 91 0344	Kontejner; 285×280×135 mm; modrý	Container; 285×280×135 mm; blue	Container; 285×280×135 mm; blau	144
136 91 0345	Kontejner; 285×280×135 mm; červený	Container; 285×280×135 mm; red	Container; 285×280×135 mm; rot	144
136 91 0346	Kontejner; 285×280×135 mm; zelený	Container; 285×280×135 mm; green	Container; 285×280×135 mm; grün	144
136 91 0347	Kontejner; 285×280×135 mm; zlatý	Container; 285×280×135 mm; gold	Container; 285×280×135 mm; gold	144
136 91 0348	Kontejner; 285×280×135 mm; černý	Container; 285×280×135 mm; black	Container; 285×280×135 mm; schwarz	144
136 91 0349	Kontejner; 285×280×150 mm; stříbrný	Container; 285×280×150 mm; silver	Container; 285×280×150 mm; silber	144
136 91 0350	Kontejner; 285×280×150 mm; modrý	Container; 285×280×150 mm; blue	Container; 285×280×150 mm; blau	144
136 91 0351	Kontejner; 285×280×150 mm; červený	Container; 285×280×150 mm; red	Container; 285×280×150 mm; rot	144
136 91 0352	Kontejner; 285×280×150 mm; zelený	Container; 285×280×150 mm; green	Container; 285×280×150 mm; grün	144
136 91 0353	Kontejner; 285×280×150 mm; zlatý	Container; 285×280×150 mm; gold	Container; 285×280×150 mm; gold	144
136 91 0354	Kontejner; 285×280×150 mm; černý	Container; 285×280×150 mm; black	Container; 285×280×150 mm; schwarz	144
136 91 0355	Kontejner; 285×280×200 mm; stříbrný	Container; 285×280×200 mm; silver	Container; 285×280×200 mm; silber	144
136 91 0356	Kontejner; 285×280×200 mm; modrý	Container; 285×280×200 mm; blue	Container; 285×280×200 mm; blau	144
136 91 0357	Kontejner; 285×280×200 mm; červený	Container; 285×280×200 mm; red	Container; 285×280×200 mm; rot	144
136 91 0358	Kontejner; 285×280×200 mm; zelený	Container; 285×280×200 mm; green	Container; 285×280×200 mm; grün	144
136 91 0359	Kontejner; 285×280×200 mm; zlatý	Container; 285×280×200 mm; gold	Container; 285×280×200 mm; gold	144
136 91 0360	Kontejner; 285×280×200 mm; černý	Container; 285×280×200 mm; black	Container; 285×280×200 mm; schwarz	144
136 91 0361	Kontejner; 285×280×260 mm; stříbrný	Container; 285×280×260 mm; silver	Container; 285×280×260 mm; silber	144
136 91 0362	Kontejner; 285×280×260 mm; modrý	Container; 285×280×260 mm; blue	Container; 285×280×260 mm; blau	144
136 91 0363	Kontejner; 285×280×260 mm; červený	Container; 285×280×260 mm; red	Container; 285×280×260 mm; rot	144
136 91 0364	Kontejner; 285×280×260 mm; zelený	Container; 285×280×260 mm; green	Container; 285×280×260 mm; grün	144
136 91 0365	Kontejner; 285×280×260 mm; zlatý	Container; 285×280×260 mm; gold	Container; 285×280×260 mm; gold	144
136 91 0366	Kontejner; 285×280×260 mm; černý	Container; 285×280×260 mm; black	Container; 285×280×260 mm; schwarz	144
136 91 0415	Viko perforované; 285×280 mm; stříbrné	Lid perforated; 285×280 mm; silver	Deckel gelocht; 285×280 mm; silber	144
136 91 0416	Viko perforované; 285×280 mm; modré	Lid perforated; 285×280 mm; blue	Deckel gelocht; 285×280 mm; blau	144
136 91 0417	Viko perforované; 285×280 mm; červené	Lid perforated; 285×280 mm; red	Deckel gelocht; 285×280 mm; rot	144
136 91 0418	Viko perforované; 285×280 mm; zelené	Lid perforated; 285×280 mm; green	Deckel gelocht; 285×280 mm; grün	144
136 91 0419	Viko perforované; 285×280 mm; zlaté	Lid perforated; 285×280 mm; gold	Deckel gelocht; 285×280 mm; gold	144
136 91 0420	Viko perforované; 285×280 mm; černé	Lid perforated; 285×280 mm; black	Deckel gelocht; 285×280 mm; schwarz	144
136 91 0438	Viko ochranné; 285×280 mm; stříbrné	Safety lid; 285×280 mm; silver	Sicherheitsdeckel; 285×280 mm; silber	144
136 91 0439	Viko ochranné; 285×280 mm; modré	Safety lid; 285×280 mm; blue	Sicherheitsdeckel; 285×280 mm; blau	144
136 91 0440	Viko ochranné; 285×280 mm; červené	Safety lid; 285×280 mm; red	Sicherheitsdeckel; 285×280 mm; rot	144
136 91 0441	Viko ochranné; 285×280 mm; zelené	Safety lid; 285×280 mm; green	Sicherheitsdeckel; 285×280 mm; grün	144
136 91 0442	Viko ochranné; 285×280 mm; zlaté	Safety lid; 285×280 mm; gold	Sicherheitsdeckel; 285×280 mm; gold	144
136 91 0443	Viko ochranné; 285×280 mm; černé	Safety lid; 285×280 mm; black	Sicherheitsdeckel; 285×280 mm; schwarz	144
136 91 0463	Vana perforovaná; 285×280×100 mm	Bottom perforated; 285×280×100 mm	Boden gelocht; 285×280×100 mm	144
136 91 0464	Vana perforovaná; 285×280×135 mm	Bottom perforated; 285×280×135 mm	Boden gelocht; 285×280×135 mm	144
136 91 0465	Vana perforovaná; 285×280×150 mm	Bottom perforated; 285×280×150 mm	Boden gelocht; 285×280×150 mm	144
136 91 0466	Vana perforovaná; 285×280×200 mm	Bottom perforated; 285×280×200 mm	Boden gelocht; 285×280×200 mm	144
136 91 0467	Vana perforovaná; 285×280×260 mm	Bottom perforated; 285×280×260 mm	Boden gelocht; 285×280×260 mm	144
136 91 0475	Vana neperforovaná; 285×280×100 mm	Bottom non-perforated; 285×280×100 mm	Boden ungelocht; 285×280×100 mm	144
136 91 0476	Vana neperforovaná; 285×280×135 mm	Bottom non-perforated; 285×280×135 mm	Boden ungelocht; 285×280×135 mm	144
136 91 0477	Vana neperforovaná; 285×280×150 mm	Bottom non-perforated; 285×280×150 mm	Boden ungelocht; 285×280×150 mm	144

číslo – number	název	item	Artikel	strana – page
136 91 0478	Vana neperforovaná; 285×280×200 mm	Bottom non-perforated; 285×280×200 mm	Boden ungelocht; 285×280×200 mm	144
136 91 0479	Vana neperforovaná; 285×280×260 mm	Bottom non-perforated; 285×280×260 mm	Boden ungelocht; 285×280×260 mm	144
136 91 0485	Viko perforované; 300×140 mm; stříbrné	Lid perforated; 300×140 mm; silver	Deckel gelocht; 300×140 mm; silber	146
136 91 0486	Viko perforované; 300×140 mm; modré	Lid perforated; 300×140 mm; blue	Deckel gelocht; 300×140 mm; blau	146
136 91 0487	Viko perforované; 300×140 mm; červené	Lid perforated; 300×140 mm; red	Deckel gelocht; 300×140 mm; rot	146
136 91 0488	Viko perforované; 300×140 mm; zelené	Lid perforated; 300×140 mm; green	Deckel gelocht; 300×140 mm; grün	146
136 91 0489	Viko perforované; 300×140 mm; zlaté	Lid perforated; 300×140 mm; gold	Deckel gelocht; 300×140 mm; gold	146
136 91 0490	Viko neperforované; 285×280 mm; stříbrné	Lid non-perforated; 285×280 mm; silver	Deckel geschlossen; 285×280 mm; silber	144
136 91 0491	Viko neperforované; 285×280 mm; modré	Lid non-perforated; 285×280 mm; blue	Deckel geschlossen; 285×280 mm; blau	144
136 91 0492	Viko neperforované; 285×280 mm; červené	Lid non-perforated; 285×280 mm; red	Deckel geschlossen; 285×280 mm; rot	144
136 91 0493	Viko neperforované; 285×280 mm; zelené	Lid non-perforated; 285×280 mm; green	Deckel geschlossen; 285×280 mm; grün	144
136 91 0494	Viko neperforované; 285×280 mm; zlaté	Lid non-perforated; 285×280 mm; gold	Deckel geschlossen; 285×280 mm; gold	144
136 91 0495	Viko neperforované; 285×280 mm; černé	Lid non-perforated; 285×280 mm; black	Deckel geschlossen; 285×280 mm; schwarz	144
136 91 0513	Viko neperforované; 300×140 mm; stříbrné	Lid non-perforated; 300×140 mm; silver	Deckel geschlossen; 300×140 mm; silber	146
136 91 0514	Viko neperforované; 300×140 mm; modré	Lid non-perforated; 300×140 mm; blue	Deckel geschlossen; 300×140 mm; blau	146
136 91 0515	Viko neperforované; 300×140 mm; červené	Lid non-perforated; 300×140 mm; red	Deckel geschlossen; 300×140 mm; rot	146
136 91 0516	Viko neperforované; 300×140 mm; zelené	Lid non-perforated; 300×140 mm; green	Deckel geschlossen; 300×140 mm; grün	146
136 91 0517	Viko neperforované; 300×140 mm; zlaté	Lid non-perforated; 300×140 mm; gold	Deckel geschlossen; 300×140 mm; gold	146
136 91 0526	Koš síťový; 255×245×30 mm	Wire basket; 255×245×30 mm	Siebcorp; 255×245×30 mm	144
136 91 0527	Koš síťový; 255×245×50 mm	Wire basket; 255×245×50 mm	Siebcorp; 255×245×50 mm	144
136 91 0528	Koš síťový; 255×245×70 mm	Wire basket; 255×245×70 mm	Siebcorp; 255×245×70 mm	144
136 91 0529	Koš síťový; 255×245×100 mm	Wire basket; 255×245×100 mm	Siebcorp; 255×245×100 mm	144
136 91 0534	Filtr standardní papírový; 100 ks	Paper filters standard; 100 pieces	Filter, Papier, 100 Stück, Standard	147
136 91 0535	Filtr standardní textilní; 1 ks	Textile filter standard; 1 piece	Filter, Textil, 1 Stück, Standard	147
136 91 0536	Filtr mini papírový; 100 ks	Paper filters small; 100 pieces	Filter, Papier, 100 Stück, Klein	147
136 91 0537	Filtr mini textilní; 1ks	Textile filter mini; 1 piece	Filter, Textil, 1 Stück, Mini	147
136 91 0540	Štítek identifikační papírový standardní; 100 ks	Paper label with indicator; 100 pieces	Indikatorschilder aus Papier; 100 Stück	147
136 91 0541	Štítek identifikační papírový malý; 100 ks	Paper label with indicator; 100 pieces	Indikatorschilder aus Papier; 100 Stück	147
136 91 0542	Zámek bezpečnostní plastový; 100 ks	Plastic security seal; 100 pieces	Sicherheitsverschluss Plastik; 100 Stück	147
136 91 0543	Štítek identifikační; stříbrný	Identification label blank; silver	Kennzeichnungsschilder Ungraviert; silber	147
136 91 0544	Štítek identifikační; zlatý	Identification label blank; golden	Kennzeichnungsschilder Ungraviert; golden	147
136 91 0545	Štítek identifikační; červený	Identification label blank; red	Kennzeichnungsschilder Ungraviert; rot	147
136 91 0546	Štítek identifikační; modrý	Identification label blank; blue	Kennzeichnungsschilder Ungraviert; blau	147
136 91 0547	Štítek identifikační; zelený	Identification label blank; green	Kennzeichnungsschilder Ungraviert; grün	147
136 91 0548	Štítek identifikační; černý	Identification label blank; black	Kennzeichnungsschilder Ungraviert; schwarz	147
136 91 0550	Štítek identifikační pro text; stříbrný	Identification label engrave; silver	Kennzeichnungsschilder Graviert; silber	147
136 91 0551	Štítek identifikační pro text; zlatý	Identification label engrave; golden	Kennzeichnungsschilder Graviert; golden	147
136 91 0552	Štítek identifikační pro text; červený	Identification label engrave; red	Kennzeichnungsschilder Graviert; rot	147
136 91 0553	Štítek identifikační pro text; modrý	Identification label engrave; blue	Kennzeichnungsschilder Graviert; blau	147
136 91 0554	Štítek identifikační pro text; zelený	Identification label engrave; green	Kennzeichnungsschilder Graviert; grün	147
136 91 0555	Štítek identifikační pro text; černý	Identification label engrave; black	Kennzeichnungsschilder Graviert; schwarz	147
136 91 0569	Kontejner mini; 300×140×40 mm; stříbrný	Small set container; 300×140×40 mm; silver	Klein set container; 300×140×40 mm; silber	146
136 91 0570	Kontejner mini; 300×140×40 mm; modrý	Small set container; 300×140×40 mm; blue	Klein set container; 300×140×40 mm; blau	146
136 91 0571	Kontejner mini; 300×140×40 mm; červený	Small set container; 300×140×40 mm; red	Klein set container; 300×140×40 mm; rot	146
136 91 0572	Kontejner mini; 300×140×40 mm; zelený	Small set container; 300×140×40 mm; green	Klein set container; 300×140×40 mm; grün	146
136 91 0573	Kontejner mini; 300×140×40 mm; zlatý	Small set container; 300×140×40 mm; gold	Klein set container; 300×140×40 mm; gold	146
136 91 0574	Kontejner mini; 300×140×70 mm; stříbrný	Small set container; 300×140×70 mm; silver	Klein set container; 300×140×70 mm; silber	146
136 91 0575	Kontejner mini; 300×140×70 mm; modrý	Small set container; 300×140×70 mm; blue	Klein set container; 300×140×70 mm; blau	146
136 91 0576	Kontejner mini; 300×140×70 mm; červený	Small set container; 300×140×70 mm; red	Klein set container; 300×140×70 mm; rot	146
136 91 0577	Kontejner mini; 300×140×70 mm; zelený	Small set container; 300×140×70 mm; green	Klein set container; 300×140×70 mm; grün	146
136 91 0578	Kontejner mini; 300×140×70 mm; zlatý	Small set container; 300×140×70 mm; gold	Klein set container; 300×140×70 mm; gold	146
136 91 0579	Kontejner mini; 300×140×100 mm; stříbrný	Small set container; 300×140×100 mm; silver	Klein set container; 300×140×100 mm; silber	146
136 91 0580	Kontejner mini; 300×140×100 mm; modrý	Small set container; 300×140×100 mm; blue	Klein set container; 300×140×100 mm; blau	146
136 91 0581	Kontejner mini; 300×140×100 mm; červený	Small set container; 300×140×100 mm; red	Klein set container; 300×140×100 mm; rot	146
136 91 0582	Kontejner mini; 300×140×100 mm; zelený	Small set container; 300×140×100 mm; green	Klein set container; 300×140×100 mm; grün	146
136 91 0583	Kontejner mini; 300×140×100 mm; zlatý	Small set container; 300×140×100 mm; gold	Klein set container; 300×140×100 mm; gold	146
136 91 0584	Kontejner mini; 300×140×40 mm; stříbrný	Small set container; 300×140×40 mm; silver	Klein set container; 300×140×40 mm; silber	146
136 91 0585	Kontejner mini; 300×140×40 mm; modrý	Small set container; 300×140×40 mm; blue	Klein set container; 300×140×40 mm; blau	146
136 91 0586	Kontejner mini; 300×140×40 mm; červený	Small set container; 300×140×40 mm; red	Klein set container; 300×140×40 mm; rot	146
136 91 0587	Kontejner mini; 300×140×40 mm; zelený	Small set container; 300×140×40 mm; green	Klein set container; 300×140×40 mm; grün	146
136 91 0588	Kontejner mini; 300×140×40 mm; zlatý	Small set container; 300×140×40 mm; gold	Klein set container; 300×140×40 mm; gold	146
136 91 0589	Kontejner mini; 300×140×70 mm; stříbrný	Small set container; 300×140×70 mm; silver	Klein set container; 300×140×70 mm; silber	146
136 91 0590	Kontejner mini; 300×140×70 mm; modrý	Small set container; 300×140×70 mm; blue	Klein set container; 300×140×70 mm; blau	146
136 91 0591	Kontejner mini; 300×140×70 mm; červený	Small set container; 300×140×70 mm; red	Klein set container; 300×140×70 mm; rot	146
136 91 0592	Kontejner mini; 300×140×70 mm; zelený	Small set container; 300×140×70 mm; green	Klein set container; 300×140×70 mm; grün	146
136 91 0593	Kontejner mini; 300×140×70 mm; zlatý	Small set container; 300×140×70 mm; gold	Klein set container; 300×140×70 mm; gold	146
136 91 0594	Kontejner mini; 300×140×100 mm; stříbrný	Small set container; 300×140×100 mm; silver	Klein set container; 300×140×100 mm; silber	146
136 91 0595	Kontejner mini; 300×140×100 mm; modrý	Small set container; 300×140×100 mm; blue	Klein set container; 300×140×100 mm; blau	146
136 91 0596	Kontejner mini; 300×140×100 mm; červený	Small set container; 300×140×100 mm; red	Klein set container; 300×140×100 mm; rot	146
136 91 0597	Kontejner mini; 300×140×100 mm; zelený	Small set container; 300×140×100 mm; green	Klein set container; 300×140×100 mm; grün	146
136 91 0598	Kontejner mini; 300×140×100 mm; zlatý	Small set container; 300×140×100 mm; gold	Klein set container; 300×140×100 mm; gold	146
136 91 0599	Vana perforovaná; 300×140×40 mm	Bottom perforated; 300×140×40 mm	Boden gelocht; 300×140×40 mm	146
136 91 0600	Vana perforovaná; 300×140×70 mm	Bottom perforated; 300×140×70 mm	Boden gelocht; 300×140×70 mm	146
136 91 0601	Vana perforovaná; 300×140×100 mm	Bottom perforated; 300×140×100 mm	Boden gelocht; 300×140×100 mm	146
136 91 0602	Vana neperforovaná; 300×140×40 mm	Bottom non-perforated; 300×140×40 mm	Boden ungelocht; 300×140×40 mm	146
136 91 0603	Vana neperforovaná; 300×140×70 mm	Bottom non-perforated; 300×140×70 mm	Boden ungelocht; 300×140×70 mm	146
136 91 0604	Vana neperforovaná; 300×140×100 mm	Bottom non-perforated; 300×140×100 mm	Boden ungelocht; 300×140×100 mm	146
136 91 0619	Rouška textilní zelená; 60×40 cm	Cloth green; 60×40 cm	Tuch Grün; 60×40 cm	148
136 91 0620	Rouška textilní zelená; 85×85 cm	Cloth green; 85×85 cm	Tuch Grün; 85×85 cm	148
136 91 0621	Rouška textilní zelená; 100×140 cm	Cloth green; 100×140 cm	Tuch Grün; 100×140 cm	148
136 91 0622	Rouška textilní zelená; 275×125 cm	Cloth green; 275×125 cm	Tuch Grün; 275×125 cm	148

číslo – number	název	item	Artikel	strana – page
136 91 0623	Rouška textilní zelená; 245×245 cm	Cloth green; 245×245 cm	Tuch Grün; 245×245 cm	148
136 91 0624	Podložka silikonová; 275×125 mm	Silicon mat; 275×125 mm	Noppenmatte Silikon; 275×125 mm	148
136 91 0625	Podložka silikonová; 225×225 mm	Silicon mat; 225×225 mm	Noppenmatte Silikon; 225×225 mm	148
136 91 0626	Podložka silikonová; 300×300 mm	Silicon mat; 300×300 mm	Noppenmatte Silikon; 300×300 mm	148
136 91 0635	Filtr teflonový standardní; 1 ks	Teflon filter standard; 1 piece	Filter, Teflon, 1 Stück, Standard	147
136 91 0645	Víko perforované; 310×190 mm; stříbrné	Lid perforated; 310×190 mm; silver	Deckel gelocht; 310×190 mm; silber	145
136 91 0646	Víko perforované; 310×190 mm; modré	Lid perforated; 310×190 mm; blue	Deckel gelocht; 310×190 mm; blau	145
136 91 0647	Víko perforované; 310×190 mm; červené	Lid perforated; 310×190 mm; red	Deckel gelocht; 310×190 mm; rot	145
136 91 0648	Víko perforované; 310×190 mm; zelené	Lid perforated; 310×190 mm; green	Deckel gelocht; 310×190 mm; grün	145
136 91 0649	Víko perforované; 310×190 mm; zlaté	Lid perforated; 310×190 mm; gold	Deckel gelocht; 310×190 mm; gold	145
136 91 0650	Víko perforované; 310×190 mm; černé	Lid perforated; 310×190 mm; black	Deckel gelocht; 310×190 mm; schwarz	145
136 91 0652	Víko perforované; 300×140 mm; černé	Lid perforated; 300×140 mm; black	Deckel gelocht; 300×140 mm; schwarz	146
136 91 0653	Víko neperforované; 310×190 mm; stříbrné	Lid non perforated; 310×190 mm; silver	Deckel geschlossen; 310×190 mm; silber	145
136 91 0654	Víko neperforované; 310×190 mm; modré	Lid non perforated; 310×190 mm; blue	Deckel geschlossen; 310×190 mm; blau	145
136 91 0655	Víko neperforované; 310×190 mm; červené	Lid non perforated; 310×190 mm; red	Deckel geschlossen; 310×190 mm; rot	145
136 91 0656	Víko neperforované; 310×190 mm; zelené	Lid non perforated; 310×190 mm; green	Deckel geschlossen; 310×190 mm; grün	145
136 91 0657	Víko neperforované; 310×190 mm; zlaté	Lid non perforated; 310×190 mm; gold	Deckel geschlossen; 310×190 mm; gold	145
136 91 0658	Víko neperforované; 310×190 mm; černé	Lid non perforated; 310×190 mm; black	Deckel geschlossen; 310×190 mm; schwarz	145
136 91 0659	Víko neperforované; 300×140 mm; černé	Lid non perforated; 300×140 mm; black	Deckel geschlossen; 300×140 mm; schwarz	146
136 91 0660	Vložka síťová; 270×125 mm	Wire base; 270×125 mm	Siebelinlage; 270×125 mm	146
136 91 0661	Koš síťový; 267×125×50 mm	Wire basket; 267×125×50 mm	Siebkorb; 267×125×50 mm	146
136 91 0662	Koš síťový; 274×172×43 mm	Wire basket; 274×172×43 mm	Siebkorb; 274×172×43 mm	145
136 91 0667	Rám napínací jednoduchý 255×255 mm	Drape retainer single 255×255 mm	Spannrahmen einfach 255×255 mm	144
136 91 0668	Rám napínací 255×255 mm	Drape retainer double 255×255 mm	Spannrahmen 255×255 mm	144
136 91 0669	Rám napínací dentální; 270×170 mm	Drape retainer dental; 270×170 mm	Spannrahmen einfach dental; 270×170 mm	145
136 91 0670	Rám napínací malý; 270×125 mm	Drape retainer small; 270×125 mm	Spannrahmen einfach klein; 270×125 mm	146
136 91 0675	Síto oddělovací; 255×245×130 mm	Divider; 255×245×130 mm	Teiler; 255×245×130 mm	144
136 91 0676	Filtr dentální papírový; 100 ks	Filter; paper; 100 pieces; dental	Filter, Papier, 100 Stück, Dental	147
136 91 0677	Filtr dentální textilní; 1 ks	Filter; textile; 1 piece; dental	Filter, Textil, 1 Stück, Dental	147
136 91 0684	Kontejner mini; 300×140×40mm; černý	Small set container; 300×140×40mm; black	Klein set container; 300×140×40mm; schwarz	146
136 91 0685	Kontejner mini; 300×140×70mm; černý	Small set container; 300×140×70mm; black	Klein set container; 300×140×70mm; schwarz	146
136 91 0686	Kontejner mini; 300×140×100mm; černý	Small set container; 300×140×100mm; black	Klein set container; 300×140×100mm; schwarz	146
136 91 0687	Kontejner mini; 300×140×40mm; černý	Small set container; 300×140×40mm; black	Klein set container; 300×140×40mm; schwarz	146
136 91 0688	Kontejner mini; 300×140×70mm; černý	Small set container; 300×140×70mm; black	Klein set container; 300×140×70mm; schwarz	146
136 91 0689	Kontejner mini; 300×140×100mm; černý	Small set container; 300×140×100mm; black	Klein set container; 300×140×100mm; schwarz	146
136 91 0690	Vana perforovaná; 310×190×40 mm	Bottom perforated; 310×190×40 mm	Boden gelocht; 310×190×40 mm	145
136 91 0691	Vana perforovaná; 310×190×65 mm	Bottom perforated; 310×190×65 mm	Boden gelocht; 310×190×65 mm	145
136 91 0692	Vana perforovaná; 310×190×130 mm	Bottom perforated; 310×190×130 mm	Boden gelocht; 310×190×130 mm	145
136 91 0693	Vana neperforovaná; 310×190×40 mm	Bottom non perforated; 310×190×40 mm	Boden ungelocht; 310×190×40 mm	145
136 91 0694	Vana neperforovaná; 310×190×65 mm	Bottom non perforated; 310×190×65 mm	Boden ungelocht; 310×190×65 mm	145
136 91 0695	Vana neperforovaná; 310×190×130 mm	Bottom non perforated; 310×190×130 mm	Boden ungelocht; 310×190×130 mm	145
136 91 0696	Kontejner dentální; 310×190×40 mm; stříbrný	Dental container; 310×190×40 mm; silver	Dental container; 310×190×40 mm; silber	145
136 91 0697	Kontejner dentální; 310×190×40 mm; modrý	Dental container; 310×190×40 mm; blue	Dental container; 310×190×40 mm; blau	145
136 91 0698	Kontejner dentální; 310×190×40 mm; červený	Dental container; 310×190×40 mm; red	Dental container; 310×190×40 mm; rot	145
136 91 0699	Kontejner dentální; 310×190×40 mm; zelený	Dental container; 310×190×40 mm; green	Dental container; 310×190×40 mm; grün	145
136 91 0700	Kontejner dentální; 310×190×40 mm; zlatý	Dental container; 310×190×40 mm; gold	Dental container; 310×190×40 mm; gold	145
136 91 0701	Kontejner dentální; 310×190×40 mm; černý	Dental container; 310×190×40 mm; black	Dental container; 310×190×40 mm; schwarz	145
136 91 0702	Kontejner dentální; 310×190×65 mm; stříbrný	Dental container; 310×190×65 mm; silver	Dental container; 310×190×65 mm; silber	145
136 91 0703	Kontejner dentální; 310×190×65 mm; modrý	Dental container; 310×190×65 mm; blue	Dental container; 310×190×65 mm; blau	145
136 91 0704	Kontejner dentální; 310×190×65 mm; červený	Dental container; 310×190×65 mm; red	Dental container; 310×190×65 mm; rot	145
136 91 0705	Kontejner dentální; 310×190×65 mm; zelený	Dental container; 310×190×65 mm; green	Dental container; 310×190×65 mm; grün	145
136 91 0706	Kontejner dentální; 310×190×65 mm; zlatý	Dental container; 310×190×65 mm; gold	Dental container; 310×190×65 mm; gold	145
136 91 0707	Kontejner dentální; 310×190×65 mm; černý	Dental container; 310×190×65 mm; black	Dental container; 310×190×65 mm; schwarz	145
136 91 0708	Kontejner dentální; 310×190×130 mm; stříbrný	Dental container; 310×190×130 mm; silver	Dental container; 310×190×130 mm; silber	145
136 91 0709	Kontejner dentální; 310×190×130 mm; modrý	Dental container; 310×190×130 mm; blue	Dental container; 310×190×130 mm; blau	145
136 91 0710	Kontejner dentální; 310×190×130 mm; červený	Dental container; 310×190×130 mm; red	Dental container; 310×190×130 mm; rot	145
136 91 0711	Kontejner dentální; 310×190×130 mm; zelený	Dental container; 310×190×130 mm; green	Dental container; 310×190×130 mm; grün	145
136 91 0712	Kontejner dentální; 310×190×130 mm; zlatý	Dental container; 310×190×130 mm; gold	Dental container; 310×190×130 mm; gold	145
136 91 0713	Kontejner dentální; 310×190×130 mm; černý	Dental container; 310×190×130 mm; black	Dental container; 310×190×130 mm; schwarz	145
136 91 0714	Kontejner dentální; 310×190×40 mm; stříbrný	Dental container; 310×190×40 mm; silver	Dental container; 310×190×40 mm; silber	145
136 91 0715	Kontejner dentální; 310×190×40 mm; modrý	Dental container; 310×190×40 mm; blue	Dental container; 310×190×40 mm; blau	145
136 91 0716	Kontejner dentální; 310×190×40 mm; červený	Dental container; 310×190×40 mm; red	Dental container; 310×190×40 mm; rot	145
136 91 0717	Kontejner dentální; 310×190×40 mm; zelený	Dental container; 310×190×40 mm; green	Dental container; 310×190×40 mm; grün	145
136 91 0718	Kontejner dentální; 310×190×40 mm; zlatý	Dental container; 310×190×40 mm; gold	Dental container; 310×190×40 mm; gold	145
136 91 0719	Kontejner dentální; 310×190×40 mm; černý	Dental container; 310×190×40 mm; black	Dental container; 310×190×40 mm; schwarz	145
136 91 0720	Kontejner dentální; 310×190×65 mm; stříbrný	Dental container; 310×190×65 mm; silver	Dental container; 310×190×65 mm; silber	145
136 91 0721	Kontejner dentální; 310×190×65 mm; modrý	Dental container; 310×190×65 mm; blue	Dental container; 310×190×65 mm; blau	145
136 91 0722	Kontejner dentální; 310×190×65 mm; červený	Dental container; 310×190×65 mm; red	Dental container; 310×190×65 mm; rot	145
136 91 0723	Kontejner dentální; 310×190×65 mm; zelený	Dental container; 310×190×65 mm; green	Dental container; 310×190×65 mm; grün	145
136 91 0724	Kontejner dentální; 310×190×65 mm; zlatý	Dental container; 310×190×65 mm; gold	Dental container; 310×190×65 mm; gold	145
136 91 0725	Kontejner dentální; 310×190×65 mm; černý	Dental container; 310×190×65 mm; black	Dental container; 310×190×65 mm; schwarz	145
136 91 0726	Kontejner dentální; 310×190×130 mm; stříbrný	Dental container; 310×190×130 mm; silver	Dental container; 310×190×130 mm; silber	145
136 91 0727	Kontejner dentální; 310×190×130 mm; modrý	Dental container; 310×190×130 mm; blue	Dental container; 310×190×130 mm; blau	145
136 91 0728	Kontejner dentální; 310×190×130 mm; červený	Dental container; 310×190×130 mm; red	Dental container; 310×190×130 mm; rot	145
136 91 0729	Kontejner dentální; 310×190×130 mm; zelený	Dental container; 310×190×130 mm; green	Dental container; 310×190×130 mm; grün	145
136 91 0730	Kontejner dentální; 310×190×130 mm; zlatý	Dental container; 310×190×130 mm; gold	Dental container; 310×190×130 mm; gold	145
136 91 0731	Kontejner dentální; 310×190×130 mm; černý	Dental container; 310×190×130 mm; black	Dental container; 310×190×130 mm; schwarz	145
136 91 1275	Buben sterilizační; 125×80 mm	Sterilization drum; 125×80 mm	Sterilisationstrommel 125×80 mm	143
136 91 1276	Buben sterilizační; 125×100 mm	Sterilization drum; 125×100 mm	Sterilisationstrommel 125×100 mm	143
136 91 1277	Buben sterilizační; 125×125 mm	Sterilization drum; 125×125 mm	Sterilisationstrommel 125×125 mm	143
136 91 1278	Buben sterilizační; 150×100 mm	Sterilization drum; 150×100 mm	Sterilisationstrommel 150×100 mm	143

číslo – number	název	item	Artikel	strana – page
136 91 1360	Buben sterilizační; 390×340 mm	Sterilization drum; 390×340 mm	Sterilisationstrommel 390×340 mm	142
136 91 1361	Buben sterilizační; 390×390 mm	Sterilization drum; 390×390 mm	Sterilisationstrommel 390×390 mm	142
136 91 1362	Buben sterilizační; 390×490 mm	Sterilization drum; 390×490 mm	Sterilisationstrommel 390×490 mm	142
136 91 1363	Buben sterilizační; 390×590 mm	Sterilization drum; 390×590 mm	Sterilisationstrommel 390×590 mm	142
136 91 1364	Buben sterilizační; 480×165 mm	Sterilization drum; 480×165 mm	Sterilisationstrommel 480×165 mm	142
136 91 1365	Buben sterilizační; 480×190 mm	Sterilization drum; 480×190 mm	Sterilisationstrommel 480×190 mm	142
136 91 1366	Buben sterilizační; 480×240 mm	Sterilization drum; 480×240 mm	Sterilisationstrommel 480×240 mm	142
136 91 1367	Buben sterilizační; 480×290 mm	Sterilization drum; 480×290 mm	Sterilisationstrommel 480×290 mm	142
136 91 1368	Buben sterilizační; 480×340 mm	Sterilization drum; 480×340 mm	Sterilisationstrommel 480×340 mm	142
136 91 1369	Buben sterilizační; 480×390 mm	Sterilization drum; 480×390 mm	Sterilisationstrommel 480×390 mm	142
139	STOMATOLOGICKÉ SOUBORY	STOMATOLOGICAL SETS	DENTAL-SÄTZE	
139 50 0120	Soubor základních stom.nástrojů malý	Set of basic stomatological instruments small	Satz der dent. Instrumenten, klein	74
139 50 0150	Držák	Holder	Instrumentenhalter für 5 Instrumente	74, 139
139 50 0160	Kazeta s držákem	Cassette with holder	Kassette für 5 Instrumente	74, 139
139 50 0170	Kazeta pro stomatologické nástroje	Cassette	Kassette 22,0×10,5×3,6 cm	139
139 50 0360	Soubor pro zubní techniky	Set for dental technicians	Set für Zahntechniker	122
139 50 0770	Soubor parodontologických nástrojů, set 1	Set of periodontal instruments, set 1	Satz der Parodontologie-Instrumenten 1	100
139 50 0780	Soubor parodontologických nástrojů, set 2	Set of periodontal instruments, set 2	Satz der Parodontologie-Instrumenten 2	100
139 50 0810	Soubor parodontologických nástrojů Mini, set 1	Set of mini periodontal instruments, set 1	Satz der mini Parodontologie-Instrumenten 1	100
147	NÁSTROJE NA ZUBNÍ KÁMEN	SCALERS	ZAHNREINIGER	
147 51 0010	Nástroj na zubní kámen; 15,5 cm	Scaler; 15,5 cm	Zahnreiniger; 15,5 cm	102
147 51 0016	Nástroj na zubní kámen; 15,5 cm	Scaler; 15,5 cm	Zahnreiniger; 15,5 cm	102
147 51 0018	Nástroj na zubní kámen; 15,5 cm TiN	Scaler TiN; 15,5 cm	Zahnreiniger TiN; 15,5 cm	102
147 51 0020	Drápek na zubní kámen; 15,5 cm	Scaler; 15,5 cm	Zahnreiniger; 15,5 cm	102
147 51 0026	Drápek na zubní kámen; 15,5 cm	Scaler; 15,5 cm	Zahnreiniger; 15,5 cm	102
147 51 0028	Drápek na zubní kámen; 15,5 cm TiN	Scaler TiN; 15,5 cm	Zahnreiniger TiN; 15,5 cm	102
147 51 0030	Srpek na zubní kámen; 0,6 mm; 15,5 cm	Scaler; 0,6 mm; 15,5 cm	Zahnreiniger; 0,6 mm; 15,5 cm	102
147 51 0036	Srpek na zubní kámen; 0,6 mm; 15,5 cm	Scaler; 0,6 mm; 15,5 cm	Zahnreiniger; 0,6 mm; 15,5 cm	102
147 51 0038	Srpek na zubní kámen; 0,6 mm; 15,5 cm TiN	Scaler TiN; 0,6 mm; 15,5 cm	Zahnreiniger TiN; 0,6 mm; 15,5 cm	102
147 51 0040	Srpek na zubní kámen; 0,9 mm; 15,5 cm	Scaler; 0,9 mm; 15,5 cm	Zahnreiniger; 0,9 mm; 15,5 cm	74, 102
147 51 0046	Srpek na zubní kámen; 0,9 mm; 15,5 cm	Scaler; 0,9 mm; 15,5 cm	Zahnreiniger; 0,9 mm; 15,5 cm	102
147 51 0048	Srpek na zubní kámen; 0,9 mm; 15,5 cm TiN	Scaler TiN; 0,9 mm; 15,5 cm	Zahnreiniger TiN; 0,9 mm; 15,5 cm	102
147 51 0060	Srpek na zubní kámen 2×lomený; 15,5 cm	Scaler double angled; 15,5 cm	Zahnreiniger; 15,5 cm	103
147 51 0066	Srpek na zubní kámen 2×lomený; 15,5 cm	Scaler double angled; 15,5 cm	Zahnreiniger; 15,5 cm	103
147 51 0068	Srpek na zubní kámen 2×lomený; 15,5 cm TiN	Scaler double angled TiN; 15,5 cm	Zahnreiniger TiN; 15,5 cm	103
147 51 0070	Škrabka na zubní kámen pravá; 2 mm; 15,5 cm	Scaler right; 2 mm; 15,5 cm	Zahnreiniger rechts; 2 mm; 15,5 cm	103
147 51 0076	Škrabka na zubní kámen pravá; 2 mm; 15,5 cm	Scaler right; 2 mm; 15,5 cm	Zahnreiniger rechts; 2 mm; 15,5 cm	104
147 51 0078	Škrabka na zubní kámen pravá; 2 mm; 15,5 cm TiN	Scaler right TiN; 2 mm; 15,5 cm	Zahnreiniger rechts TiN; 2 mm; 15,5 cm	103
147 51 0080	Škrabka na zubní kámen pravá; 3 mm; 15,5 cm	Scaler right; 3 mm; 15,5 cm	Zahnreiniger rechts; 3 mm; 15,5 cm	103
147 51 0086	Škrabka na zubní kámen pravá; 3 mm; 15,5 cm	Scaler right; 3 mm; 15,5 cm	Zahnreiniger rechts; 3 mm; 15,5 cm	104
147 51 0088	Škrabka na zubní kámen pravá; 3 mm; 15,5 cm TiN	Scaler right TiN; 3 mm; 15,5 cm	Zahnreiniger rechts TiN; 3 mm; 15,5 cm	103
147 51 0100	Škrabka na zubní kámen levá; 2 mm; 15,5 cm	Scaler left; 2 mm; 15,5 cm	Zahnreiniger links; 2 mm; 15,5 cm	103
147 51 0106	Škrabka na zubní kámen levá; 2 mm; 15,5 cm	Scaler left; 2 mm; 15,5 cm	Zahnreiniger links; 2 mm; 15,5 cm	104
147 51 0108	Škrabka na zubní kámen levá; 2 mm; 15,5 cm TiN	Scaler left TiN; 2 mm; 15,5 cm	Zahnreiniger links TiN; 2 mm; 15,5 cm	103
147 51 0110	Škrabka na zubní kámen levá; 3 mm; 15,5 cm	Scaler left; 3 mm; 15,5 cm	Zahnreiniger links; 3 mm; 15,5 cm	103
147 51 0116	Škrabka na zubní kámen levá; 3 mm; 15,5 cm	Scaler left; 3 mm; 15,5 cm	Zahnreiniger links; 3 mm; 15,5 cm	104
147 51 0118	Škrabka na zubní kámen levá; 3 mm; 15,5 cm TiN	Scaler left TiN; 3 mm; 15,5 cm	Zahnreiniger links TiN; 3 mm; 15,5 cm	103
147 51 0130	Black dlátko na sklovinu pravé; 9×2 mm; 15,5 cm	Black scaler right; 9×2 mm; 15,5 cm	Black Schmelzmesser rechts; 9×2 mm; 15,5 cm	107
147 51 0136	Black dlátko na sklovinu pravé; 9×2 mm; 15,5 cm	Black scaler right; 9×2 mm; 15,5 cm	Black Schmelzmesser rechts; 9×2 mm; 15,5 cm	107
147 51 0138	Black dlátko na sklovinu pravé; 9×2 mm; 15,5 cm TiN	Black scaler right TiN; 9×2 mm; 15,5 cm	Black Schmelzmesser rechts TiN; 9×2 mm; 15,5 cm	107
147 51 0150	Black dlátko na sklovinu levé; 9×2 mm; 15,5 cm	Black scaler left; 9×2 mm; 15,5 cm	Black Schmelzmesser links; 9×2 mm; 15,5 cm	107
147 51 0156	Black dlátko na sklovinu levé; 9×2 mm; 15,5 cm	Black scaler left; 9×2 mm; 15,5 cm	Black Schmelzmesser links; 9×2 mm; 15,5 cm	107
147 51 0158	Black dlátko na sklovinu levé; 9×2 mm; 15,5 cm TiN	Black scaler left TiN; 9×2 mm; 15,5 cm	Black Schmelzmesser links TiN; 9×2 mm; 15,5 cm	107
147 51 0170	Black dlátko na sklovinu pravé; 8×1,5 mm; 15,5 cm	Black scaler right; 8×1,5 mm; 15,5 cm	Black Schmelzmesser rechts; 8×1,5 mm; 15,5 cm	107
147 51 0176	Black dlátko na sklovinu pravé; 8×1,5 mm; 15,5 cm	Black scaler right; 8×1,5 mm; 15,5 cm	Black Schmelzmesser rechts; 8×1,5 mm; 15,5 cm	107
147 51 0178	Black dlátko na sklovinu pravé; 8×1,5 mm; 15,5 cm TiN	Black scaler right TiN; 8×1,5 mm; 15,5 cm	Black Schmelzmesser rechts TiN; 8×1,5 mm; 15,5 cm	107
147 51 0180	Black dlátko na sklovinu levé; 8×1,5 mm; 15,5 cm	Black scaler left; 8×1,5 mm; 15,5 cm	Black Schmelzmesser links; 8×1,5 mm; 15,5 cm	107
147 51 0186	Black dlátko na sklovinu levé; 8×1,5 mm; 15,5 cm	Black scaler left; 8×1,5 mm; 15,5 cm	Black Schmelzmesser links; 8×1,5 mm; 15,5 cm	107
147 51 0188	Black dlátko na sklovinu levé; 8×1,5 mm; 15,5 cm TiN	Black scaler left TiN; 8×1,5 mm; 15,5 cm	Black Schmelzmesser links TiN; 8×1,5 mm; 15,5 cm	107
147 51 0200	Nástroj na zubní kámen pravý; 1,5 mm; 15,5 cm	Cutting instrument right; 1,5 mm; 15,5 cm	Zahnreiniger rechts; 1,5 mm; 15,5 cm	105
147 51 0206	Nástroj na zubní kámen pravý; 1,5 mm; 15,5 cm	Cutting instrument right; 1,5 mm; 15,5 cm	Zahnreiniger rechts; 1,5 mm; 15,5 cm	105
147 51 0208	Nástroj na zubní kámen pravý; 1,5 mm; 15,5 cm TiN	Cutting instrument right TiN; 1,5 mm; 15,5 cm	Zahnreiniger rechts TiN; 1,5 mm; 15,5 cm	105
147 51 0210	Nástroj na zubní kámen pravý; 2,0 mm; 15,5 cm	Cutting instrument right; 2,0 mm; 15,5 cm	Zahnreiniger rechts; 2,0 mm; 15,5 cm	105
147 51 0216	Nástroj na zubní kámen pravý; 2,0 mm; 15,5 cm	Cutting instrument right; 2,0 mm; 15,5 cm	Zahnreiniger rechts; 2,0 mm; 15,5 cm	105
147 51 0218	Nástroj na zubní kámen pravý; 2,0 mm; 15,5 cm TiN	Cutting instrument right TiN; 2,0 mm; 15,5 cm	Zahnreiniger rechts TiN; 2,0 mm; 15,5 cm	105
147 51 0220	Nástroj na zubní kámen pravý; 2,5 mm; 15,5 cm	Cutting instrument right; 2,5 mm; 15,5 cm	Zahnreiniger rechts TiN; 2,0 mm; 15,5 cm	105
147 51 0226	Nástroj na zubní kámen pravý; 2,5 mm; 15,5 cm	Cutting instrument right; 2,5 mm; 15,5 cm	Zahnreiniger rechts; 2,5 mm; 15,5 cm	105
147 51 0228	Nástroj na zubní kámen pravý; 2,5 mm; 15,5 cm TiN	Cutting instrument right TiN; 2,5 mm; 15,5 cm	Zahnreiniger rechts TiN; 2,5 mm; 15,5 cm	105
147 51 0250	Nástroj na zubní kámen levý; 1,5 mm; 15,5 cm	Cutting instrument left; 1,5 mm; 15,5 cm	Zahnreiniger links; 1,5 mm; 15,5 cm	105
147 51 0256	Nástroj na zubní kámen levý; 1,5 mm; 15,5 cm	Cutting instrument left; 1,5 mm; 15,5 cm	Zahnreiniger links; 1,5 mm; 15,5 cm	105
147 51 0258	Nástroj na zubní kámen levý; 1,5 mm; 15,5 cm TiN	Cutting instrument left TiN; 1,5 mm; 15,5 cm	Zahnreiniger links TiN; 1,5 mm; 15,5 cm	105
147 51 0260	Nástroj na zubní kámen levý; 2,0 mm; 15,5 cm	Cutting instrument left; 2,0 mm; 15,5 cm	Zahnreiniger links; 2,0 mm; 15,5 cm	105
147 51 0266	Nástroj na zubní kámen levý; 2,0 mm; 15,5 cm	Cutting instrument left; 2,0 mm; 15,5 cm	Zahnreiniger links; 2,0 mm; 15,5 cm	105
147 51 0268	Nástroj na zubní kámen levý; 2,0 mm; 15,5 cm TiN	Cutting instrument left TiN; 2,0 mm; 15,5 cm	Zahnreiniger links TiN; 2,0 mm; 15,5 cm	105
147 51 0270	Nástroj na zubní kámen levý; 2,5 mm; 15,5 cm	Cutting instrument left; 2,5 mm; 15,5 cm	Zahnreiniger links; 2,5 mm; 15,5 cm	105
147 51 0276	Nástroj na zubní kámen levý; 2,5 mm; 15,5 cm	Cutting instrument left; 2,5 mm; 15,5 cm	Zahnreiniger links; 2,5 mm; 15,5 cm	105
147 51 0278	Nástroj na zubní kámen levý; 2,5 mm; 15,5 cm TiN	Cutting instrument left TiN; 2,5 mm; 15,5 cm	Zahnreiniger links TiN; 2,5 mm; 15,5 cm	105
147 51 0300	Black dlátko na sklovinu; 9×1,5 mm; 15,5 cm	Black enamel chisel; 9×1,5 mm; 15,5 cm	Black Schmelzmesser; 9×1,5 mm; 15,5 cm	106
147 51 0306	Black dlátko na sklovinu; 9×1,5 mm; 15,5 cm	Black enamel chisel; 9×1,5 mm; 15,5 cm	Black Schmelzmesser; 9×1,5 mm; 15,5 cm	106
147 51 0308	Black dlátko na sklovinu; 9×1,5 mm; 15,5 cm TiN	Black enamel chisel TiN; 9×1,5 mm; 15,5 cm	Black Schmelzmesser TiN; 9×1,5 mm; 15,5 cm	106
147 51 0310	Black dlátko na sklovinu; 9×2,0 mm; 15,5 cm	Black enamel chisel; 9×2,0 mm; 15,5 cm	Black Schmelzmesser; 9×2,0 mm; 15,5 cm	106

číslo – number	název	item	Artikel	strana – page
147 51 0316	Black dlátko na sklovinu; 9×2,0 mm; 15,5 cm	Black enamel chisel; 9×2,0 mm; 15,5 cm	Black Schmelzmesser; 9×2,0 mm; 15,5 cm	106
147 51 0318	Black dlátko na sklovinu; 9×2,0 mm; 15,5 cm TiN	Black enamel chisel TiN; 9×2,0 mm; 15,5 cm	Black Schmelzmesser TiN; 9×2,0 mm; 15,5 cm	106
147 51 0320	Black dlátko na sklovinu; 9×3,0 mm; 15,5 cm	Black enamel chisel; 9×3,0 mm; 15,5 cm	Black Schmelzmesser; 9×3,0 mm; 15,5 cm	106
147 51 0326	Black dlátko na sklovinu; 9×3,0 mm; 15,5 cm	Black enamel chisel; 9×3,0 mm; 15,5 cm	Black Schmelzmesser; 9×3,0 mm; 15,5 cm	106
147 51 0328	Black dlátko na sklovinu; 9×3,0 mm; 15,5 cm TiN	Black enamel chisel TiN; 9×3,0 mm; 15,5 cm	Black Schmelzmesser TiN; 9×3,0 mm; 15,5 cm	106
147 51 0336	Black škrabka na zubní kámen levá; 1,0 mm; 15,5 cm	Black scaler left; 1,0 mm; 15,5 cm	Black Zahnreiner links; 1,0 mm; 15,5 cm	104
147 51 0346	Black škrabka na zub. kámen pravá; 1,0 mm; 15,5 cm	Black scaler right; 1,0 mm; 15,5 cm	Black Zahnreiner rechts; 1,0 mm; 15,5 cm	104
147 51 0350	Black dlátko na sklovinu zahnuté; 8×1,5 mm; 15,5 cm	Black enamel chisel curved; 8×1,5 mm; 15,5 cm	Black Schmelzmesser gebogen; 8×1,5 mm; 15,5 cm	106
147 51 0356	Black dlátko na sklovinu zahnuté; 8×1,5 mm; 15,5 cm	Black enamel chisel curved; 8×1,5 mm; 15,5 cm	Black Schmelzmesser gebogen; 8×1,5 mm; 15,5 cm	106
147 51 0358	Black dlátko na sklovinu zahnuté; 8×1,5 mm; 15,5 cm TiN	Black enamel chisel curved TiN; 8×1,5 mm; 15,5 cm	Black Schmelzmesser gebogen TiN; 8×1,5 mm; 15,5 cm	106
147 51 0360	Black dlátko na sklovinu zahnuté; 9×2 mm; 15,5 cm	Black enamel chisel curved; 9×2 mm; 15,5 cm	Black Schmelzmesser gebogen; 9×2 mm; 15,5 cm	106
147 51 0366	Black dlátko na sklovinu zahnuté; 9×2 mm; 15,5 cm	Black enamel chisel curved; 9×2 mm; 15,5 cm	Black Schmelzmesser gebogen; 9×2 mm; 15,5 cm	106
147 51 0368	Black dlátko na sklovinu zahnuté; 9×2 mm; 15,5 cm TiN	Black enamel chisel curved TiN; 9×2 mm; 15,5 cm	Black Schmelzmesser gebogen TiN; 9×2 mm; 15,5 cm	106
147 51 0376	Black dlátko na sklovinu levé; 8×1 mm; 15,5 cm	Black enamel chisel left; 8×1 mm; 15,5 cm	Black Schmelzmesser rechts; 8×1 mm; 15,5 cm	107
147 51 0386	Black dlátko na sklovinu pravé; 8×1 mm; 15,5 cm	Black enamel chisel right; 8×1 mm; 15,5 cm	Black Schmelzmesser links; 8×1 mm; 15,5 cm	107
147 51 0806	Zešikmovač gingiválních okrajů distální; 16,6 cm	Gingival margin trimmers distal; 16,6 cm	Gingivalrandschräger Distal; 16,6 cm	104
147 51 0816	Zešikmovač gingiválních okrajů mezální; 16,6 cm	Gingival margin trimmers mesial; 16,6 cm	Gingivalrandschräger Mesial; 16,6 cm	104
148	EXKAVÁTORY	EXCAVATORS	EXKAVATOREN	
148 51 0010	Exkavátor jednostranný rovný; 2,0 mm; 15,5 cm	Excavator straight; 2,0 mm; 15,5 cm	Exkavator gerade; 2,0 mm; 15,5 cm	77
148 51 0016	Exkavátor jednostranný rovný; 2,0 mm; 15,5 cm	Excavator straight; 2,0 mm; 15,5 cm	Exkavator gerade; 2,0 mm; 15,5 cm	77
148 51 0026	Exkavátor jednostranný rovný; 2,5 mm; 15,5 cm	Excavator straight; 2,5 mm; 15,5 cm	Exkavator gerade; 2,5 mm; 15,5 cm	77
148 51 0056	Exkavátor jednostr.zahnutý pravý; 1,5 mm; 15,5 cm	Excavator curved right; 1,5 mm; 15,5 cm	Exkavator gebogen rechts; 1,5 mm; 15,5 cm	77
148 51 0076	Exkavátor jednostr.zahnutý levý; 1,5 mm; 15,5 cm	Excavator curved left; 1,5 mm; 15,5 cm	Exkavator gebogen links; 1,5 mm; 15,5 cm	77
148 51 0096	Exkavátor oboustranný; 0,8/1,0 mm; 16,8 cm	Excavator double-faced; 0,8/1,0 mm; 16,8 cm	Exkavator beiderseitig; 0,8-1,0 mm; 16,8 cm	78
148 51 0100	Exkavátor oboustranný; 1,5 mm; 17,0 cm	Excavator double-faced; 1,5 mm; 17,0 cm	Exkavator beiderseitig; 1,5 mm; 17,0 cm	78
148 51 0106	Exkavátor oboustranný; 1,5 mm; 16,8 cm	Excavator double-faced; 1,5 mm; 16,8 cm	Exkavator beiderseitig; 1,5 mm; 17,0 cm	78
148 51 0110	Exkavátor oboustranný; 2,0 mm; 17,0 cm	Excavator double-faced; 2,0 mm; 17,0 cm	Exkavator beiderseitig; 2,0 mm; 17,0 cm	74, 78
148 51 0116	Exkavátor oboustranný; 2,0 mm; 16,8 cm	Excavator double-faced; 2,0 mm; 16,8 cm	Exkavator beiderseitig; 2,0 mm; 17,0 cm	78
148 51 0120	Exkavátor oboustranný; 2,5 mm; 17,0 cm	Excavator double-faced; 2,5 mm; 17,0 cm	Exkavator beiderseitig; 2,5 mm; 17,0 cm	78
148 51 0126	Exkavátor oboustranný; 2,5 mm; 16,8 cm	Excavator double-faced; 2,5 mm; 16,8 cm	Exkavator beiderseitig; 2,5 mm; 17,0 cm	78
148 51 0136	Exkavátor oboustranný; 1,0 mm; 16,8 cm	Excavator double-faced; 1,0 mm; 16,8 cm	Exkavator beiderseitig; 1,0 mm; 16,8 cm	78
151	NÁSTROJE PRO VYPLNĚ	FILLING INSTRUMENTS	FÜLLUNGSINSTRUMENTE	
151 51 0010	Nosič amalgamu lopatkový; 3,0 mm; 15,5 cm	Plastic filling instrument – carrier; 3,0 mm; 15,5 cm	Füllungsinstrument; 3,0 mm; 15,5 cm	79
151 51 0016	Nosič amalgamu lopatkový; 3,0 mm; 15,5 cm	Plastic filling instrument – carrier; 3,0 mm; 15,5 cm	Füllungsinstrument; 3,0 mm; 15,5 cm	79
151 51 0056	Nosič amalgamu lžičkový; 1,2-3 mm; 16,7 cm	Plastic filling instrument – carrier; 1,2-3 mm; 16,7 cm	Füllungsinstrument; 1,2-3 mm; 17,6 cm	79
151 51 0060	Nosič amalgamu s kříž. řezem; 1,2-3 mm; 17,0 cm	Plastic filling instrument – carrier; 1,2-3 mm; 17,0 cm	Füllungsinstrument; 1,2-3 mm; 17,0 cm	79
151 51 0066	Nosič amalgamu s kříž. řezem; 1,2-3 mm; 16,7 cm	Plastic filling instrument – carrier; 1,2-3 mm; 16,7 cm	Füllungsinstrument; 1,2-3 mm; 17,0 cm	79
151 51 0080	Cpátko amalgamu oboustranné; 2-3 mm; 17,0 cm	Plastic filling instrument – plugger; 2-3 mm; 17,0 cm	Füllungsinstrument beiderseitig; 2-3 mm; 17,0 cm	80
151 51 0086	Cpátko amalgamu oboustranné; 2-3 mm; 16,5 cm	Plastic filling instrument – plugger; 2-3 mm; 16,5 cm	Füllungsinstrument beiderseitig; 2-3 mm; 17,0 cm	80
151 51 0096	Cpátko amalgamu oboustranné; 2-3 mm; 16,5 cm	Plastic filling instrument – plugger; 2-3 mm; 16,5 cm	Füllungsinstrument beiderseitig; 2-3 mm; 17,0 cm	80
151 51 0097	Cpátko kompoz.mater.oboustr.; 2-3 mm; 17,0 cm TiN	Plastic filling instrument – plugger TiN; 2-3 mm; 17,0 cm	Füllungsinstrument beiderseitig TiN; 2-3 mm; 17,0 cm	80
151 51 0126	Hladítko se cpátkem fig. 1; 16,6 cm	Plastic filling instrument – spatula-plugger fig. 1; 16,6 cm	Füllungsinstrument; 17,0 cm	84
151 51 0127	Hladítko se cpátkem fig. 1; 16,6 cm TiN	Plastic filling instrument – spatula-plugger fig. 1 TiN; 16,6 cm	Füllungsinstrument TiN; 17,0 cm	84
151 51 0130	Hladítko se cpátkem fig. 1; 17,0 cm	Plastic filling instrument – spatula-plugger fig. 1; 17,0 cm	Füllungsinstrument; 17,0 cm	84
151 51 0136	Hladítko se cpátkem fig. 1; 16,6 cm	Plastic filling instrument – spatula-plugger fig. 1; 16,6 cm	Füllungsinstrument; 17,0 cm	84
151 51 0140	Hladítko se cpátkem fig. 2; 17,0 cm	Plastic filling instrument – spatula-plugger fig. 2; 17,0 cm	Füllungsinstrument; 17,0 cm	84
151 51 0146	Hladítko se cpátkem fig. 2; 16,6 cm	Plastic filling instrument – spatula-plugger fig. 2; 16,6 cm	Füllungsinstrument; 17,0 cm	84
151 51 0160	Cpátko jednostr.kořenové lomené; 0,8 mm; 16,0 cm	Plastic filling instrument – plugger; 0,8 mm; 16,0 cm	Füllungsinstrument; 0,8 mm 17,0 cm	82
151 51 0166	Cpátko jednostr.kořenové lomené; 0,8 mm; 15,8 cm	Plastic filling instrument – plugger; 0,8 mm; 15,8 cm	Füllungsinstrument; 0,8 mm 17,0 cm	82
151 51 0170	Cpátko jednostr.kořenové lomené; 1,2 mm; 16,0 cm	Plastic filling instrument – plugger; 1,2 mm; 16,0 cm	Füllungsinstrument; 1,6 mm 17,0 cm	82
151 51 0176	Cpátko jednostr.kořenové lomené; 1,2 mm; 15,8 cm	Plastic filling instrument – plugger; 1,2 mm; 15,8 cm	Füllungsinstrument; 1,6 mm 17,0 cm	82
151 51 0177	Cpátko jednostr.kořenové lomené; 1,2 mm; 17,0 cm TiN	Plastic filling instrument – plugger TiN; 1,2 mm; 17,0 cm	Füllungsinstrument; 1,6 mm 17,0 cm TiN	82
151 51 0186	Cpátko oboustranné; 0,6/0,8 mm; 16,7 cm	Plastic filling instrument – plugger; 0,6/0,8 mm; 16,7 cm	Füllungsinstrument beiderseitig; 0,6-0,8 mm; 17,0 cm	82
151 51 0187	Cpátko oboustranné; 0,6/0,8 mm; 17,0 cm TiN	Plastic filling instrument – plugger TiN; 0,6/0,8 mm; 17,0 cm	Füllungsinstrument beiderseitig TiN; 0,6-0,8 mm; 17,0 cm	82
151 51 0190	Cpátko oboustranné; 1,2/1,6 mm; 17,0 cm	Plastic filling instrument – plugger; 1,2/1,6 mm; 17,0 cm	Füllungsinstrument beiderseitig; 1,2-1,6 mm; 17,0 cm	82
151 51 0196	Cpátko oboustranné; 1,2/1,6 mm; 16,8 cm	Plastic filling instrument – plugger; 1,2/1,6 mm; 16,8 cm	Füllungsinstrument beiderseitig; 1,2-1,6 mm; 17,0 cm	82
151 51 0197	Cpátko oboustranné; 1,2/1,6 mm; 17,0 cm TiN	Plastic filling instrument – plugger TiN; 1,2/1,6 mm; 17,0 cm	Füllungsinstrument beiderseitig TiN; 1,2-1,6 mm; 17,0 cm	82
151 51 0200	Cpátko oboustranné; 2,0/2,5 mm; 17,0 cm	Plastic filling instrument – plugger; 2,0/2,5 mm; 17,0 cm	Füllungsinstrument beiderseitig; 2,0-2,5 mm; 17,0 cm	82
151 51 0206	Cpátko oboustranné; 2,0/2,5 mm; 16,8 cm	Plastic filling instrument – plugger; 2,0/2,5 mm; 16,8 cm	Füllungsinstrument beiderseitig; 2,0-2,5 mm; 17,0 cm	82
151 51 0207	Cpátko oboustranné; 2,0/2,5 mm; 17,0 cm TiN	Plastic filling instrument – plugger TiN; 2,0/2,5 mm; 17,0 cm	Füllungsinstrument beiderseitig TiN; 2,0-2,5 mm; 17,0 cm	82
151 51 0246	Hladítko se cpátkem fig. 2; 16,6 cm	Plastic filling instrument – spatula-plugger fig. 2; 16,6 cm	Füllungsinstrument; 17,0 cm	84
151 51 0247	Hladítko se cpátkem fig. 2; 16,6 cm TiN	Plastic filling instrument – spatula-plugger TiN; 16,6 cm	Füllungsinstrument TiN; 17,0 cm	84
151 51 0280	Cpátko oboustranné; 1,0/1,8 mm; 17,0 cm	Plastic filling instrument – plugger; 1,0/1,8 mm; 17,0 cm	Füllungsinstrument beiderseitig; 1,0-1,8 mm; 17,0 cm	80
151 51 0286	Cpátko oboustranné; 1,0/1,8 mm; 16,6 cm	Plastic filling instrument – plugger; 1,0/1,8 mm; 16,6 cm	Füllungsinstrument beiderseitig; 1,0-1,8 mm; 17,0 cm	80
151 51 0287	Cpátko oboustranné; 1,0/1,8 mm; 17,0 cm TiN	Plastic filling instrument – plugger TiN; 1,0/1,8 mm; 17,0 cm	Füllungsinstrument beiderseitig TiN; 1,0-1,8 mm; 17,0 cm	80
151 51 0290	Cpátko oboustranné; 1,4/2,0 mm; 17,0 cm	Plastic filling instrument – plugger; 1,4/2,0 mm; 17,0 cm	Füllungsinstrument beiderseitig; 1,4-2,0 mm; 17,0 cm	80
151 51 0296	Cpátko oboustranné; 1,4/2,0 mm; 16,6 cm	Plastic filling instrument – plugger; 1,4/2,0 mm; 16,6 cm	Füllungsinstrument beiderseitig; 1,4-2,0 mm; 17,0 cm	80
151 51 0297	Cpátko oboustranné; 1,4/2,0 mm; 17,0 cm TiN	Plastic filling instrument – plugger TiN; 1,4/2,0 mm; 17,0 cm	Füllungsinstrument beiderseitig TiN; 1,4-2,0 mm; 17,0 cm	80
151 51 0306	Cpátko oboustranné; 0,6/0,8 mm; 16,6 cm	Plastic filling instrument – plugger; 0,6/0,8 mm; 16,6 cm	Füllungsinstrument beiderseitig; 0,6-0,8 mm; 16,6 cm	80
151 51 0310	Cpátko kopýtkové oboustranné; 17,0 cm	Plastic filling instrument – plugger; 17,0 cm	Füllungsinstrument beiderseitig; 17,0 cm	81
151 51 0316	Cpátko kopýtkové oboustranné; 16,6 cm	Plastic filling instrument – plugger; 16,6 cm	Füllungsinstrument beiderseitig; 17,0 cm	81
151 51 0317	Cpátko kopýtkové oboustranné; 17,0 cm TiN	Plastic filling instrument – plugger TiN; 17,0 cm	Füllungsinstrument beiderseitig TiN; 17,0 cm	81
151 51 0320	Cpátko oboustranné; 17,0 cm	Plastic filling instrument – plugger; 17,0 cm	Füllungsinstrument beiderseitig; 17,0 cm	81
151 51 0326	Cpátko oboustranné; 16,6 cm	Plastic filling instrument – plugger; 16,6 cm	Füllungsinstrument beiderseitig; 17,0 cm	81
151 51 0340	Hladítko se cpátkem fig. 3; 17,0 cm	Plastic filling instrument – spatula-plugger fig. 3; 17,0 cm	Füllungsinstrument; 17,0 cm	84
151 51 0346	Hladítko se cpátkem fig. 3; 16,6 cm	Plastic filling instrument – spatula-plugger fig. 3; 16,6 cm	Füllungsinstrument; 17,0 cm	84
151 51 0347	Hladítko se cpátkem fig. 3; 16,6 cm TiN	Plastic filling instrument – spatula-plugger fig. 3 TiN; 16,6 cm	Füllungsinstrument TiN; 17,0 cm	84
151 51 0356	Hladítko se cpátkem fig. 3; 1,0/1,5 mm; 16,4 cm	Plastic filling instrument – spatula-plugger; 1,0/1,5 mm; 16,4 cm	Füllungsinstrument; 1,0-1,5 mm 16,4 cm	84
151 51 0416	Nosič amalgamu; 1,4/2,0 mm; 16,6 cm	Plastic filling instrument – carrier; 1,4/2,0 mm; 16,6 cm	Füllungsinstrument; 1,4-2,0 mm 16,6 cm	79
151 51 0426	Nosič amalgamu; 2,5/3,0 mm 17,0 cm	Plastic filling instrument – carrier; 2,5/3,0 mm; 17,0 cm	Füllungsinstrument; 17,0 cm	79
151 51 0466	Cpátko vlákna do sulku; 2 mm 16,6 cm	Fibre filling instrument; 2 mm; 16,6 cm	Füllungsinstrument; 17,0 cm	83

číslo – number	název	item	Artikel	strana – page
151 51 0506	Čpátko vlákna do sulku; 15,4 cm	Fibre filling instrument; 15,4 cm	Füllungsinstrument; 16,6 cm	83
151 51 0516	Zavaděč retrakčních vláken; 16,8 cm	Retentive fibre instrument; 16,8 cm	Führungsinstrument für Retraktionsfaser	83
151 51 0526	Zavaděč retrakčních vláken; 16,8 cm	Retentive fibre instrument; 16,8 cm	Führungsinstrument für Retraktionsfaser	83
151 51 0570	Hladítko pružné; 2,5 mm; 15,5 cm	Plastic filling instrument; 2,5 mm; 15,5 cm	Füllungsinstrument; 15,5 cm	85
151 51 0576	Hladítko pružné; 2,5 mm; 15,3 cm	Plastic filling instrument; 2,5 mm; 15,3 cm	Füllungsinstrument; 15,5 cm	85
151 51 0577	Hladítko pružné; 2,5 mm; 15,5 cm TiN	Plastic filling instrument TiN; 2,5 mm; 15,5 cm	Füllungsinstrument TiN; 15,5 cm	85
151 51 0590	Nástroj na plast.výplně kapkovitý fig. 1; 15,5 cm	Plastic filling instrument fig. 1; 15,5 cm	Füllungsinstrument; 15,5 cm	88
151 51 0596	Nástroj na plast.výplně kapkovitý fig. 1; 15,3 cm	Plastic filling instrument fig. 1; 15,3 cm	Füllungsinstrument; 15,5 cm	88
151 51 0597	Nástroj na plast.výplně kapk. fig. 1; 15,5 cm TiN	Plastic filling instrument fig. 1 TiN; 15,5 cm	Füllungsinstrument TiN; 15,5 cm	88
151 51 0600	Nástroj na plast.výplně kapkovitý fig. 2; 15,5 cm	Plastic filling instrument – spatula fig. 2; 15,5 cm	Füllungsinstrument; 15,5 cm	88
151 51 0606	Nástroj na plast.výplně kapkovitý fig. 2; 15,3 cm	Plastic filling instrument – spatula fig. 2; 15,3 cm	Füllungsinstrument; 15,5 cm	88
151 51 0607	Nástroj na plast.výplně kapk. fig. 2; 15,5 cm TiN	Plastic filling instrument – spatula fig. 2 TiN; 15,5 cm	Füllungsinstrument TiN; 15,5 cm	88
151 51 0616	Nástroj na plast. výplně; 16,6 cm	Instrument for malleable fillings; 16,6 cm	Füllungsinstrument; 16,6 cm	88
151 51 0620	Hladítko oboustranné fig. 1; 17,0 cm	Plastic filling instrument – spatula fig. 1; 17,0 cm	Füllungsinstrument beiderseitig; 17,0 cm	86
151 51 0626	Hladítko oboustranné fig. 1; 16,6 cm	Plastic filling instrument – spatula fig. 1; 16,6 cm	Füllungsinstrument beiderseitig; 17,0 cm	86
151 51 0627	Hladítko oboustranné fig. 1; 16,6 cm TiN	Plastic filling instrument – spatula fig. 1 TiN; 16,6 cm	Füllungsinstrument beiderseitig TiN; 17,0 cm	86
151 51 0630	Hladítko oboustranné fig. 2; 17,0 cm	Plastic filling instrument – spatula fig. 2; 17,0 cm	Füllungsinstrument beiderseitig; 17,0 cm	86
151 51 0636	Hladítko oboustranné fig. 2; 16,6 cm	Plastic filling instrument – spatula fig. 2; 16,6 cm	Füllungsinstrument beiderseitig; 17,0 cm	86
151 51 0637	Hladítko oboustranné fig. 2; 16,6 cm TiN	Plastic filling instrument – spatula fig. 2 TiN; 16,6 cm	Füllungsinstrument beiderseitig TiN; 17,0 cm	86
151 51 0650	Hladítko oboustranné 3×lomené; 17,0 cm	Plastic filling instrument – spatula; 17,0 cm	Füllungsinstrument; 17,0 cm	85
151 51 0656	Hladítko oboustranné 3×lomené; 16,6 cm	Plastic filling instrument – spatula; 16,6 cm	Füllungsinstrument; 17,0 cm	85
151 51 0657	Hladítko oboustranné 3×lomené; 17,0 cm TiN	Plastic filling instrument – spatula TiN; 17,0 cm	Füllungsinstrument TiN; 17,0 cm	85
151 51 0696	Hladítko oboustranné; 1,5 mm; 17 cm	Spatula – filling instrument; 1,5 mm; 17 cm	Füllungsinstrument; 1,5 mm; 17 cm	86
151 51 0706	Heidemann hladítko oboustranné fig. 1; 16,6 cm	Heidemann spatula fig. 1; 16,6 cm	Heidemann Füllungsinstrument; 16,6 cm	86
151 51 0716	Heidemann hladítko oboustranné fig. 2; 16,9 cm	Heidemann spatula fig. 2; 16,9 cm	Heidemann Füllungsinstrument; 16,9 cm	86
151 51 0726	Heidemann hladítko oboustranné fig. 2; 17,3 cm	Heidemann spatula fig. 2; 17,3 cm	Heidemann Füllungsinstrument; 17,3 cm	86
151 51 0760	Pistole na amalgam s kovovým pístem	Amalgam gun – metal piston	Amalgampistole	90
151 51 0806	Nástroj na modelování výplně; 1,6 mm; 16,4 cm	Modelling instrument; 1,6 mm; 16,4 cm	Modellierinstrument; 1,6 mm; 17,0 cm	87
151 51 0836	Nástroj na modelování výplně; 2,5 mm; 16,4 cm	Modelling instrument; 2,5 mm; 16,4 cm	Modellierinstrument; 2,5 mm; 17,0 cm	87
151 51 0846	Nástroj na modelování výplně; 2,5 mm; 16,4 cm	Modelling instrument; 2,5 mm; 16,4 cm	Modellierinstrument; 2,5 mm; 17,0 cm	87
151 51 0856	Sapin nástroj na modelování výplně; 1,6 mm; 16,0 cm	Sapin modelling instrument; 1,6 mm; 16,0 cm	Sapin Modellierinstrument; 1,6 mm; 17,0 cm	87
151 51 0866	Frahm nástroj na modelování výplně; 5,0 mm; 16,6 cm	Frahm modelling instrument; 5,0 mm; 16,6 cm	Frahm Modellierinstrument; 5,0 mm; 17,0 cm	87
151 51 0876	Nástroj na modelování výplně; 1,4 mm; 16,6 cm	Modelling instrument; 1,4 mm; 16,6 cm	Modellierinstrument; 1,4 mm; 17,0 cm	87
151 51 0886	Nástroj na modelování výplně; 1,6/2,5 mm; 16,4 cm	Modelling instrument; 1,6/2,5 mm; 16,4 cm	Modellierinstrument; 1,6-2,5 mm; 17,0 cm	87
151 51 0887	Nástroj na modelování výplně; 1,6/2,5 mm; 17,0 cm TiN	Modelling instrument TiN; 1,6/2,5 mm; 17,0 cm	Modellierinstrument TiN; 1,6-2,5 mm; 17,0 cm	87
151 51 0930	Discoid-Cleoid nástroj na výplně; 2,0/2,2 mm; 16,8 cm	Discoid-Cleoid filling instrument; 2,0/2,2 mm; 16,8 cm	Discoid-Cleoid Füllungsinstrument; 2,2 mm	88
151 51 0936	Discoid-Cleoid nástroj na výplně; 2,0/2,2 mm; 16,8 cm	Discoid-Cleoid filling instrument; 2,0/2,2 mm; 16,8 cm	Discoid-Cleoid Füllungsinstrument; 2,2 mm	88
151 51 0970	Svorka na separační pásky 40° zahnutá; 3,3 cm	Strip clamp; 3,3 cm	Matrizenspanner gebogen; 40°; 3,3 cm	89
151 51 0980	Svorka na separační pásky 90° zahnutá; 2,5 cm	Strip clamp; 2,5 cm	Matrizenspanner gebogen; 90°; 2,5 cm	89
151 51 1010	Pásek separační hladký; 120×6 mm	Separative strip smooth; 120×6 mm	Abtrennungsband glatt; 6 mm	89
151 51 1020	Pásek separační hladký; 120×8 mm	Separative strip smooth; 120×8 mm	Abtrennungsband glatt; 9 mm; Pkc=100	89
151 51 1496	Wiland nástroj na výplně oboustranný; 16,6 cm	Wiland amalgam carver double-faced; 16,6 cm	Wiland Schnitzinstrumente; 16,6 cm	87
151 51 2020	Pásek separační diamant. 120×3 mm; D35	Separative strip diamond; D35	Abtrennungsband dia D35; 3×120	89
151 51 2021	Pásek separační diamant. 120×3 mm; D64	Separative strip diamond; D64	Abtrennungsband dia D64; 3×120	89
151 51 2022	Pásek separační diamant. 120×3 mm; D107	Separative strip diamond; D107	Abtrennungsband dia D107; 3×120	89
151 51 2030	Pásek separační diamant. 120×4 mm; D35	Separative strip diamond; D35	Abtrennungsband dia D35; 4×120	89
151 51 2031	Pásek separační diamant. 120×4 mm; D64	Separative strip diamond; D64	Abtrennungsband dia D64; 4×120	89
151 51 2032	Pásek separační diamant. 120×4 mm; D107	Separative strip diamond; D107	Abtrennungsband dia D107; 4×120	89
151 51 2040	Pásek separační diamant. 120×6 mm; D35	Separative strip diamond; D35	Abtrennungsband dia D35; 6×120	89
151 51 2041	Pásek separační diamant. 120×6 mm; D64	Separative strip diamond; D64	Abtrennungsband dia D64; 6×120	89
151 51 2042	Pásek separační diamant. 120×6 mm; D107	Separative strip diamond; D107	Abtrennungsband dia D107; 6×120	89
151 51 2050	Pásek separační diamant. 120×8 mm; D35	Separative strip diamond; D35	Abtrennungsband dia D35; 8×120	89
151 51 2051	Pásek separační diamant. 120×8 mm; D64	Separative strip diamond; D64	Abtrennungsband dia D64; 8×120	89
151 51 2052	Pásek separační diamant. 120×8 mm; D107	Separative strip diamond; D107	Abtrennungsband dia D107; 8×120	89
151 51 3006	Čpátko oboustran.kombinované; 0,8/1,0 mm; 16,6 cm	Plastic filling instrument – plugger; 0,8/1,0 mm; 16,6 cm	Füllungsinstrument beiderseitig; 0,8-1,0 mm; 16,6 cm	81
151 51 3016	Čpátko oboustran.kombinované; 1,2/1,4 mm; 16,6 cm	Plastic filling instrument – plugger; 1,2/1,4 mm; 16,6 cm	Füllungsinstrument beiderseitig; 1,2-1,4 mm; 16,6 cm	81
151 51 3026	Čpátko oboustran.kombinované; 1,6/2,0 mm; 16,6 cm	Plastic filling instrument – plugger; 1,6/2,0 mm; 16,6 cm	Füllungsinstrument beiderseitig; 1,6-2,0 mm; 16,6 cm	81
151 51 3210	Nástroj pro výplně; 1,4 mm; 16,6 cm	Filling instrument; 1,4 mm; 16,6 cm	Füllungsinstrument; 1,4 mm; 17,0 cm	87
151 51 3220	Nástroj pro výplně; 2,0 mm; 16,6 cm	Filling instrument; 2,0 mm; 16,6 cm	Füllungsinstrument; 2,0 mm; 17,0 cm	87
151 51 3570	Hladítko pružné jemné; 15,5 cm	Plastic filling instrument – spatula flexible; 15,5 cm	Füllungsinstrument; 15,5 cm	85
151 51 3576	Hladítko pružné jemné; 15,3 cm	Plastic filling instrument – spatula flexible; 15,3 cm	Füllungsinstrument; 15,5 cm	85
151 51 3577	Hladítko pružné jemné; 15,5 cm TiN	Plastic filling instrument TiN – spatula flexible; 15,5 cm	Füllungsinstrument TiN; 15,5 cm	85
151 51 3620	Hladítko oboustranné jemné fig. 1; 17,0 cm	Plastic filling instrument – spatula fig. 1; 17,0 cm	Füllungsinstrument beiderseitig; 15,5 cm	86
151 51 3626	Hladítko oboustranné jemné fig. 1; 16,6 cm	Plastic filling instrument – spatula fig. 1; 16,6 cm	Füllungsinstrument beiderseitig; 15,5 cm	86
151 51 3627	Hladítko oboustranné jemné fig. 1; 16,6 cm TiN	Plastic filling instrument TiN – spatula fig. 1; 16,6 cm	Füllungsinstrument beiderseitig TiN; 15,5 cm	86
151 51 3630	Hladítko oboustranné jemné fig. 2; 17,0 cm	Plastic filling instrument – spatula fig. 2; 17,0 cm	Füllungsinstrument beiderseitig; 17,3 cm	86
151 51 3636	Hladítko oboustranné jemné fig. 2; 16,6 cm	Plastic filling instrument – spatula fig. 2; 16,6 cm	Füllungsinstrument beiderseitig; 17,3 cm	86
151 51 3637	Hladítko oboustranné jemné fig. 2; 16,6 cm TiN	Plastic filling instrument TiN – spatula fig. 2; 16,6 cm	Füllungsinstrument beiderseitig TiN; 17,3 cm	86
151 51 3650	Hladítko oboustranné jemné 3×lomené; 17,0 cm	Plastic filling instrument – spatula; 17,0 cm	Füllungsinstrument beiderseitig; 15,5 cm	85
151 51 3656	Hladítko oboustranné jemné 3×lomené; 16,6 cm	Plastic filling instrument – spatula; 16,6 cm	Füllungsinstrument beiderseitig; 15,5 cm	85
151 51 3657	Hladítko oboustranné jemné 3×lomené; 16,6 cm TiN	Plastic filling instrument TiN – spatula; 16,6 cm	Füllungsinstrument beiderseitig TiN; 15,5 cm	85
151 56 0056	Nosič amalgamu lžičkový; 1,2/3 mm; 16,7 cm	Carrier hollow handle; 1,2/3 mm; 16,7 cm	Füllungsinstrument Hohlgriff; 1,2-3 mm; 17,0 cm	79
151 56 0066	Nosič amalgamu s kříž. Řezem; 1,2/3 mm; 16,7 cm	Carrier hollow handle; 1,2/3 mm; 16,7 cm	Füllungsinstrument Hohlgriff; 1,2-3 mm; 17,0 cm	79
151 56 0086	Čpátko amalgamu oboustranné; 2/3 mm; 16,5 cm	Filling instrument – angled hollow handle; 2/3 mm; 16,5 cm	Füllungsinstrument beiderseitig Hohlgriff; 2-3 mm; 17,0 cm	80
151 56 0096	Čpátko amalgamu oboustranné; 2/3 mm; 16,5 cm	Filling instrument – angled hollow handle; 2/3 mm; 16,5 cm	Füllungsinstrument beiderseitig Hohlgriff; 2-3 mm; 17,0 cm	80
151 56 0097	Čpátko komp.mat.oboustr.; 2-3 mm; 16,6 cm TiN	Filling instrument – angled hollow handle TiN; 2/3 mm; 16,6 cm	Füllungsinstrument beiderseitig TiN Hohlgriff; 2-3 mm; 17,0 cm	80
151 56 0126	Hladítko se čpátkem fig. 1; 16,6 cm	Spatula – filling instrument hollow handle; 16,6 cm	Füllungsinstrument Hohlgriff; 17,0 cm	84
151 56 0127	Hladítko se čpátkem fig. 1; 16,6 cm TiN	Spatula – filling instrument – hollow handle TiN; 16,6 cm	Füllungsinstrument TiN Hohlgriff; 17,0 cm	84
151 56 0136	Hladítko se čpátkem fig. 1; 16,6 cm	Spatula – filling instrument hollow handle; 16,6 cm	Füllungsinstrument Hohlgriff; 17,0 cm	84
151 56 0146	Hladítko se čpátkem fig. 2; 17,0 cm	Spatula – filling instrument hollow handle; 17,0 cm	Füllungsinstrument Hohlgriff; 17,0 cm	84
151 56 0186	Čpátko oboustranné; 0,6/0,8 mm; 16,7 cm	Filling instrument – angled hollow handle; 0,6/0,8 mm; 16,7 cm	Füllungsinstrument beiderseitig Hohlgriff; 0,6-08 mm; 17,0 cm	82

číslo – number	název	item	Artikel	strana – page
151 56 0187	Cpátko oboustranné; 0,6/0,8 mm; 16,7 cm TiN	Filling instrument – angled hollow handle TiN; 0,6/0,8 mm; 16,7 cm	Füllungsinstrument beiderseitig TiN Hohlgriff; 0,6-0,8 mm; 17,0 cm	82
151 56 0196	Cpátko oboustranné; 1,2/1,6 mm; 16,8 cm	Filling instrument – angled hollow handle; 1,2/1,6 mm; 16,8 cm	Füllungsinstrument beiderseitig Hohlgriff; 1,2-1,6 mm; 17,0 cm	82
151 56 0197	Cpátko oboustranné; 1,2/1,6 mm; 16,8 cm TiN	Filling instrument – angled hollow handle TiN; 1,2/1,6 mm; 16,8 cm	Füllungsinstrument beiderseitig TiN Hohlgriff; 1,2-1,6 mm; 17,0 cm	82
151 56 0206	Cpátko oboustranné; 2,0/2,5 mm; 16,8 cm	Filling instrument – angled hollow handle; 2,0/2,5 mm; 16,8 cm	Füllungsinstrument beiderseitig Hohlgriff; 2,0-2,5 mm; 17,0 cm	82
151 56 0207	Cpátko oboustranné; 2,0/2,5 mm; 16,8 cm TiN	Filling instrument – angled hollow handle TiN; 2,0/2,5 mm; 16,8 cm	Füllungsinstrument beiderseitig TiN Hohlgriff; 2,0-2,5 mm; 17,0 cm	82
151 56 0246	Hladítko se cpátkem fig. 2; 16,6 cm	Spatula – filling instrument hollow handle; 16,6 cm	Füllungsinstrument Hohlgriff; 17,0 cm	84
151 56 0247	Hladítko se cpátkem fig. 2; 16,6 cm TiN	Spatula – filling instrument hollow handle TiN; 16,6 cm	Füllungsinstrument TiN Hohlgriff; 17,0 cm	84
151 56 0286	Cpátko oboustranné; 1,0/1,8 mm; 16,6 cm	Filling instrument – angled hollow handle; 1,0/1,8 mm; 16,6 cm	Füllungsinstrument beiderseitig Hohlgriff; 1,0-1,8 mm; 17,0 cm	80
151 56 0287	Cpátko oboustranné; 1,0/1,8 mm; 16,6 cm TiN	Filling instrument – angled hollow handle TiN; 1,0/1,8 mm; 16,6 cm	Füllungsinstrument beiderseitig TiN Hohlgriff; 1,0-1,8 mm; 17,0 cm	80
151 56 0296	Cpátko oboustranné; 1,4/2,0 mm; 16,6 cm	Filling instrument – angled hollow handle; 1,4/2,0 mm; 16,6 cm	Füllungsinstrument beiderseitig Hohlgriff; 1,4-2,0 mm; 17,0 cm	80
151 56 0297	Cpátko oboustranné; 1,4/2,0 mm; 16,6 cm TiN	Filling instrument – angled hollow handle TiN; 1,4/2,0 mm; 16,6 cm	Füllungsinstrument beiderseitig TiN Hohlgriff; 1,4-2,0 mm; 17,0 cm	80
151 56 0306	Cpátko oboustranné; 0,6/0,8 mm; 16,6 cm	Filling instrument – angled hollow handle; 0,6/0,8 mm; 16,6 cm	Füllungsinstrument beiderseitig Hohlgriff; 0,6-0,8 mm; 16,6 cm	80
151 56 0316	Cpátko kopýtkové oboustranné; 16,6 cm	Filling instrument – angled hollow handle; 16,6 cm	Füllungsinstrument beiderseitig Hohlgriff; 17,0 cm	81
151 56 0317	Cpátko kopýtkové oboustranné; 16,6 cm TiN	Filling instrument – angled hollow handle TiN; 16,6 cm	Füllungsinstrument beiderseitig TiN Hohlgriff; 17,0 cm	81
151 56 0326	Cpátko oboustranné; 16,6 cm	Filling instrument – angled hollow handle; 16,6 cm	Füllungsinstrument beiderseitig Hohlgriff; 17,0 cm	81
151 56 0346	Hladítko se cpátkem fig. 3; 16,6 cm	Spatula – filling instrument hollow handle; 16,6 cm	Füllungsinstrument Hohlgriff; 17,0 cm	84
151 56 0347	Hladítko se cpátkem fig. 3; 16,6 cm TiN	Spatula – filling instrument hollow handle TiN; 16,6 cm	Füllungsinstrument TiN Hohlgriff; 17,0 cm	84
151 56 0356	Hladítko se cpátkem; 1,0/1,5 mm; 16,4 cm	Spatula – filling instrument hollow handle; 1,0/1,5 mm; 16,4 cm	Füllungsinstrument Hohlgriff; 1,0-5,0 mm; 16,4 cm	84
151 56 0416	Nosič amalgamu; 1,4/2,0 mm; 16,6 cm	Carrier hollow handle; 1,4/2,0 mm; 16,6 cm	Füllungsinstrument Hohlgriff; 1,4-2,0 mm; 16,6 cm	79
151 56 0426	Nosič amalgamu; 2,5/3,0 mm; 16,6 cm	Carrier hollow handle; 2,5/3,0 mm; 16,6 cm	Füllungsinstrument Hohlgriff; 17,0 cm	79
151 56 0466	Cpátko vlákna do sluku; 2 mm; 16,6 cm	Fibre filling instrument hollow handle; 2 mm; 16,6 cm	Füllungsinstrument Hohlgriff; 17,0 cm	83
151 56 0516	Zavaděč retrakčních vláken (přední zuby); 2,5 mm; 16,8 cm	Retentive fibre instrument; 16,8 cm	Führungsinstrument für Retraktionsfaser Hohlgriff	83
151 56 0526	Zavaděč retrakčních vláken (zadní zuby); 2,5 mm; 16,8 cm	Retentive fibre instrument; 16,8 cm	Führungsinstrument für Retraktionsfaser Hohlgriff	83
151 56 0616	Nástroj na plast. výplně; 16,6 cm	Instrument for malleable fillings; 16,6 cm	Füllungsinstrument Hohlgriff; 15,5 cm	88
151 56 0626	Hladítko oboustranné fig. 1; 16,6 cm	Spatula hollow handle; 16,6 cm	Füllungsinstrument beiderseitig Hohlgriff; 17,0 cm	86
151 56 0627	Hladítko oboustranné fig. 1; 16,6 cm TiN	Spatula hollow handle tin; 16,6 cm TiN	Füllungsinstrument beiderseitig TiN Hohlgriff; 17,0 cm	86
151 56 0636	Hladítko oboustranné fig. 2; 16,6 cm	Spatula hollow handle; 16,6 cm	Füllungsinstrument beiderseitig Hohlgriff; 17,0 cm	86
151 56 0637	Hladítko oboustranné fig. 2; 116,6 cm TiN	Spatula hollow handle tin; 116,6 cm TiN	Füllungsinstrument beiderseitig TiN Hohlgriff; 17,0 cm	86
151 56 0656	Hladítko oboustranné 3× lomené; 16,6 cm	Spatula 3× angled hollow handle; 16,6 cm	Füllungsinstrument Hohlgriff; 17,0 cm	85
151 56 0657	Hladítko oboustranné 3× lomené; 16,6 cm TiN	Spatula 3× angled hollow handle tin; 16,6 cm TiN	Füllungsinstrument TiN Hohlgriff; 17,0 cm	85
151 56 0696	Hladítko oboustranné; 1,5 mm; 16,6 cm	Spatula – filling instrument hollow handle; 1,5 mm; 16,6 cm	Füllungsinstrument beiderseitig Hohlgriff; 17,0 cm	86
151 56 0706	Heidenmann hladítko oboustranné fig. 1; 16,6 cm	Heidenmann spatula hollow handle; 16,6 cm	Heidemann Füllungsinstrument beiderseitig Hohlgriff Fig.1; 16,6 cm	86
151 56 0716	Heidenmann hladítko oboustranné fig. 2; 16,9 cm	Heidenmann spatula hollow handle; 16,9 cm	Heidemann Füllungsinstrument beiderseitig Hohlgriff Fig.2; 16,9 cm	86
151 56 0726	Heidenmann hladítko oboustranné fig. 2; 17,3 cm	Heidenmann spatula hollow handle; 17,3 cm	Heidemann Füllungsinstrument beiderseitig Hohlgriff Fig.3; 17,3 cm	86
151 56 0806	Nástroj na modelování výplně; 1,6 mm; 16,4 cm	Filling instrument hollow handle; 1,6 mm; 16,4 cm	Modellierinstrument Hohlgriff; 1,6 mm; 17,0 cm	87
151 56 0836	Nástroj na modelování výplně; 2,5 mm; 16,4 cm	Filling instrument hollow handle; 2,5 mm; 16,4 cm	Modellierinstrument Hohlgriff; 2,5 mm; 17,0 cm	87
151 56 0846	Nástroj na modelování výplně; 2,5 mm; 16,4 cm	Filling instrument hollow handle; 2,5 mm; 16,4 cm	Modellierinstrument Hohlgriff; 2,5 mm; 17,0 cm	87
151 56 0856	Sapin nástroj na modelování výplně; 1,6 mm; 16,0 cm	Filling instrument hollow handle; 1,6 mm; 16,0 cm	Sapin Modellierinstrument Hohlgriff; 1,6 mm; 17,0 cm	87
151 56 0866	Frahm nástroj na modelování výplně; 5,0 mm; 16,6 cm	Filling instrument hollow handle; 5,0 mm; 16,6 cm	Frahm Modellierinstrument Hohlgriff; 5,0 mm; 17,0 cm	87
151 56 0876	Nástroj na modelování výplně; 1,4 mm; 16,6 cm	Filling instrument hollow handle; 1,4 mm; 16,6 cm	Modellierinstrument Hohlgriff; 1,4 mm; 17,0 cm	87
151 56 0886	Nástroj na modelování výplně; 1,6/2,5 mm; 16,4 cm	Filling instrument hollow handle; 1,6/2,5 mm; 16,4 cm	Modellierinstrument Hohlgriff; 1,6-2,5 mm; 17,0 cm	87
151 56 0887	Nástroj na modelování výplně; 1,6/2,5 mm; 16,4 cm TiN	Filling instrument hollow handle TiN; 1,6/2,5 mm; 16,4 cm	Modellierinstrument TiN Hohlgriff; 1,6-2,5 mm; 17,0 cm	87
151 56 0936	Discoid-Cleoid nástroj na výplně; 2,0/2,2 mm; 16,8 cm	Filling instrument hollow handle TiN; 2,0/2,2 mm; 16,8 cm	Discoid-Cleoid Füllungsinstrument Hohlgriff; 22 mm	88
151 56 1496	Wiland nástroj na výplně oboustranný; 16,6 cm	Wiland amalgam carver double-faced; 16,6 cm	Wiland Schnitzinstrumente; 16,6 cm	87
151 56 3006	Cpátko oboustran.kombinované; 0,8/1,0 mm; 16,6 cm	Filling instrument – angled hollow handle; 0,8/1,0 mm; 16,6 cm	Füllungsinstrument beiderseitig Hohlgriff; 0,8-1,0 mm; 16,6 cm	81
151 56 3016	Cpátko oboustran.kombinované; 1,2/1,4 mm; 16,6 cm	Filling instrument – angled hollow handle; 1,2/1,4 mm; 16,6 cm	Füllungsinstrument beiderseitig Hohlgriff; 1,2-1,4 mm; 16,6 cm	81
151 56 3026	Cpátko oboustran.kombinované; 1,6/2,0 mm; 16,6 cm	Filling instrument – angled hollow handle; 1,6/2,0 mm; 16,6 cm	Füllungsinstrument beiderseitig Hohlgriff; 1,6-2,0 mm; 16,6 cm	81
151 56 3626	Hladítko oboustranné jemné fig. 1; 16,6 cm	Spatula hollow handle; 16,6 cm	Füllungsinstrument beiderseitig Hohlgriff Fig.1; 15,5 cm	86
151 56 3627	Hladítko oboustranné jemné fig. 1; 16,6 cm TiN	Spatula hollow handle TiN; 16,6 cm TiN	Füllungsinstrument beiderseitig TiN Hohlgriff; 15,5 cm	86
151 56 3636	Hladítko oboustranné jemné fig. 2; 16,6 cm	Spatula hollow handle; 16,6 cm	Füllungsinstrument beiderseitig Hohlgriff Fig.2; 17,3 cm	86
151 56 3637	Hladítko oboustranné jemné fig. 2; 16,6 cm TiN	Spatula hollow handle TiN; 16,6 cm TiN	Füllungsinstrument beiderseitig TiN Hohlgriff; 17,3 cm	86
151 56 3656	Hladítko oboustranné jemné 3× lomené; 16,6 cm	Spatula 3× angled hollow handle; 16,6 cm	Füllungsinstrument beiderseitig Hohlgriff; 15,5 cm	85
151 56 3657	Hladítko oboustranné jemné 3× lomené; 16,6 cm TiN	Spatula 3× angled hollow handle TiN; 16,6 cm TiN	Füllungsinstrument beiderseitig TiN Hohlgriff; 15,5 cm	85
152	ORTODONCIE, ZUBNÍ NÁHRADY	ORTHODONTIC, TOOTH REPLACEMENT	ORTHODONTIE, ZAHNERSÄTZE	
152 52 0810	Ortodontický šroub, oboustranný, fig. 1; 1,1 cm	Expanding screw, double faced fig. 1; 1,1 cm	KFO Schraube, fig. 1	111
152 52 0820	Ortodontický šroub, oboustranný, fig. 2; 1,3 cm	Expanding screw, double faced fig. 2; 1,3 cm	KFO Schraube, fig. 2	111
152 52 0950	Ortodontický šroub jednostranný, fig. 1; 1,3 cm	Expanding screw, one faced fig. 1; 1,3 cm	KFO Schraube, fig. 1	111
152 52 0960	Ortodontický šroub jednostranný, fig. 2; 1,5 cm	Expanding screw, one faced fig. 2; 1,5 cm	KFO Schraube, fig. 2	111
152 52 0970	Ortodontický šroub jednostranný, fig. 3; 1,7 cm	Expanding screw, one faced fig. 3; 1,7 cm	KFO Schraube, fig. 3	111
152 52 0980	Ortodontický šroub jednostranný, fig. 4; 1,7 cm	Expanding screw, one faced fig. 4; 1,7 cm	KFO Schraube, fig. 4	111
152 52 0990	Ortodontický šroub jednostranný, fig. 5; 1,3 cm	Expanding screw, one faced fig. 5; 1,3 cm	KFO Schraube, fig. 5	111
152 52 1000	Ortodontický šroub jednostranný, fig. 6; 1,7 cm	Expanding screw, one faced fig. 6; 1,7 cm	KFO Schraube, fig. 6	111
152 52 1020	Kloub k ortodontickému šroubu vějířový	Expanding screw for fan expansion	Gelenke zu KFO Schraube	112
152 52 1040	Ortošroub k vějířové expanzi; 7 mm	Expanding screw for fan expansion	KFO Schraube zu fächerförmiger Expansion	112
152 52 1050	Ortošroub bodový rovně zakončený; expanze 5 mm	Expanding screw – point; expansion 5 mm	KFO Schraube, Expansion 5 mm	112
152 52 1060	Ortošroub bodový kulově zakončený; expanze 5 mm	Expanding screw – point; expansion 5 mm	KFO Schraube, Expansion 5 mm	112
152 52 1900	Zesilovací mřížka zlacená; 60×54×12 mm	Mesh strengthener; 60×54×12 mm	Gitter vergoldet; 60×54×12 mm	130
152 52 1910	Zesilovací mřížka nerezová; 60×54×12 mm	Mesh strengthener; 60×54×12 mm	Gitter rostfrei; 60×54×12 mm	130
154	OTISKOVACÍ LŽÍČE	IMPRESSION TRAYS	ABDRUCKLÖFFEL	
154 52 0110	Lžiče otiskovací; BOX1	Impression tray; BOX1	Abdrucklöffel; BOX1	131, 134
154 52 0120	Lžiče otiskovací; BOX2	Impression tray; BOX2	Abdrucklöffel; BOX2	131, 134
154 52 0130	Lžiče otiskovací; BOX3	Impression tray; BOX3	Abdrucklöffel; BOX3	131, 134
154 52 0140	Lžiče otiskovací; BOX4	Impression tray; BOX4	Abdrucklöffel; BOX4	131, 134
154 52 0260	Lžiče otiskovací; FX1	Impression tray; FX1	Abdrucklöffel; FX1	131, 134
154 52 0270	Lžiče otiskovací; FX2	Impression tray; FX1	Abdrucklöffel; FX1	131, 134
154 52 0280	Lžiče otiskovací; FX3	Impression tray; FX1	Abdrucklöffel; FX1	131, 134
154 52 0360	Lžiče otiskovací; DHX1	Impression tray; DHX1	Abdrucklöffel; DHX1	132, 134
154 52 0370	Lžiče otiskovací; DHX2	Impression tray; DHX2	Abdrucklöffel; DHX2	132, 134
154 52 0380	Lžiče otiskovací; DHX3	Impression tray; DHX3	Abdrucklöffel; DHX3	132, 134
154 52 0460	Lžiče otiskovací; DDX1	Impression tray; DDX1	Abdrucklöffel; DDX1	132, 134
154 52 0470	Lžiče otiskovací; DDX2	Impression tray; DDX2	Abdrucklöffel; DDX2	132, 134

číslo – number	název	item	Artikel	strana – page
154 52 0480	Lžice otiskovací; DDX3	Impression tray; DDX3	Abdrucklöffel; DDX3	132, 134
154 52 0550	Lžice otiskovací; PPX	Impression tray; PPX	Abdrucklöffel; PPX	132, 134
154 52 0560	Lžice otiskovací; PLX	Impression tray; PLX	Abdrucklöffel; PLX	132, 134
154 52 0600	Lžice otiskovací korunková	Crown impression tray	Kronenabdrucklöffel	132
154 52 0610	Lžice otiskovací; FOX1	Impression tray; FOX1	Abdrucklöffel; FOX1	133
154 52 0620	Lžice otiskovací; FOX2	Impression tray; FOX2	Abdrucklöffel; FOX2	133
154 52 0630	Lžice otiskovací; FOX3	Impression tray; FOX3	Abdrucklöffel; FOX3	133
154 52 0640	Lžice otiskovací; FOX4	Impression tray; FOX4	Abdrucklöffel; FOX4	133
154 52 0660	Lžice otiskovací; UUX1	Impression tray; UUX1	Abdrucklöffel; UUX1	133
154 52 0670	Lžice otiskovací; UUX2	Impression tray; UUX2	Abdrucklöffel; UUX2	133
154 52 0680	Lžice otiskovací; UUX3	Impression tray; UUX3	Abdrucklöffel; UUX3	133
154 52 0690	Lžice otiskovací; UUX4	Impression tray; UUX4	Abdrucklöffel; UUX4	133
154 52 0790	Lžice otiskovací; BOXC3	Impression tray; BOXC3	Abdrucklöffel; BOXC3	133
154 52 0820	Lžice otiskovací; FXC2	Impression tray; FXC2	Abdrucklöffel; FXC2	133
154 52 0830	Lžice otiskovací; FXC3	Impression tray; FXC3	Abdrucklöffel; FXC3	133
154 52 1550	Soubor otiskovacích lžic perforovaných; 9 ks	Set of impression perforated trays; 9 pcs	Abdrucklöffelset 9 Stk. gelochte ausführung	134
154 52 1650	Soubor otiskovacích lžic dětských perforovaných; 6 ks	Set of impression perforated trays for children	Kinderabdrucklöffelset 6 Stk. gelochte ausführung	134
154 52 9010	Lžice otiskovací-nerez; H1	Impression tray-stainless steel; H1	Abdrucklöffel-rostfrei; H1	131
154 52 9011	Lžice otiskovací-nerez; H2	Impression tray-stainless steel; H2	Abdrucklöffel-rostfrei; H2	131
154 52 9012	Lžice otiskovací-nerez; H3	Impression tray-stainless steel; H3	Abdrucklöffel-rostfrei; H3	131
154 52 9013	Lžice otiskovací-nerez; H4	Impression tray-stainless steel; H4	Abdrucklöffel-rostfrei; H4	131
154 52 9014	Lžice otiskovací-nerez; D1	Impression tray-stainless steel; D1	Abdrucklöffel-rostfrei; D1	131
154 52 9015	Lžice otiskovací-nerez; D2	Impression tray-stainless steel; D2	Abdrucklöffel-rostfrei; D2	131
154 52 9016	Lžice otiskovací-nerez; D3	Impression tray-stainless steel; D3	Abdrucklöffel-rostfrei; D3	131
154 52 9017	Lžice otiskovací-nerez; D4	Impression tray-stainless steel; D4	Abdrucklöffel-rostfrei; D4	131
154 52 9018	Lžice otiskovací-nerez; HX1	Impression tray-stainless steel; HX1	Abdrucklöffel-rostfrei; HX1	131
154 52 9019	Lžice otiskovací-nerez; HX2	Impression tray-stainless steel; HX2	Abdrucklöffel-rostfrei; HX2	131
154 52 9020	Lžice otiskovací-nerez; HX3	Impression tray-stainless steel; HX3	Abdrucklöffel-rostfrei; HX3	131
154 52 9021	Lžice otiskovací-nerez; HX4	Impression tray-stainless steel; HX4	Abdrucklöffel-rostfrei; HX4	131
154 52 9022	Lžice otiskovací-nerez; DX1	Impression tray-stainless steel; DX1	Abdrucklöffel-rostfrei; DX1	131
154 52 9023	Lžice otiskovací-nerez; DX2	Impression tray-stainless steel; DX2	Abdrucklöffel-rostfrei; DX2	131
154 52 9024	Lžice otiskovací-nerez; DX3	Impression tray-stainless steel; DX3	Abdrucklöffel-rostfrei; DX3	131
154 52 9025	Lžice otiskovací-nerez; DX4	Impression tray-stainless steel; DX4	Abdrucklöffel-rostfrei; DX4	131
155	NÁSTROJE MODELOVACÍ	MODELLING INSTRUMENTS	MODELLIERINSTRUMENTE	
155 52 0180	Le Cron nástroj modelovací; 17,5 cm	Le Cron modelling instrument; 17,5 cm	Le Cron Modellierinstrument; 17,5 cm	122, 123
155 52 0212	Nůž modelovací; 13,0 cm	Modelling knife; 13,0 cm	Wachsmesser; 13,0 cm	122, 123
155 52 0222	Nůž modelovací; 17,4 cm	Modelling knife; 17,4 cm	Wachsmesser; 17,4 cm	122, 123
155 52 1402	Nástroj modelovací fig. 1; 16,2 cm	Modelling instrument fig. 1; 16,2 cm	Modellierinstrument Fig.1; 16,2 cm	124, 125
155 52 1412	Nástroj modelovací fig. 2; 16,4 cm	Modelling instrument fig. 2; 16,4 cm	Modellierinstrument Fig.2; 16,4 cm	124, 125
155 52 1422	Nástroj modelovací fig. 3; 16,7 cm	Modelling instrument fig. 3; 16,7 cm	Modellierinstrument Fig.3; 16,7 cm	124, 125
155 52 1432	Nástroj modelovací fig. 4; 16,5 cm	Modelling instrument fig. 4; 16,5 cm	Modellierinstrument Fig.4; 16,5 cm	124, 125
155 52 1442	Nástroj modelovací fig. 5; 16,2 cm	Modelling instrument fig. 5; 16,2 cm	Modellierinstrument Fig.5; 16,2 cm	124, 125
155 52 1452	Nástroj modelovací fig. 6; 16,8 cm	Modelling instrument fig. 6; 16,8 cm	Modellierinstrument Fig.6; 16,8 cm	124, 125
155 52 1462	Nástroj modelovací fig. 7; 15,6 cm	Modelling instrument fig. 7; 15,6 cm	Modellierinstrument Fig.7; 15,6 cm	124, 125
155 52 1472	Nástroj modelovací fig. 8; 15,9 cm	Modelling instrument fig. 8; 15,9 cm	Modellierinstrument Fig.8; 15,9 cm	124, 125
155 52 1482	Nástroj modelovací fig. 9; 15,9 cm	Modelling instrument fig. 9; 15,9 cm	Modellierinstrument Fig.9; 15,9 cm	124, 125
155 52 9000	Sada modelovacích nástrojů	Set of modelling instruments	Modellierinstrumenten-satz	125
156	MATRICE	MATRIX BANDS	MATRIZENBÄNDER	
156 52 0010	Ivory matrice na tvarování výplní malá; 2,5 cm	Ivory matrix band small; 2,5 cm	Ivory Matrizenbänder klein	92
156 52 0020	Ivory matrice na tvarování výplní střední; 3,6 cm	Ivory matrix band medium; 3,6 cm	Ivory Matrizenbänder mittler	92
156 52 0030	Ivory matrice na tvarování výplní velká; 3,5 cm	Ivory matrix band large; 3,5 cm	Ivory Matrizenbänder groß	92
156 52 0050	Ivory napínač matric; 7,0 cm	Ivory matrix retainer; 7,0 cm	Ivory Matrizenspanner; 7,0 cm	92
156 52 0070	Ivory separátor; 6,7 cm	Ivory separator; 6,7 cm	Ivory Separator; 6,7 cm	92
156 52 0300	Napínač matric; 6,4 cm	Universal retainer; 6,4 cm	Matrizenspanner; 6,4 cm	93
156 91 0001	Matrice pásková; 5 mm; 1 m	Matrix band; 5 mm; 1 m	Matrizenband; 5 mm; 1 m	93
156 91 0002	Matrice pásková; 6 mm; 1 m	Matrix band; 6 mm; 1 m	Matrizenband; 6 mm; 1 m	93
156 91 0003	Matrice pásková; 7 mm; 1 m	Matrix band; 7 mm; 1 m	Matrizenband; 7 mm; 1 m	93
157	KYVETY, TRĚMENY, LISY	FLASKS, CLAPS, PRESSES	KÜVETTEN, BÜGEL, PRESSEN	
157 52 0011	Kyveta korunková	Crown flask	Kronenküvette	128
157 52 0021	Kyveta čtyřdílná nerezová	Four-piece flask stainless	Vierteilgküvette rostfrei	128
157 52 0030	Trmen pro jednu kyvetu; 17,0 cm	Clap for one flask; 17,0 cm	Bügel für 1 Küvette; 15,0 cm	127
157 52 0031	Kyveta čtyřdílná mosazná	Four-piece flask brass	Messingvierteilgküvette	128
157 52 0040	Trmen pro dvě kyvety; 22,5 cm	Clap for two flasks; 22,5 cm	Bügel für 2 Küvetten; 22,5 cm	127
157 52 0050	Trmen pro tři kyvety; 28,0 cm	Clap for three flasks; 28,0 cm	Bügel für 3 Küvetten; 28,0 cm	127
157 52 0210	Opěrka kyvety korunkové	Support of crown flask	Kronenküvettenstütze	128
158	POMŮCKY PRO LITÍ	CASTING DEVICES	GIESSINSTRUMENTE	
158 52 0010	Kroužek kovový licí; 22×30 mm	Casting ring; 22×30 mm	Gießring; 22×30 mm	130
158 52 0020	Kroužek kovový licí; 28×40 mm	Casting ring; 28×40 mm	Gießring; 28×40 mm	130
158 52 0030	Kroužek kovový licí; 40×45 mm	Casting ring; 40×45 mm	Gießring; 40×45 mm	130
158 52 0040	Kroužek kovový licí; 40×48 mm	Casting ring; 40×48 mm	Gießring; 40×48 mm	130
158 52 0050	Kroužek kovový licí; 50×55 mm	Casting ring; 50×55 mm	Gießring; 50×55 mm	130
158 52 0060	Kroužek kovový licí; 60×55 mm	Casting ring; 60×55 mm	Gießring; 60×55 mm	130
158 52 0070	Kroužek kovový licí; 70×55 mm	Casting ring; 70×55 mm	Gießring; 70×55 mm	130
158 52 0080	Kroužek kovový licí; 80×55 mm	Casting ring; 80×55 mm	Gießring; 80×55 mm	130
158 52 0090	Kroužek kovový licí; 25×35 mm	Casting ring; 25×35 mm	Gießring; 25×35 mm	130
158 91 0001	Podložka pod licí kroužky; 9,0 cm	Washer for casting rings; 9,0 cm	Muffelringformer; 9,0 cm	129
158 99 0022	Kroužek kovový licí; 38×55 mm	Casting ring; 38×55 mm	Gießring; 38×55 mm	129
158 99 0023	Kroužek kovový licí; 48×55 mm	Casting ring; 48×55 mm	Gießring; 48×55 mm	129
158 99 0024	Kroužek kovový licí; 65×55 mm	Casting ring; 65×55 mm	Gießring; 65×55 mm	129
158 99 0025	Kroužek kovový licí; 30×55 mm	Casting ring; 30×55 mm	Gießring; 30×55 mm	129
158 99 0026	Kroužek kovový licí; 80×55 mm	Casting ring; 80×55 mm	Gießring; 80×55 mm	129

číslo – number	název	item	Artikel	strana – page
159	POMOCNÉ VYBAVENÍ	AUXILIARY DEVICES	HILFSINSTRUMENTE	
159 53 0050	Nádobka na vatu s pružinou	Cotton wool box with spring	Wattebehälter	137
159 53 0060	Nádobka na vatové odpadky	Cotton wool container	Wattemüllbehälter	137
159 53 0100	Držátko ubrousku řetízkové, UH svorky; 47,0 cm	Napkin holder with metal chain; 47,0 cm	Servittenthalter mit Kette	137
159 53 0110	Držátko ubrousku UH, kovové svorky; 48,0 cm	Napkin holder with metal chain	Servittenthalter mit Kette	137
159 53 0120	Držátko ubrousku řetízkové, kovové svorky 23,0 cm	Napkin holder with metal chain	Servittenthalter mit Kette	137
285 499 54 7000	Plomba pro sterilizační kontejnery	Seal for sterilizing containers	Sicherheitsverschluss Plastik	147
943 61 0005	Klíček ortodontický	Orthodontic spanner	Schlüssel für KFO Schrauben	112

A

Adson pinzeta anatomická 66

B

Babcock svorka chirurgická 47
Backhaus svorka na prádlo 48
Backhaus-Clip svorka na prádlo 48
Barry páka extrakční 21
Bein páka extrakční 21, 22
Black dlátka na sklovinu 106, 107
Black škrabka na zubní kámen 104
Blumenthal kleště štípací na kosti 16
Boynton jehelec oční 50
Brünnings lopatka na jazyk 72
Buben sterilizační 142, 143
Buchwald lopatka na jazyk 72

C

Castroviejo jehelec 53
Castroviejo jehelec mikro 53
Castroviejo nůžky na duhovku 61
Castroviejo nůžky oční 61
Cleveland kleště štípací na kosti 16
Collin kleště na jazyk 19
Cpátka amalgamu 80
Cpátka kombinované 81
Cpátka kompozitních materiálů 80
Cpátka kopytkové 81
Cpátka kořenové 82
Cpátka oboustranné 80, 81, 82
Cpátka vlákna do sulku 83
Crile jehelec 50, 52
Cushing háček 32

Č

Čepelka skalpelová 44

D

Desmarres háček 32
Dieffenbach skalpel oční 42
Discoid-Cleoid nástroj na výplně 88
Dlaha dentální prefabrikovaná 55
Dláto ploché 28
Dláto poloklínové 29
Dláto žlábkové 28, 29
Drápek na zubní kámen 102
Držák 74, 139
Držátko skalpelových čepelek 43, 125
Držátko ubrousku 137
Držátko zubního zrcátka 73, 74

E

Exkavátor 77
Exkavátor oboustranný 74, 78
Explorer 97

F

Filtr 147
Flohr páka extrakční 22
Frahm nástroj na modelování výplně 87
Freer páčidlo na nosní přepážku 20
Freer páčidlo nosní 20
Friedman kleště štípací na kosti 16
Furkační kyreta 101

G

Gillies pinzeta chirurgická 66
Goldman-Fox nůžky na dáseň 57
Gomel nůžky mikro 62
Gracey kyreta 98, 100
Graefe pinzeta fixační 67
Graefe pinzeta oční 67

H

Háček na rány 31
Háček oční 33
Háček pro plastiku 33
Hák intraorální 36
Hák resekcí 35
Halsted-Mosquito svorka na cévy 46
Hartmann svorka 46
Heidemann hladítka 86
Heister rozvěrač úst 37
Heywood-Smith kleště tamponové 19
Hladítka 85, 86
Hladítka pružná 85
Hladítka se cpátkem 84

I

Ivory matrice na tvarování výplně 92
Ivory napínač matric 92
Ivory separátor 92

J

Jacobson jehelec mikro 53
Jansen kleště štípací 17
Jehelec hloubkový 50, 51
Jehelec s vnitřním uzávěrem 50
Jennings rozvěrač úst 38
Jeweler pinzeta 66
Joseph háček na rány 31
Joseph pilník 27

K

Kazeta pro stomatologické nástroje 139
Kazeta s držákem 74, 139
Kelly svorka na cévy 47
Kladívko chirurgické kovové 30
Kladívko laboratorní ocelové 126
Kleště extrakční 11–15
Kleště k odstranění kořenových nástrojů 15
Kleště laboratorní 114, 122
Kleště laboratorní čočkové 114
Kleště laboratorní kuželové 114
Kleště laboratorní oblé 114
Kleště laboratorní ohýbací 115, 116
Kleště laboratorní ploché 114, 115
Kleště laboratorní utahovací 116
Kleště na kelímky 113
Kleště štípací 18
Kleště štípací na drát 113
Klíček ortodontický 112
Kloub k ortodontickému šroubu 112
Kontejner ½ 144
Kontejner dentální 145
Kontejner mini 146
Koš síťový 144–146
Krabíčka na katetry 140
Krabíčka na umělý chrup 142

Krabička s bočními prohlubněmi	142
Krabička s poklopem	140
Krabička s příhradkami	140
Krabička s rovným víkem	140
Krabička s vypouklým víčkem	140
Krabička sterilizační	139
Kroužek kovový lící	130
Kyveta čtyřdílná	128
Kyveta korunková	128

L

Langenbeck hák na rány	33
Langenbeck chránič prstu	37
Langenbeck páčidlo	20
Langenbeck škrabka	26
Le Cron nástroj modelovací	122, 123
Lecluse páka extrakční	25
List k pilce stomatologické	120
Lister nůžky na obvazy	56
Liston kleště štípací	18
Löbker kleště na jazyk	19
Lopatka na cement	91, 121
Lopatka na míchání otiskovacích hmot	91, 121
Lopatka na sádro	121
Lorna svorka na prádlo	49
Luer kleště štípací na kosti	16–17
Luniatschek zavaděč drenů	54
Lžice otiskovací	131–134
Lžice otiskovací korunková	132
Lžička exkochleační bajonetová	41
Lžička laboratorní	121
Lžička oboustranná	39
Lžička ostrá	40

M

Mathieu jehelec	50, 52
Matrice pásková	93
Micro-Mosquito svorka na cévy	46
Middeldorpf hák na rány	34
Mini Gracey kyreta	99, 100
Mini-Friedman kleště štípací na kosti	16
Mini-Langenbeck háček	32
Mosquito-Halsted svorka na cévy	45, 122, 125

N

Nabers furkační sonda	97
Nádobka kovová	139
Nádobka medicinská kovová	139
Nádobka na vatové odpady	137
Nádobka na vatu s pružinou	137
Nádobka oválná – emitní miska	139
Napínač matric	93
Nástroj modelovací	124, 125
Nástroj na modelování výplně	87
Nástroj na plastické výplně	88
Nástroj na snímání korunek	94
Nástroj na zubní kámen	102, 105
Nástroj pro výplně	87
Nosič amalgamu	79
Noyes nůžky na duhovku	61
Nůž modelovací	122, 123
Nůž na dáseň	41
Nůž na gingivektomii	41
Nůž na sádro s otvíračem	121, 122
Nůžky	60
Nůžky chirurgické	58
Nůžky lomené	60
Nůžky mikro	62
Nůžky na dáseň	57
Nůžky na korunky	120
Nůžky na měkké obvazy	56

O

Obtahovací kamínek na ostření kyret	101
Oehler pinzeta chirurgická	66
Olsen-Hegar jehelec/nůžky	51
Opěrka kyvety korunkové	128
Ortodontický šroub	111
Ortošroub bodový	112
Ortošroub k vějířové expanzi	112

P

Páčidlo na nosní přepážku	20
Páka extrakční	23, 25
Pásek separační diamantovaný	89
Pásek separační hladký	89
Pátradlo zubní	71, 74
Peers svorka na prádlo	49
Pilník	27
Pilník diamantovaný	108
Pinzeta anatomická	64, 125
Pinzeta laboratorní	68, 119
Pinzeta na kořenové čípky	63
Pinzeta zkřížená	68, 119
Pinzeta zkřížená se šroubovákem	68, 119
Pinzeta zubní	63, 74, 122
Pistole na amalgam	90
Plomba pro sterilizační kontejnery	147
Podložka pod lící kroužky	129
Podložka silikonová	148
Přecechtěl škrabka nosní	26

Q

Quinby nůžky na dáseň	57
-----------------------	----

R

Rám napínací	144, 145, 146
Rám upínací pilky stomatologické	120
Reynolds nůžky preparační	59
Roeder svorka na prádlo	49
Rochester-Pean svorka na cévy	47
Roser-König rozvěrač úst	37
Rouška textilní zelená	148
Ryder jehelec tvrdokov	51

S

Sada modelovacích nástrojů	125
Sanvenero nůžky preparační	59
Sapin nástroj na modelování výplně	87
Scaler oboustranný	100, 101
Semken pinzeta anatomická	66
Schlemmer páka extrakční	23
Síto oddělovací	144
Sonda parodontologická	97
Soubor otiskovacích lžic	134
Soubor parodontologických nástrojů	100
Soubor pro zubní techniky	122
Soubor základních stomatologických nástrojů	74
Srpek na zubní kámen	74, 102, 103
Standard nůžky chirurgické	58, 59
Standard pinzeta anatomická	65
Standard pinzeta chirurgická	65
Stellbrink kleště štípací na kosti	16
Svorka na separační pásy	89

Š

Škrabka na operaci slzného vaku	26
Škrabka na zubní kámen	103, 104
Špinar páka extrakční	24
Štítek identifikační	147

T

Tácek	141
Tácek dentální	141
Testovací tyčinka PMMA	101
Tohoku-Japan svorka na prádlo	49
Toulec na pinzety	138
Třmen pro kyvety	127

U

Utahovací klíček	43
------------------	----

V

Vana neperforovaná	144–146
Vana perforovaná	144–146
Víko neperforované	144–146
Víko ochranné	144
Víko perforované	144–146
Vložka síťová	146

W

Wamkey nástroj na snímání korunek	94
West dláto žlábkové	28
White páka extrakční	24, 25
Whitehead rozvěrač úst	38
Wiland nástroj na výplně	87
Williger páčidlo	20
Williger škrabka	26

Z

Zámek bezpečnostní plastový	147
Zavaděč retrakčních vláken	83
Zesilovací mřížka	130
Zešikmovač gingiválních okrajů	104
Zrcátko zubní	73, 74

A

Adson forceps	66
Amalgam gun – metal piston	90

B

Babcock tissue seizing forceps	47
Backhaus towel forceps	48
Backhaus-Clip towel forceps	48
Barry root elevator	25
Bein root elevator	21, 22
Black enamel chisel	106, 107
Black scaler	104, 107
Blade	44
Blade of stomatological saw	120
Blumenthal bone ronguers	16
Bone curette	41
Bone curette double-faced	39
Bone rongeurs	18
Bottom non perforated	144–146
Bottom perforated	144–146
Bowl	139
Box	140, 142
Box for denture	142
Boynton eye needle holder	50
Brünnings tongue spatula	72

C

Carrier	79
Cassette	139
Cassette with holder	74, 139
Casting ring	129, 130
Castroviejo eye scissors	61
Castroviejo iris scissors	61
Castroviejo micro-needle holder	53
Castroviejo needle holder	53
Cement spatula	91, 121
Chisel flat	28
Chisel grooved	29
Chisel half-wedged	29
Clap for flasks	127
Cleveland bone ronguers	16
Cloth green	148
Collin tongue holding forceps	19
Container ½	144
Cotton wool box	137
Cotton wool container	137
Crile needle holder	50, 52
Cross-action forceps	68, 119
Cross-action forceps with screwdriver	68, 119
Crown flask	128
Crown impression tray	132
Crown remover	94
Crown scissors	120
Crucible forceps	113
Cushing delicate hook	32
Cutting instrument	105

D

Delicate hook	31
Dental container	145
Dental forceps angled	63
Dental forceps curved	63, 74, 122
Dental mirror	73
Dental probe	71, 74

Dental tray	141
Desmarres delicate hook	32
Diamond file	108
Diamond file needle	108
Dieffenbach knife	42
Discoid-Cleoid filling instrument	88
Dissection micro scissors	62
Divider	144
Drape retainer dental	144–146
Dressing forceps	65

E

Excavator curved	77
Excavator double-faced	74, 78
Excavator straight	77
Expanding screw	111
Expanding screw – point	112
Expanding screw for fan expansion	112
Explorer	97
Extraction forceps	11–15
Eye hook	33

F

Fibre filling instrument	83
Filling instrument	80–82, 87, 88
Filter	147
Flohr root elevator	22
Forceps for extraction of root instruments	15
Four-piece flask	128
Frahm modelling instrument	87
Frame of stomatological saw	120
Freer nasal elevator	20
Freer septum elevator	20
Friedman bone ronguers	16
Furcation curette	101

G

Gillies tissue forceps	66
Gingival margin trimmers	104
Gingivectomy knife	41
Goldman-Fox scissors	57
Gomel dissection micro scissors	62
Gouge grooved	28
Gracey curette	98, 100
Graefe eye forceps	67
Graefe fixation forceps	67
Gum knife mutual	41
Gum scissors	57

H

Halsted-Mosquito artery forceps	46
Hartmann forceps	46
Heidemann spatula	86
Heister mouth retractor	37
Heywood-Smith sponge holding forceps	19
Holder	74, 139

I

Identification label	147
Impression tray	131–134
Instrument for malleable fillings	88
Intraolar hook	36
Ivory matrix band	92
Ivory matrix retainer	92
Ivory separator	92

J			
Jacobson micro-needle holder TUC	53		
Jansen mastoid forceps	17		
Jennings mouth retractor	38		
Jeweler forceps	66		
Joseph delicate hook	31		
Joseph rasp	27		
K			
Kelly artery forceps	47		
L			
Laboratory bending forceps	116		
Laboratory forceps	68, 114, 119, 122		
Laboratory forceps with conical jaws	114		
Laboratory forceps with flat jaws	114, 115		
Laboratory forceps with groove jaws	115		
Laboratory forceps with lens jaws	114		
Laboratory forceps with rounded jaws	114		
Laboratory mallet	126		
Laboratory spoon	121		
Laboratory tighten forceps	116		
Lachrymal sac raspatory	26		
Langenbeck elevator	20		
Langenbeck finger protector	37		
Langenbeck raspatory	26		
Langenbeck retractor	33		
Le Cron modelling instrument	122, 123		
Lecluse root elevator	25		
Lid non perforated	144–146		
Lid perforated	144–146		
Lister bandage scissors	56		
Liston bone rongeurs	18		
Löbker tongue holding forceps	19		
Lorna towel forceps	49		
Luer bone rongeurs	16–17		
Luniatschek drain introducer	54		
M			
Mathieu needle holder	50, 52		
Matrix band	93		
Mesh strengthener	130		
Micro-Mosquito artery forceps	46		
Middeldorpf retractor	34		
Mini Gracey curette	99, 100		
Mini-Friedman bone rongeurs	16		
Mini-Langenbeck delicate hook	32		
Mirror handle	73, 74		
Mixing spatula	91, 121		
Modelling instrument	87, 124, 125		
Modelling knife	122, 123		
Mosquito-Halsted artery forceps	45, 122, 125		
Mouth mirror	73, 74		
N			
Nabers furcation sonde	97		
Napkin holder	137		
Needle holder	50, 51		
Noyes iris scissors	61		
O			
Oehler tissue forceps	66		
Olsen-Hegar needle holder/scissors	51		
Operating scissors	58		
Orthodontic spanner	112		
P			
Paper filter	147		
Paper label with indicator	147		
Parodontological probe	97		
Peers towel forceps	49		
Plaster knife	121, 122		
Plaster scissors	56		
Plaster spatula	121		
Plastic filling instrument	85, 86, 88		
Plastic filling instrument – carrier	79		
Plastic filling instrument – plugger	80–82		
Plastic filling instrument – spatula	85, 86, 88		
Plastic filling instrument – spatula-plugger	84		
Plastic hook	33		
Plastic security seal	147		
Plastic test stick	101		
Prefabricated plate	55		
Přecechtěl nasal raspatory	26		
Q			
Quinby gum scissors	57		
Quiver for forceps	138		
Quiver for tweezers	138		
R			
Rasp	27		
Resection hook	35		
Rest of crown flask	128		
Retentive fibre instrument	83		
Reynolds dissecting scissors	59		
Roeder towel forceps	49		
Rochester-Pean artery forceps	47		
Root elevator straight left	23–25		
Root suppository forceps	63		
Roser-König mouth retractor	37		
Ryder needle holder	51		
S			
Safety lid	144		
Sanvenero dissecting scissors	59		
Sapin modelling instrument	87		
Scaler	74, 102–104		
Scaler double-faced	100, 101		
Scalpel handle	43, 125		
Scissors	60		
Seal for sterilizing containers	147		
Semken dissecting forceps	66		
Separative strip diamond	89		
Separative strip smooth	89		
Septum nasal elevator	20		
Set for dental technicians	122		
Set of basic stomatological instruments	74		
Set of impression perforated trays	134		
Set of modelling instruments	125		
Set of parodontological instruments	100		
Sharp spoon	40		
Sharpening stone for curretes	101		
Schlemmer root elevator	23		
Silicon mat	148		
Small set container	146		
Spanner	43		
Spatula – filling instrument	84–86		
Standard operating scissors	58, 59		
Stellbrink bone rongeurs	16		
Sterilization box	139		
Sterilization drum	142, 143		
Strip clamp	89		
Surgical mallet	30		
Špinar root elevator	24		
T			
Teflon filter	147		
Textile filter	147		
Tissue forceps	64, 65, 125		
Tohoku-Japan towel forceps	49		

Tray	141
U	
Universal retainer	93
W	
Wamkey crown remover	94
Washer for casting rings	129
West gouge grooved	28
Whitehead mouth retractor	38
Wiland amalgam carver	87
Williger elevator	20
Williger raspatory	26
Wire base	144–146
Wire cutting forceps	113

A

Abdrucklöffel	131–134
Abdrucklöffelset	134
Abtrennungsband dia	89
Abtrennungsband glatt	89
Adson Pinzette	66
Amalgampistole	90
Anatomische Pinzette	64, 65, 125
Anzugsschlüsse	43
Augenhaken	33
Augenschere	60

B

Babcock Darmfasszange	47
Backhaus Papierklemme	48
Backhaus Tuchklemme	48
Barry Wurzelheber	25
Bein Wurzelheber	21, 22
Black Schmelztmesser	106, 107
Black Zahnreiniger	104
Blumenthal Knochenkneifzange	16
Boden gelocht	144–146
Boden ungelocht	144–146
Boynton-Eye Nadelhalter	50
Brünnings Zungenspatel	72
Bügel für Küvetten	127
Buchwald Zungenspatel	72

C

Castroviejo Iridektomieschere	61
Castroviejo Mikro-Federschere	61
Castroviejo Mikro-Nadelhalter	53
Castroviejo Nadelhalter	53
Chirurgische Pinzette	65
Cleveland Knochenkneifzange	16
Collin Zungenhalterzange	19
Container ½	144
Criile Nadelhalter	50, 52
Cushing Wundhaken	32

D

Deckel gelocht	144–146
Deckel geschlossen	144–146
Dental container	145
Dentalplatte	141
Dentalschienungsplatte	55
Desmarres Wundhaken	32
Dieffenbach Augenskallpell	42
Discoid-Cleoid Füllungsinstrument	88
Dose	140, 142
Dose für Zahnprothese	142
Drahtkneifzange	113

E

Exkavator	77
Exkavator beiderseitig	74, 78

F

Feile dia	108
Feiner Wundhaken	31
Filter	147
Flachmeißel	28
Flohr Wurzelheber	22
Frahm Modellierinstrument	87

Freer Septum-elevator	20
Friedman Knochenkneifzange	16
Führungsinstrument für Retraktionsfiber	83
Füllungsinstrument	79, 83–85, 88
Füllungsinstrument beiderseitig	80–82, 85, 86
Furkations-kürette	101

G

Gelenke zu KFO Schraube	112
Gießring	129, 130
Gillies Chirurgische Pinzette	66
Gingivalrandschräger	104
Gingivektomie-Messer	41
Gipssmesser mit Küvettenöffner	121, 122
Gipsspatel	91, 121
Gitter	130
Goldman-Fox Schere	57
Gomel Mikro-schere	62
Gracey Kürette	98, 100
Graefe Fixierpinzette	67
Graefe Irispinzette	67

H

Halbkeilmeißel	29
Halsted-Mosquito Arterienklemme	46
Hartmann arterienklemme	46
Heidemann Füllungsinstrument	86
Heister Mundsperrer	37
Heywood-Smith Schwammzange	19
Hohlmeißel	29
Hohlmeißelzange	18

I

Indikatorschilder aus Papier	147
Instrumentenhalter für 5 Instrumente	74, 139
Intra-oral-Haken	36
Ivory Matrizenbänder	92
Ivory Matrizenspanner	92
Ivory Separator	92

J

Jacobson Mikro-Nadelhalter	53
Jansen Ohrkneifzange	17
Jennings Mundsperrer	38
Jeweler Pinzette	66
Joseph feiner Wundhaken	31
Joseph Nasenfeile	27

K

Kassette	139
Kassette für 5 Instrumente	74, 139
Kelly Arterienklemme	47
Kennzeichnungsschilder	147
KFO Schraube	111, 112
KFO Schraube zu fächerförmiger Expansion	112
Kinder-Zahnzange	15
Kinderabdrucklöffelset	134
Klein set container	146
Kramponzange	114, 122
Kronenabdrucklöffel	132
Kronenabnehmer	94
Kronenküvette	128
Kronenküvettenstütze	128
Kronenschere	120

L

Laborlöffel	121
Laborpinzette	68, 119
Laborzange	114–116
Langenbeck Elevator	20
Langenbeck Fingerschützer	37
Langenbeck Raspatorium	26
Langenbeck Wundhaken	33
Le Cron Modellierinstrument	122, 123
Lecluse Wurzelheber	25
Lister Verbandschere	56
Liston Hohlmeißelzange	18
Löbker Zungenhalterzange	19
Lorna Tuchklemme	49
Luer Hohlmeißelzange	17
Luer Knochenkneifzange	16
Luniatschek Tamponstopfer	54

M

Mathieu Nadelhalter	50, 52
Matrizenband	93
Matrizenspanner	89, 93
Messingverteiligküvette	128
Metallhammer	30, 126
Metallskalpelgriff	43
Micro-Mosquito Arterienklemme	46
Middeldorpf Wundhaken	34
Mikroschere	62
Mini Gracey Kürette	99, 100
Mini-Friedman Knochenkneifzange	16
Mini-Langenbeck Wundhaken	32
Modellierinstrument	87, 124, 125
Modellierinstrumenten-satz	125
Mosquito-Halsted Arterienklemme	45, 122, 125
Muffelringformer	129
Muffelzange	113
Mundspiegel	73, 74
Mundspiegelgriff	73, 74

N

Nabers Furkationssonde	97
Nadelhalter	51
Nadelhalter mit Schloss	50
Nasenelevator	20
Nasenfeile	27
Nasenmeißel	28
Noppenmatte Silikon	148
Noyes Iridektomieschere	61

O

Oehler Hakenpinzette	66
Olsen-Hegar Nadelhalter/Schere	51

P

Parodontometer	97
Peers Tuchklemme	49
Pinzette gekreuzt	68, 119
Pinzette gekreuzt mit Schraubenzieher	68, 119
Plastikhaken	33
Platte	141
Precechtěl Nasenraspatorium	26

Q

Quinby Zahnfleischschere	57
--------------------------	----

R

Resektionshaken	35
Reynolds Praeparierschere	59
Roeder	49
Rochester-Pean Arterienklemme	47

Roser-König Mundsperrer	37
Ryder/French-Eye Nadelhalter	51

S

Sägeblatt	120
Sägebügel	120
Sanvenero Praeparierschere	59
Sapin Modellierinstrument	87
Satz der dental Instrumenten	74
Satz der Parodontologie-Instrumenten	100
Semken Pinzette	66
Servittenthalter mit Kette	137
Set für Zahntechniker	122
Scharfe Löffel	40–41
Scharfe Löffel beiderseitig	39
Schleifstein zum nachschärfen	101
Schlemmer Wurzelheber	23
Schlüssel für KFO Schrauben	112
Schüssel	139
Siebeinlage	146
Siebcorp	144–146
Sicherheitsdeckel	144
Sicherheitsverschluss Plastik	147
Skalpellgriff	43, 125
Skalpellschlingen	44
Sonde	97
Spannrahmen	144–146
Spatel für Abdruckmassen	91, 121
Spinar Wurzelheber	24
Standard chirurgische Schere	58, 59
Standgefäß für Pinzetten	138
Standgefäß für Zangen	138
Stellbrink Knochenkneifzange	16
Sterilisationstrommel	142, 143
Sterilisierdose	139

T

Teiler	144
Teststäbchen aus Kunststoff	101
Tohoku-Japan Tuchklemme	49
Tränensack-raspatorium	26
Tuch Grün	148
Tuchklemme mit Schlauchhalter	48

V



















Verbandschere	56
Viertelgküvette	128

W

Wachsmesser	122, 123
Wamkey Kronenabnehmer	94
Wattebehälter	137
Wattemüllbehälter	137
West Hohlmeißel	28
White Wurzelheber	24, 25
Whitehead Mundsperrer	38
Wiland Schnitzinstrumente	87
Williger Elevator	20
Williger Raspatorium	26
Wundhaken	31
Wurzelheber	23, 25
Wurzelkanal-Zange	15

Z

Zahnfleischmesser	41
Zahnfleischschere	57
Zahnpinzette gerieft	63, 74, 122
Zahnreiniger	74, 102–105
Zahnreiniger doppelseitig	100, 101
Zahnsonde	71, 74
Zahnzange	11–14

	použit do	use by	Verwendbar bis
	datum výroby	date of manufacture	Herstellungsdatum
	výrobce	manufacturer	Hersteller
	nepoužívat znovu	do not reuse	Nicht zur Wiederverwendung
	neprovádět opětovnou sterilizaci	do not resterilize	Nicht erneut Sterilisieren
	nepoužívat, jestliže je balení poškozeno	do not use if package is damaged	Inhalt beschädigter Packung nicht verwenden
	otevřené balení nebude nahrazeno	opened packages are not replaced	Aufgebrochene Verpackung, nicht ersetzbar
	set, souprava	assortment	Sortiment
	pozor sledujte průvodní dokumentaci	caution, consult accompanying documents	Siehe Gebrauchsanweisung
	nesterilní	non sterile	Unsteril
	doporučené otáčky za minutu, doporučená frekvence otáčení XXX-XXX min ⁻¹	recommended rotation speed	Empfohlene Umdrehungsgeschwindigkeit
	kód dávky	batch code	Chargenbezeichnung
	katalogové číslo	catalogue number	Artikel Nummer
	množství	quantity	Menge
	kontrola	control	Kontrolle
	sterilní	sterile	Steriles Produkt
	sterilizace ozářením	sterilization using irradiation	Sterilisationsanwendung mit ionischer Bestrahlung
	sterilizace ethylenoxidem	sterilization using ethylene oxide	Sterilisationsanwendung mit Ethylenoxid
	sterilní zdravotnické prostředky zpracované aseptickou technologií	sterile by aseptic techniques	Zeichen für Sterilität bei aseptischer Abfüllung als Herstellungsverfahren
	diagnostický zdravotnický prostředek in vitro	in vitro diagnostic medical device	Medizinisches In-vitro-Diagnostikum
	globální nomenklatura zdravotnických prostředků	global medical device nomenclature code	Global Medical Device Nomenclature Nummer
	sledujte návod k použití	consult instructions for use	Gebrauchsanweisung beachten

- ▶ CHIRURGIE / SURGERY
- ▶ TRAUMATOLOGIE / TRAUMATOLOGY
- ▶ ORTOPEDIE / ORTHOPAEDICS
- ▶ STOMATOLOGIE / DENTISTRY
- ▶ STERILIZACE / STERILIZATION
- ▶ LAPAROSKOPIE / LAPAROSCOPY
- ▶ ENDOSKOPIE / ENDOSCOPY
- ▶ ARTROSKOPIE / ARTHROSCOPY



kompletní nabídka lékařských nástrojů a implantátů na
full range of medical instruments and implants on

▶ www.medin.cz

© 2010 MEDIN, a.s.; Všechna práva vyhrazena.

Dokument je určen pro obchodní účely MEDIN, a.s., údaje zde uvedené jsou informativního charakteru. Žádná část tohoto dokumentu nesmí být reprodukována nebo publikována v jakékoliv formě bez předchozího souhlasu MEDIN, a.s. Zobrazení produktů odpovídá aktuálnímu stavu v době vydání tohoto dokumentu. Změny technických parametrů z důvodu dalšího vývoje jsou vyhrazeny. Tiskové a typografické chyby jsou vyhrazeny.

© 2010 MEDIN, a.s.; All rights reserved.

This document should be used for commercial purposes of MEDIN, a.s.; the data mentioned in the document has informative character. No part of this document can be copied or published in any form without approval of MEDIN, a.s. The product design may differ from those depicted in these illustrations at the date of issue. Adjustments, made from the reason of further developments of technical parameters, are reserved. Printing and typographical errors are reserved.

© 2010 MEDIN, a.s.; Alle Rechte vorbehalten.

Das Dokument ist für gewerbliche Zwecke der MEDIN, a.s. bestimmt, die hier angegebenen Angaben haben informellen Charakter. Kein Teil dieses Dokumentes, egal welcher Form, darf ohne vorherige Zustimmung der MEDIN, a.s. vervielfältigt oder veröffentlicht werden. Die Abbildung der Produkte entspricht dem aktuellen Stand der Herausgabe dieses Dokumentes. Änderungen der technischen Parameter sind aus Gründen der Weiterentwicklung vorbehalten. Druck- und typographische Fehler sind vorbehalten.

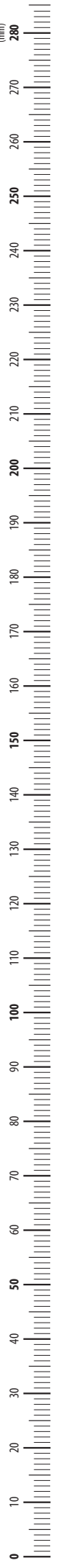

MEDIN, a.s.

Vlachovická 619
Nové Město na Moravě
CZ 592 31
Czech Republic
IČO 43378030
DIČ CZ43378030

CENTRÁLA

tel.: 566 684 111

PRODEJ ČESKÁ REPUBLIKA

tel.: 566 684 327
fax: 566 684 384
e-mail: prodej@medin.cz

PRODEJNA PRAHA

Jana Želivského 6
Praha 3
CZ 130 00
tel./fax: 222 592 334
mobil: 606 686 530

PRODEJ SLOVENSKÁ REPUBLIKA

tel.: +420 566 684 332
fax: +420 566 684 385
e-mail: export@medin.cz

EXPORT

phone: +420 566 684 336
fax: +420 566 684 385
e-mail: export@medin.cz

www.medin.cz

**NÁSTROJE PRO STOMATOLOGII
INSTRUMENTS FOR DENTISTRY
DENTAL INSTRUMENTE**

2010

