

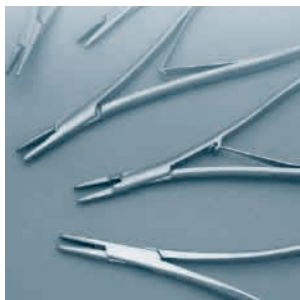

NÁSTROJE PRO ORL
INSTRUMENTS FOR ENT

OTORINOLARYNGOLOGIE – OTORHINOLARYNGOLOGY

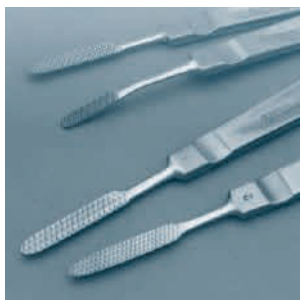

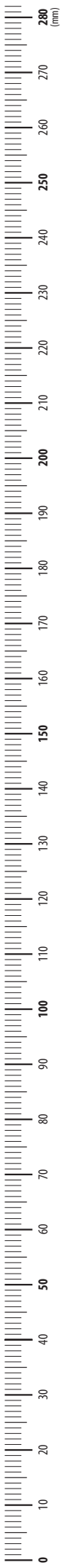

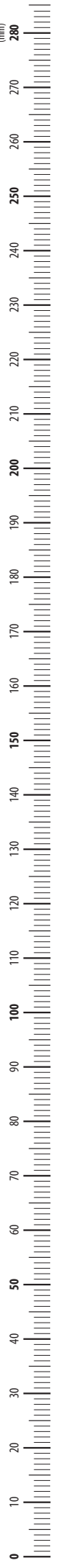



MEDIN, a.s.

Vlachovická 619
Nové Město na Moravě
CZ 592 31
Czech Republic
IČO 43378030
DIČ CZ43378030

CENTRÁLA

tel.: 566 684 111

PRODEJ ČESKÁ REPUBLIKA

tel.: 566 684 327-8
fax: 566 684 384
e-mail: prodej@medin.cz

PRODEJNA PRAHA

Jana Želivského 6
Praha 3
CZ 130 00
tel./fax: 222 592 334
mobil: 606 686 530

PRODEJ SLOVENSKÁ REPUBLIKA

tel.: +420 566 684 332
fax: +420 566 684 385
e-mail: export@medin.cz

EXPORT

phone: +420 566 684 336
fax: +420 566 684 385
e-mail: export@medin.cz

www.medin.cz





Certifikát EN ISO 13485
Certificate EN ISO 13485

CE 0434

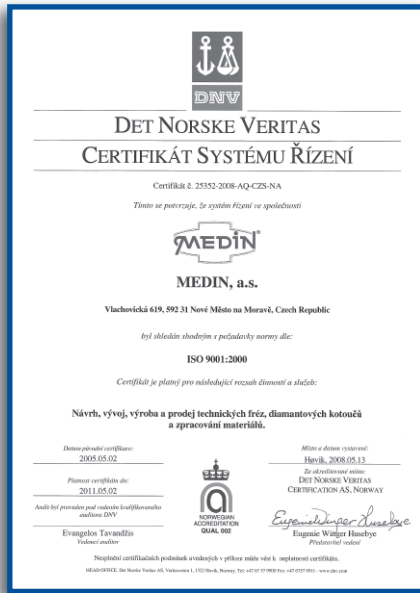

Certifikát ISO 9001
Certificate ISO 9001



Certifikát ISO 14001
Certificate ISO 14001

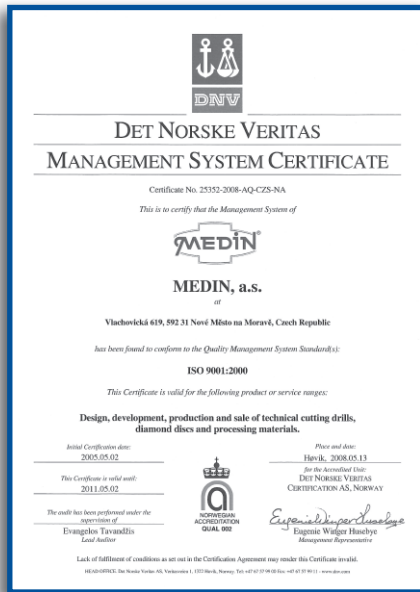

Akciová společnost MEDIN se sídlem v Nové Městě na Moravě zahájila činnost 4. 5. 1992 jako právní nástupce bývalého státního podniku Chirana Nové Město na Moravě.

MEDIN, a.s., je největší český výrobce nástrojů pro humánní lékařství ve všech hlavních oborech lékařských specializací včetně kostní chirurgie a implantátů pro traumatologii a ortopedii. Zároveň je největším českým výrobcem dentálních nástrojů jak ordinálních, tak rotačních.

Dlouholetá tradice výroby lékařských nástrojů, začínající již v roce 1949, vytvořila know-how umožňující dodávat výrobky vysoké kvality s ohledem na dosažení vysoké míry bezpečnosti odpovídající vysoké úrovni ochrany zdraví. Úroveň, kvalita a bezpečnost všech nástrojů je pečlivě posuzována. Akcent na kvalitu a bezpečnost nástrojů je tradičně zakotven ve firemní politice jakosti a strategii firmy. V kvalitě používá firma účinných postupů dle mezinárodních norem *ISO 9001 Systémy managementu kvality* a *ISO 13485 Systémy jakosti – Zdravotnické prostředky*, jejichž certifikáty jsou pravidelně obnovovány. Důležitou oblastí je splnění legislativních podmínek při uvádění výrobků na trh, zejména evropské direktivy Medical Device 93/42/EHS.

MEDIN, a.s., uplatňuje aktivní postoj k ochraně životního prostředí a praktickou činností směřuje k minimalizaci dopadů vlivů firemních činností na životní prostředí. Komplex výrobních, pomocných a administrativních prostor společnosti splňuje použitými technologiemi a energetickými zdroji přísná ekologická hlediska. Prostřednictvím profesně i odborně způsobilých pracovníků trvale udržuje šetrný vztah k životnímu prostředí. Environmentální management firmy je udržován v souladu s mezinárodní normou *ISO 14001 Systémy environmentálního managementu*.

MEDIN, the joint-stock company, having its headquarters in Nové Město na Moravě commenced its activity on May 4, 1992 as a legal successor of the former state-owned enterprise Chirana Nové Město na Moravě.

MEDIN, the joint-stock company, is the greatest Czech producer of instruments for human medicine in all main fields of medical specialisations, including the bone surgery and implants for traumatology and orthopaedics. It is also the biggest producer of surgery and rotary dental instruments.

A long standing tradition of surgical instruments production, founded as early as 1949, has established a know-how that enables to provide products of high quality and safety corresponding to high level of health protection. The standards, quality and safety of all instruments are carefully evaluated. The quality and safety of the instruments are traditionally anchored in the company's quality policy and company's strategy. We use the effective procedures according to the International Standard *ISO 9001 – Systems of quality management* and *ISO 13485 Quality Systems – Medical Instruments* whose certificates are regularly renewed. It is also very important to follow the legislative conditions when launching the products on the market, mainly the European Directive Medical Devices 93/42/EEC.

MEDIN, the joint-stock company, cares about the environment actively and minimises the impacts of the company's activity on the environment. The complex of production, auxiliary and administration buildings of the company meets the strict environmental aspects with the applied technologies and energy sources.

We permanently keep a considerate relation with our environment through our professionals and specialists. The Environmental management of the company is in conformity with *ISO 14001 – Systems of environmental management*.



397 111 Diagnostika	Diagnostic	9–24
397 112 Nástroje řezné	Cutting Instruments	25–44
397 113 Nůžky	Scissors	45–66
397 114 Pinzety	Forceps	67–76
397 115 Svorky	Clamps, Forceps	77–86
397 116 Kleště štípací	Cutting Forceps	87–108
397 117 Kleště úchopné	Grasping Forceps	109–121
397 118 Háky	Hooks, Retractors	123–135
397 119 Rozvěrače	Retractors	137–145
397 121 Lopatky	Spatulas	147–150
397 122 Zrcadla	Specula	151–160
397 123 Páčidla	Elevators	161–167
397 124 Škrabky	Raspatories	169–172
397 125 Lžičky	Bone Curettes	173–176
397 126 Kyrety	Curettes	177–188
397 127 Pilky, Pilníky	Saws, Files	189–196
397 128 Dláta, Kladiva	Chisels, Mallets	197–206
397 131 Frézy, Vrtáky	Drills, Burs	207–209
397 132 Jehly, Jehelce	Needles, Needle Holders	211–218
397 133 Pátradla	Probes	219–224
397 134 Trokary, Odsávačky	Trocars, Suction Tubes	225–232
397 136 Nástroje speciální	Special Instruments	233–241
397 146 Nástroje diamantované	Diamond Instruments	243–245
Číselný rejstřík	Numerical Index	247–272
Jmenný rejstřík	Alphabetical Index	273–282







BARANY
111 91 0159
9,6 cm

LADIČKY
TUNING FORKS**HARTMANN**

111 91 0111	C	128
111 91 0112	C ¹	256
111 91 0113	C ²	512
111 91 0114	C ³	1024
111 91 0115	C ⁴	2048
111 91 0116	C ⁵	4096

**LUCAE**

111 91 0117	C	128
111 91 0118	C ¹	256
111 91 0119	C ²	512
111 91 0120	C ³	1024
111 91 0121	C ⁴	2048
111 91 0122	C ⁵	4096

**HARTMANN-FRENCH**

111 91 0123	C ²	16
111 91 0124	C ²	32
111 91 0125	C	64
111 91 0126	C	128
111 91 0127	C ¹	256

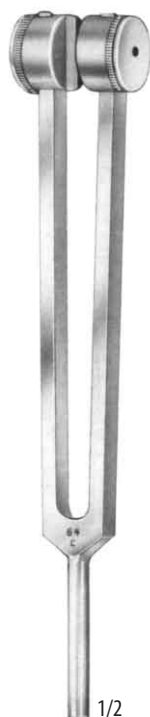
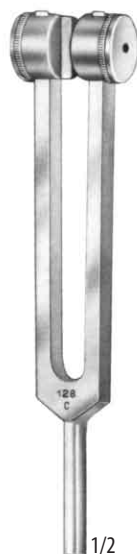
LADIČKY HLINÍKOVÉ
TUNING FORKS ALUMINIUM**111 91 0131**
C 64**111 91 0132**
C 128**111 91 0133**
C 256**111 91 0134**
C 512**111 91 0135**
C 1024**111 91 0136**
C 2048**111 91 0137**
C 4096



111 91 0128
 sada – set
111 91 0113
111 91 0114
111 91 0115
111 91 0126
111 91 0127

111 91 0129
 sada – set
111 91 0113
111 91 0114
111 91 0115
111 91 0116
111 91 0126
111 91 0127

111 91 0130
 sada – set
111 91 0113
111 91 0114
111 91 0115
111 91 0116
111 91 0124
111 91 0125
111 91 0126
111 91 0127

LADIČKY HLINÍKOVÉ – SADY
TUNING FORKS ALUMINIUM – SETS

111 91 0138
 sada – set
111 91 0132
111 91 0133
111 91 0134
111 91 0135
111 91 0136

VZDUCHOVÝ SÁČEK
AIR BAG

1/2



1/2



1/2

POLITZER

111 91 0139
komplet – complete
111 91 0140
111 91 0141
111 91 0142
111 91 0143
111 91 0144

111 91 0140**111 91 0144**

111 91 0141
111 91 0142
111 91 0143

průměr – diameter

15 mm

17 mm

22 mm

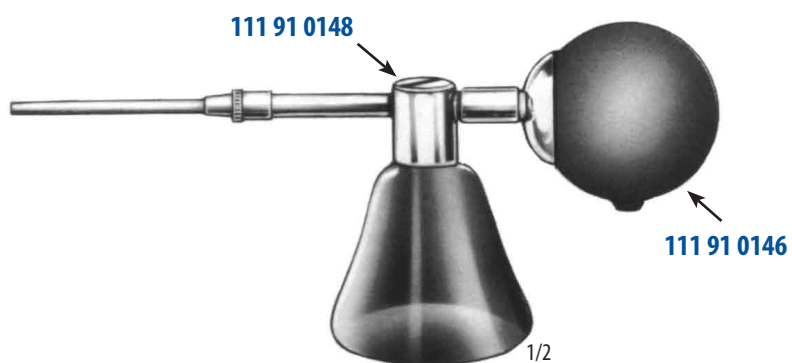
ZAPRAŠOVAČ
POWDER BLOWER
**111 91 0148****111 91 0146**

1/2

KABIERSKE

111 91 0145
komplet – complete
111 91 0146
111 91 0147
111 91 0148
111 91 0149
111 91 0150
111 91 0151

111 91 0147
30 ccm



1/2

111 91 0149
8,0 cm



1/2

111 91 0150
11,0 cm

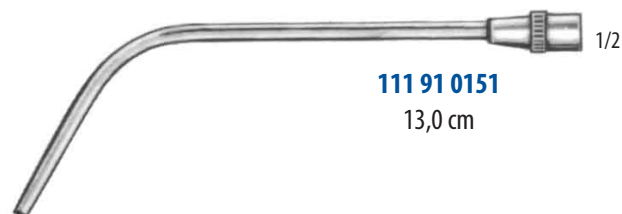

1/2

111 91 0151
13,0 cm



111 91 0003
Fig. 0
55 mm



111 91 0004
Fig. 1
75 mm



111 91 0005
Fig. 2
90 mm



111 91 0006
Fig. 3
110 mm



111 91 0007
Fig. 4
135 mm



McINTOSH
komplet – complete

111 91 0001 (90 mm + 110 mm + 135 mm)
111 91 0002 (75 mm + 90 mm + 110 mm + 135 mm)

**111 91 0010**Fig. 0
70 mm**111 91 0011**Fig. 1
95 mm**111 91 0012**Fig. 2
110 mm**111 91 0013**Fig. 3
140 mm**111 91 0014**Fig. 4
170 mm**FOREGGER (WISCONSIN)**

komplet – complete

111 91 0008

(110 mm + 140 mm + 170 mm)

111 91 0009

(95 mm + 110 mm + 140 mm + 170 mm)



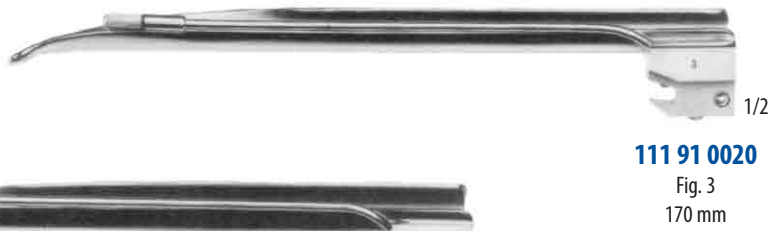

MILLER

komplet – complete

111 91 0015 (130 mm + 170 mm + 180 mm)
111 91 0016 (80 mm + 130 mm + 170 mm + 180 mm)



1/2

111 91 0022
průměr – diameter
19 mm



1/2

111 91 0023
průměr – diameter
28 mm



1/2

111 91 0024
průměr – diameter
37 mm



1/2

111 91 0025



1/1

111 91 0026
Fig. 2 – 4



1/1

111 91 0027
Fig. 0 – 1



McINTOSH
 STUDENÉ SVĚTLO
 komplet – complete

111 91 0028
111 91 0029

(80 mm + 105 mm + 130 mm)
 (70 mm + 80 mm + 105 mm + 130 mm)



111 91 0030	Fig. 0	55 mm
111 91 0031	Fig. 1	70 mm
111 91 0032	Fig. 2	80 mm
111 91 0033	Fig. 3	105 mm
111 91 0034	Fig. 4	130 mm



FOREGGER (WISCONSIN)
STUDENÉ SVĚTLO
komplet – complete

111 91 0035 (110 mm + 140 mm + 170 mm)
111 91 0036 (95 mm + 110 mm + 140 mm + 170 mm)



1/2



111 91 0037	Fig. 0	70 mm
111 91 0038	Fig. 1	95 mm
111 91 0039	Fig. 2	110 mm
111 91 0040	Fig. 3	140 mm
111 91 0041	Fig. 4	170 mm



MILLER
 STUDENÉ SVĚTLO
 komplet – complete

111 91 0042 (80 mm + 130 mm + 170 mm)
111 91 0043 (80 mm + 130 mm + 170 mm + 180 mm)



111 91 0044	Fig. 0	55 mm
111 91 0045	Fig. 1	80 mm
111 91 0046	Fig. 2	130 mm
111 91 0047	Fig. 3	170 mm
111 91 0048	Fig. 4	180 mm

LARYNGOSKOPY SE STUDENÝM SVĚTLEM
FIBRE OPTIC LARYNGOSCOPES

111 91 0049
průměr – diameter
30 mm



111 91 0050
průměr – diameter
20 mm



1/2
111 91 0051
2,5 V
Halogen



1/2
111 91 0052
2,5 V
Krypton



111 91 0066
komplet – complete

111 91 0067
NÁHRADNÍ ŽÁROVKA
SPARE LAMP



111 91 0068 90 mm
111 91 0069 100 mm



CLAR 55
111 91 0070
6V



CLAR STANDARD
111 91 0071
6V







112 91 0002
12,3 cm

112 91 0003
12,3 cm

112 91 0004
13,3 cm

112 91 0005
20,5 cm

112 91 0006
20,5 cm

112 91 0007
16,5 cm

COLLIN
112 91 0008
13,3 cm

SKALPELOVÉ ČEPELKY STERILNÍ, DRŽÁTKO SKALPELOVÝCH ČEPELEK
SCALPEL BLADES STERILE, SCALPEL HANDLE

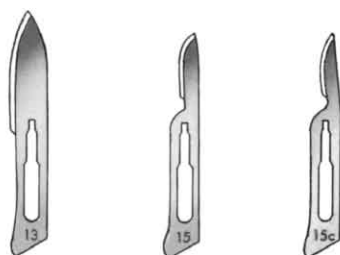

112 91 0010 Fig. 10 **112 91 0011** Fig. 11 **112 91 0012** Fig. 12 **112 91 0025** Fig. 12d



112 91 0013 Fig. 13 **112 91 0015** Fig. 15 **112 91 0026** Fig. 15c

pro držátka – for handles

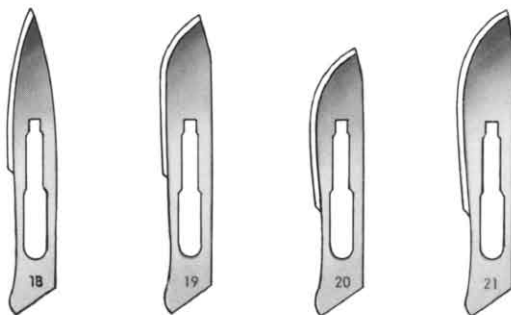
112 91 0002; 112 91 0003; 112 91 0005; 112 91 0007; 112 91 0008
sterilní, balení 100 ks – sterile, packing 100 pcs



112 91 0018 Fig. 18 **112 91 0019** Fig. 19 **112 91 0020** Fig. 20 **112 91 0021** Fig. 21

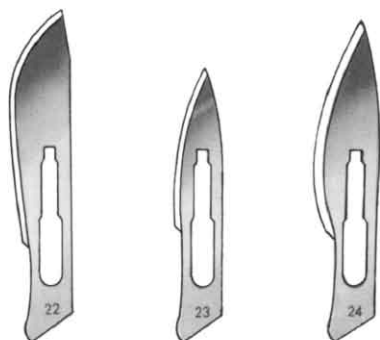

112 91 0022 Fig. 22 **112 91 0023** Fig. 23 **112 91 0024** Fig. 24

pro držátka – for handles

112 91 0004; 112 91 0006
sterilní, balení 100 ks – sterile, packing 100 pcs



1/1

DRŽÁTKO SKALPELOVÝCH ČEPELEK
SCALPEL HANDLE

112 08 0696

15,0 cm



1/1

UTAHOVACÍ KLÍČEK
SPANNER

112 08 0700

8,0 cm

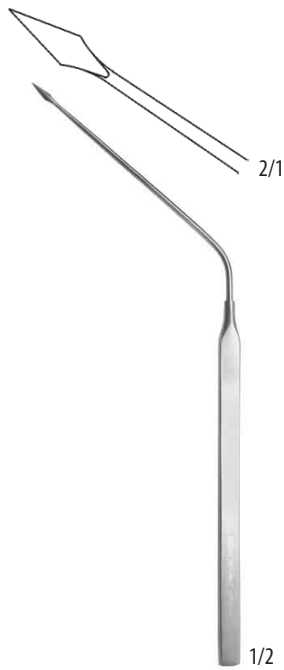

AGNEW
112 29 0010
15,7 cm



SCHWARTZE
112 29 0020
15,7 cm

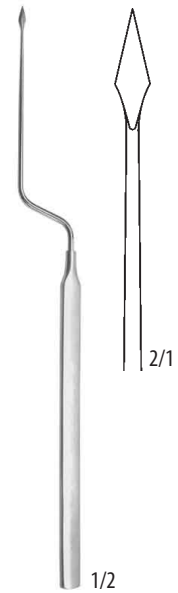

LUCAE
112 29 0040
17,5 cm



POLITZER
112 91 0120
16,5 cm



POLITZER
112 91 0121
17,0 cm



BARBARA
25°

112 91 0129 0,3 mm
112 91 0130 0,6 mm
112 91 0131 1,0 mm



SHAMBAUGH
45°

112 91 0132 0,3 mm
112 91 0133 0,6 mm
112 91 0134 1,0 mm
112 91 0135 1,2 mm
112 91 0136 1,5 mm
112 91 0137 2,0 mm
112 91 0138 2,5 mm



SHAMBAUGH
90°

112 91 0139 0,3 mm
112 91 0140 0,6 mm
112 91 0141 1,0 mm
112 91 0142 1,2 mm
112 91 0143 1,5 mm
112 91 0144 2,0 mm
112 91 0145 2,5 mm



BARBARA

112 91 0146 0,6 mm
112 91 0147 1,0 mm



16,0 cm



BARBARA
112 91 0148



BARBARA
112 91 0149



BARBARA
112 91 0150



ROSEN
112 91 0151



25°

112 91 0152 0,3 mm
112 91 0153 0,6 mm
112 91 0154 1,0 mm



45°

112 91 0158 0,3 mm
112 91 0159 0,6 mm
112 91 0160 1,0 mm



90°

112 91 0164 0,3 mm
112 91 0165 0,6 mm
112 91 0166 1,0 mm



16,0 cm



25°

112 91 0155 0,3 mm
112 91 0156 0,6 mm
112 91 0157 1,0 mm



45°

112 91 0161 0,3 mm
112 91 0162 0,6 mm
112 91 0163 1,0 mm



90°

112 91 0167 0,3 mm
112 91 0168 0,6 mm
112 91 0169 1,0 mm



McGEE

112 91 0170 0,5 mm
112 91 0171 1,0 mm



McGEE

112 91 0172 0,5 mm
112 91 0173 1,0 mm



BARBARA

112 91 0174 0,5 mm



ROSEN

112 91 0175 0,5 mm

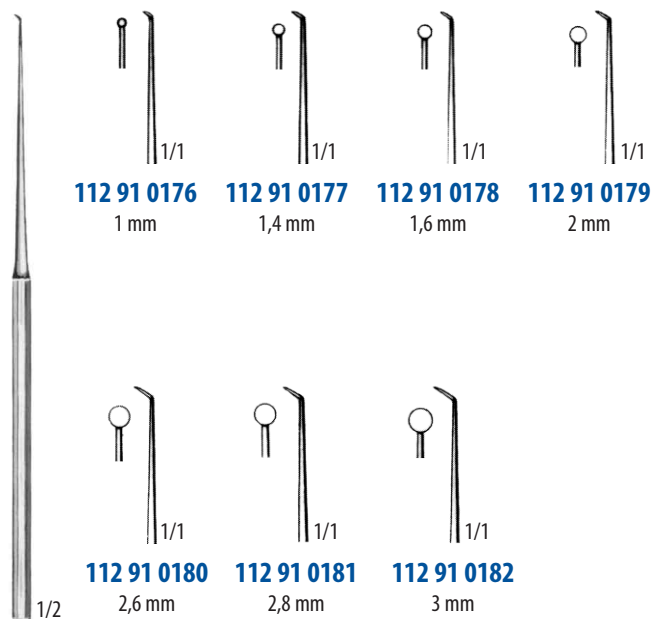

ROSEN
16,0 cm

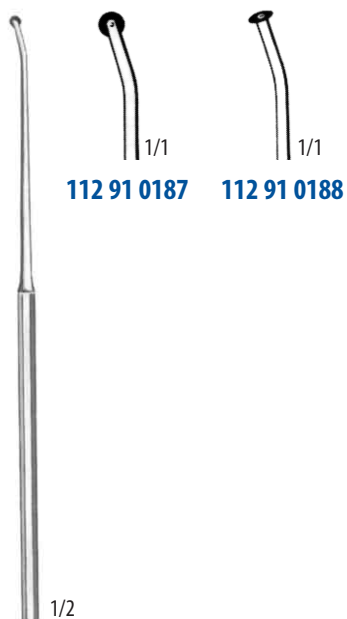
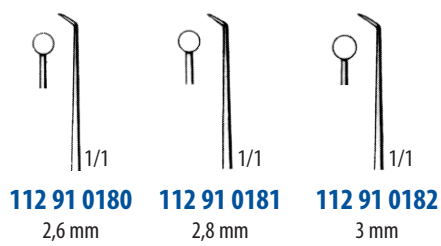

SCHUKNECHT
16,0 cm



WULLSTEIN
112 91 0189
16,0 cm



SCHUKNECHT
112 91 0190
16,0 cm

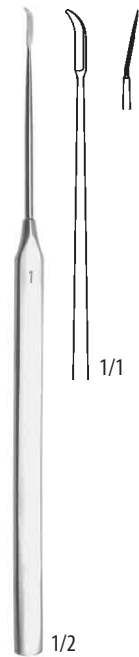

SCHWARTZE
112 29 0120
17,0 cm
Fig. 1

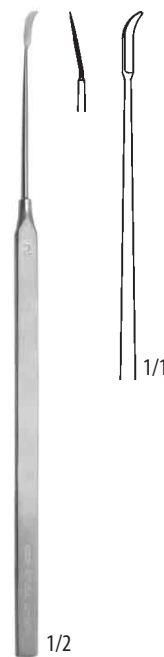

SCHWARTZE
112 29 0130
17,0 cm
Fig. 2

NOŽE NA ZVUKOVOD
SOUNDS KNIVES

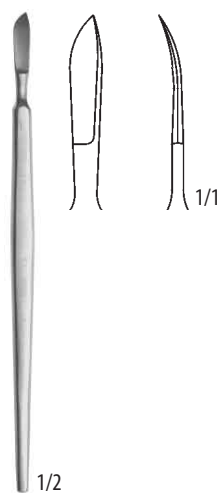

STACKE
112 29 0150
12,6 cm
Fig. 1

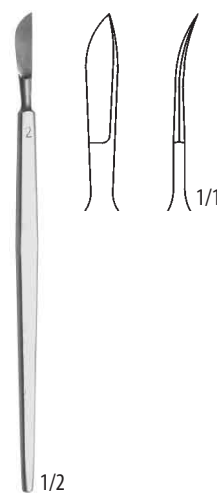

STACKE
112 29 0160
12,6 cm
Fig. 2

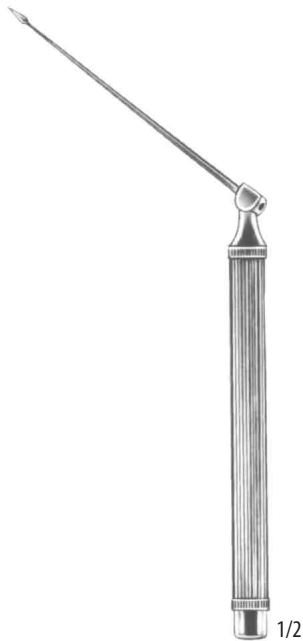
**SPRAGUE****112 91 0122**

soubor – set

**112 91 0123****112 91 0124****112 91 0125****112 91 0126****112 91 0127****112 91 0128**

			počet ks – number of pcs
112 91 0123	JEHLA PARACENTÉSNÍ	PARACENTESIS NEEDLE	1
112 91 0124	NŮŽ	KNIFE	1
112 91 0125	LŽIČKA UŠNÍ	EAR SPOON	1
112 91 0126	SMYČKA UŠNÍ	EAR LOOP	1
112 91 0127	HÁČEK UŠNÍ	EAR HOOK	1
112 91 0128	PÁTRADLO	PROBE	1

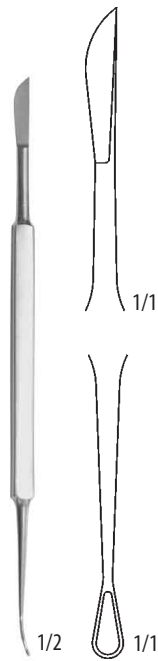

112 29 0100
15,0 cm

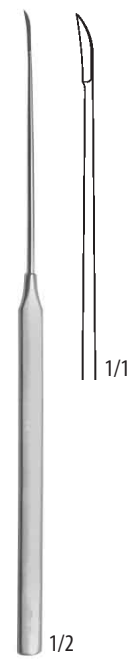

POLITZER
112 29 0110
17,0 cm

NOŽE NA NOSNÍ PŘEPÁŽKU
SEPTUM KNIVES



FREER „D“
112 91 0261
15,0 cm



FREER „E“
112 91 0262
15,0 cm



FREER
112 91 0263
15,0 cm

NOŽE NA NOSNÍ PŘEPÁŽKU
SEPTUM KNIVES**112 30 0260**

Fig. 1

112 30 0270

Fig. 2

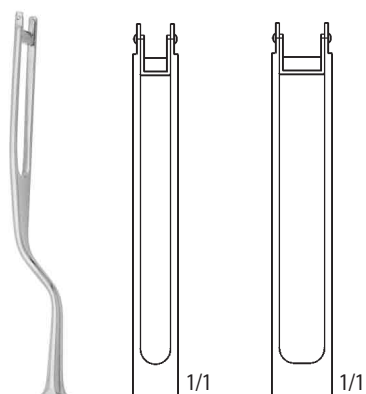

1/2

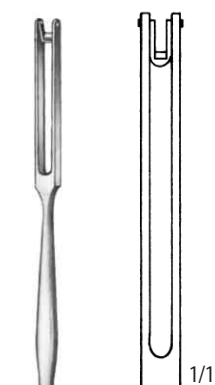
BALLENGER
112 30 0270
20,0 cm**112 91 0268**

3 mm

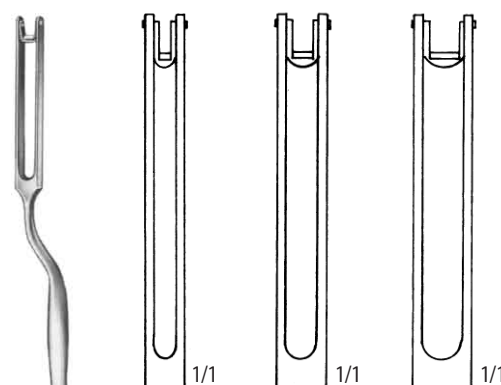

1/2

BALLENGER
112 30 0270
20,0 cm**112 91 0269**3 mm
Fig. 1**112 91 0270**4 mm
Fig. 2**112 91 0271**5 mm
Fig. 3

1/2

BALLENGER
112 91 0271
lomený – angled
20,0 cmNOŽE NOSNÍ
NASAL KNIVES**112 91 0251**

Fig. 1

JOSEPH
14,5 cm**112 91 0252**

Fig. 2

**112 91 0253**

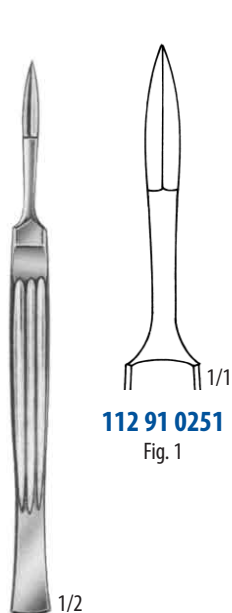
Fig. 1

**112 91 0254**

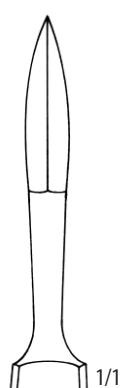
Fig. 2

**FOMON**
112 91 0255
16,0 cm

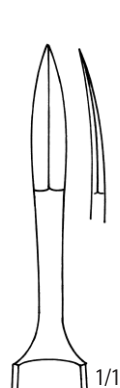

MASING
112 91 0256
13,0 cm

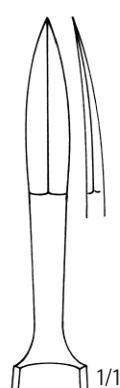
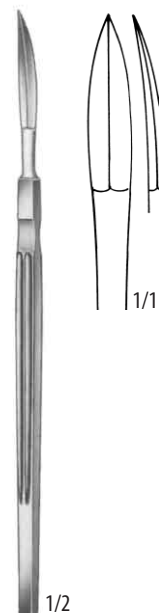

COTTLE
112 91 0257
15,0 cm

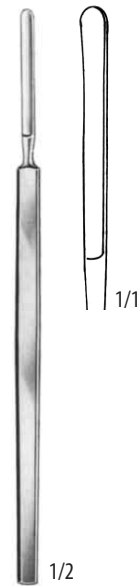

COTTLE
112 91 0258
15,0 cm

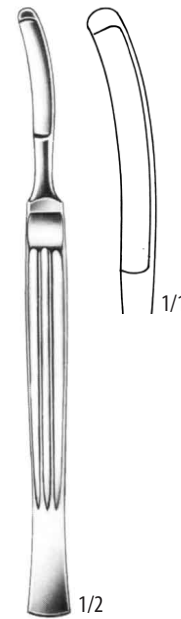

CONVERSE
112 91 0259
16,0 cm



BRUENINGS
112 91 0264
16,0 cm

112 91 0265
náhradní čepelka
spare blade

NOŽE NA NOSNÍ PLASTIKU
NASAL PLASTIC KNIVES



HALLE
112 30 0010
12,0 cm

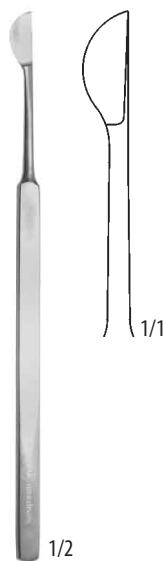

JOSEPH
112 30 0050
14,5 cm

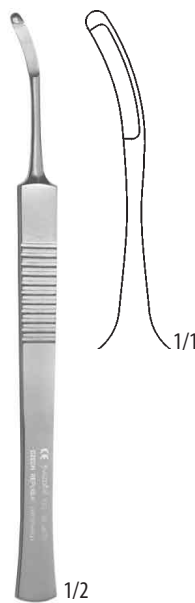

HEYMANN
112 30 0070
15,5 cm

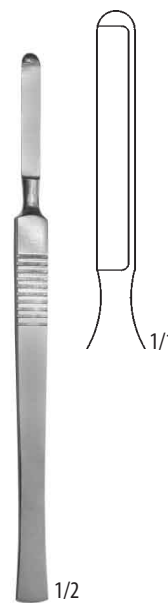

JOSEPH
112 30 0100
14,5 cm

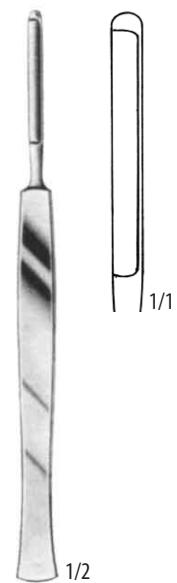

JOSEPH
112 91 0260
15,0 cm



1/2

JOSEPH
112 91 0266
lomený – angled
16,5 cm

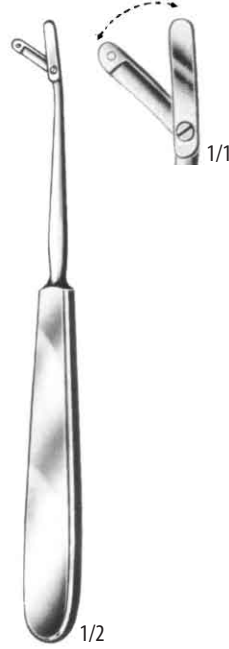

1/1

1/2

MALTZ
112 91 0267
ohebný – malleable
16,5 cm

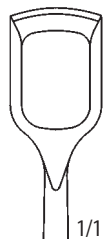

112 30 0300
21,3 cm
Fig. 1

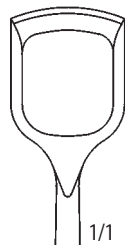

112 30 0310
21,4 cm
Fig. 2

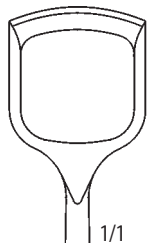

112 30 0320
21,4 cm
Fig. 3

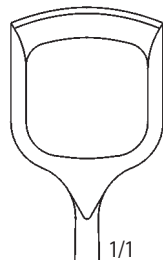

112 30 0330
21,5 cm
Fig. 4



112 91 0274
22,0 cm
Fig. 1

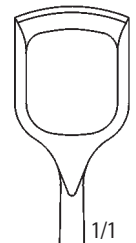

112 91 0275
22,0 cm
Fig. 2



112 91 0272
22,0 cm
Fig. 5



112 91 0273
22,0 cm
Fig. 6

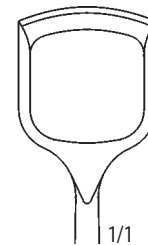

112 91 0276
22,0 cm
Fig. 3

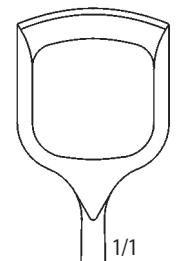

112 91 0277
22,0 cm
Fig. 4



112 91 0278
22,0 cm
Fig. 5

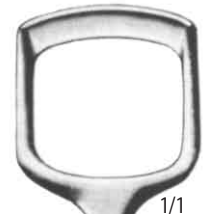

112 91 0279
22,0 cm
Fig. 6



BECKMANN

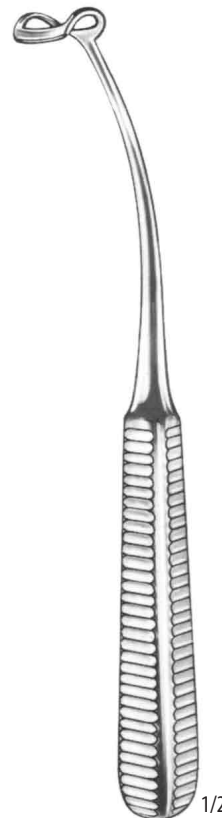

BECKMANN
zahnutá – curved

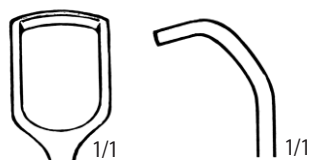
KYRETY NOSOHLTANOVÉ
ADENOID CURETTES**112 91 0280**

22,0 cm

Fig. 1

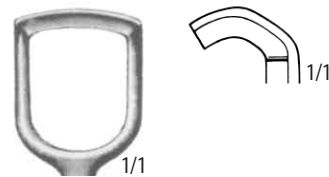
**112 91 0095**

21,0 cm

Fig. 1

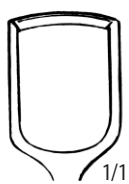
**112 91 0281**

22,0 cm

Fig. 2

**112 91 0096**

21,0 cm

Fig. 2

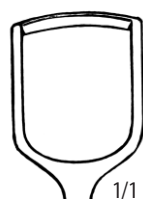
**BARNHILL****112 91 0282**

22,0 cm

Fig. 3

**112 91 0097**

21,0 cm

Fig. 3

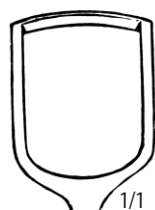
**112 91 0283**

22,0 cm

Fig. 4

**112 91 0098**

21,0 cm

Fig. 4

**ST.CLAIR-THOMPSON**

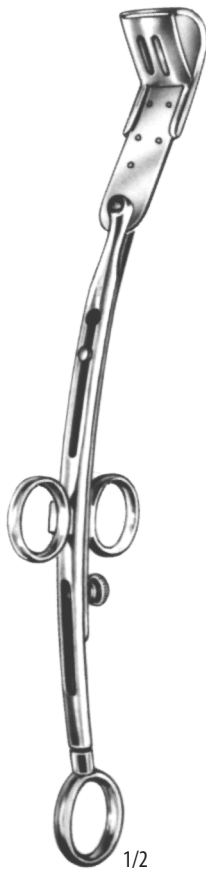

LA FORCE
25,0 cm

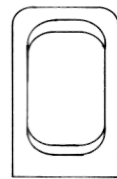

Fig. 1

1/1

112 91 0290

neperforovaná čepel – unperforated blade

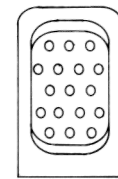

Fig. 4

1/1

112 91 0284

perforovaná čepel – perforated blade

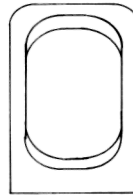

Fig. 2

1/1

112 91 0291

neperforovaná čepel – unperforated blade

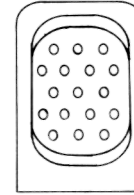

Fig. 5

1/1

112 91 0285

perforovaná čepel – perforated blade

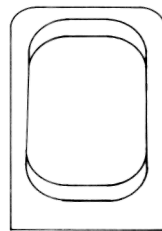

Fig. 3

1/1

112 91 0292

neperforovaná čepel – unperforated blade

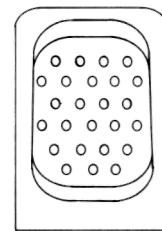

Fig. 6

1/1

112 91 0286

perforovaná čepel – perforated blade

ČEPELE K ADENOTOMU LA FORCE
BLADES FOR ADENOTOM LA FORCE



original Fig. 1

1/1

neperforovaná – unperforated

112 91 0293 Fig. 1

112 91 0294 Fig. 2

112 91 0295 Fig. 3



original Fig. 4

1/1

perforovaná – perforated

112 91 0287 Fig. 4

112 91 0288 Fig. 5

112 91 0289 Fig. 6

ČEPELE K ADENOTOMU LA FORCE-STEVENSON
BLADES FOR ADENOTOM LA FORCE-STEVENSON

1/1

112 30 045055 mm
10 mm
Fig. 1

1/1

112 30 046055 mm
16 mm
Fig. 2

1/1

112 30 047055 mm
18 mm
Fig. 3



FISCHER
112 91 0099
22,5 cm



ABRAHAM
112 91 0100
19,0 cm



ABRAHAM
112 91 0101
21,0 cm



CANFIELD
112 91 0102
21,0 cm



BRUENINGS
112 91 0103
23,0 cm



DOUGLAS
112 91 0104
21,0 cm

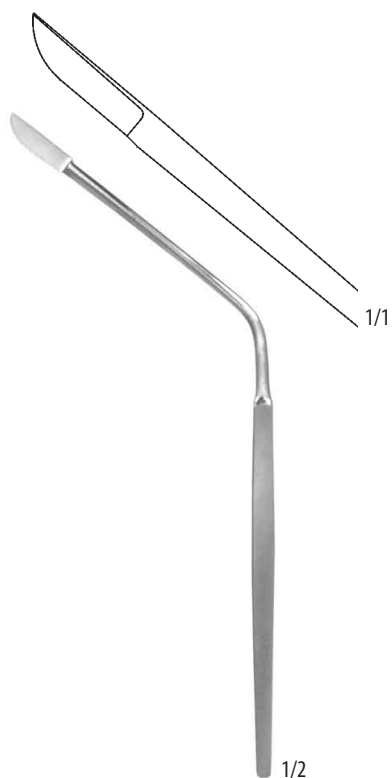

NŮŽ NA FLEGMONU
PHEGMON KNIFE
112 32 0080
17,7 cm

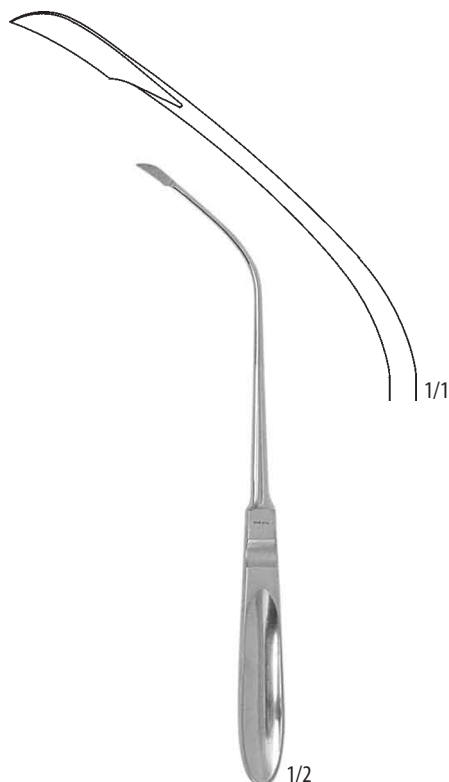

BAGINSKY
NŮŽ HRTANOVÝ
LARYNGEAL KNIFE
112 33 0020
24,5 cm



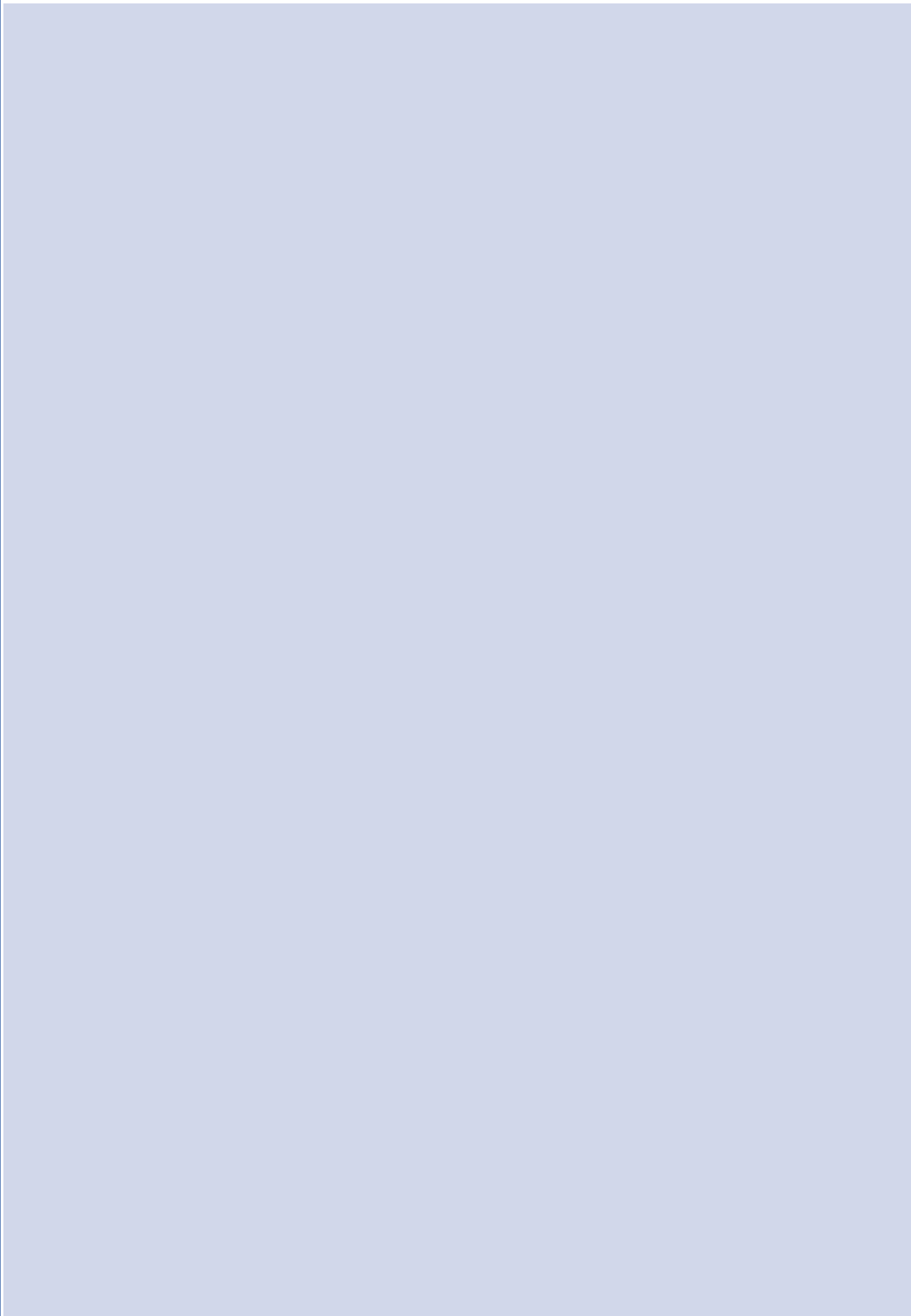

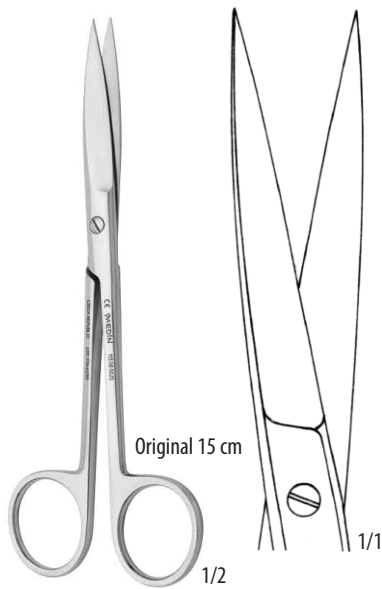

STANDARD

rovné – straight	zahnuté – curved
113 91 0042 – 11,5 cm	– 113 91 0051
113 08 0010 – 13,0 cm	– 113 08 0310
113 08 0020 – 15,0 cm	– 113 08 0320
113 91 0046 – 16,5 cm	– 113 91 0055
113 08 0040 – 18,5 cm	– 113 08 0340
113 91 0049 – 20,0 cm	– 113 91 0058
113 08 0060 – 22,0 cm	– 113 08 0360
113 08 0070 – 30,0 cm	– 113 08 0370

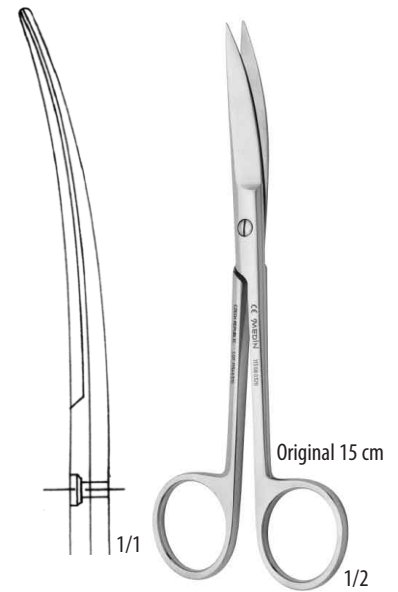

STANDARD

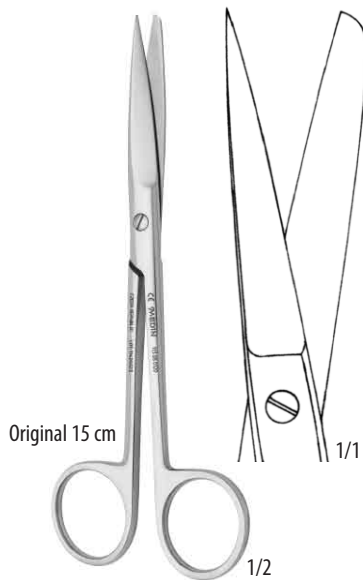

STANDARD

rovné – straight	zahnuté – curved
113 91 0020 – 11,5 cm	– 113 91 0031
113 08 0110 – 13,0 cm	– 113 08 0410
113 08 0120 – 15,0 cm	– 113 08 0420
113 91 0026 – 16,5 cm	– 113 91 0037
113 08 0140 – 18,5 cm	– 113 08 0440
113 91 0029 – 20,0 cm	– 113 91 0040
113 08 0160 – 22,0 cm	– 113 08 0460
113 08 0170 – 30,0 cm	– 113 08 0470

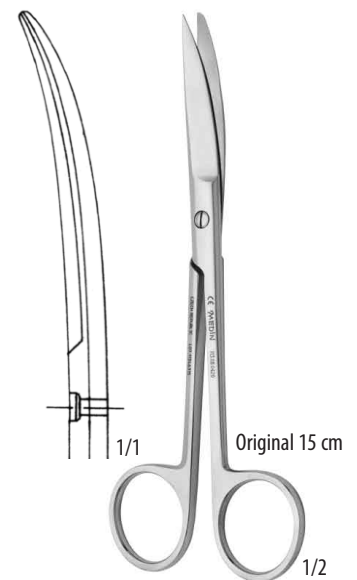

STANDARD

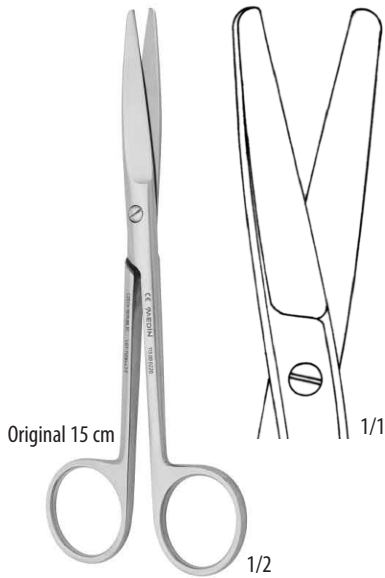

STANDARD

rovné – straight	zahnuté – curved
113 91 0002 – 11,5 cm	– 113 91 0011
113 08 0210 – 13,0 cm	– 113 08 0510
113 08 0220 – 15,0 cm	– 113 08 0520
113 91 0006 – 16,5 cm	– 113 91 0015
113 08 0240 – 18,5 cm	– 113 08 0540
113 91 0009 – 20,0 cm	– 113 91 0018
113 08 0260 – 22,0 cm	– 113 08 0560
113 08 0270 – 30,0 cm	– 113 08 0570

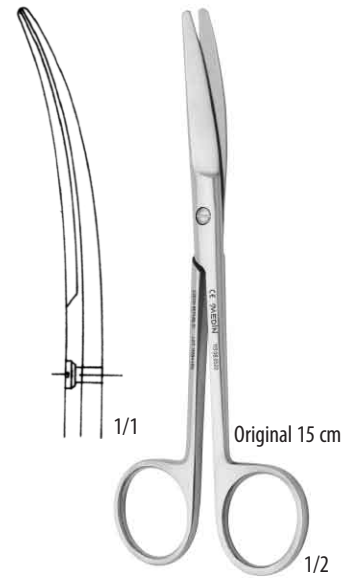

STANDARD

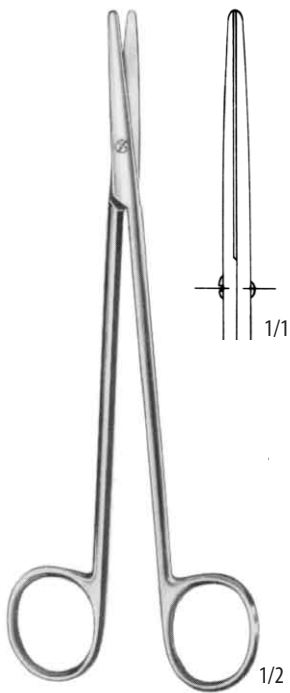

METZENBAUM-NELSON

113 91 0143

rovné – straight

18,0 cm

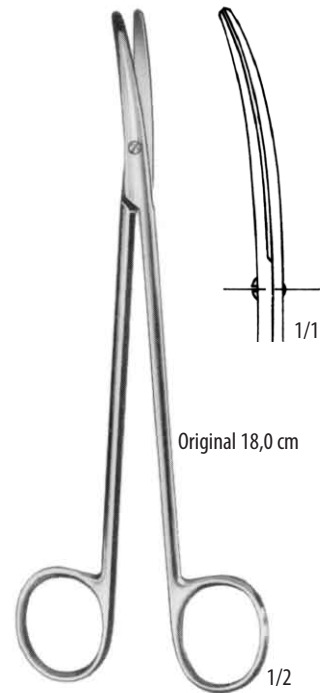

METZENBAUM-NELSON

zahnuté – curved

113 08 0700 – 14,0 cm

113 91 0152 – 18,0 cm

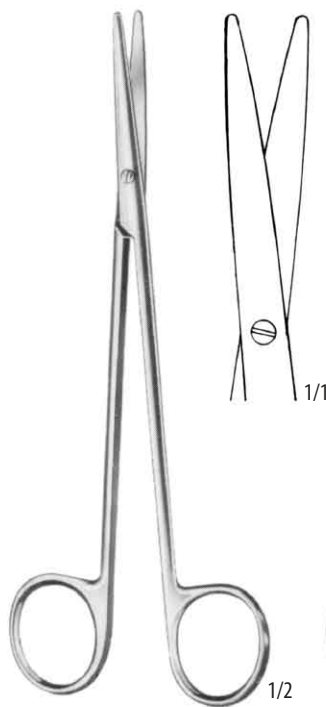

METZENBAUM-DELICATE

rovné – straight

113 91 0189

18,0 cm

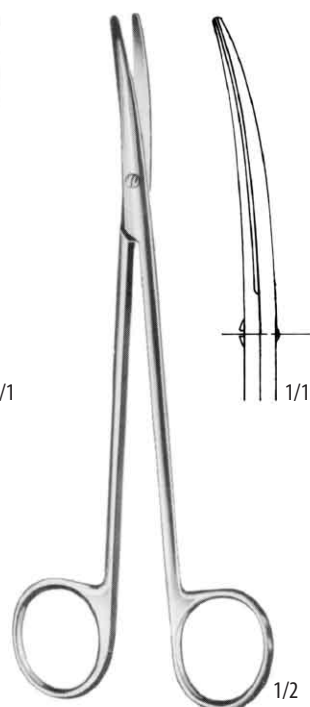

METZENBAUM-DELICATE

zahnuté – curved

113 91 0195

18,0 cm

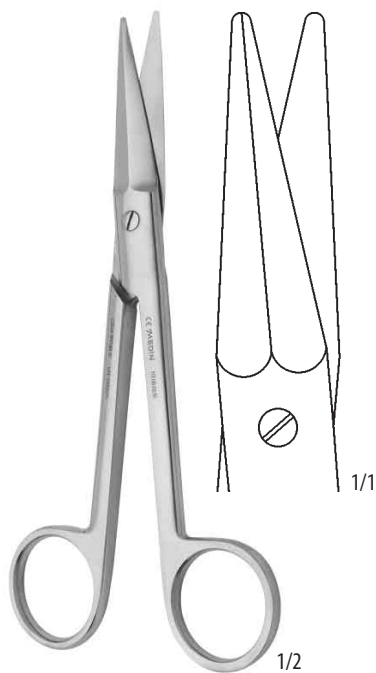

MAYO
113 08 0830
rovné – straight
17,0 cm

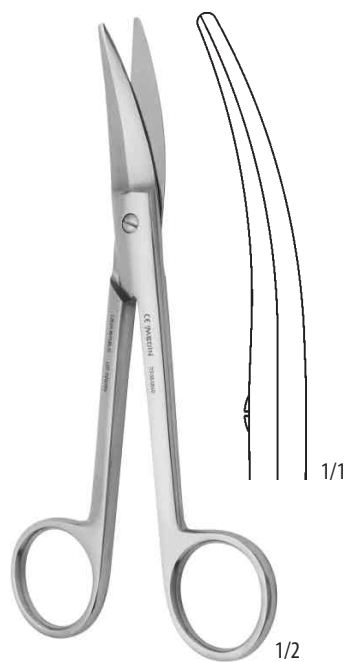

MAYO
113 08 0840
zahnuté – curved
16,8 cm

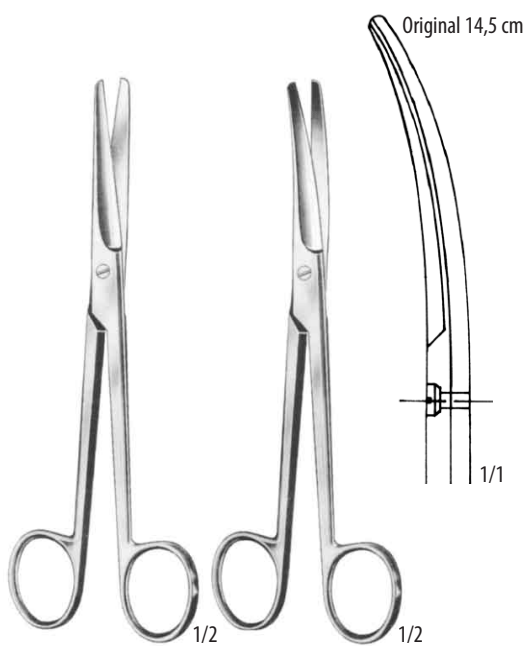

MAYO
rovné – straight zahnuté – curved
113 91 0083 – 14,5 cm – **113 91 0090**
113 91 0087 – 23,0 cm – **113 91 0094**

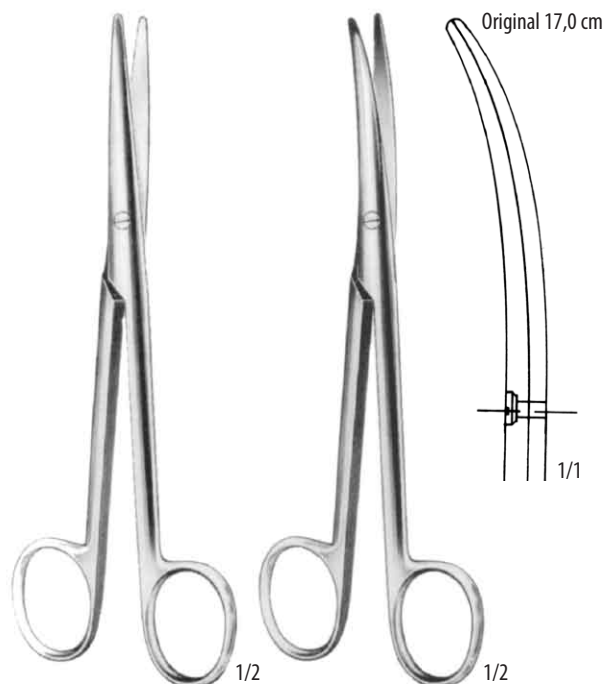

MAYO-STILLE
rovné – straight zahnuté – curved
113 91 0097 – 15,0 cm – **113 91 0101**
113 91 0098 – 17,0 cm – **113 91 0102**

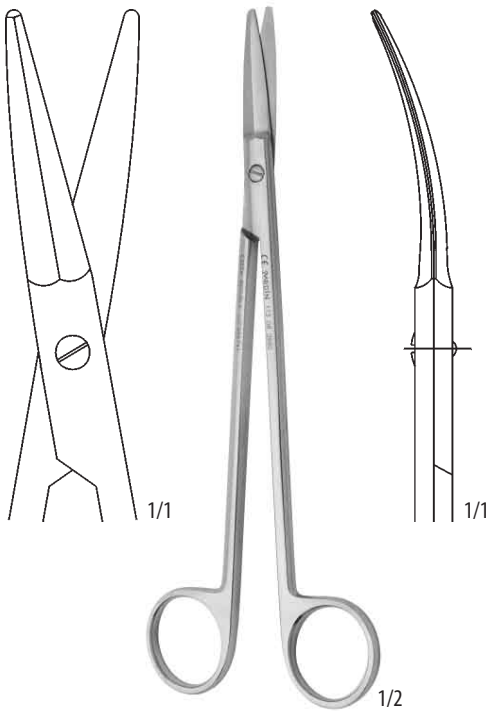

113 08 0880
rovné – straight
18,5 cm

113 08 0890
zahnuté – curved
18,5 cm

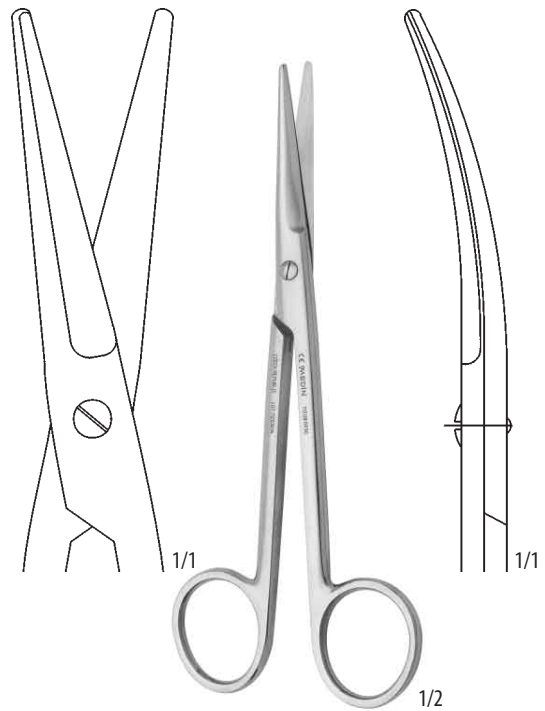

113 08 0930
rovné – straight
17,0 cm

113 08 0940
zahnuté – curved
17,0 cm

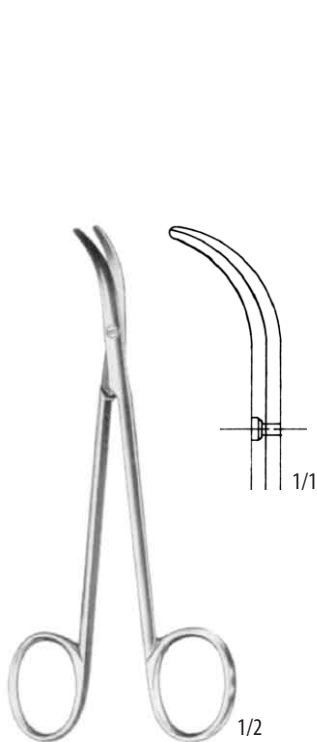

FOMON
113 91 0217
13,5 cm

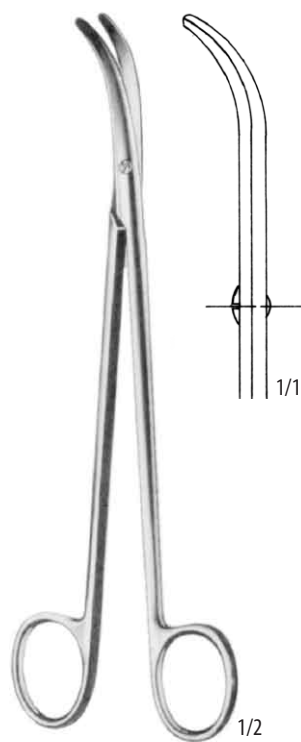

THOREK
113 91 0218
19,0 cm



LEXER-BABY
113 91 0219
rovné – straight
10,0 cm

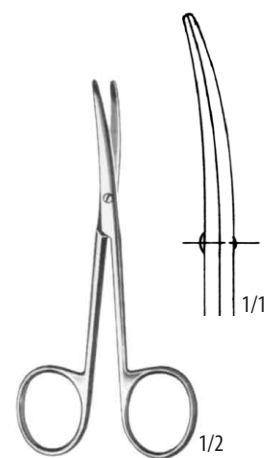

LEXER-BABY
113 91 0220
zahnuté – curved
10,0 cm

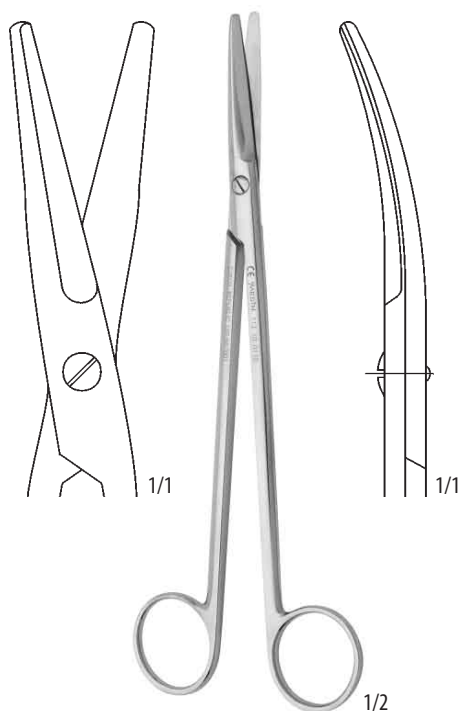

113 10 0110
rovné – straight
18,5 cm

113 10 0120
zahnuté – curved
18,5 cm

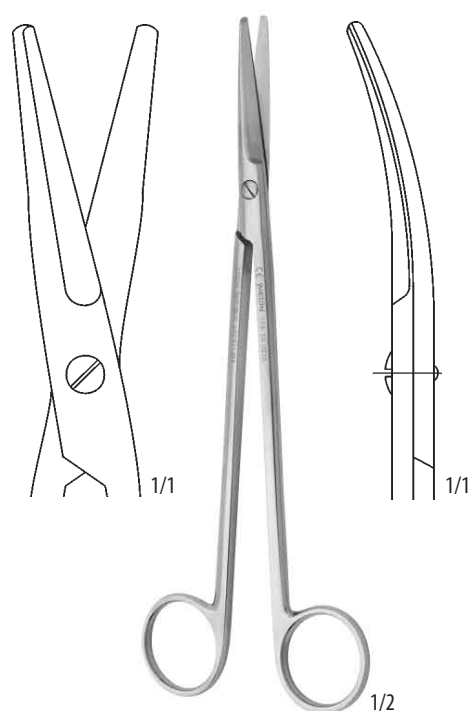

113 10 0210
rovné – straight
18,5 cm

113 10 0220
zahnuté – curved
18,5 cm



LEXER
113 91 0215
16,0 cm

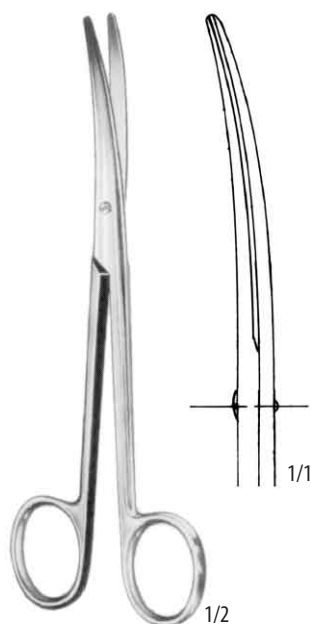

LEXER
113 91 0216
16,0 cm

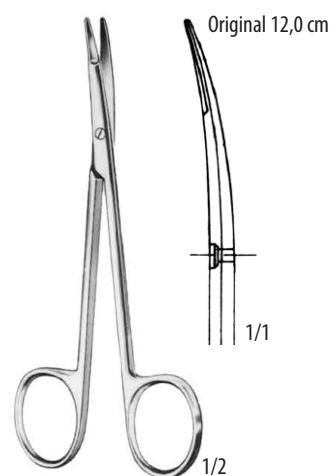

KILNER (RAGNELL)
113 91 0229
12,0 cm
113 91 0230
15,0 cm



SANVENERO
113 91 0221
rovné – straight
14,0 cm

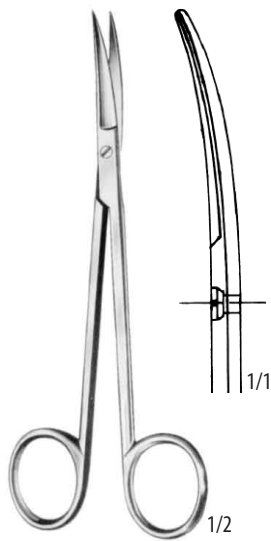

SANVENERO
113 91 0222
zahnuté – curved
14,0 cm



REYNOLDS
113 91 0233
rovné – straight
15,0 cm

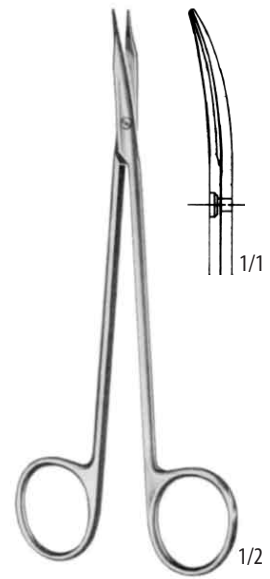

REYNOLDS
113 91 0235
zahnuté – curved
15,0 cm

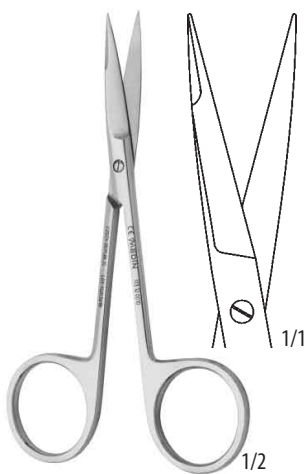
 NŮŽKY PREPARAČNÍ, NOSNÍ
DISSECTING, NASAL SCISSORS

113 12 0010
rovné – straight
12,0 cm

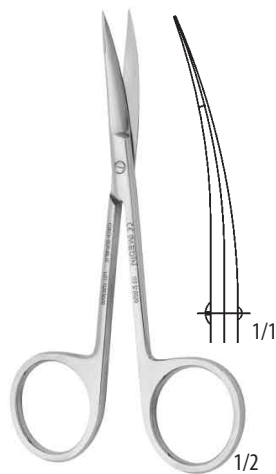

113 12 0020
zahnuté – curved
12,0 cm



HEYMANN
113 30 0010
18,0 cm

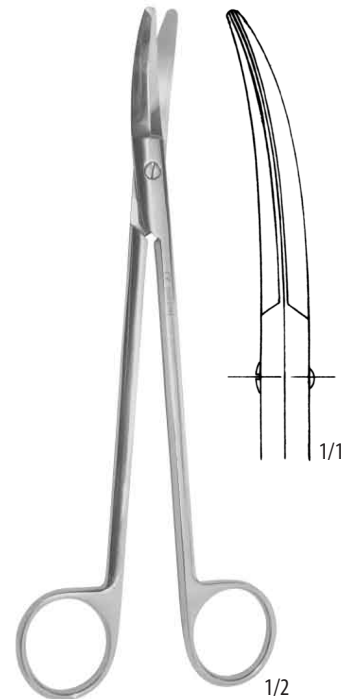

PRINCE
113 32 0010
18,5 cm

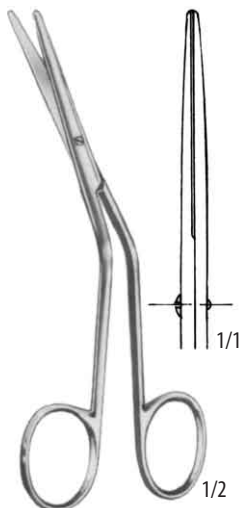

FOMON
113 91 0311
13,5 cm

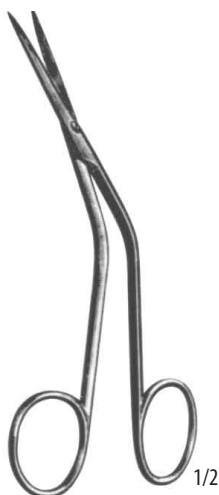

HOUGH
113 91 0684
13,0 cm

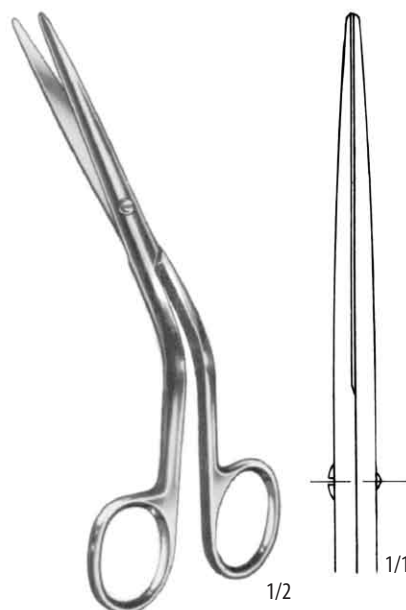

COTTLE
113 91 0313
16,0 cm



STEVENS

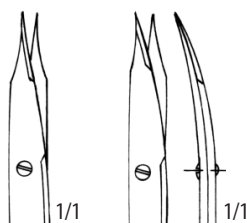

113 91 0379
ostré, rovné
pointed, straight
10,5 cm

113 91 0381
ostré, zahnuté
pointed, curved
10,5 cm

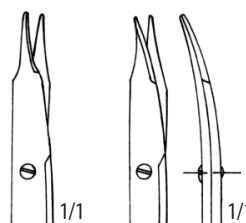

113 91 0383
tupé, rovné
blunt, straight
10,5 cm

113 91 0385
tupé, zahnuté
blunt, curved
10,5 cm

113 91 0380
ostré, rovné
pointed, straight
11,5 cm

113 91 0382
ostré, zahnuté
pointed, curved
11,5 cm

113 91 0384
tupé, rovné
blunt, straight
11,5 cm

113 91 0386
tupé, zahnuté
blunt, curved
11,5 cm

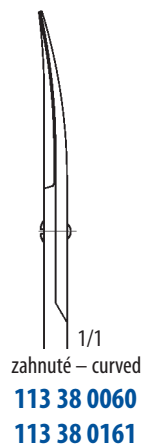
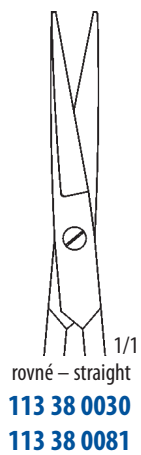
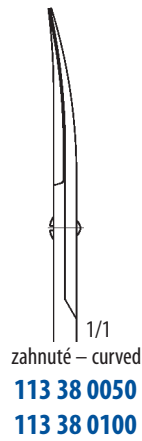
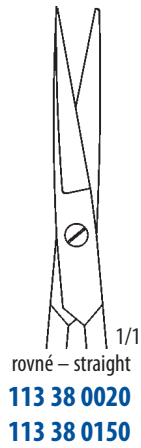
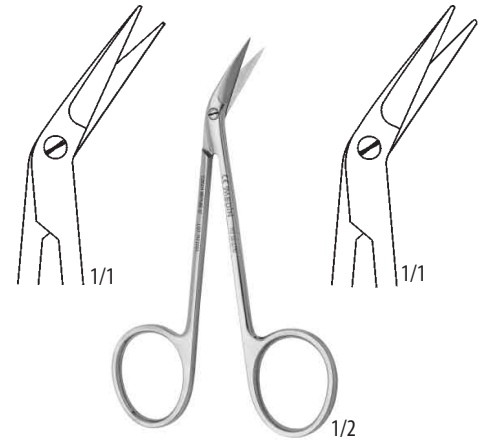
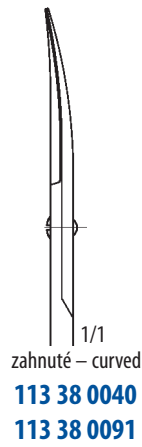
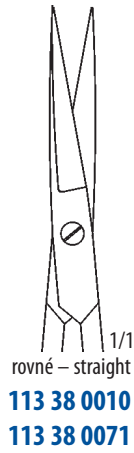

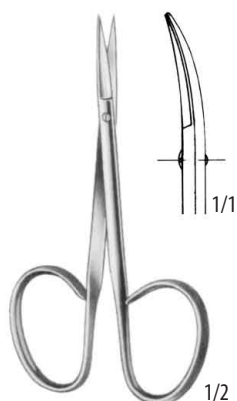
NŮŽKY OČNÍ
EYE SCISSORS

10,0 cm
hrotnaté – sharp

113 91 0387 **113 91 0388**
rovné – straight zahnuté – curved

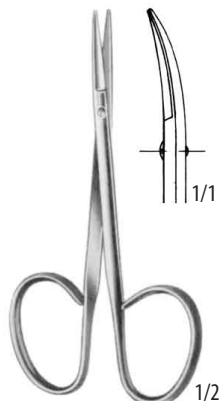

10,0 cm
tupé – blunt

113 91 0389 **113 91 0390**
rovné – straight zahnuté – curved

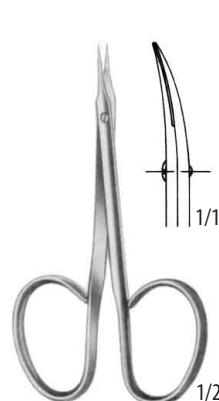

9,5 cm
hrotnaté – sharp

113 91 0393 **113 91 0394**
rovné – straight zahnuté – curved

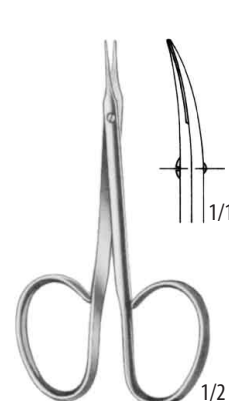

9,5 cm
tupé – blunt

113 91 0395 **113 91 0396**
rovné – straight zahnuté – curved

NŮŽKY PRO LIGATURU
LIGATURE SCISSORS

Original 10,5 cm

SPENCER
113 91 0399 **113 91 0400**
9,0 cm 10,5 cm



LITTAUER
113 91 0403
14,0 cm

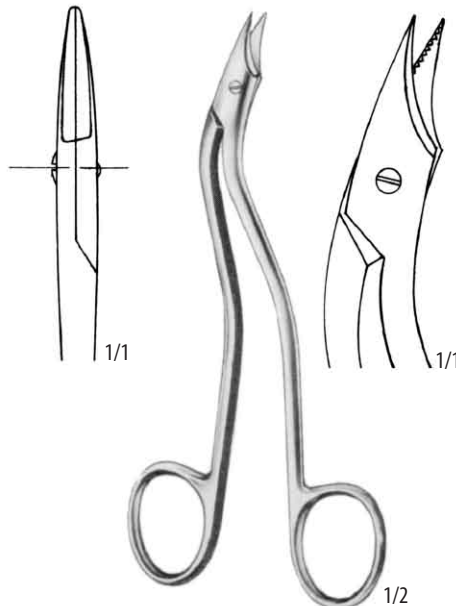

HEATH
113 91 0408
15,0 cm

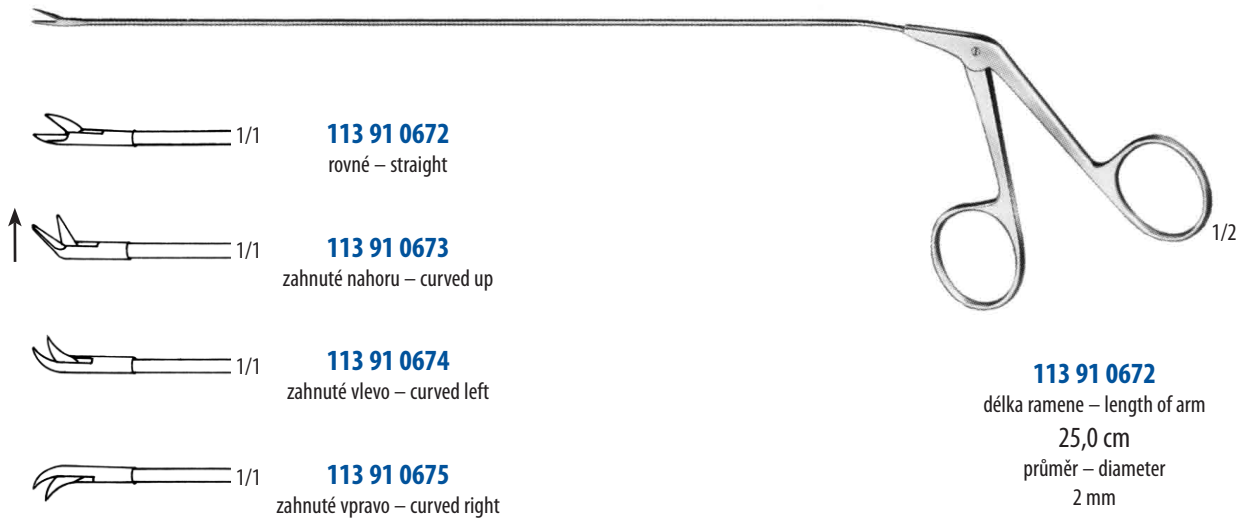

NORTHBENT
113 91 0411
12,5 cm

 NŮŽKY NA SEPTUM
SEPTUM SCISSORS

KILLIAN
113 91 0676
20,0 cm

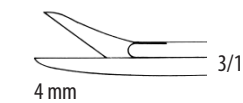

113 91 0677
rovné – straight

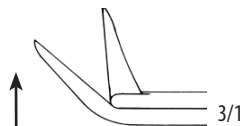

113 91 0678
zahnuté nahoru – curved up



113 91 0679
zahnuté vlevo – curved left



113 91 0680
zahnuté vpravo – curved right



BELLUCCI
délka ramene – length of arm
8,0 cm

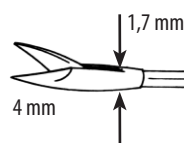

WULLSTEIN
113 91 0681
délka ramene – length of arm
8,0 cm

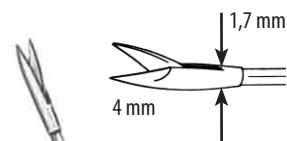

WULLSTEIN
113 91 0682
19,0 cm



IRIS
SUPER CUT
10 cm

113 91 0685

rovné hrotnaté – straight sharp

113 91 0686

zahnuté hrotnaté – curved sharp



JABALEY
SUPER CUT
12 cm

113 91 0687

rovné hrotnaté – straight sharp

113 91 0688

zahnuté hrotnaté – curved sharp



STEVENS
SUPER CUT
12,5 cm

113 91 0689

rovné hrotnaté – straight sharp

113 91 0690

zahnuté hrotnaté – curved sharp



LISTER (BANDAGE)

113 91 0691

14 cm

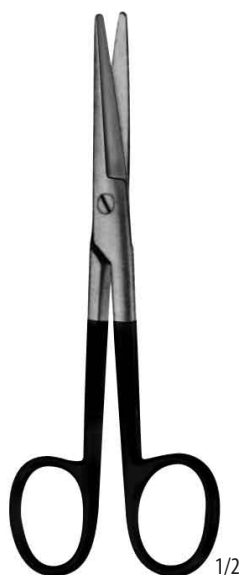

MAYO
SUPER CUT
15 cm

113 91 0692
rovné – straight

113 91 0693
zahnuté – curved

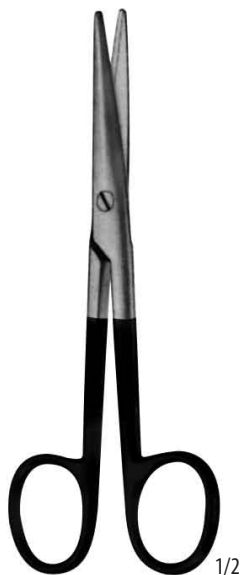

MAYO-STILLE
SUPER CUT

113 91 0694
15 cm
rovné – straight

113 91 0695
17 cm
rovné – straight

113 91 0696
15 cm
zahnuté – curved

113 91 0697
17 cm
zahnuté – curved



MAYO-HARRINGTON
SUPER CUT

113 91 0698
20 cm
rovné – straight

113 91 0699
23 cm
rovné – straight



RANGEL-STILLE
SUPER CUT

113 91 0700
12,5 cm
zahnuté – curved

113 91 0701
15 cm
zahnuté – curved

113 91 0702
18 cm
zahnuté – curved

113 91 0703
20 cm
zahnuté – curved

113 91 0704
23 cm
zahnuté – curved



METZENBAUM
SUPER CUT

113 91 0705

15 cm
rovné – straight

113 91 0706

18 cm
rovné – straight

113 91 0707

20 cm
rovné – straight

113 91 0708

23 cm
rovné – straight

113 91 0709

26 cm
rovné – straight



METZENBAUM
SUPER CUT

113 91 0710

15 cm
zahnuté – curved

113 91 0711

18 cm
zahnuté – curved

113 91 0712

20 cm
zahnuté – curved

113 91 0713

23 cm
zahnuté – curved

113 91 0714

26 cm
zahnuté – curved



BABY METZENBAUM
SUPER CUT

113 91 0715

12,5 cm
rovné – straight

113 91 0716

12,5 cm
zahnuté – curved

**IRIS**

bez tvrdokovu – without TC
11,5 cm

113 91 0717
rovné – straight

113 91 0718
zahnuté – curved

**IRIS**

s tvrdokovem – with TC
11,5 cm

113 91 0719
rovné – straight

113 91 0720
zahnuté – curved

**LA GRANGE**

bez tvrdokovu – without TC
11,5 cm

113 91 0721

**LA GRANGE**

s tvrdokovem – with TC
11,5 cm

113 91 0722

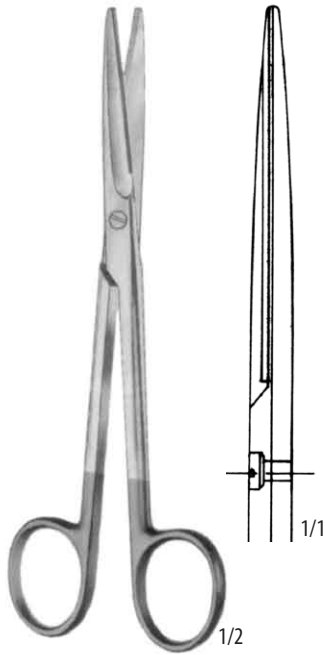
MAYO

113 91 0601
113 91 0602
113 91 0603



Original 17,0 cm

14,5 cm
 17,0 cm
 23,0 cm



113 91 0604
113 91 0605
113 91 0606

MAYO

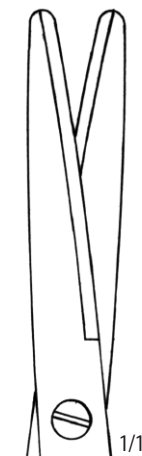
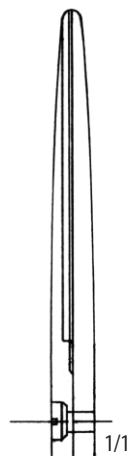
MAYO-STILLE

Original 17,0 cm

113 91 0609
113 91 0610

15,0 cm
 17,0 cm



113 91 0611
113 91 0612

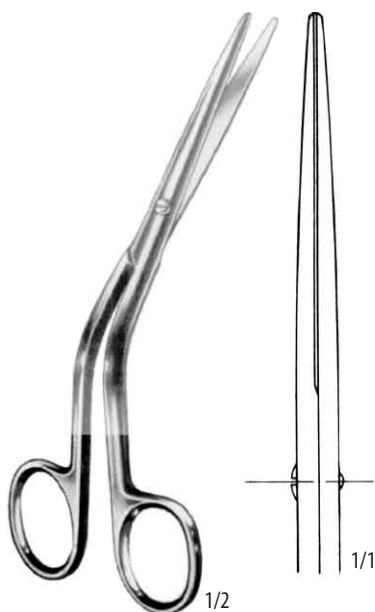

MAYO-STILLE

NŮŽKY TVRDOKOVOVÉ
SCISSORS WITH TUNGSTEN CARBIDE INSERT

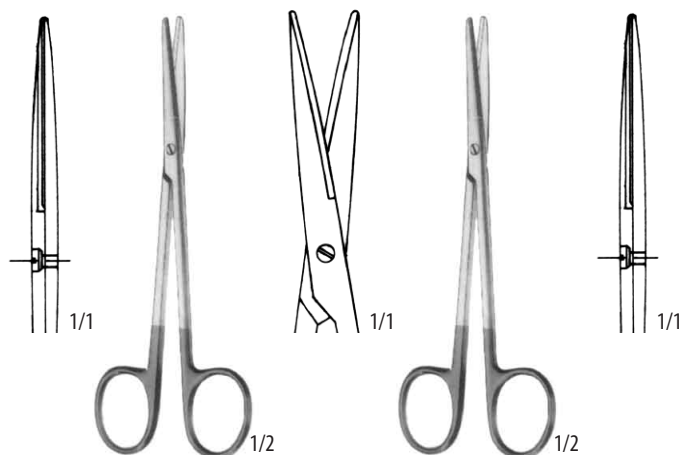
COTTLE
113 91 0683
 16,0 cm

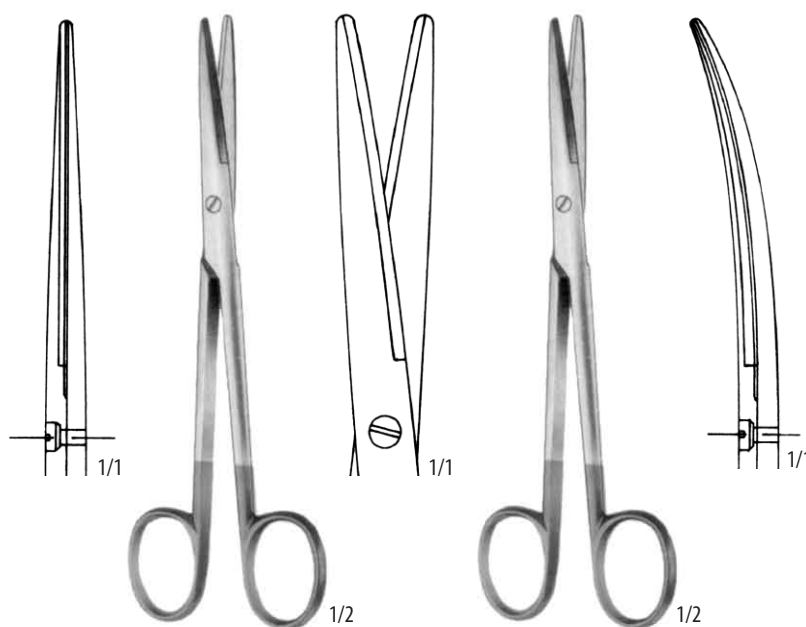

METZENBAUM
 rovné – straight zahnuté – curved
113 91 0617 – 11,5 cm – **113 91 0618**



LEXER
 rovné – straight zahnuté – curved
113 91 0639 – 16,0 cm – **113 91 0640**

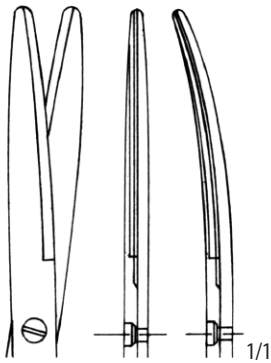

Original 18,0 cm

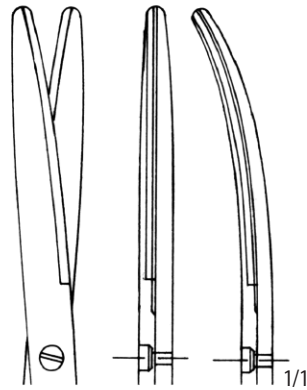

Original 20,0 cm

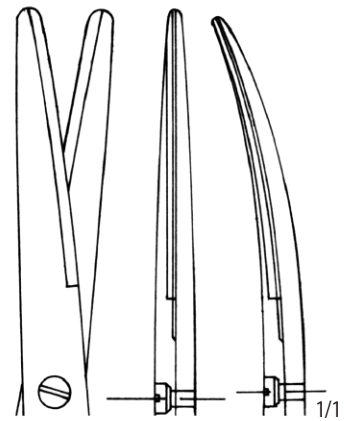

Original 23,0 cm



Original 18,0 cm



Original 18,0 cm

METZENBAUM

rovne – straight

- 113 91 0621
- 113 91 0622
- 113 91 0623
- 113 91 0624
- 113 91 0625

- 18,0 cm –
- 20,0 cm –
- 23,0 cm –
- 25,0 cm –
- 28,0 cm –

zahnute – curved

- 113 91 0627
- 113 91 0628
- 113 91 0629
- 113 91 0630
- 113 91 0631

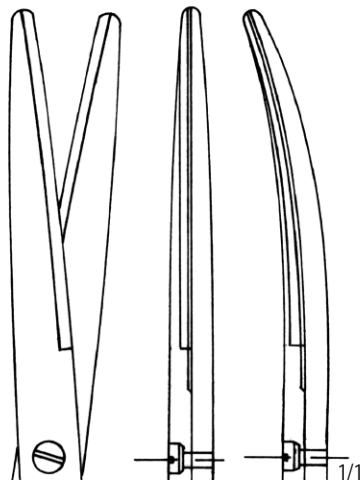

Original 25,0 cm

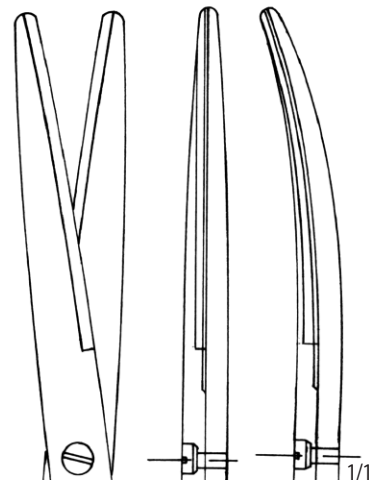

Original 28,0 cm

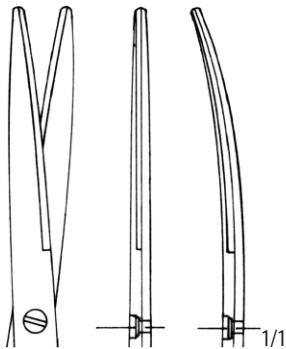

Original 18,0 cm

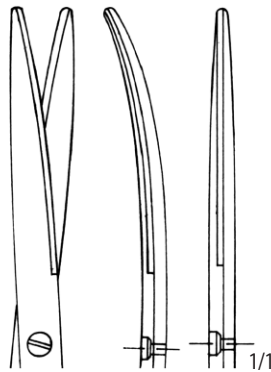

Original 20,0 cm

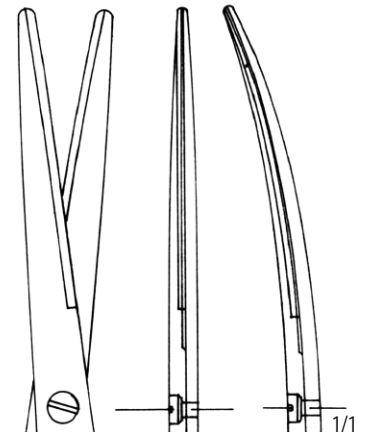

Original 23,0 cm



Original 18,0 cm

1/2



Original 18,0 cm

1/2

METZENBAUM-DELICATE

rovné – straight

- 113 91 0645** – 18,0 cm –
- 113 91 0646** – 20,0 cm –
- 113 91 0647** – 23,0 cm –
- 113 91 0648** – 25,0 cm –
- 113 91 0649** – 28,0 cm –

zahnuté – curved

- 113 91 0650**
- 113 91 0651**
- 113 91 0652**
- 113 91 0653**
- 113 91 0654**

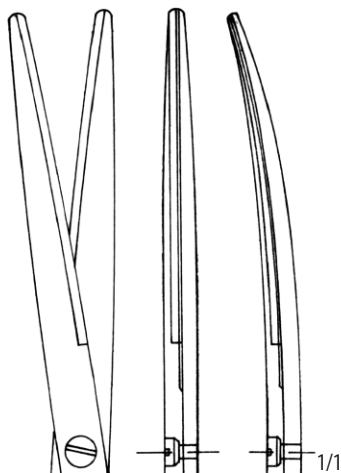

Original 25,0 cm

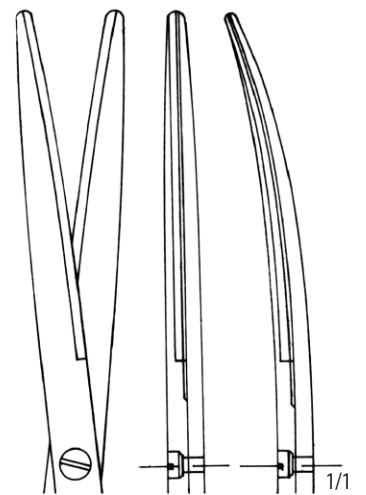

Original 28,0 cm

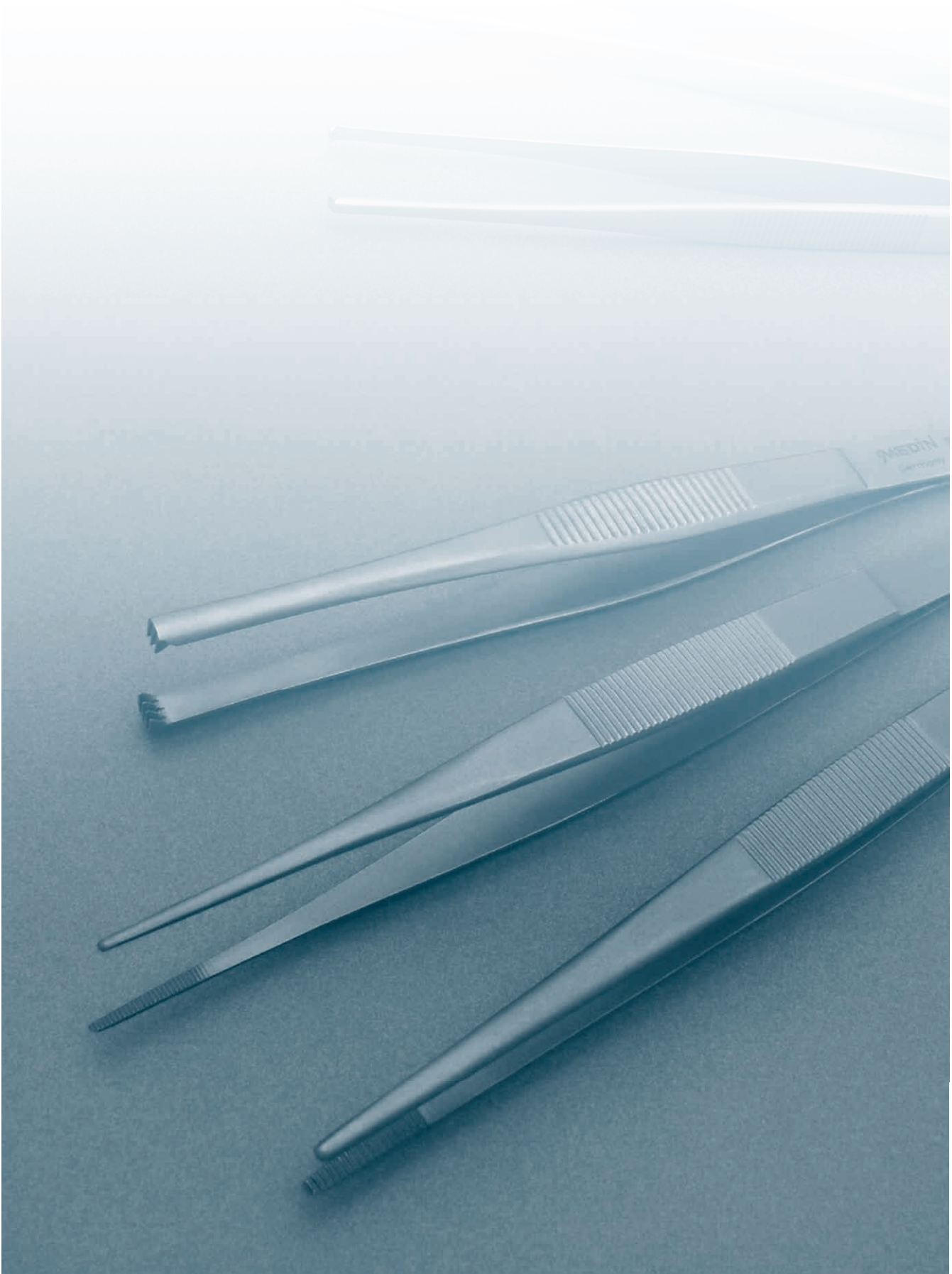



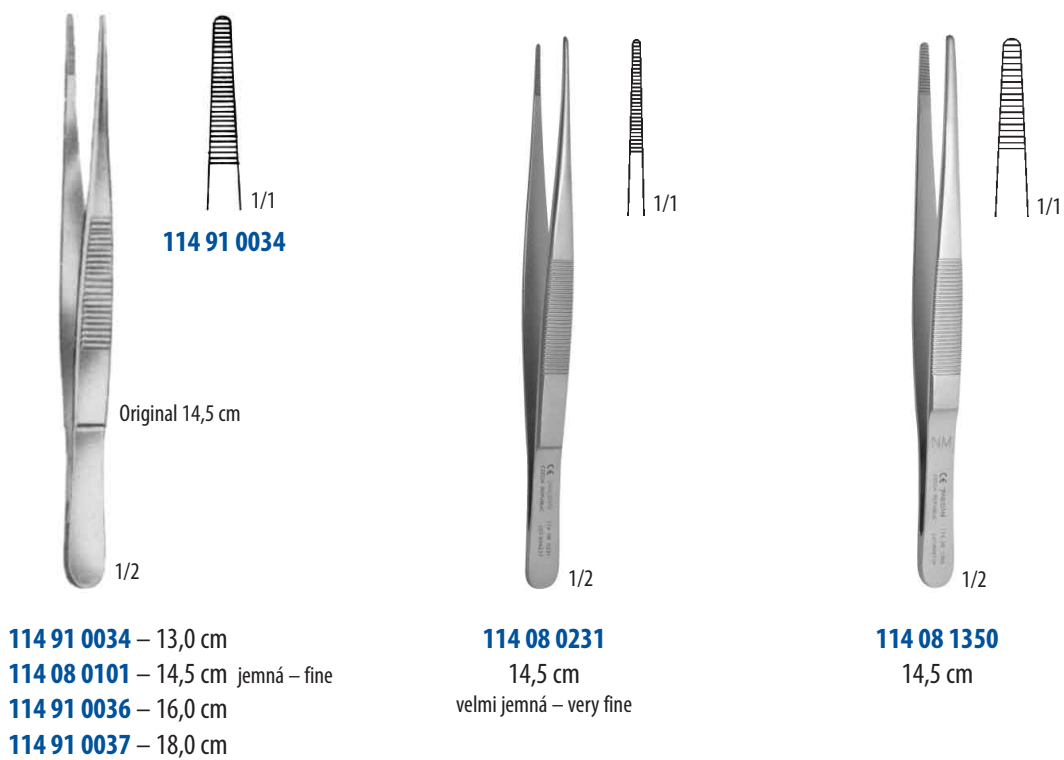
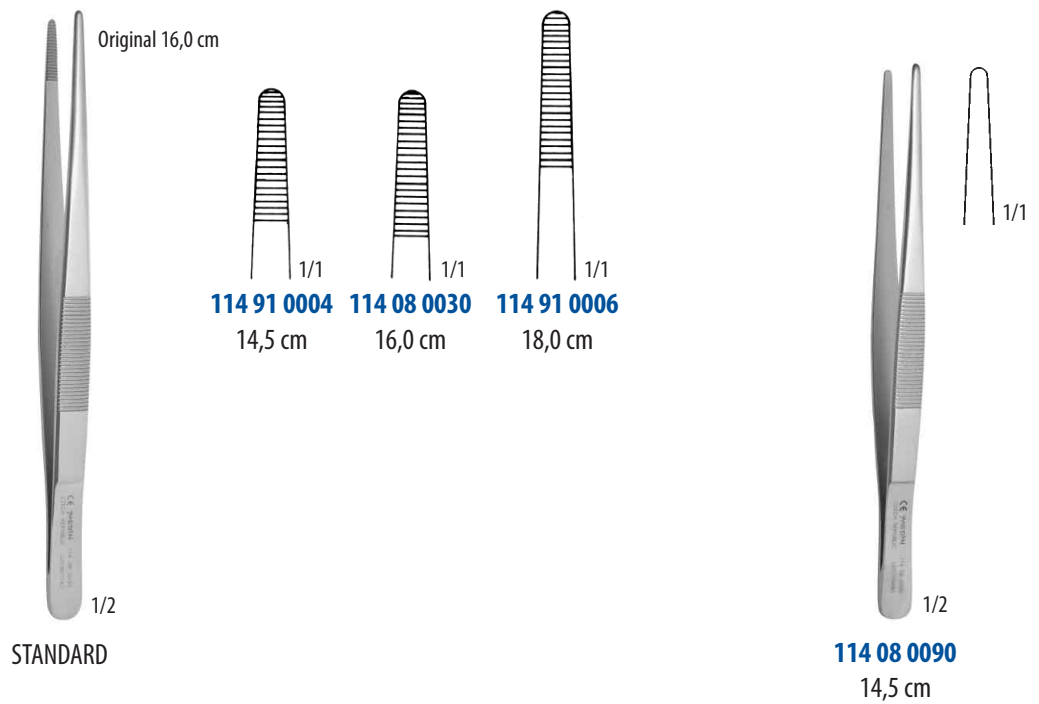

1/1
 (1 × 2)
 1/1
 1/1
 1/1
 1/1
 1/1
114 08 0381 14,5 cm
114 08 0430 16,0 cm
114 91 0015 18,0 cm
 Original 14,5 cm
 1/2
STANDARD

1/1
 (2 × 3)
114 91 0020
 Original 16,0 cm
 1/2
114 91 0020 – 14,5 cm
114 91 0021 – 16,0 cm
114 91 0022 – 18,0 cm
114 91 0023 – 20,0 cm
114 91 0024 – 25,0 cm

1/1
 (3 × 4)
114 91 0027
 Original 16,0 cm
 1/2
114 91 0027 – 14,5 cm
114 91 0028 – 16,0 cm

1/1
 (4 × 5)
114 91 0030
 Original 16,0 cm
 1/2
114 91 0030 – 14,5 cm
114 91 0031 – 16,0 cm



114 08 0530
14,5 cm
velmi jemná – very fine

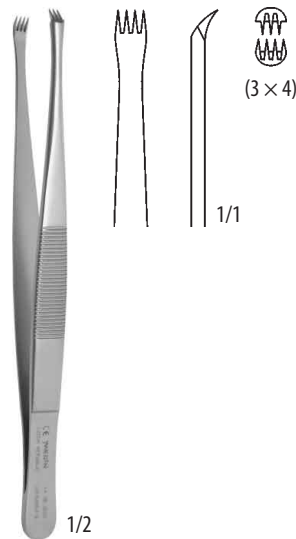

114 08 0620
14,0 cm

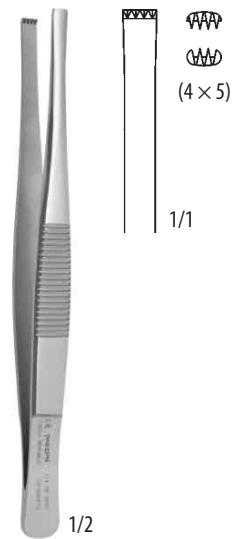

114 08 0660
14,0 cm

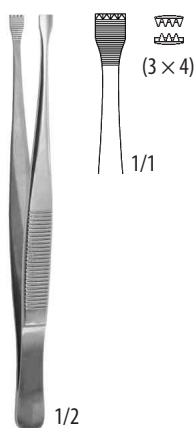

114 12 0030
11,0 cm

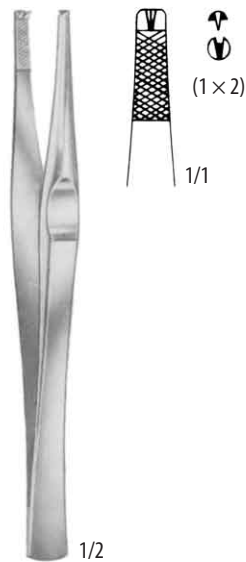

LANE
114 91 0144
14,5 cm

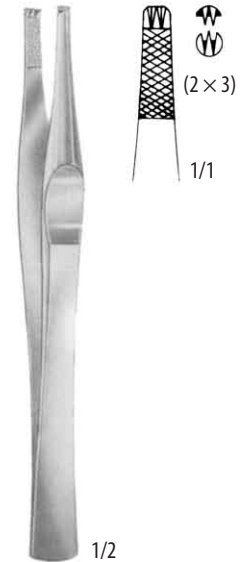

LANE
114 91 0146
14,5 cm

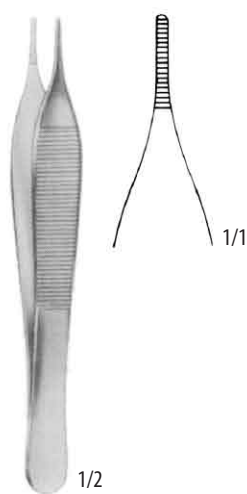
**ADSON**

114 91 0105 – 12,0 cm

114 91 0106 – 15,0 cm

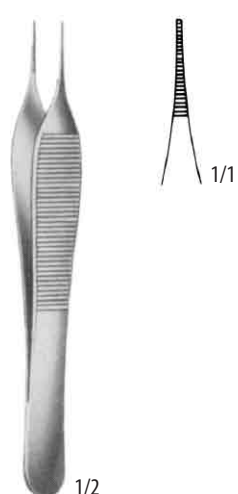
**MICRO-ADSON**

114 91 0108

12,0 cm

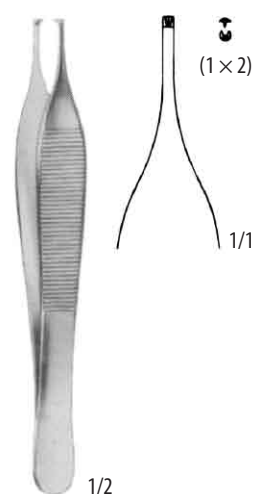
**ADSON**

114 91 0111 – 12,0 cm

114 91 0113 – 15,0 cm

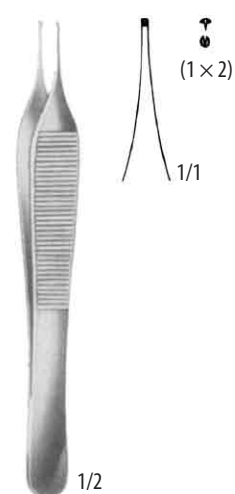
**MICRO-ADSON**

114 91 0114

12,0 cm

**GERALD**

114 91 0148

18,0 cm

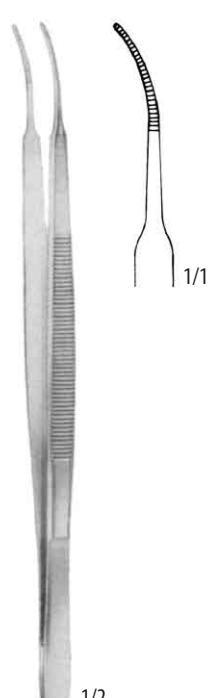
**GERALD**

114 91 0149

18,0 cm

**POTTS-SMITH**

114 91 0156

18,0 cm

**POTTS-SMITH**

114 91 0162

18,0 cm



STILLE-BARRAYA
114 91 0180
 18,0 cm



FERRIS-SMITH
114 91 0183
 18,0 cm

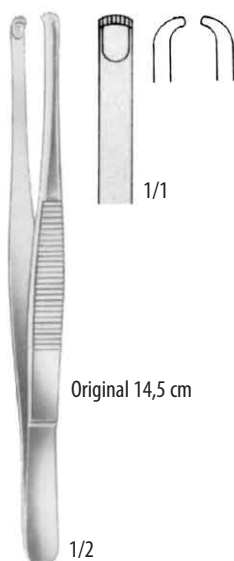

DURANTE
114 91 0211 – 14,5 cm
114 91 0212 – 16,0 cm

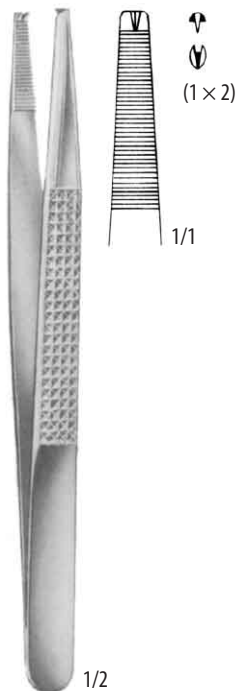

BONNEY
114 91 0215
 18,0 cm

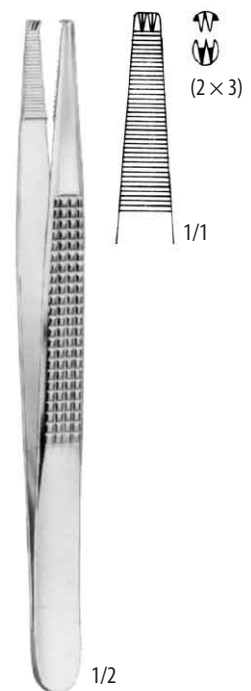

BONNEY
114 91 0216
 18,0 cm

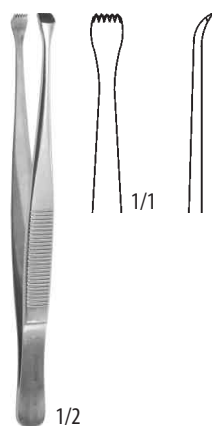

GRAEFE
114 38 0350
11,0 cm

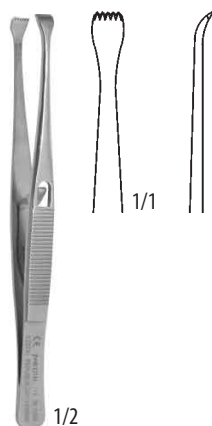

114 38 0360
11,0 cm
se zámkem – with lock

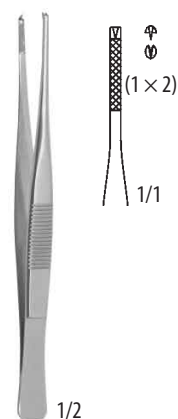

ELSCHMIG
114 38 0370
10,5 cm

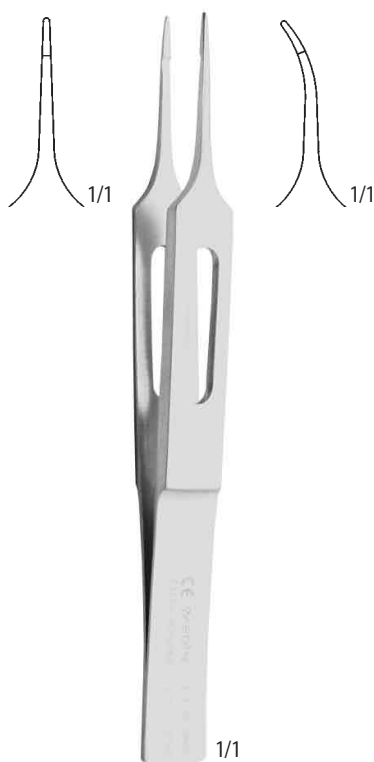

PINZETA NA ROHOVKU
CORNEAL SUTURING FORCEPS
114 38 0860 – 10,0 cm – **114 38 0870**
rovná – straight zahnutá – curved

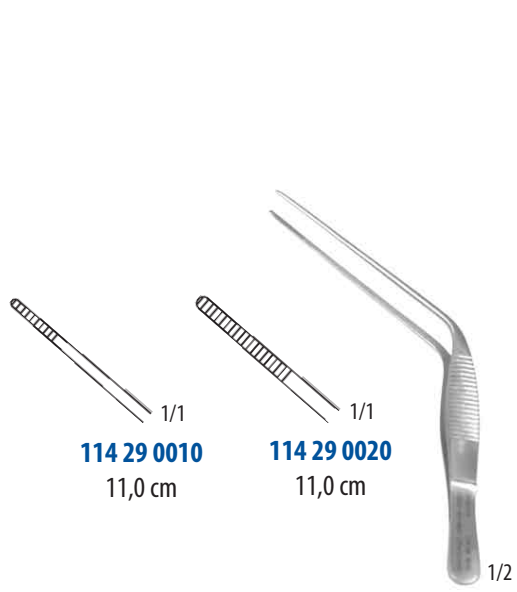
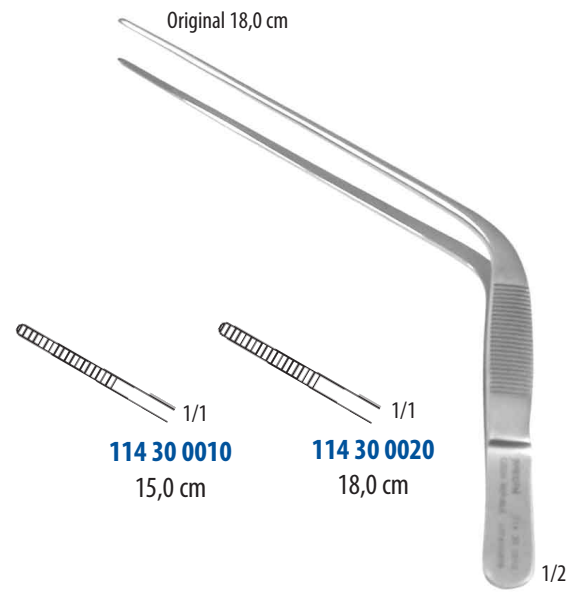
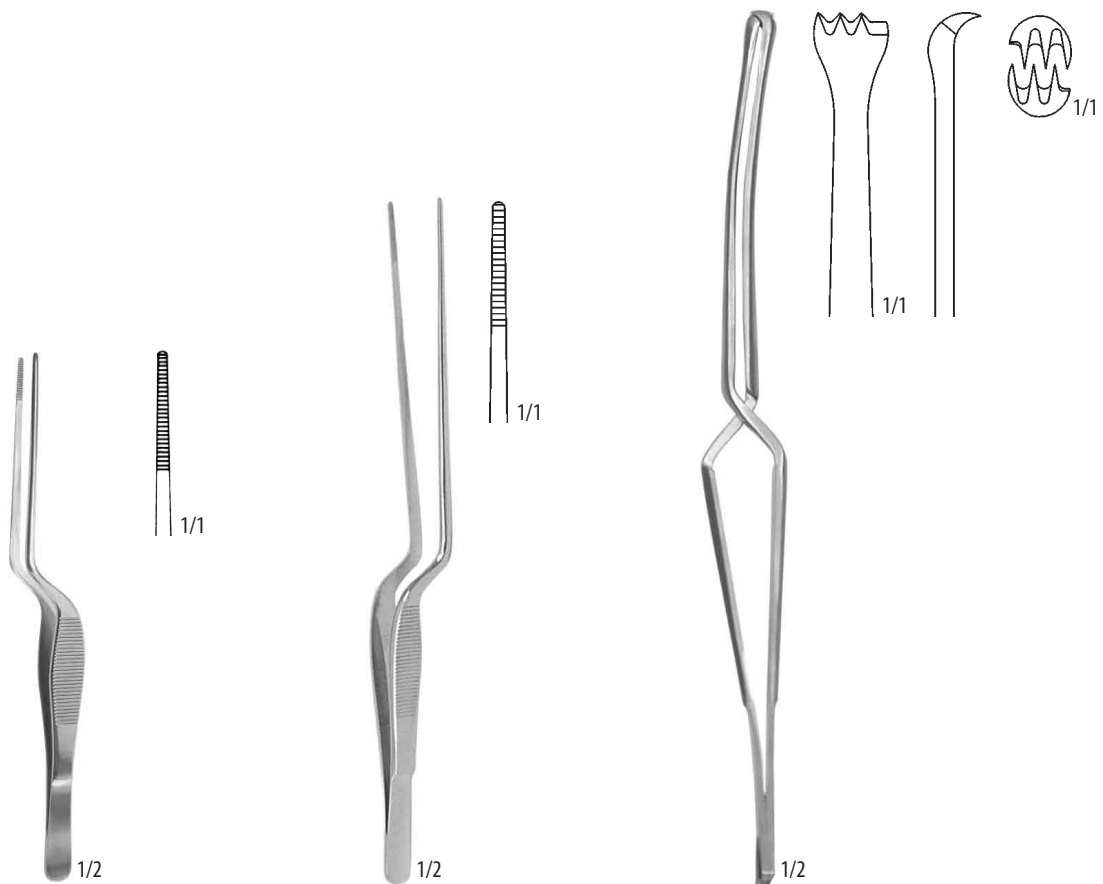
TROELTSCH

TROELTSCH

LUCAE
114 29 0030
 14,0 cm

114 30 0040
 18,0 cm

MARŠÍK
114 32 0010
 22,8 cm

PINZETY BIPOLÁRNÍ
BIPOLAR FORCEPS



1/2

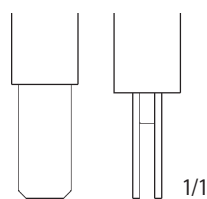
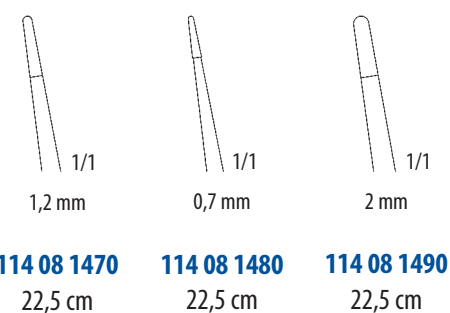

bajonetová – bay-shaped



1/2

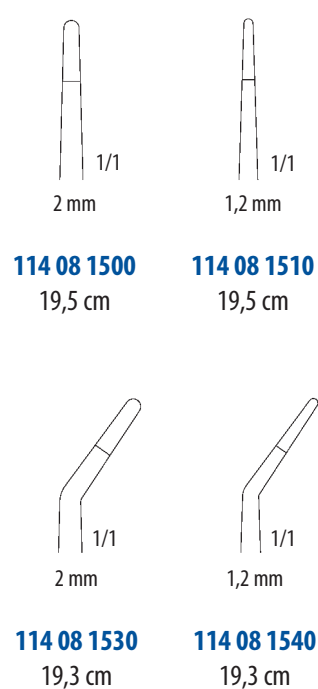

1/2

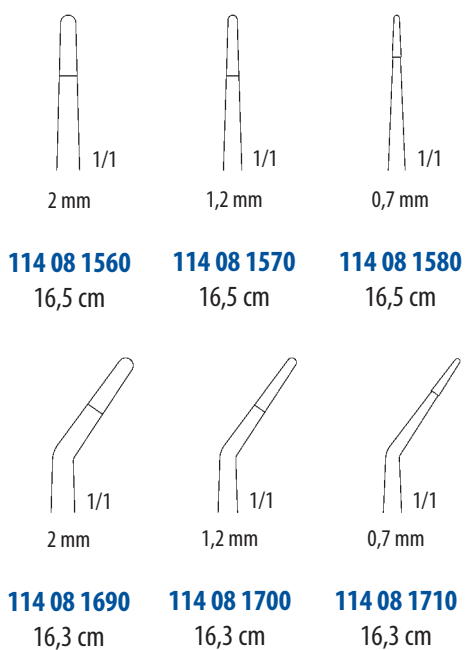

1/2

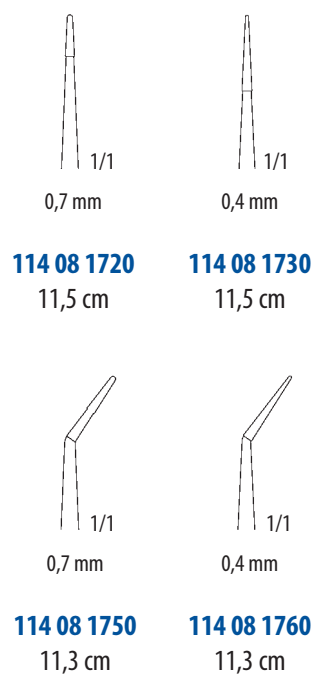

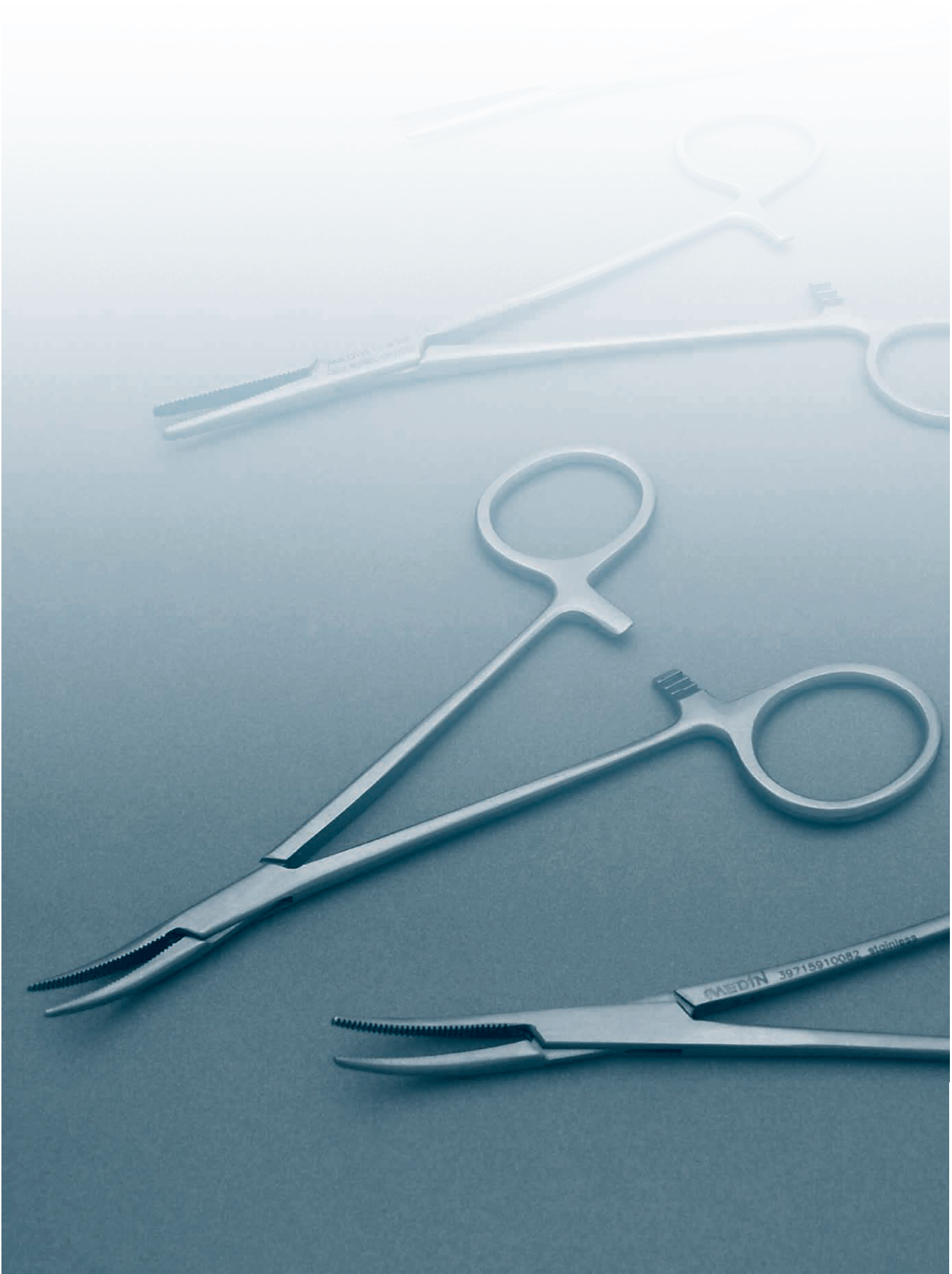



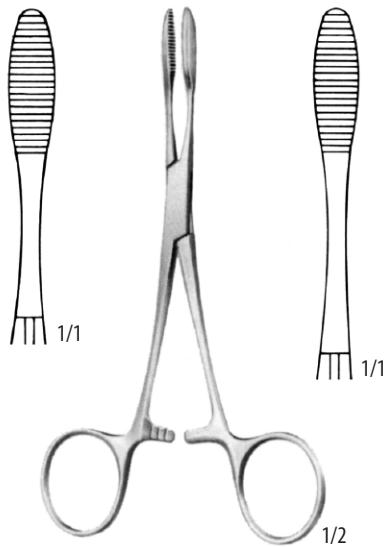

PEAN
115 91 0052
14,0 cm

PEAN
115 91 0053
16,0 cm



BACKHAUS
115 91 0343 – 11,0 cm
115 91 0345 – 15,0 cm



BACKHAUS
115 08 0810 – 8,0 cm
115 08 0820 – 13,0 cm



PEAN
115 08 0071
17,5 cm

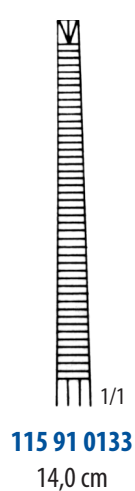

115 91 0133
14,0 cm

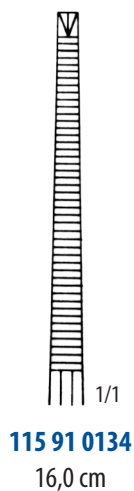

115 91 0134
16,0 cm



OCHSNER-KOCHER

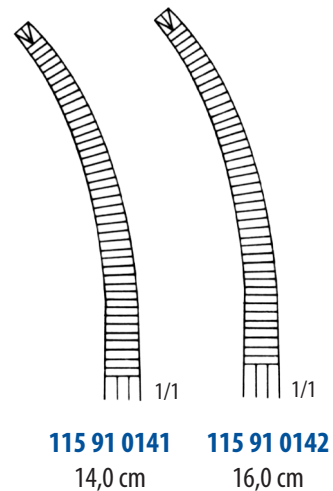

115 91 0141
14,0 cm

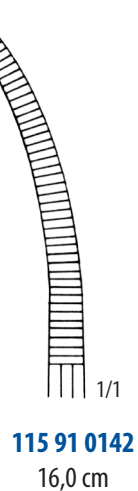

115 91 0142
16,0 cm

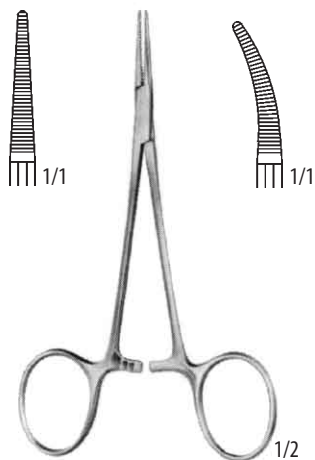
SVORKY NA CÉVY
ARTERY FORCEPS**MOSQUITO-HALSTED**

standard – standard

115 08 0010

12,0 cm

115 08 0020

12,0 cm

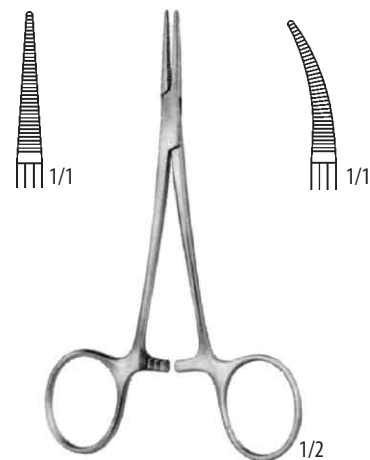
**MOSQUITO-HALSTED**

jemné – fine

115 08 1010

12,0 cm

115 08 1020

12,0 cm

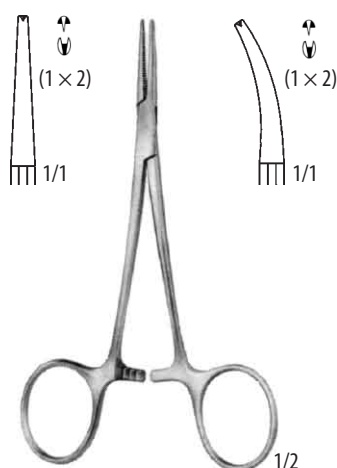
**MOSQUITO-HALSTED**

hladká čelist – smooth jaw

115 08 0040

12,0 cm

115 08 0060

12,0 cm

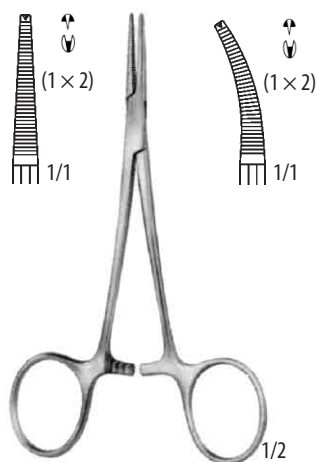
**MOSQUITO-HALSTED**

standard – standard

115 08 0030

12,0 cm

115 08 0050

12,0 cm

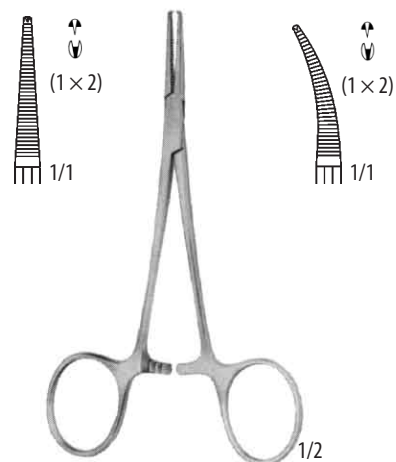
**MOSQUITO-HALSTED**

jemné – fine

115 08 1030

12,0 cm

115 08 1050

12,0 cm

MICRO-MOSQUITO
115 91 0073

12,0 cm

115 91 0075

12,0 cm

MICRO-MOSQUITO
115 91 0077

12,0 cm

115 91 0079

12,0 cm

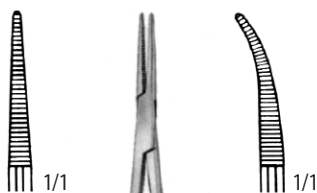
HALSTED-MOSQUITO
115 91 0080

12,0 cm

115 91 0082

12,0 cm

HALSTED-MOSQUITO
115 91 0084

12,0 cm

115 91 0086

12,0 cm



1/2

OVERHOLT-GEISSENDOERFER

21,0 cm

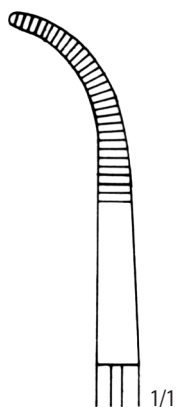

Fig. 1

115 91 0161

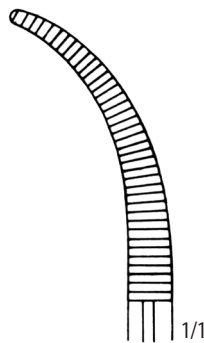

Fig. 2

115 91 0162

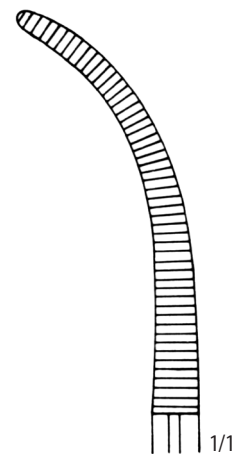

Fig. 3

115 91 0163



1/2

BABY-ADSON
115 91 0180

14,0 cm



1/2

BABY-ADSON
115 91 0181

18,0 cm



MEEKER
115 91 0186
 18,0 cm



SCHNIDT-SAWTELL
115 91 0193
 19,0 cm

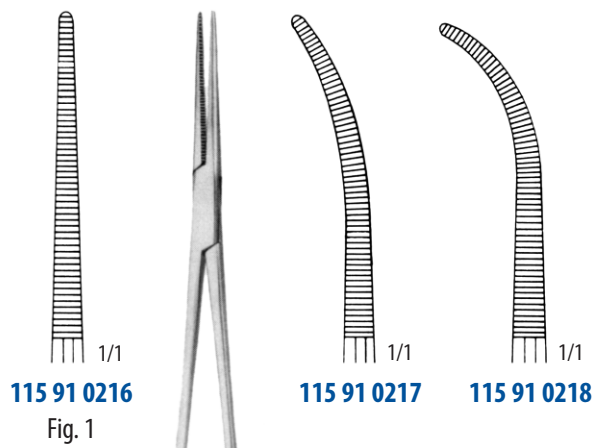

115 91 0216
 Fig. 1

115 91 0217

115 91 0218

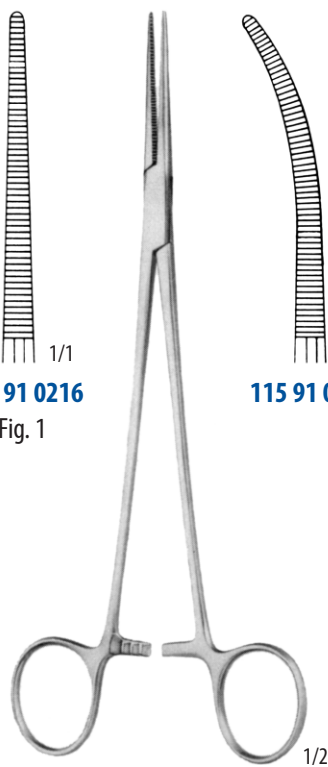

HEISS
 20,0 cm



1/2

ROCHESTER-PEAN**115 08 0231**

16,0 cm



1/1

115 08 0220

14,0 cm

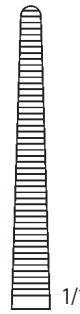

1/1

115 08 0231

16,0 cm

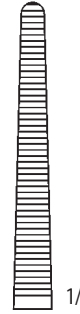

1/1

115 08 0121

20,0 cm



1/2

ROCHESTER-PEAN**115 08 0271**

16,0 cm

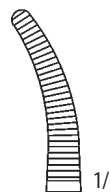

1/1

115 08 0260

14,0 cm

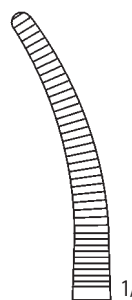

1/1

115 08 0271

16,0 cm

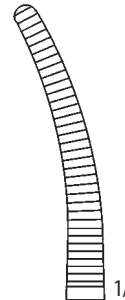

1/1

115 08 0171

20,0 cm

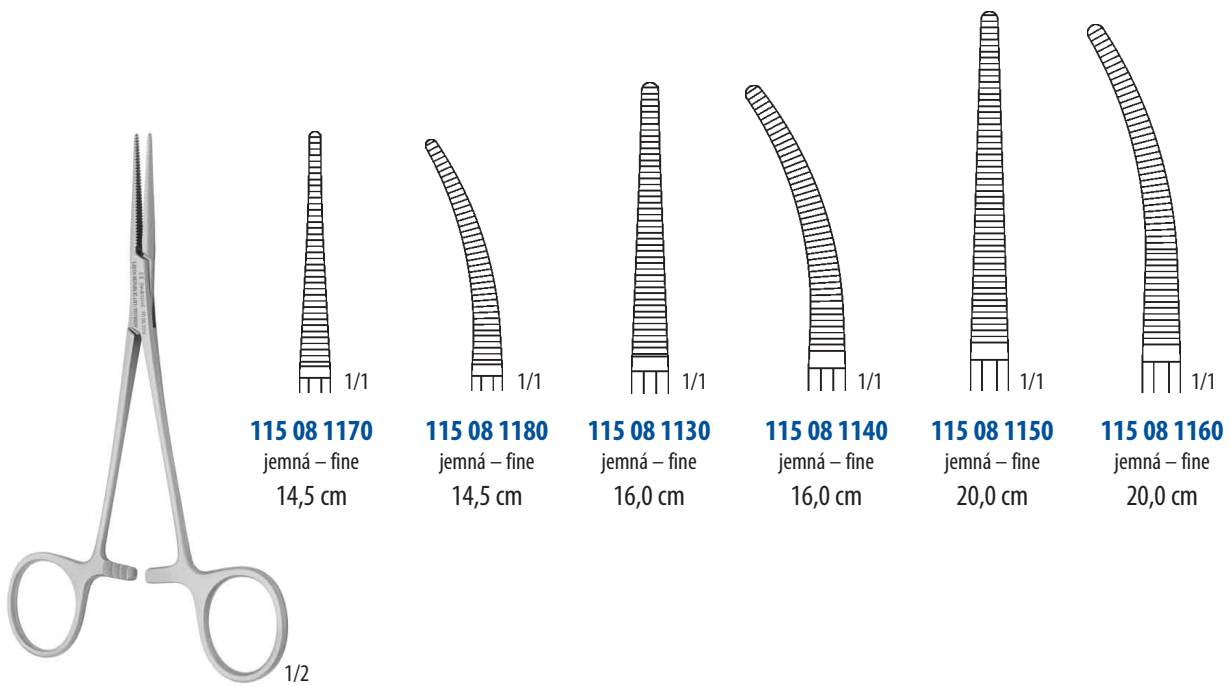

115 08 1170
jemná – fine
14,5 cm

115 08 1180
jemná – fine
14,5 cm

115 08 1130
jemná – fine
16,0 cm

115 08 1140
jemná – fine
16,0 cm

115 08 1150
jemná – fine
20,0 cm

115 08 1160
jemná – fine
20,0 cm

PEAN
115 08 1170
jemná – fine
14,5 cm

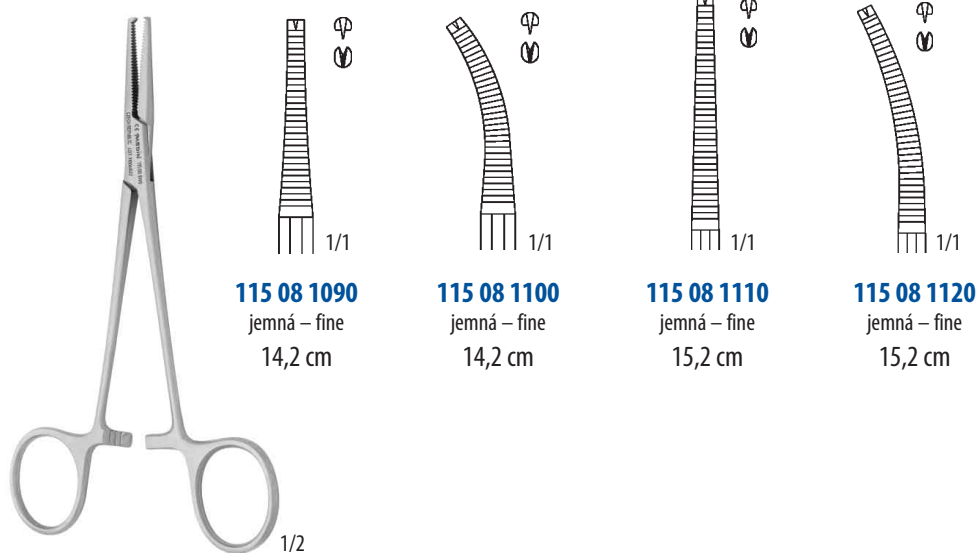

115 08 1090
jemná – fine
14,2 cm

115 08 1100
jemná – fine
14,2 cm

115 08 1110
jemná – fine
15,2 cm

115 08 1120
jemná – fine
15,2 cm

KOCHER
115 08 1090
jemná – fine
14,2 cm

SVORKA NA SVALY
MUSCULAR CLAMP

MASTIN
115 91 0579
17,0 cm

SVORKY NA LOBEKTOMII
LOBECTOMY FORCEPS

OVERHOLT
115 14 1150
19,5 cm







LUER
rovné – straight
116 08 0030
17,0 cm

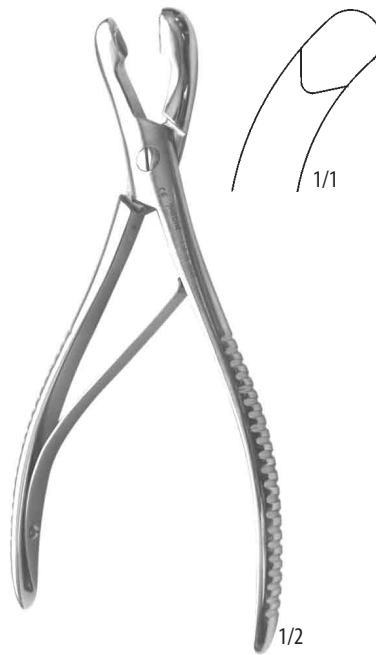

LUER
zahnuté – curved
116 08 0040
17,0 cm

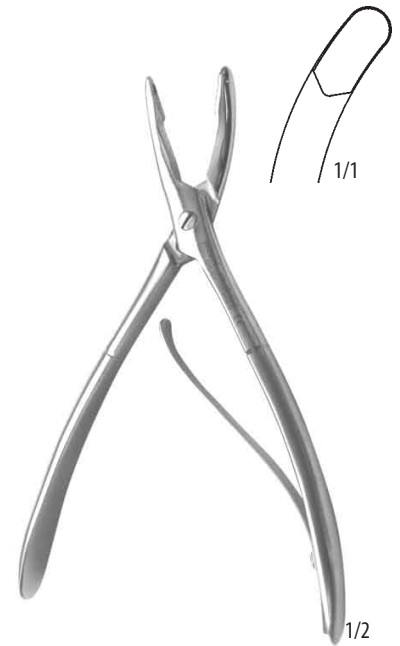

LUER
zahnuté – curved
116 08 0070
15,0 cm



116 91 0527



LUER
zahnuté – curved
116 08 0080
14,5 cm



LUER
15,0 cm

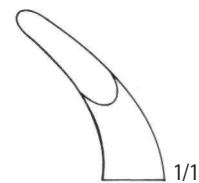

116 91 0528

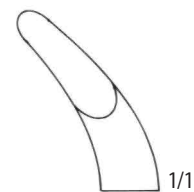

116 91 0529



116 91 0515

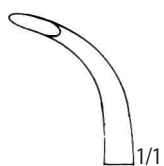

116 91 0516

STELLBRINK
17,0 cm

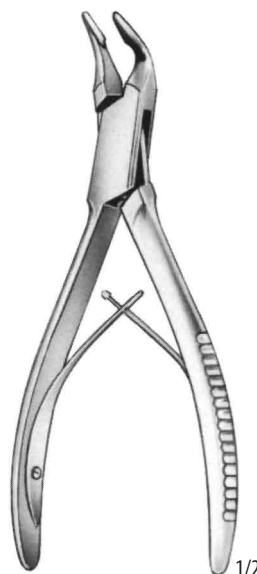

116 91 0522

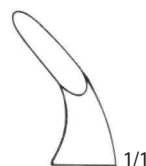

116 91 0523



116 91 0524

BLUMENTHAL
15,5 cm

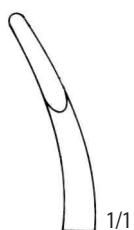
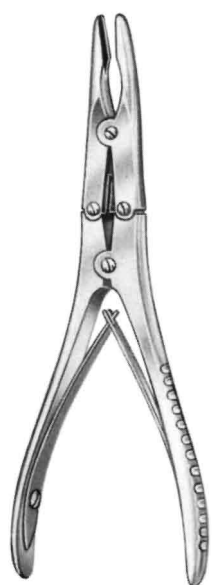

116 91 0263

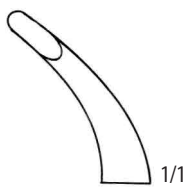

116 91 0264

KEINERT-KUTZ
15,0 cm



116 91 0260



116 91 0261



116 91 0262

BÖHLER
15,0 cm



HARTMANN
116 91 0242 – 2,0 mm
116 91 0243 – 2,5 mm
116 91 0244 – 3,0 mm



HARTMANN
116 91 0245 – 2,0 mm
116 91 0246 – 2,5 mm
116 91 0247 – 3,0 mm



STRÜMPEL
116 91 0248



HARTMANN
116 91 0249



HARTMANN
116 91 0250



HARTMANN-HOFFMANN
116 91 0251

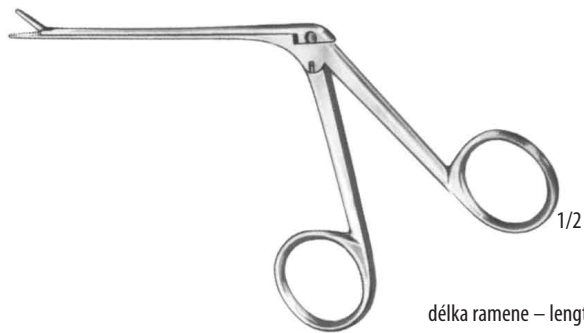

délka ramene – length of arm
8,5 cm

KLEŠTĚ NA UŠNÍ POLYPY
EAR POLYPUS FORCEPS**HARTMANN****116 29 0010**

14,2 cm

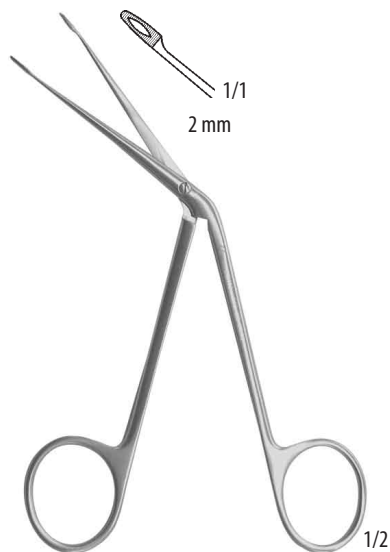
**HARTMANN****116 29 0030**

14,2 cm

**HARTMANN****116 29 0120**

délka ramene – length of arm

10,0 cm

2 × 10,5 mm

**STRÜMPEL****116 29 0300**

délka ramene – length of arm

10,0 cm

2,2 × 7 mm

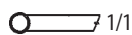
**HARTMANN****116 29 0170**

délka ramene – length of arm

10,0 cm

průměr – diameter

2,6 mm

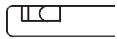

116 29 0740
1,7 × 2 mm



116 29 0750
1,7 × 2 mm

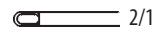

116 29 0760
0,9 × 3,5 mm



116 29 0770
0,9 × 5,5 mm

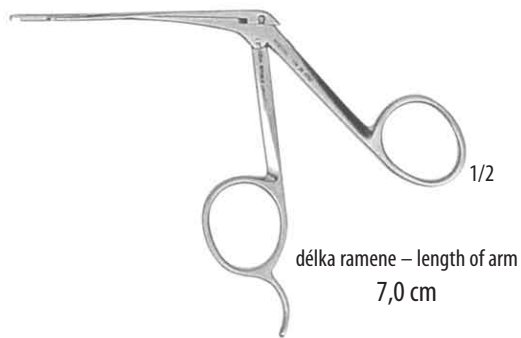

JANSEN
rovné – straight
116 29 0400
18,0 cm
Fig. 1

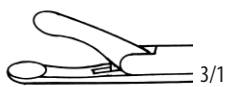

JANSEN
zahnuté – curved
116 29 0410
18,0 cm
Fig. 2

**116 91 0177**

rovné – straight

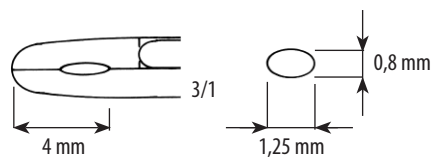
**116 91 0178**

zahnuté vpravo – curved right

**116 91 0179**

zahnuté vlevo – curved left

**116 91 0180**

zahnuté nahoru – curved up

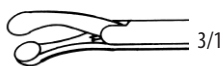
**116 91 0181**

zahnuté dolů – curved down

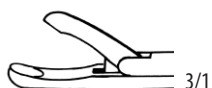
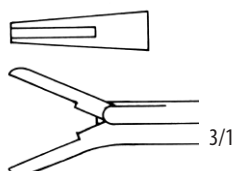
délka ramene – length of arm
8,0 cm**CRURA-NIPPER****116 91 0182**délka ramene – length of arm
8,0 cm**McGEE****116 91 0183**délka ramene – length of arm
8,0 cm

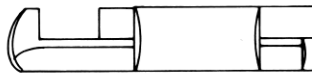

116 91 0184

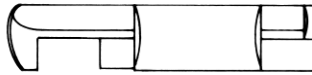

116 91 0185



DIETER

délka ramene – length of arm
8,0 cm

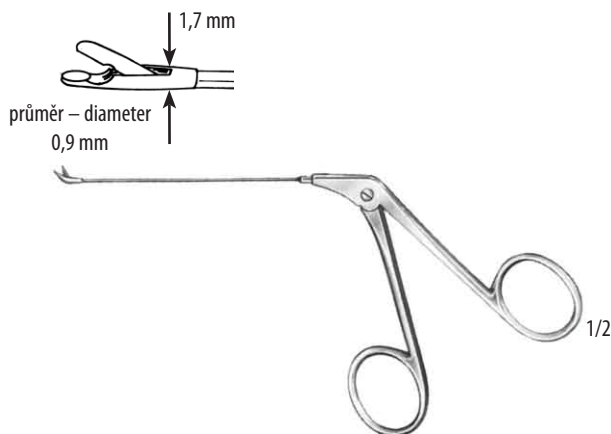

WULLSTEIN
116 91 0186

délka ramene – length of arm
8,0 cm

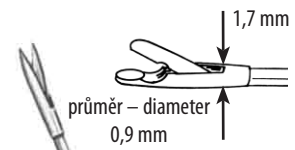

WULLSTEIN
116 91 0187

19,0 cm

MIKRO KLEŠTĚ UŠNÍ
 MICRO EAR FORCEPS

 1/1
116 91 0188

1 mm

 1/1
116 91 0189

2 mm

 1/1
116 91 0190

3 mm

**CITELLI**

délka ramene – length of arm

6,0 cm

**BEYER****116 91 0191**

délka ramene – length of arm

12,0 cm

 E 1/1 **116 91 0192**

 E 1/1 **116 91 0193**

 E 1/1 **116 91 0194**

 E 1/1 **116 91 0195**

 E 1/1 **116 91 0196**

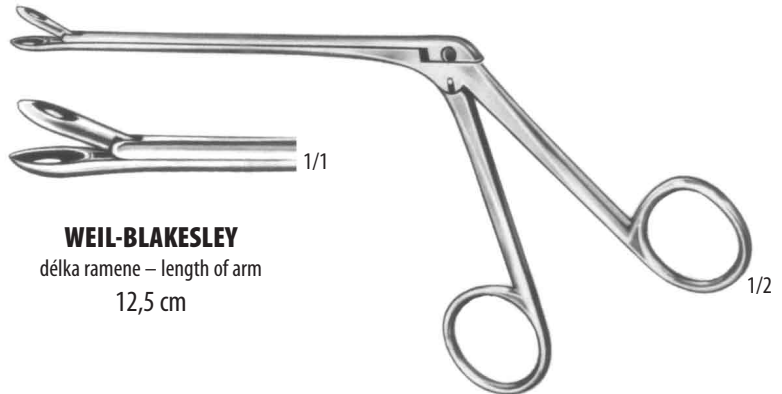

WEIL-BLAKESLEY
délka ramene – length of arm
12,5 cm

 E 1/1 **116 91 0197**

 E 1/1 **116 91 0198**

 E 1/1 **116 91 0199**



WEIL-BLAKESLEY
délka ramene – length of arm
12,5 cm



WEIL-BLAKESLEY
116 91 0200
délka ramene – length of arm
12,5 cm



WEIL-BLAKESLEY
116 91 0201
délka ramene – length of arm
12,5 cm

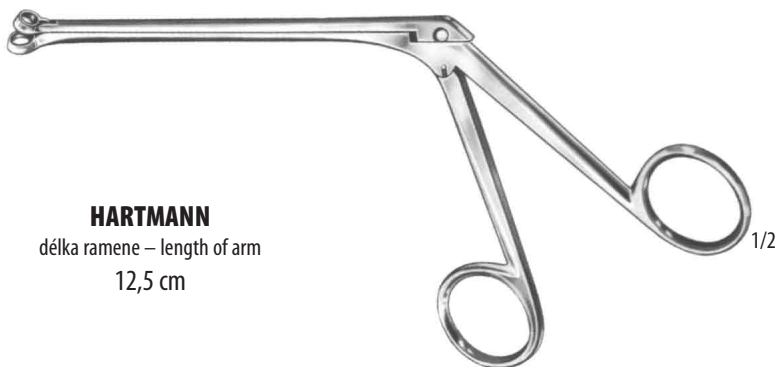
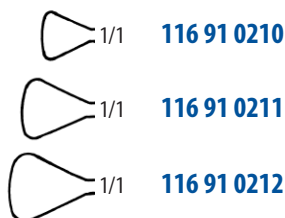
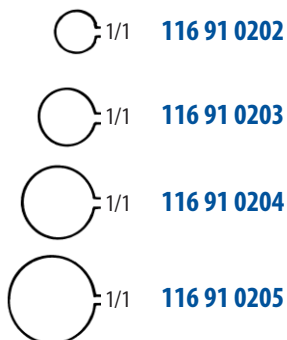



116 91 0219



116 91 0220

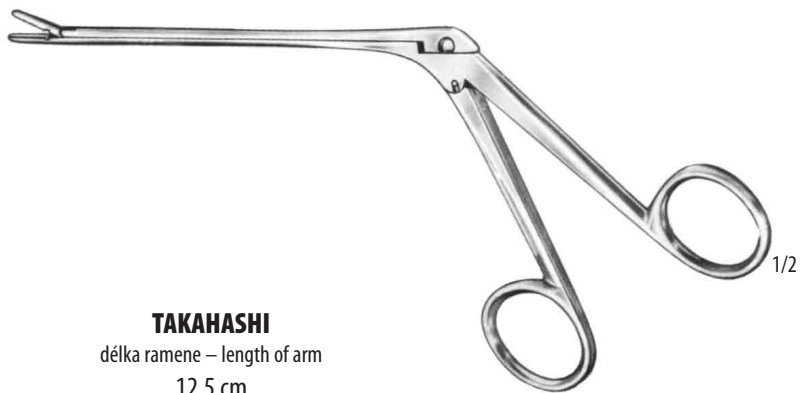

TAKAHASHI

délka ramene – length of arm
12,5 cm



116 91 0221



116 91 0222

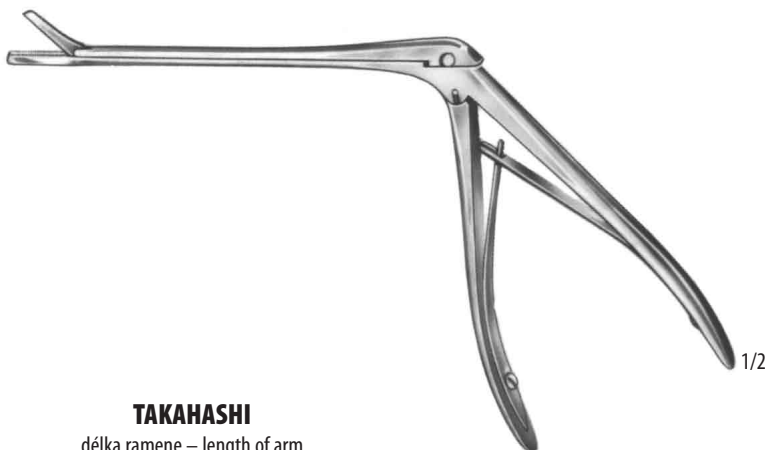

TAKAHASHI

délka ramene – length of arm
12,5 cm



JANSEN-MIDDLETON

116 91 0223
19,0 cm

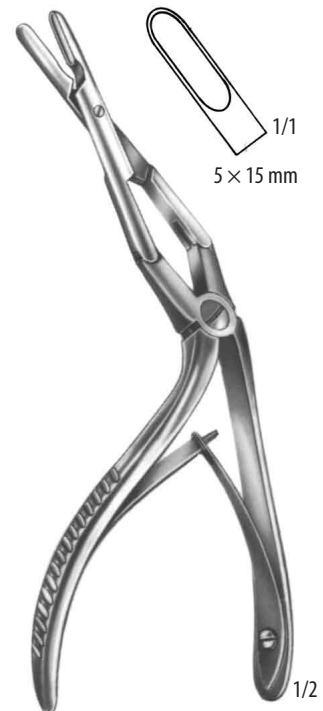

JANSEN-MIDDLETON

116 91 0224
19,0 cm

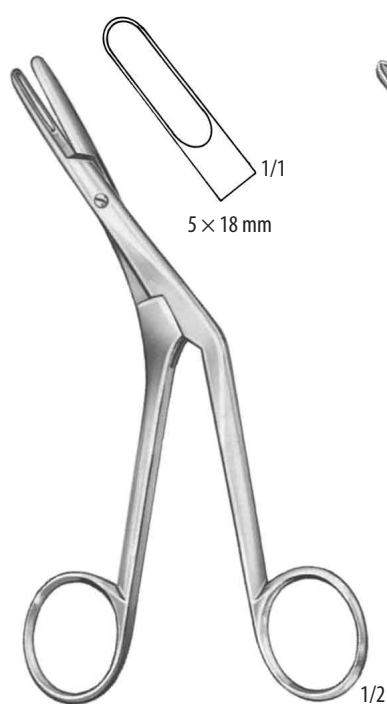
KLEŠTĚ NA NOSNÍ PŘEPÁŽKU
ETHMOID AND SEPTUM FORCEPS

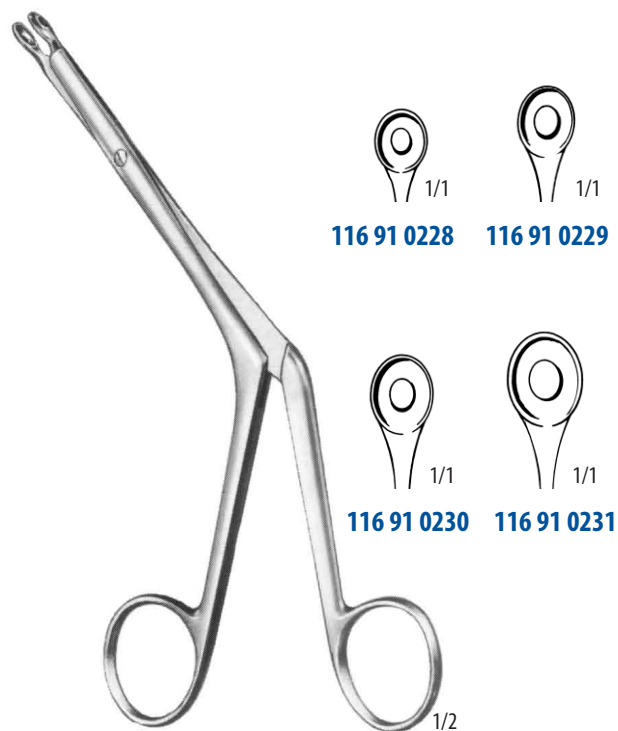
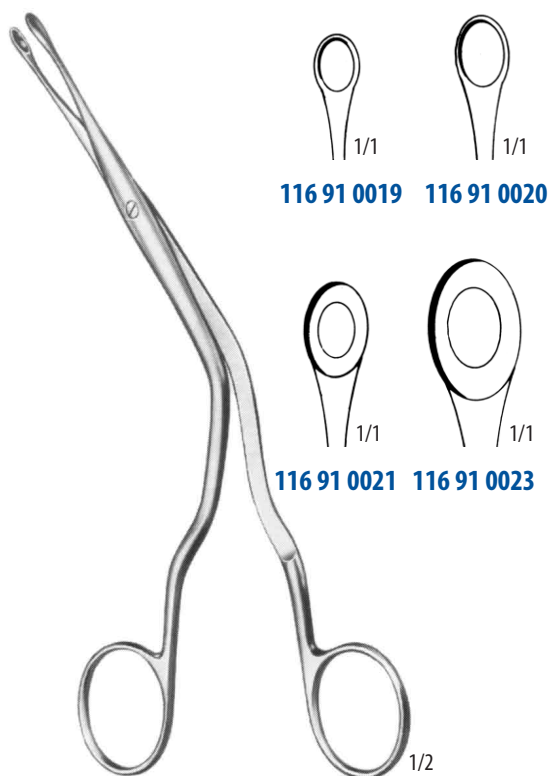
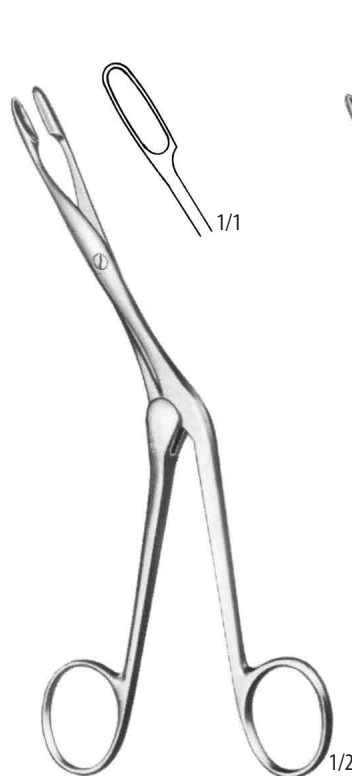
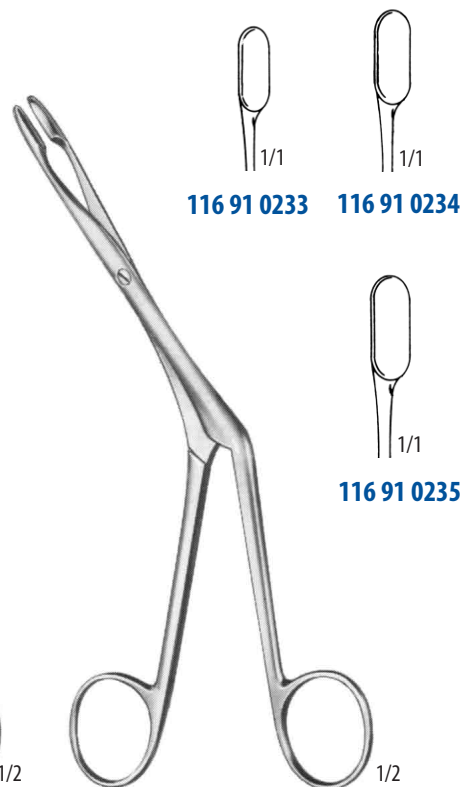
CRAIG
116 91 0225
 17,0 cm

CRAIG-DOMNICK
 17,0 cm

BRUENINGS
 19,0 cm

LUC
 20,0 cm

KNIGHT
116 91 0232
 18,0 cm

HEYMANN
 18,0 cm

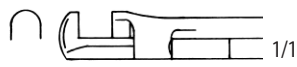

116 91 0236
4 × 4 mm



116 91 0237
4 × 4 mm



116 91 0238
3,5 × 3,5 mm



116 91 0239
3,5 × 3,5 mm

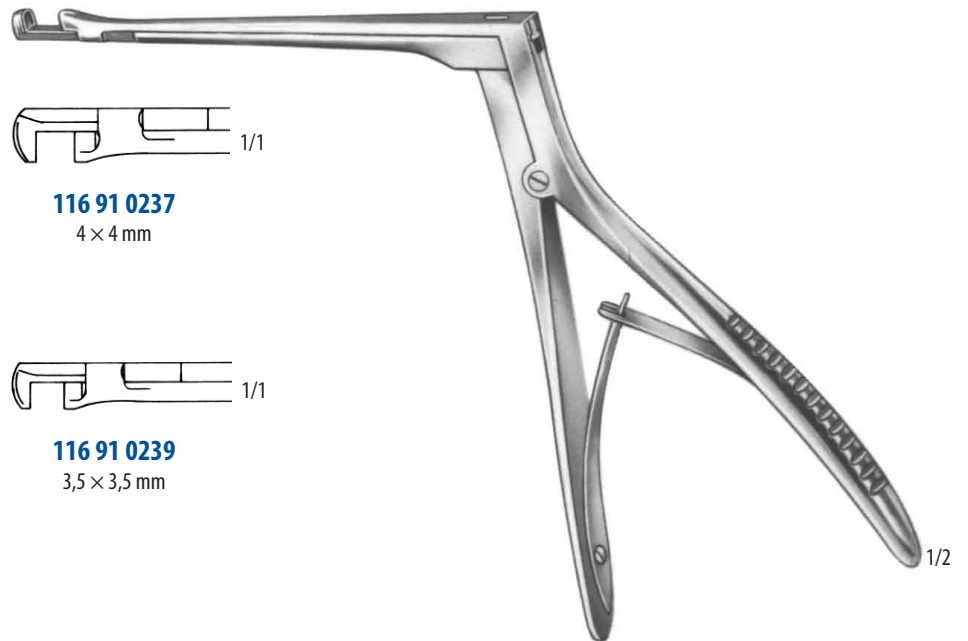

HAJEK-KOFFLER
délka ramene – length of arm
14,0 cm

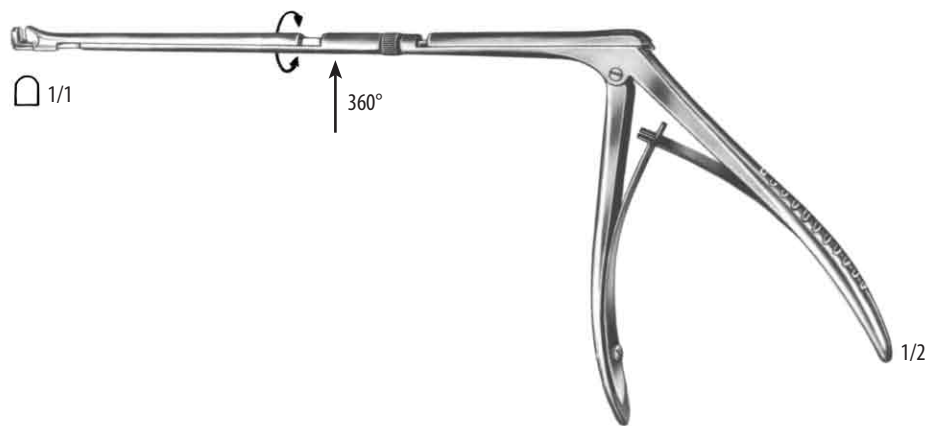

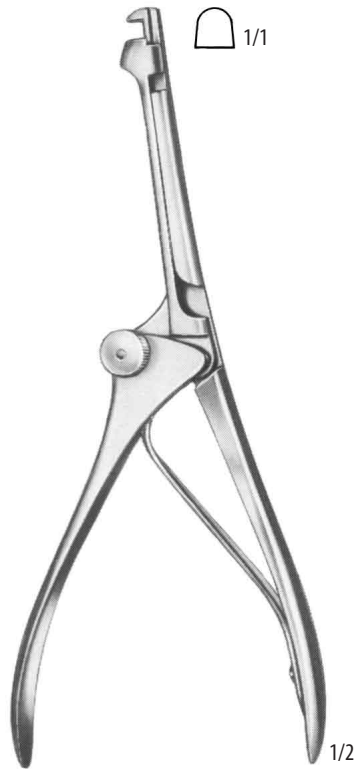

KERRISON
116 91 0240
délka ramene – length of arm
14,0 cm

ŠTÍPÁKY SFENOIDÁLNÍ
SPHENOID PUNCHES**HAJEK-CLAUS****116 91 0241**

délka ramene – length of arm
20,0 cm

 1/1
116 91 0252
3 × 3 mm

 1/1
116 91 0253
4 × 4 mm

 1/1
116 91 0254
5 × 5 mm

 1/1
116 91 0255
6 × 6 mm

**KERRISON**

délka ramene – length of arm
9,0 cm

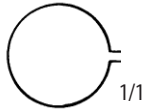

116 91 0056
Fig. 1
průměr – diameter
13 mm

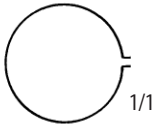

116 91 0057
Fig. 2
průměr – diameter
15 mm

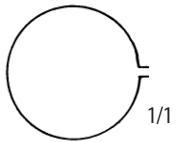

116 91 0058
Fig. 3
průměr – diameter
17 mm



HARTMANN
délka ramene – length of arm
13,0 cm

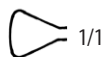

116 91 0059

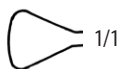

116 91 0060

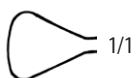

116 91 0061

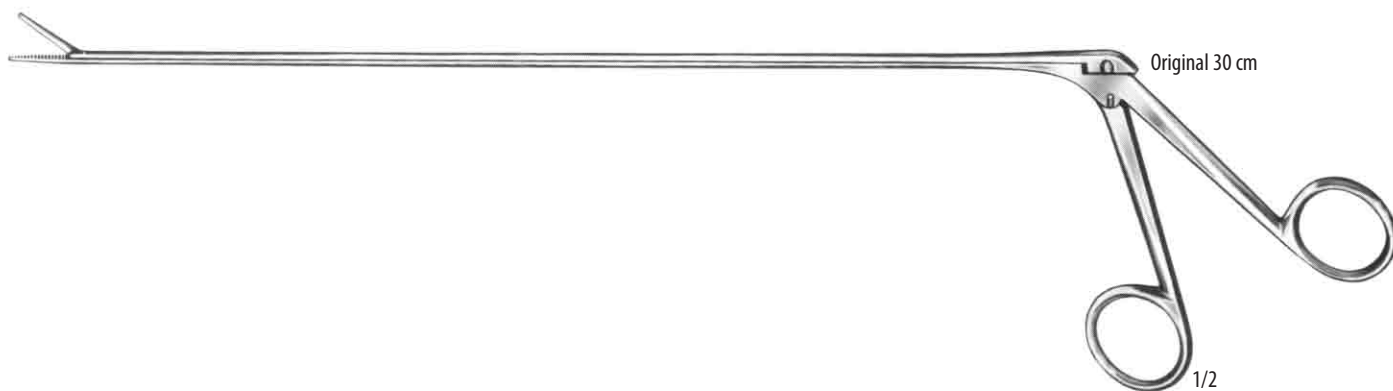

SCHMEDEN
délka ramene – length of arm
13,0 cm

KLEŠTĚ HRTANOVÉ
LARYNGEAL FORCEPS

CHEVALIER-JACKSON



1/1

Fig. 1

116 91 0062

1/1

Fig. 2

116 91 0066

1/1

Fig. 3

116 91 0070

1/1

Fig. 4

116 91 0074

délka ramene – length of arm

30,0 cm

116 91 0063**116 91 0067****116 91 0071****116 91 0075**

40,0 cm

116 91 0064**116 91 0068****116 91 0072****116 91 0076**

50,0 cm

116 91 0065**116 91 0069****116 91 0073****116 91 0077**

60,0 cm



1/1

Fig. 5

116 91 0078

1/1

Fig. 6

116 91 0082

1/1

Fig. 7

116 91 0086

1/1

Fig. 8

116 91 0090

délka ramene – length of arm

30,0 cm

116 91 0079**116 91 0083****116 91 0087****116 91 0091**

40,0 cm

116 91 0080**116 91 0084****116 91 0088****116 91 0092**

50,0 cm

116 91 0081**116 91 0085****116 91 0089****116 91 0093**

60,0 cm

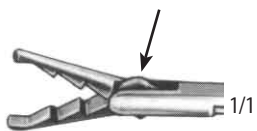

1/1

Fig. 9

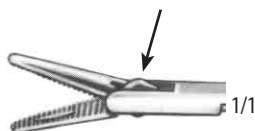
116 91 0094

1/1

Fig. 10

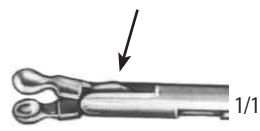
116 91 0098

1/1

Fig. 11

116 91 0102

délka ramene – length of arm

30,0 cm

116 91 0095**116 91 0099****116 91 0103**

40,0 cm

116 91 0096**116 91 0100****116 91 0104**

50,0 cm

116 91 0097**116 91 0101****116 91 0105**

60,0 cm



HUBER
116 91 0106



Original 30 cm

- BRUENINGS**
- 116 91 0107** – 20,0 cm
 - 116 91 0108** – 30,0 cm
 - 116 91 0109** – 40,0 cm
 - 116 91 0110** – 50,0 cm
 - 116 91 0111** – 60,0 cm

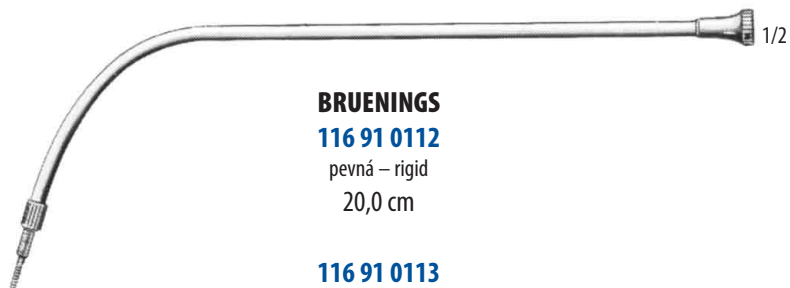

- BRUENINGS**
- 116 91 0112**
pevná – rigid
20,0 cm

- 116 91 0113**
ohybná – malleable
20,0 cm

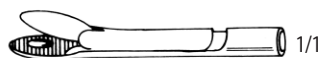

FRAENKEL
116 91 0114

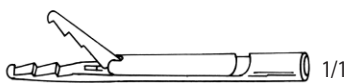

SEIFFERT
116 91 0115

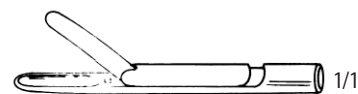

FRAENKEL
116 91 0116

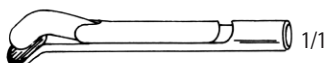

SCHEINMANN
116 91 0117

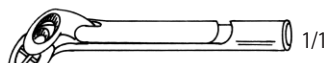

SCHEINMANN
116 91 0118

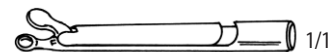

- BRUENINGS**
-  **116 91 0119** – 2 mm
 -  **116 91 0120** – 3 mm
 -  **116 91 0121** – 4 mm

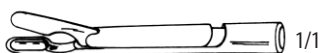

BRUENINGS
116 91 0122



116 91 0123

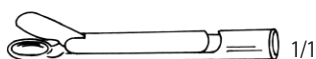

LANGE
116 91 0124

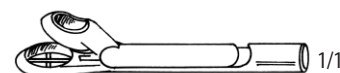

KRAUSE
116 91 0125 – 2,5 mm



116 91 0126 – 3,5 mm

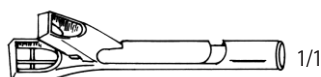

KRAUSE
116 91 0127



CORDES
116 91 0128 – Fig. 1



116 91 0129 – Fig. 2



116 91 0130 – Fig. 3



116 91 0131 – Fig. 4

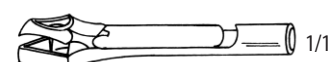

SCHUMACHER
116 91 0132

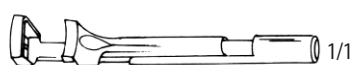

CORDES
116 91 0133 – Fig. 1



116 91 0134 – Fig. 2

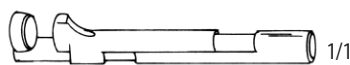

CORDES
116 91 0135



ROSENBERG
116 91 0136



1/1 **116 91 0137**

1/1 **116 91 0138**

1/1 **116 91 0139**

délka ramene – length of arm
 25,0 cm
 průměr – diameter
 2 mm

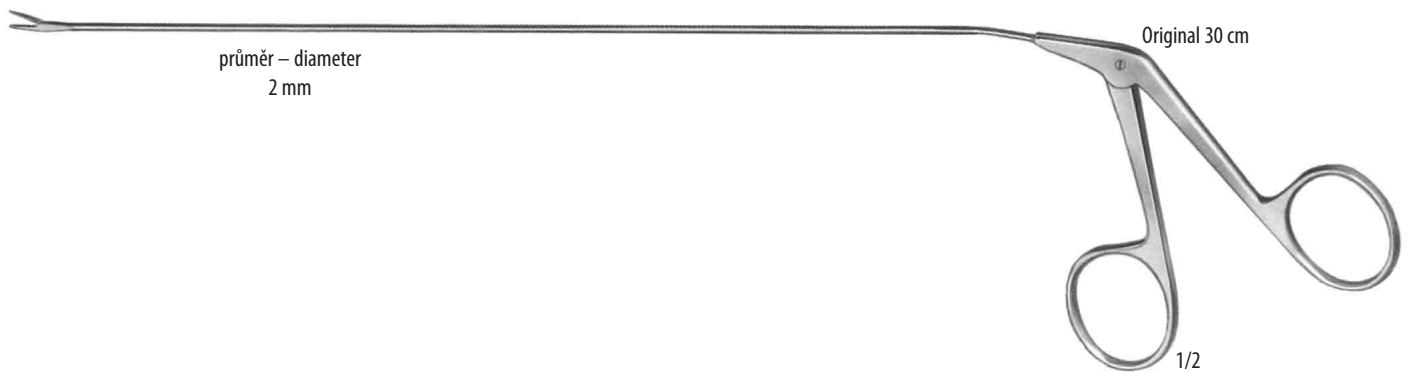
 KLEŠTĚ NA BRONCHOSKOPII
 FORCEPS FOR LARYNGO-BRONCHOSCOPY

délka ramene – length of arm				
30,0 cm	116 91 0143	116 91 0150	116 91 0157	116 91 0164
35,0 cm	116 91 0144	116 91 0151	116 91 0158	116 91 0165
délka ramene – length of arm				
40,0 cm	116 91 0145	116 91 0152	116 91 0159	116 91 0166
45,0 cm	116 91 0146	116 91 0153	116 91 0160	116 91 0167
50,0 cm	116 91 0147	116 91 0154	116 91 0161	116 91 0168
55,0 cm	116 91 0148	116 91 0155	116 91 0162	116 91 0169
60,0 cm	116 91 0149	116 91 0156	116 91 0163	116 91 0170

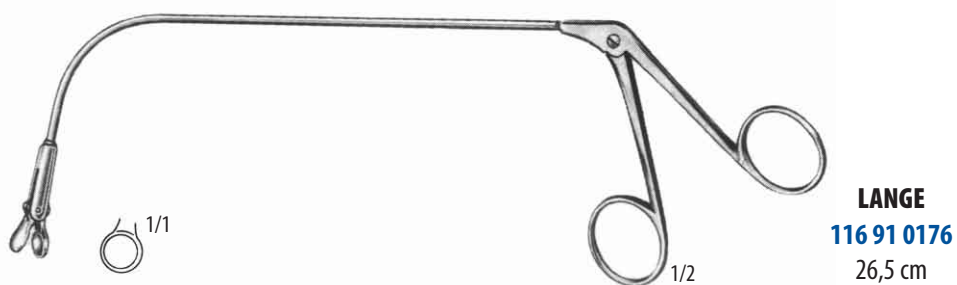
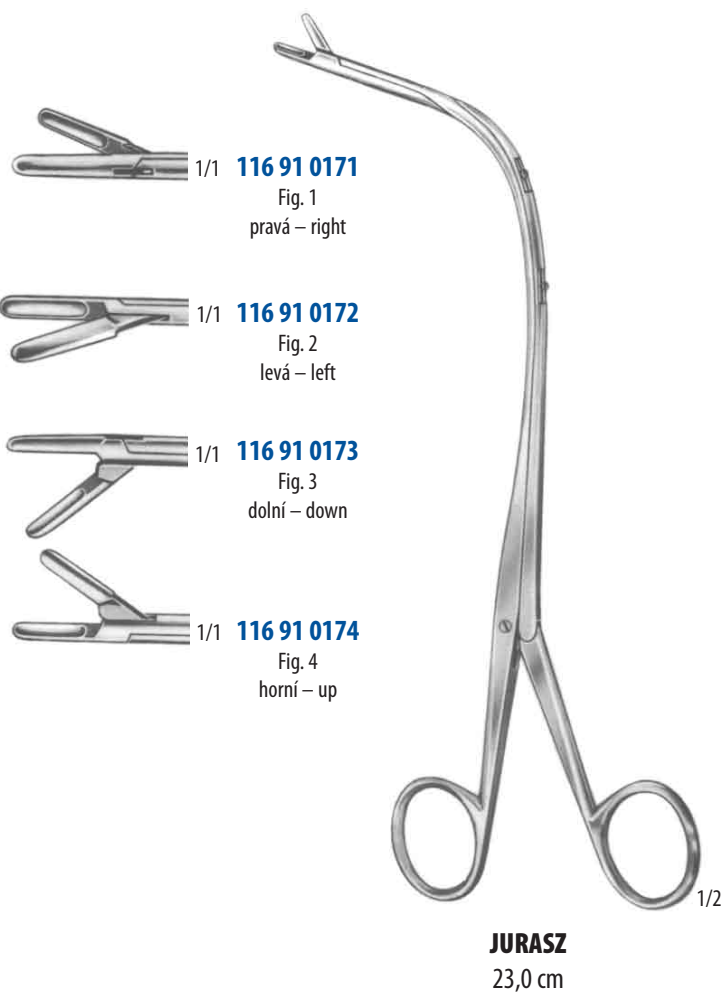
KLEŠTĚ NA POLYPY
LARYNGEAL POLYPUS FORCEPS

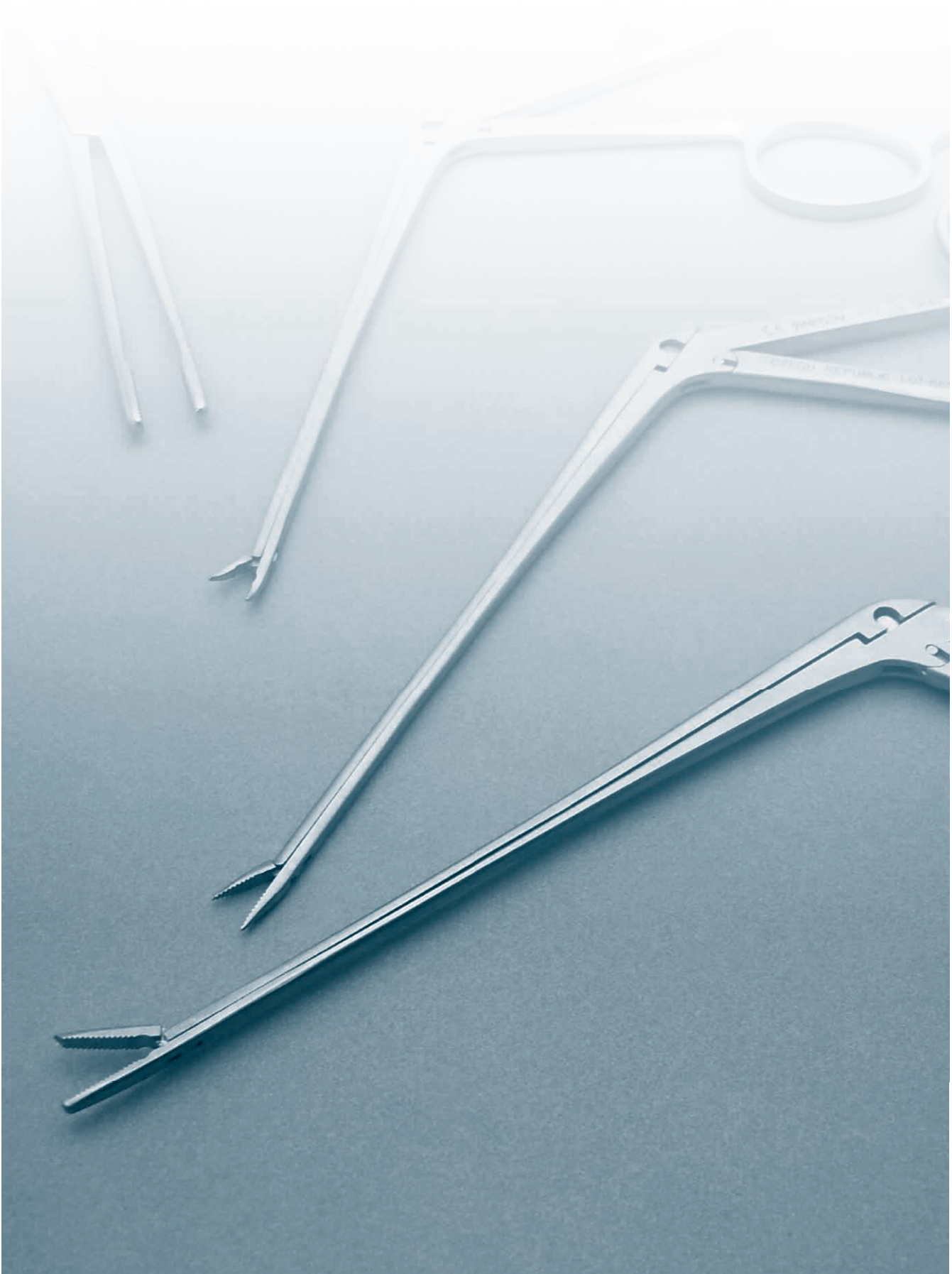





GROSS-MAIER
117 27 0260
26,0 cm

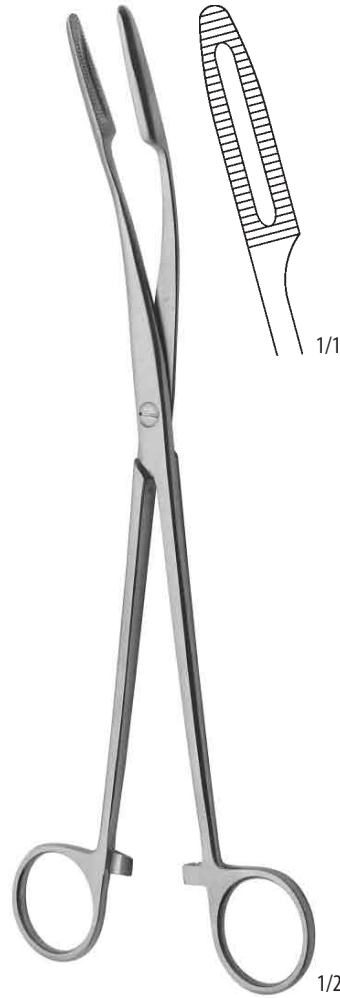

GROSS-MAIER
117 27 0280
25,7 cm

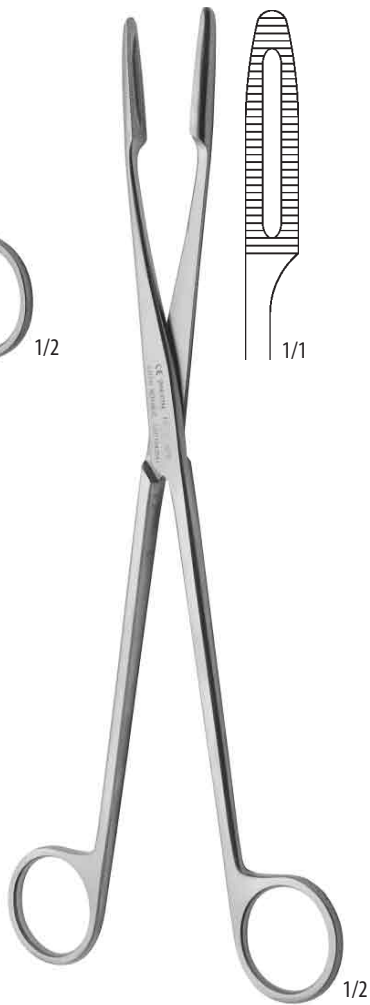

117 27 0270
26,0 cm

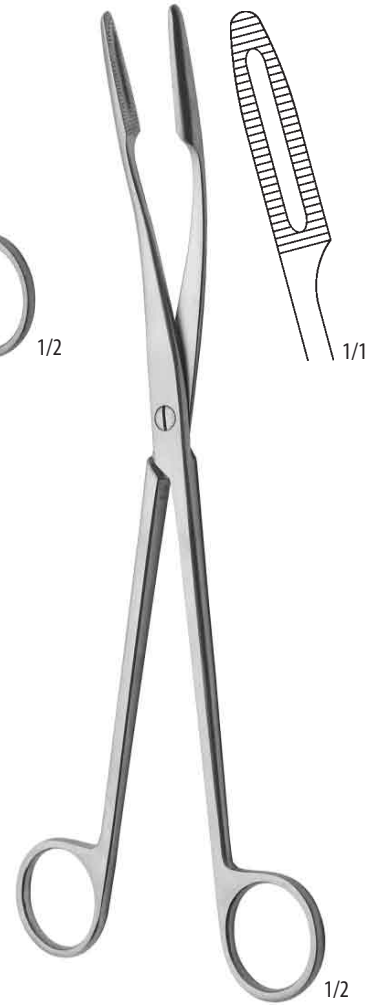

117 27 0290
25,7 cm

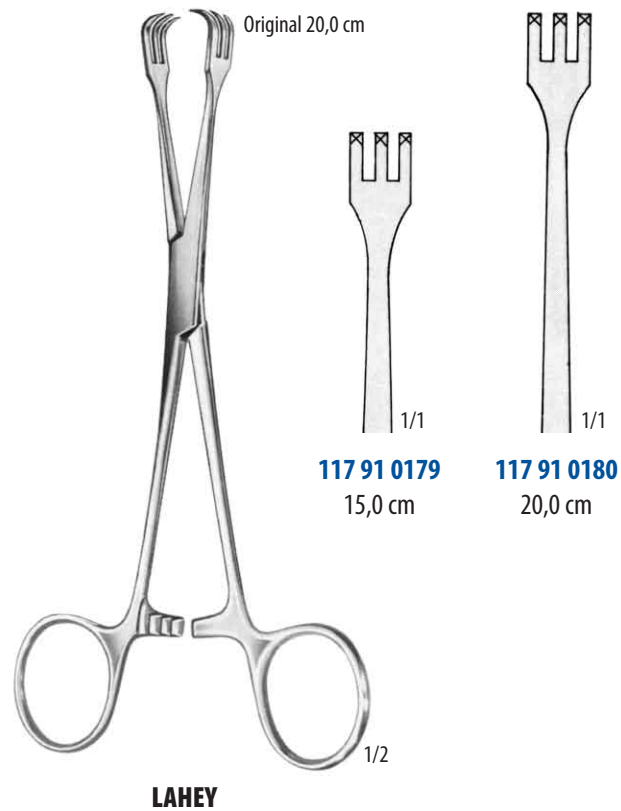
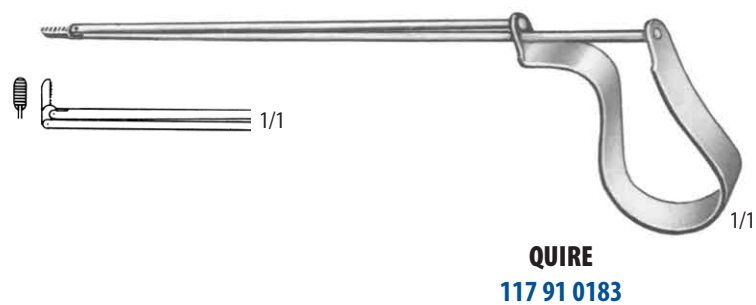
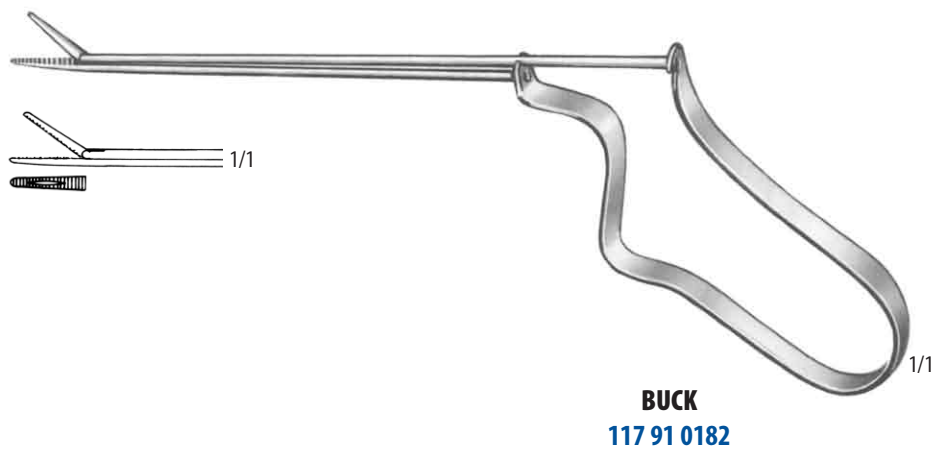
KLEŠTĚ NA CIZÍ TĚLESA
EAR FORCEPS

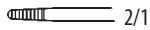

117 29 0060
 0,6 × 0,9 × 3,5 mm
 délka ramene – length of arm
 6,8 cm



117 29 0070
 0,6 × 0,9 × 5,5 mm
 délka ramene – length of arm
 7,0 cm

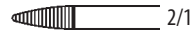

117 29 0090
 1,5 × 4,5 mm
 délka ramene – length of arm
 7,8 cm

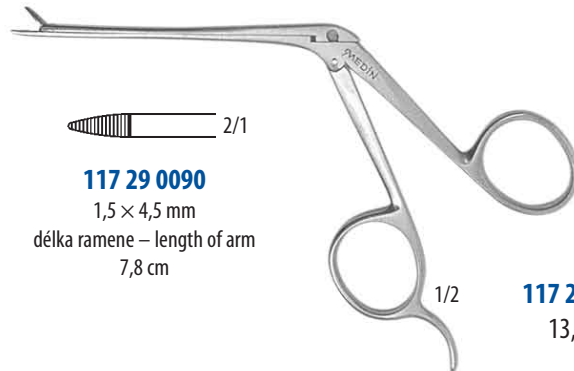

117 29 0060
 13,0 cm



117 29 0100
 2 × 7 mm
 délka ramene – length of arm
 8,3 cm

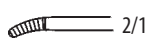

117 29 0130
 zahnuté levé – left curved
 0,6 × 0,9 × 3,5 mm
 délka ramene – length of arm
 6,8 cm

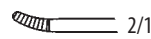

117 29 0140
 zahnuté pravé – right curved
 0,6 × 0,9 × 3,5 mm
 délka ramene – length of arm
 6,8 cm



117 29 0400
 0,8 × 2 × 5 mm
 délka ramene – length of arm
 9,8 cm



117 29 0410
 0,2 × 2 × 5 mm
 délka ramene – length of arm
 9,8 cm



117 29 0420
 0,8 × 2 × 5 mm
 délka ramene – length of arm
 9,8 cm

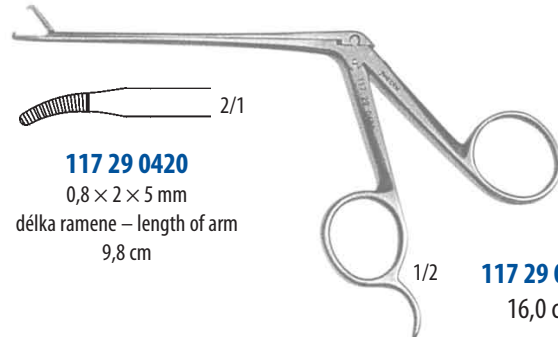

117 29 0480
 16,0 cm



117 29 0430
 0,8 × 2 × 5 mm
 délka ramene – length of arm
 9,8 cm



117 29 0440
 0,5 × 2 × 5 mm
 délka ramene – length of arm
 9,8 cm



117 29 0450
 0,8 × 2 × 8,5 mm
 délka ramene – length of arm
 10,2 cm

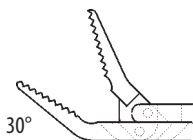

117 29 0460
 0,8 × 2 × 5 mm
 délka ramene – length of arm
 9,8 cm



117 29 0470
 1,2 × 2 × 5 mm
 délka ramene – length of arm
 9,8 cm



117 29 0480
 1,5 × 2 × 8 mm
 délka ramene – length of arm
 9,8 cm
 (1 × 2)

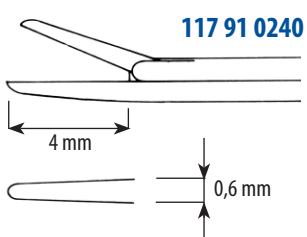
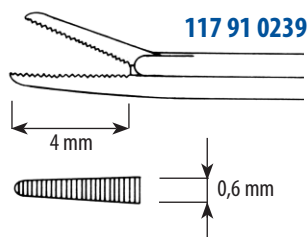
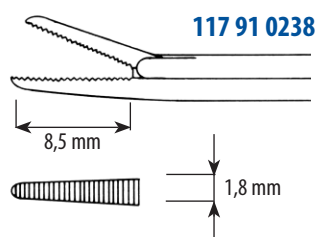
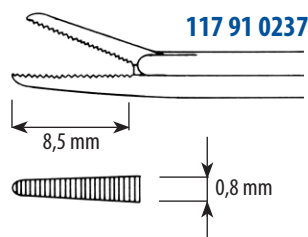
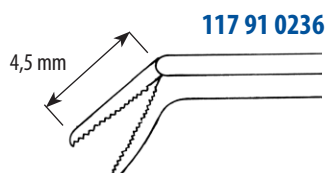
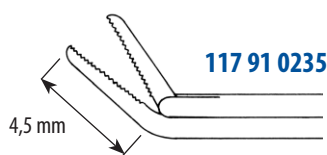
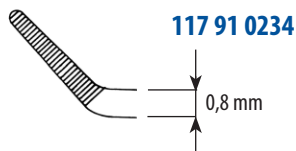
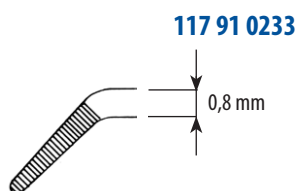
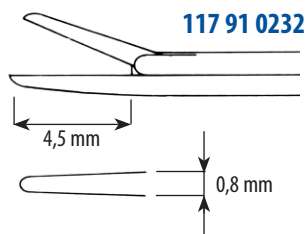
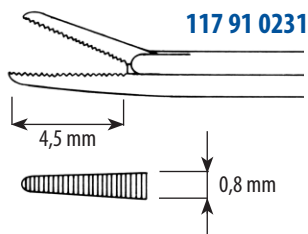

délka ramene – length of arm
8,0 cm



HARTMANN
117 91 0190



DUCKBILL
117 91 0191



WEINGÄRTNER
117 91 0192

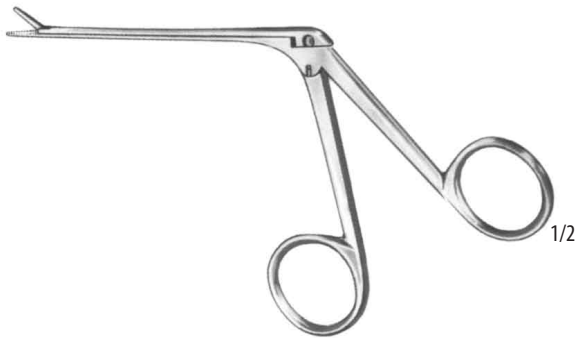

délka ramene – length of arm
8,5 cm

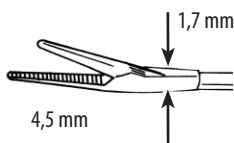

WULLSTEIN
117 91 0241

délka ramene – length of arm
8,0 cm

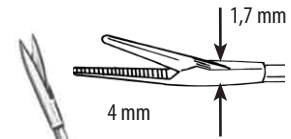

WULLSTEIN
117 91 0242

19,0 cm

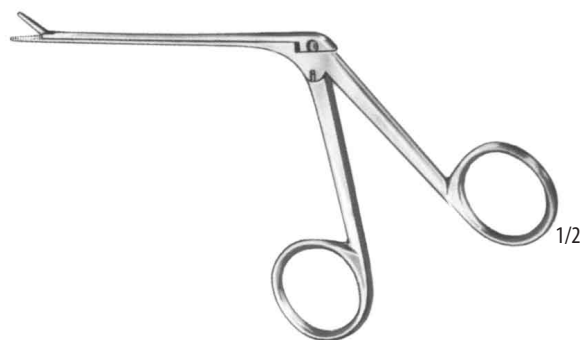
KLEŠTĚ NA POLYPY, KLEŠTĚ NA NOSNÍ POLYPY
EAR FORCEPS, NASAL POLYPUS FORCEPS
**HARTMANN-WULLSTEIN****117 91 0184**délka ramene – length of arm
8,5 cm**HARTMANN****117 91 0186**délka ramene – length of arm
8,5 cm**HARTMANN****117 91 0188**délka ramene – length of arm
8,5 cm**HARTMANN-WULLSTEIN****117 91 0185**délka ramene – length of arm
8,5 cm**HARTMANN****117 91 0187**délka ramene – length of arm
14,0 cm**HARTMANN****117 91 0189**délka ramene – length of arm
14,0 cm**HARTMANN**

20,4 cm

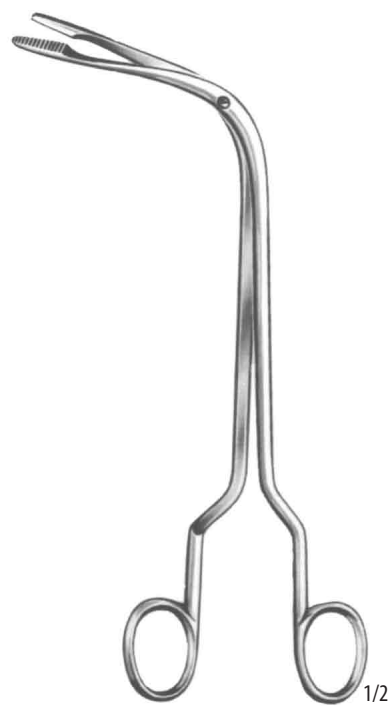
**FRAENKEL****117 91 0181**

18,0 cm

Original 16,0 cm



HARTMANN
117 91 0215 117 91 0216
16,0 cm 20,0 cm

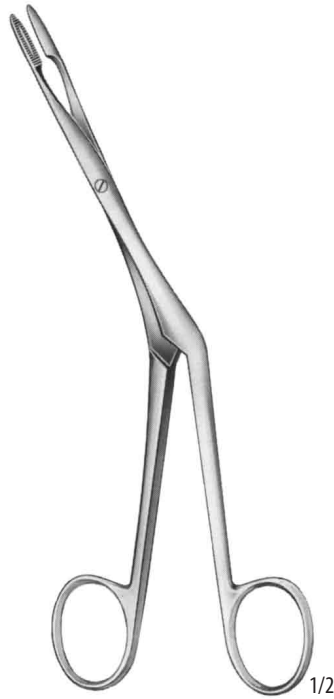

HEYMAN-KNIGHT
117 91 0217
18,0 cm

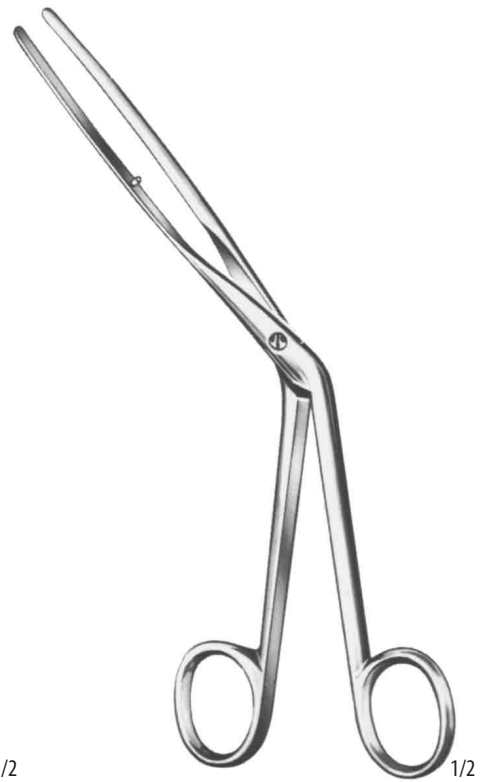

LUBET-BARBON
117 91 0218
20,0 cm



KILLIAN
117 91 0219
17,0 cm

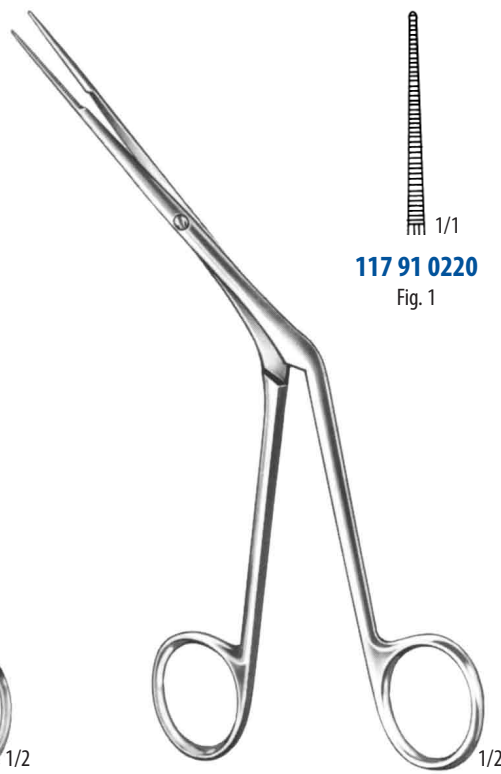

WESTMACOTT
20,0 cm

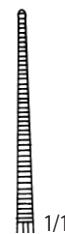

117 91 0220
Fig. 1

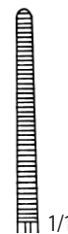

117 91 0221
Fig. 2



ASCH
117 91 0222
23,0 cm

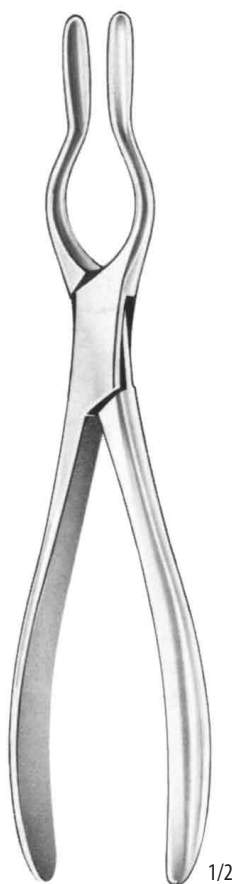

WALSHAM
23,0 cm

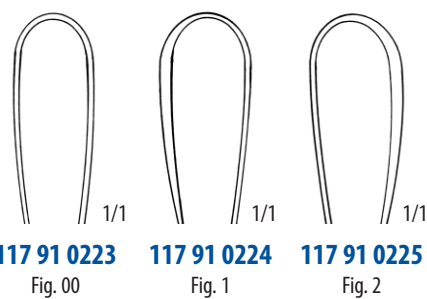

COTTLE-WALSHAM
117 91 0226
22,0 cm



RUBIN
117 91 0227
20,0 cm



KRESSNER
20,0 cm

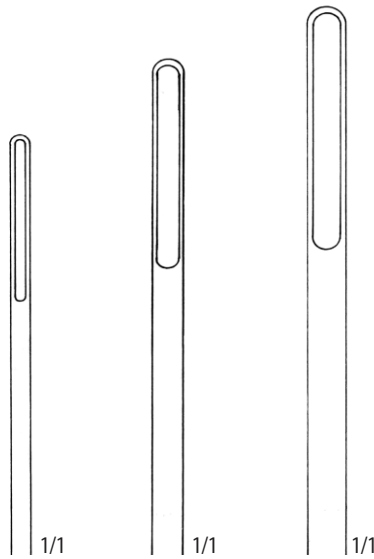

117 91 0228 2,5 × 60 mm
117 91 0229 4 × 70 mm
117 91 0230 5 × 75 mm

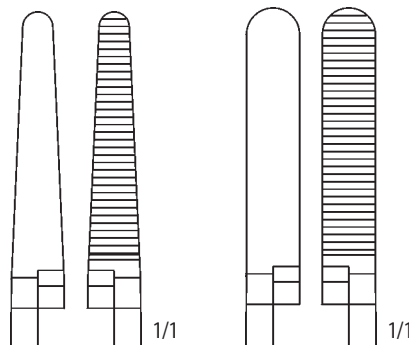

117 30 0400 18,3 cm
4 mm
117 30 0410 18,3 cm
7 mm

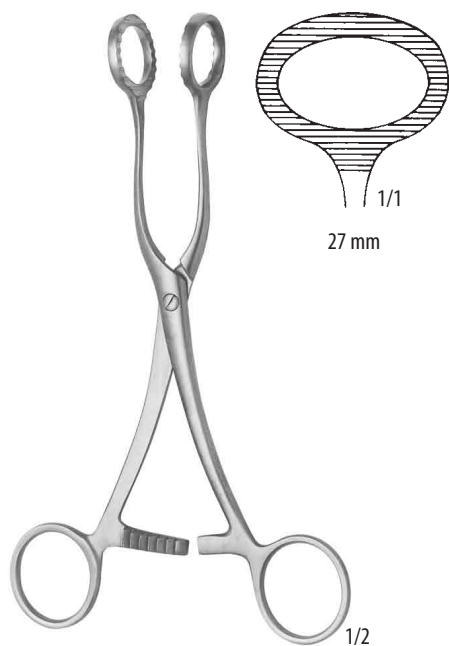
KLEŠTĚ NA JAZYK
TONGUE HOLDING FORCEPS

COLLIN
117 31 0010
16,7 cm

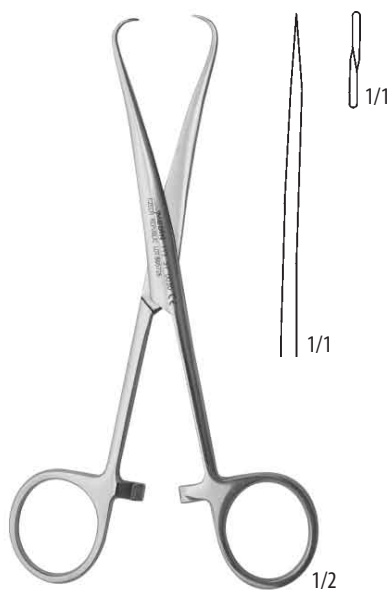

LÖBKER
117 31 0030
15,0 cm



YOUNG
117 91 0177
17,0 cm

117 91 0178
pár – pair

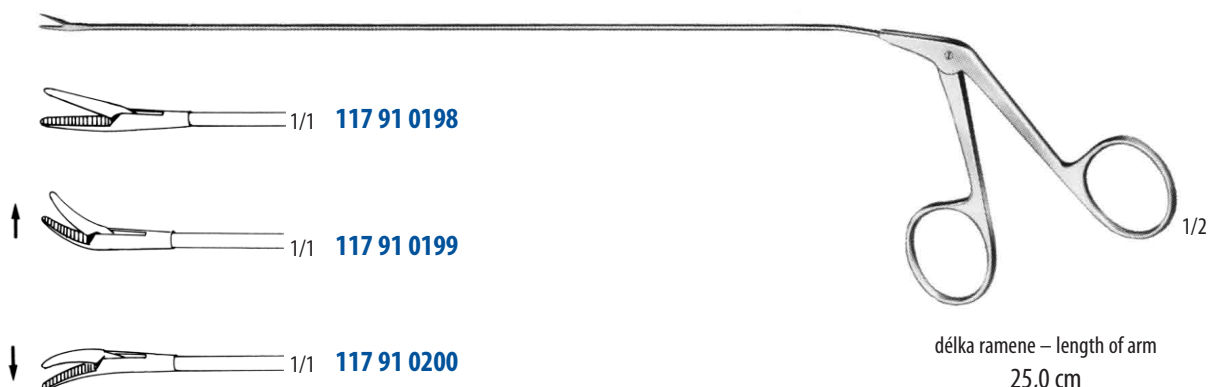
ENDOLARYNGEÁLNÍ MIKRO KLEŠTĚ
ENDOLARYNGEAL MICRO FORCEPS

117 91 0198

117 91 0199

117 91 0200

délka ramene – length of arm
25,0 cm
průměr – diameter
2 mm



WHITE
117 91 0193 18,0 cm
117 91 0194 23,0 cm

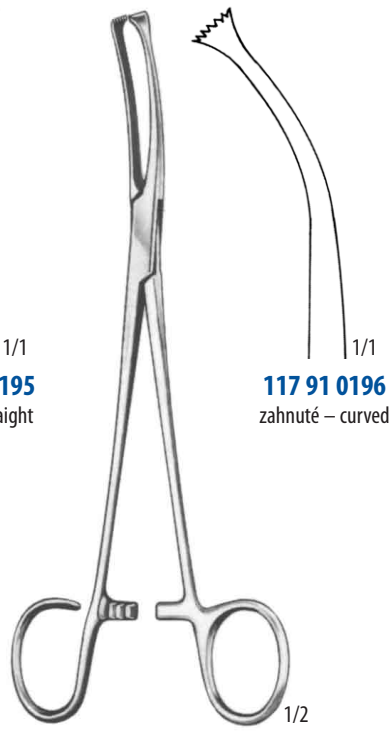

COLVER
 19,0 cm



MUSEUX
117 91 0197
 20,0 cm



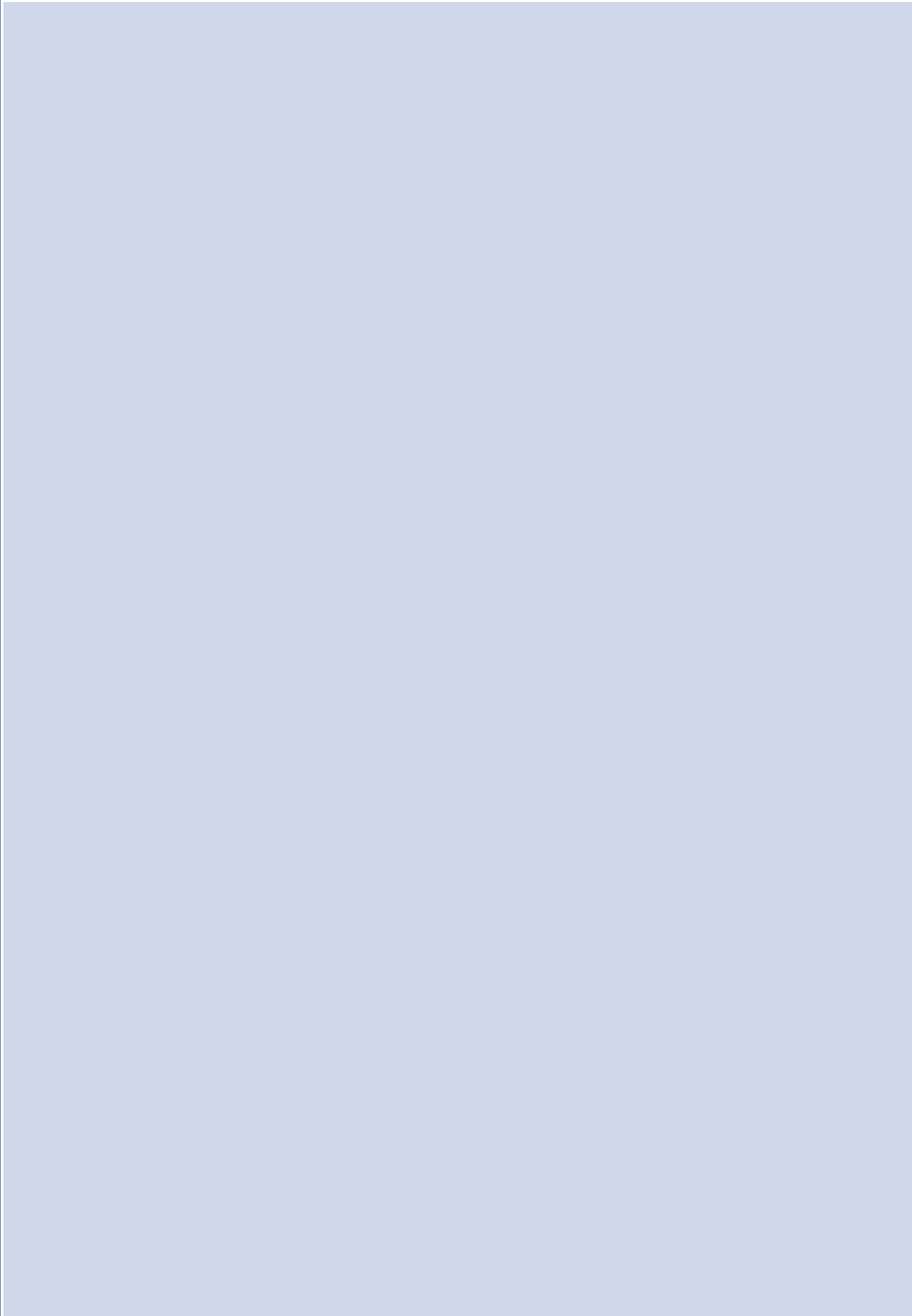

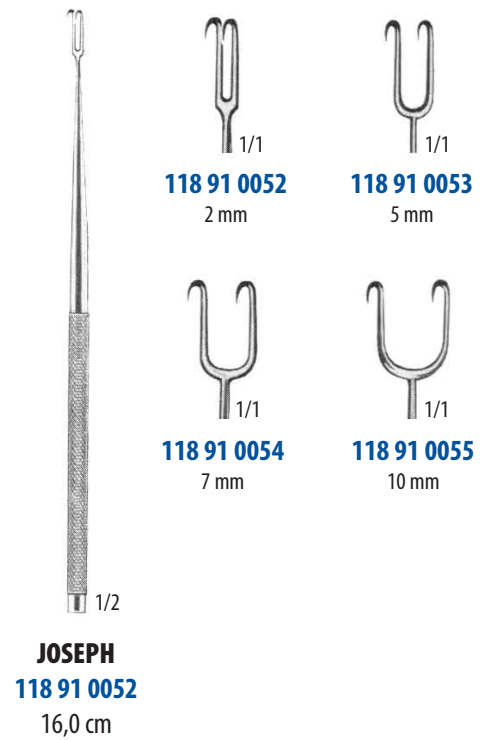
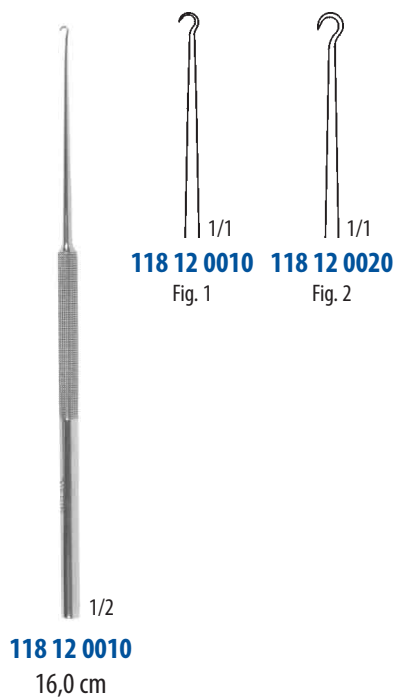
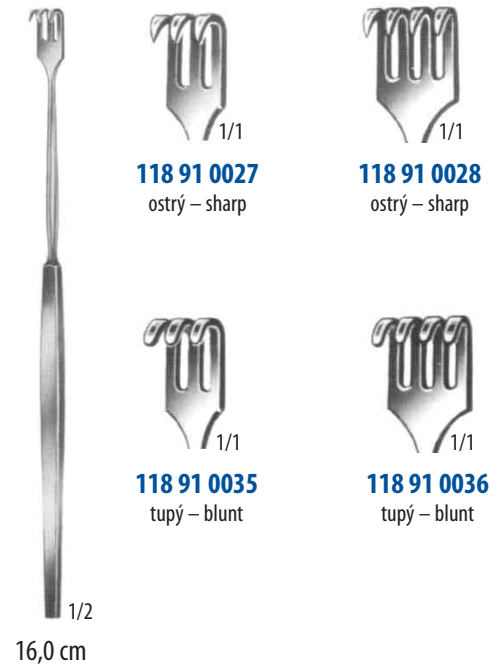

HÁKY JEMNÉ
DELICATE HOOKS

118 91 0046
ohebný – flexible
16,0 cm



118 91 0045



118 91 0048



118 91 0046



118 91 0049



118 91 0047
ostrý – sharp



118 91 0050
tupý – blunt



118 91 0109
ostrý – sharp

1/2



118 91 0110
tupý – blunt

1/1

SENN-MILLER
16,0 cm



DESMARRES
13,0 cm



118 38 0020
12 mm



118 91 0077
16 mm



118 38 0010
10 mm



118 38 0030
14 mm



118 91 0078
18 mm



GIL-VERNET
24,5 cm



118 91 0097
9 mm



118 91 0100
15 mm



118 91 0098
11 mm



118 91 0101
18 mm



HARTMANN
118 29 0010
17,0 cm



BERTHOLD
118 29 0040
18,0 cm



SCHWARTZE
118 29 0060
17,0 cm



LUDEWIG
17,0 cm

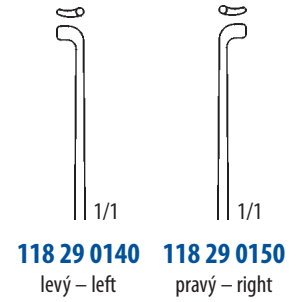

TROELTSCH
118 29 0070
20,5 cm
27 mm



HARTMANN
118 91 0419
16,5 cm



ZAUFAL
118 91 0420
16,5 cm



WAGENER
14,0 cm

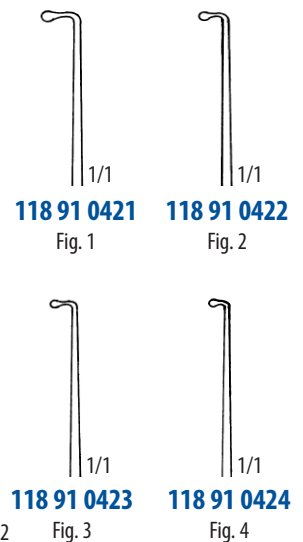

HÁKY JEMNÉ NOSNÍ
 NASAL DELICATE HOOKS

COTTLE
118 91 0332
 16,0 cm



FOMON
118 91 0333
 17,0 cm



LANGE
118 91 0334
 22,0 cm



FOMON
118 91 0335
 16,0 cm



FREER
118 91 0336
 15,0 cm



HÁČEK NA KŘÍDLO NOSNÍ
 NASAL ALAR HOOK
118 12 0090
 10,5 cm



COTTLE (MILLARD)
118 91 0340



KILNER
118 91 0341
 10,0 cm



COTTLE
118 91 0342
 14,0 cm



COTTLE-NEIVERT
118 91 0343
20,0 cm



CONVERSE
118 91 0344
12,0 cm

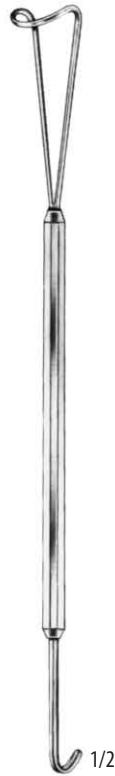

MASING
118 91 0345
20,0 cm



COTTLE
118 91 0346
15,0 cm



COTTLE
118 91 0347
15,0 cm



COTTLE
14,0 cm



118 91 0337

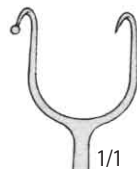

118 91 0338



118 91 0339



118 12 0050
16,0 cm



118 12 0050
5 mm

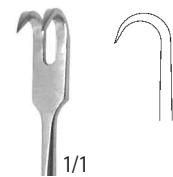

118 12 0060
5 mm



118 12 0070
12 mm
tupý – blunt



118 12 0080
12 mm
ostrý – sharp



AUFRICHT (WALTER)
118 91 0348
13,5 cm



AUFRICHT
118 91 0349
19,0 cm



HÁK NA CHOANÁLNÍ POLYPY
CHOANAL HOOK
118 30 0120
22,5 cm



118 31 0040
rovný – straight
16,4 cm

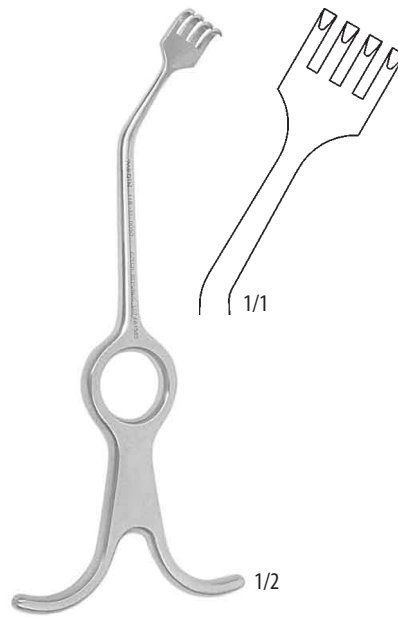

118 31 0050
pravý – right
16,2 cm

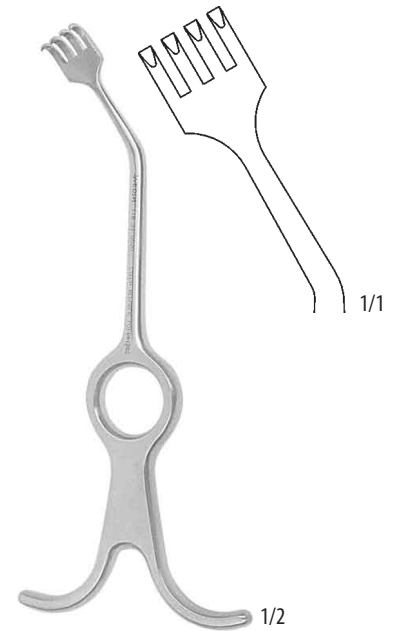

118 31 0060
levý – left
16,2 cm



118 31 0070
rovný – straight
16,4 cm

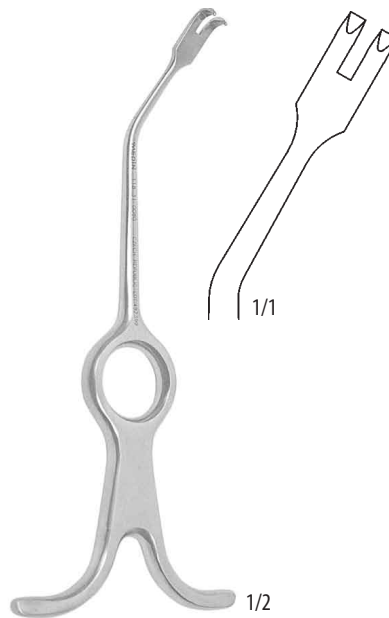

118 31 0080
pravý – right
16,1 cm

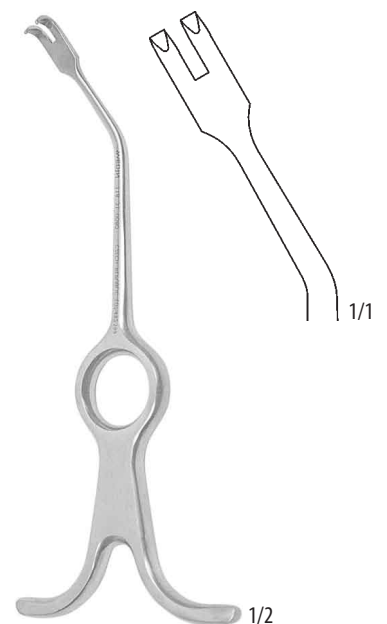

118 31 0090
levý – left
16,1 cm

HÁKY NA RÁNY
RETRACTORS

MIDDELDORPF
118 08 0650



118 08 0650
14 × 12 mm
22,0 cm



118 08 0660
21 × 21 mm
22,0 cm



118 08 0670
32 × 31 mm
23,5 cm



118 08 0680
62 × 50 mm
28,0 cm



CALDWELL-LUC
118 08 0780
23,0 cm

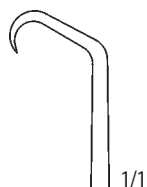

118 08 0760
12 × 13 mm

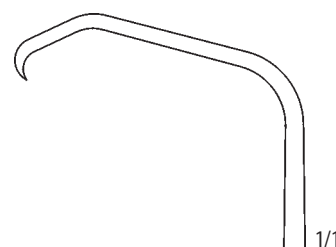

118 08 0770
37 × 13 mm

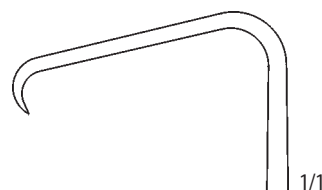

118 08 0780
35 × 13 mm



118 34 0020
23,5 cm

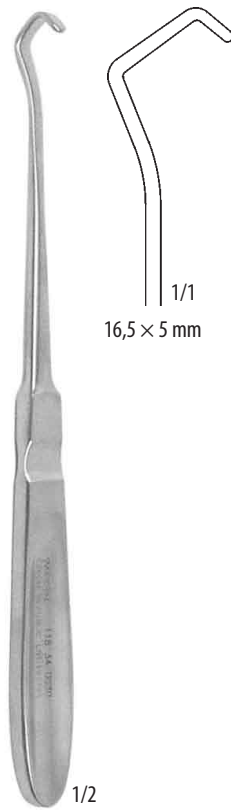

118 34 0030
21,0 cm



LUKENS
118 91 0323
17,0 cm



BOSE
118 91 0318
levý – left
16,0 cm



BOSE
118 91 0319
pravý – right
16,0 cm



ITERSON
16,0 cm

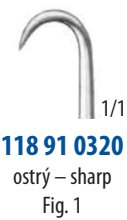

118 91 0320
ostrý – sharp
Fig. 1



118 91 0321
tupý – blunt
Fig. 2

HÁKY TRACHEÁLNÍ
TRACHEAL HOOKS

JACKSON
18,0 cm



JACKSON
118 91 0326
17,0 cm

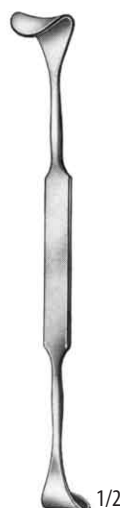

ROSE
118 91 0327
13,0 cm



LUER
118 91 0328
11,0 cm



JACKSON
118 91 0329
15,0 cm



NEWS
118 91 0330
15,0 cm



REICHERT
118 91 0331
24,0 cm



HOFER
118 91 0382
24,0 cm



NAGER
118 91 0383
23,0 cm



LOWE
118 91 0384 – 18,0 cm
118 91 0385 – 20,0 cm
118 91 0386 – 22,0 cm

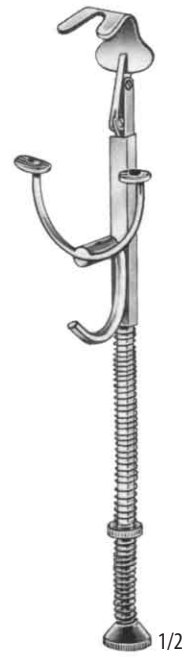

HASLINGER
118 91 0387
17,0 cm







1/2

FINSEN

ostrý – sharp

119 91 0001 – 5,0 cm (2 × 3)

119 91 0002 – 7,0 cm (3 × 4)

tupý – blunt

119 91 0003 – 5,0 cm (2 × 3)

119 91 0004 – 7,0 cm (3 × 4)

1/2

ROSER-KÖNIG
119 07 0010

19,5 cm



1/2

DENHART
119 91 0199

12,0 cm



1/2

HEISTER
119 07 0020

13,0 cm



1/2

JANSEN
119 91 0013 – 10,0 cm (4 × 4)

ostrý – sharp

119 91 0014 – 10,0 cm (4 × 4)

tupý – blunt



1/2

MOLT
119 91 0197

dětské – for children

11,0 cm



1/2

MOLT
119 91 0198

14,0 cm

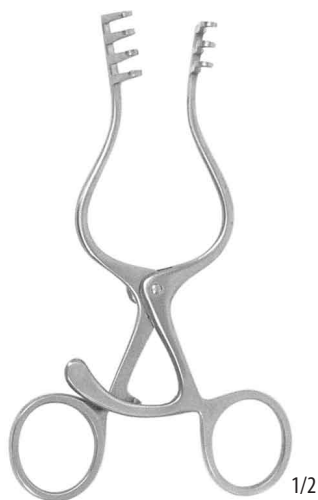
**WEITLANER**

ostrý – sharp

tupý – blunt

119 08 0100 – 13,0 cm – **119 08 0110**
(3 × 4)

tupý – blunt

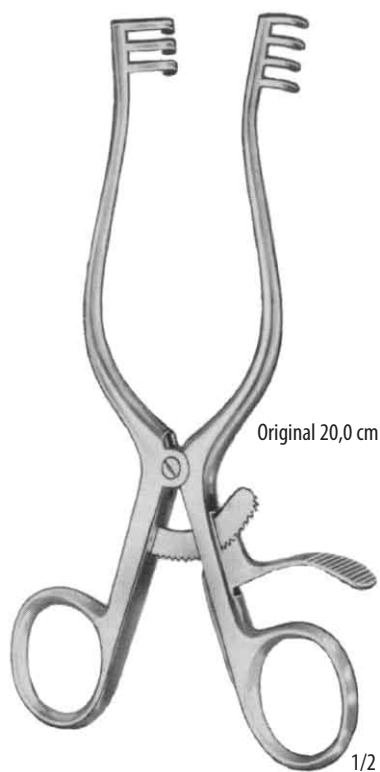
119 08 112014,5 cm
(3 × 4)**WEITLANER**

ostrý – sharp

tupý – blunt

119 91 0020	– 10,5 cm –	119 91 0021	(2 × 3)
119 08 1040	– 13,5 cm –	119 08 1060	(3 × 4)
119 08 0680	– 16,5 cm –	119 08 0690	(3 × 4)
119 91 0026	– 20,0 cm –	119 91 0027	(3 × 4)

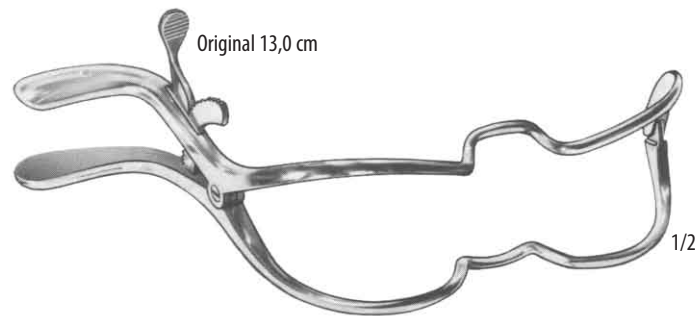
JENNINGS

119 91 0185	9,0 cm
119 91 0186	11,0 cm
119 91 0187	13,0 cm
119 91 0188	15,0 cm

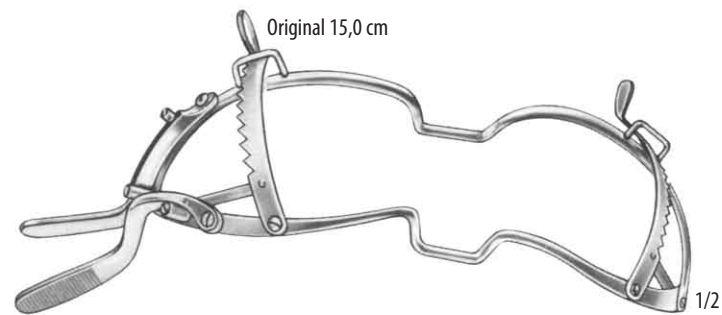
WHITEHEAD

119 91 0189	9,0 cm
119 91 0190	11,0 cm
119 91 0191	13,0 cm
119 91 0192	15,0 cm

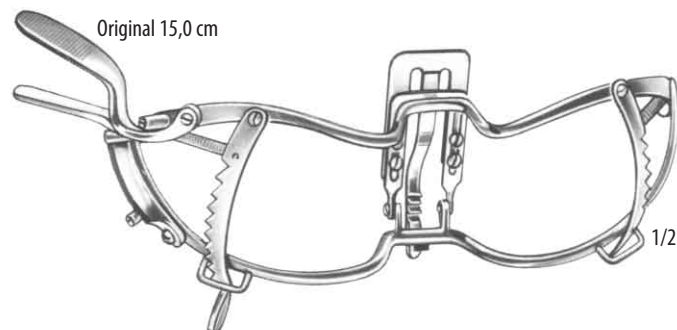
WHITEHEAD

119 91 0193	9,0 cm
119 91 0194	11,0 cm
119 91 0195	13,0 cm
119 91 0196	15,0 cm

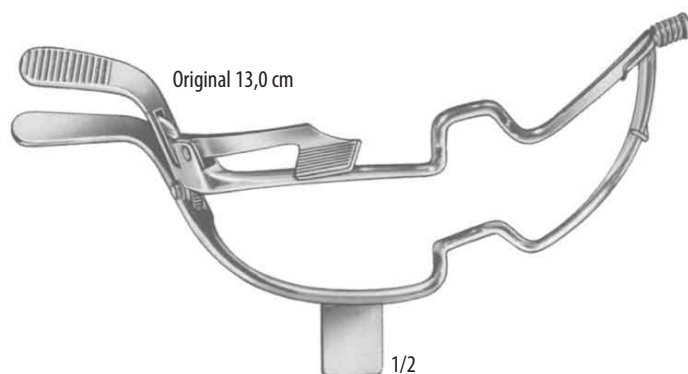
**SEEMANN-SEIFFERT**

119 91 0200	9,0 cm
119 91 0201	11,0 cm
119 91 0202	13,0 cm
119 91 0203	15,0 cm

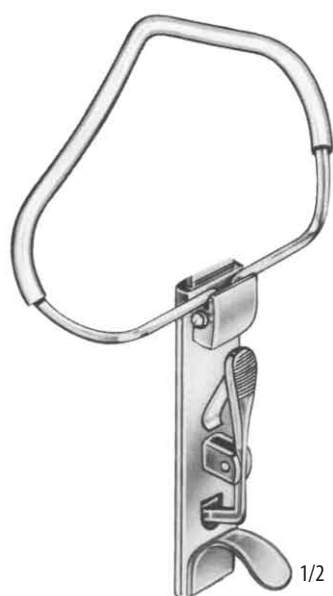

119 91 0226
rám – gag only

MC IVOR
119 91 0222
komplet – complete

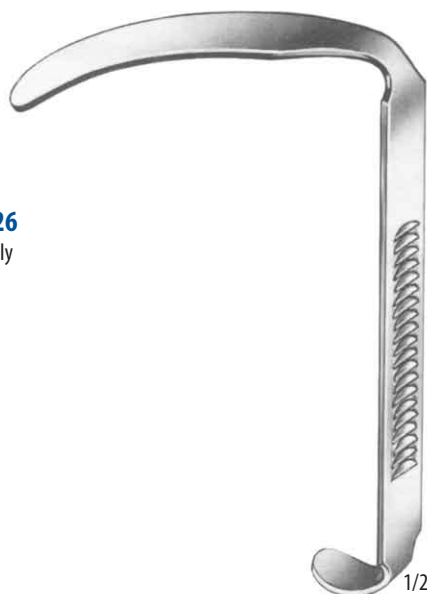

119 91 0223
95 × 27 mm
Fig. 1



119 91 0224
85 × 22 mm
Fig. 3

119 91 0225
70 × 22 mm
Fig. 3



119 91 0208
 rám – gag only

KILNER-DOUGHTY
119 91 0204
 komplet – complete



119 91 0205
 65 × 28 mm
 Fig. 1



119 91 0206
 75 × 32 mm
 Fig. 2



119 91 0207
 80 × 37 mm
 Fig. 3



119 91 0209
 pro bezzubé – for toothless

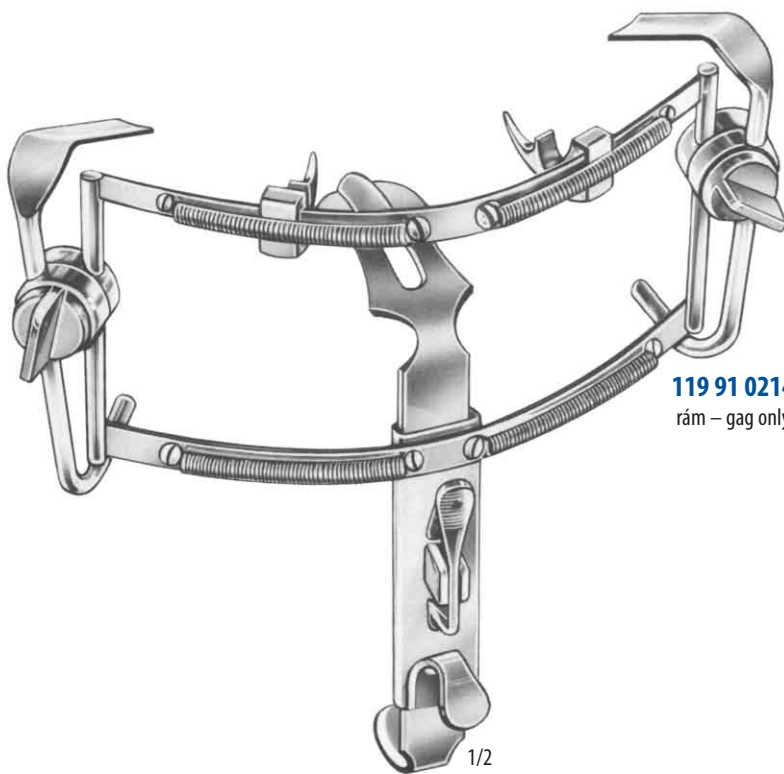

119 91 0214
 rám – gag only

DINGMANN
119 91 0210
 komplet – complete



119 91 0211
 55 × 25 mm
 Fig. 1



119 91 0212
 60 × 27 mm
 Fig. 2



119 91 0213
 70 × 30 mm
 Fig. 3



119 91 0221
rám – gag only

DAVIS-BOYLE
119 91 0215
komplet – complete



119 91 0216
105 × 27 mm
Fig. 1



119 91 0217
90 × 25 mm
Fig. 2



119 91 0218
75 × 25 mm
Fig. 3



119 91 0219
60 × 22 mm
Fig. 4



MODEL WÜRZBURG

119 91 0227	66 × 28 mm	Fig. 1
119 91 0228	75 × 32 mm	Fig. 2
119 91 0229	83 × 34 mm	Fig. 3
119 91 0230	93 × 37 mm	Fig. 4
119 91 0231	100 × 38 mm	Fig. 5



119 91 0220
60 × 22 mm
Fig. 5



NEGUS
 119 91 0232



STERNBERG
 119 91 0233 12,0 cm
 119 91 0234 14,0 cm
 119 91 0235 16,0 cm



LABORDE
 119 91 0236
 14,0 cm



BOSE
 119 91 0237
 7,0 cm



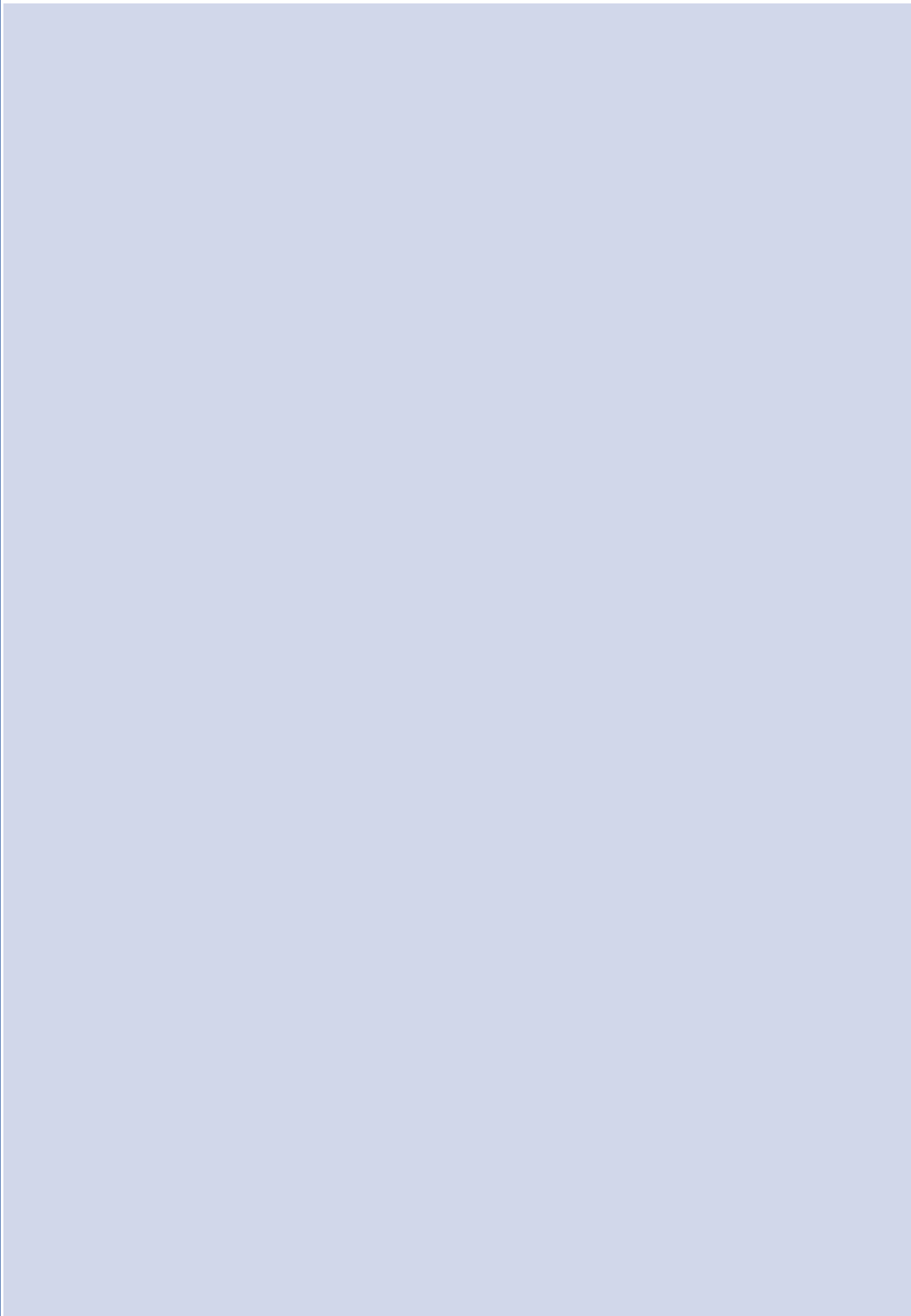



1/2

BUCHWALD
121 31 0010

 17,3 cm
16/23 mm

1/2

BRUENINGS
121 31 0020

 19,5 cm
14/18 mm

1/2

SIMPLEX
121 91 0013

11,0 cm



1/2

TOBOLD
121 91 0014

14,5 cm

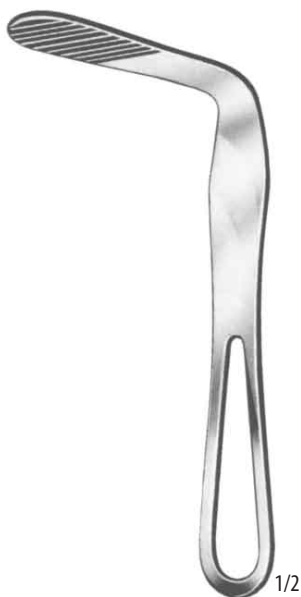

1/2

HARTMANN
121 31 0040

15,0 cm



1/2

MORITZ-SCHMIDT
121 91 0016

19,0 cm



1/2

WIEDER
14,5 cm

Original 28 mm

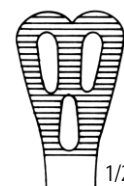

1/2

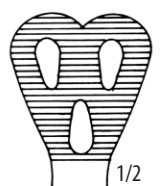
121 91 0017
28 mm

1/2

121 91 0018
32 mm



121 91 0019
19,0 cm



STANDARD
121 91 0020
14,5 cm

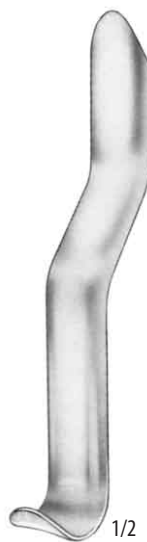

UNIV. MINNESOTA
121 91 0021
14,0 cm



KROENIG
121 91 0022
15,0 cm



MAYO
121 91 0023
17,0 cm



BRUENINGS
121 91 0024
19,0 cm



FRENZEL
121 91 0025
16,5 cm



121 91 0026
18,0 cm

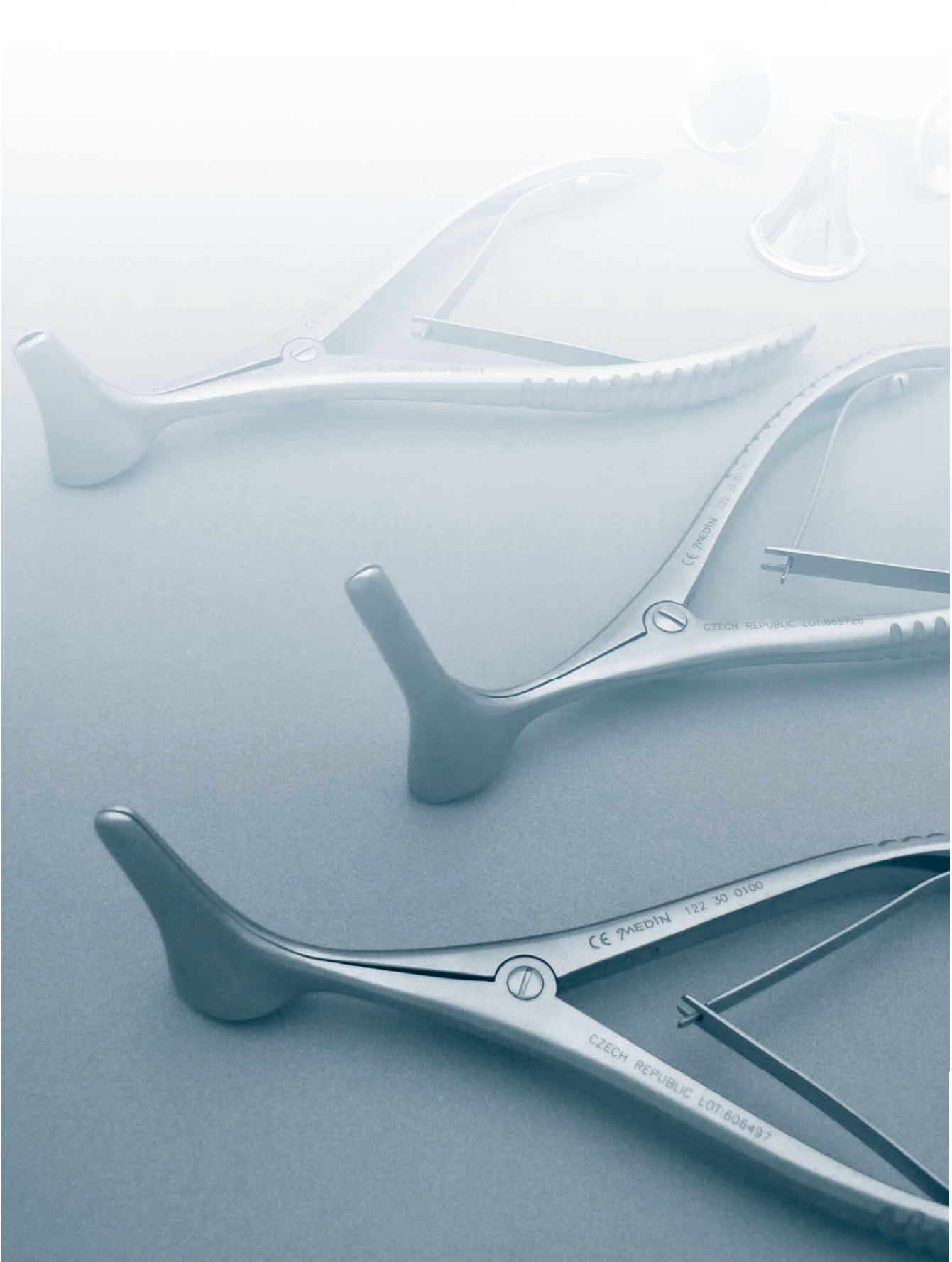

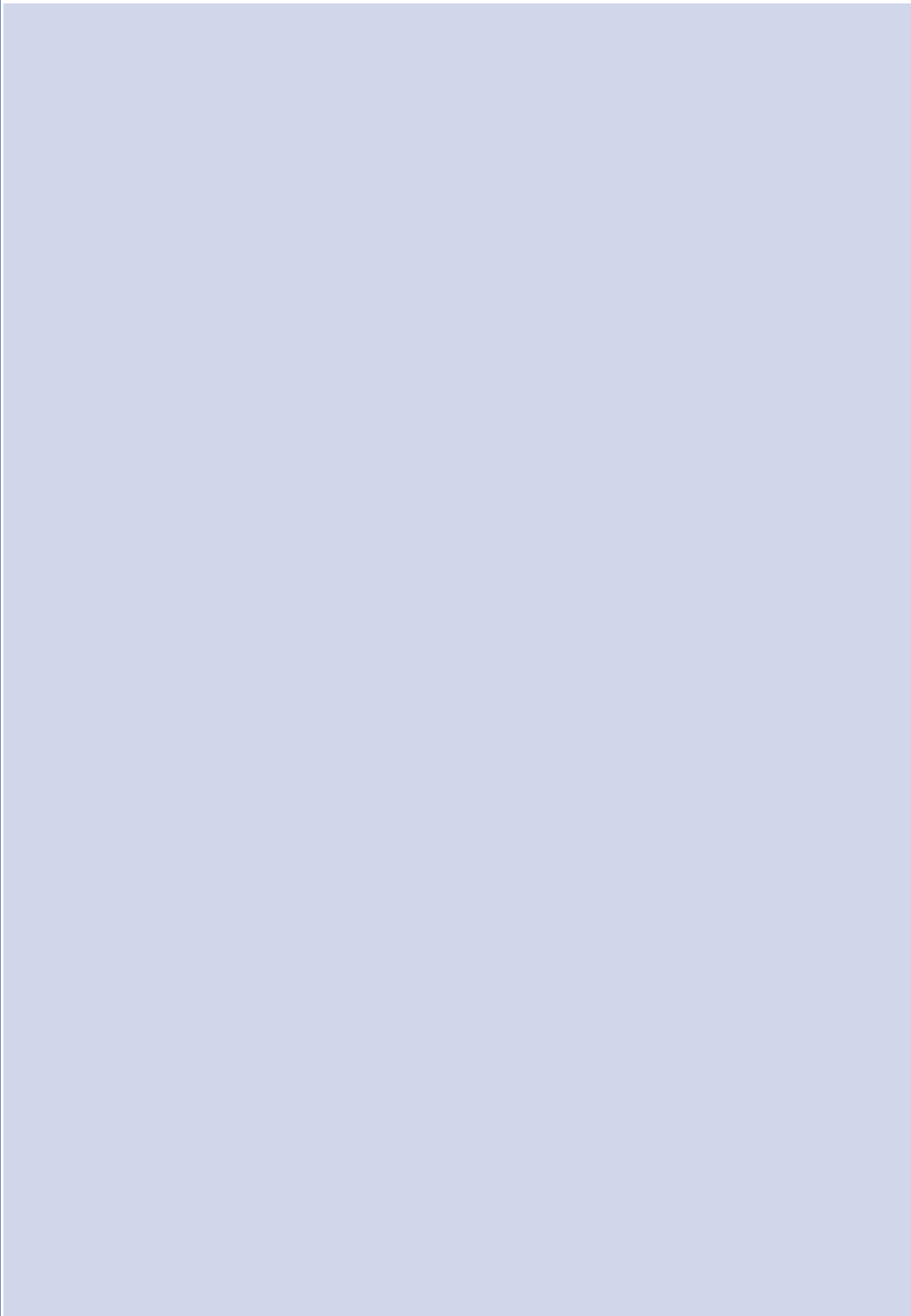

2 mm

3 mm

3,5 mm

4 mm

5 mm

6,5 mm

7 mm

7,5 mm

POLITZER

122 91 0200 – Fig. 1 – 3
sada – set

122 91 0201 – Fig. 1
2 mm

122 91 0202 – Fig. 2
3 mm

122 91 0203 – Fig. 3
4 mm

122 91 0204 – Fig. 4
5 mm

HARTMANN

122 91 0205 – Fig. 0 – 2
sada – set

122 91 0206 – Fig. 0
2 mm

122 91 0207 – Fig. 1
3,5 mm

122 91 0208 – Fig. 2
5 mm

HARTMANN

122 91 0217 – Fig. 0 – 3
sada – set

122 91 0213 – Fig. 0
3 mm

122 91 0214 – Fig. 1
4 mm

122 91 0215 – Fig. 2
5 mm

122 91 0216 – Fig. 3
7 mm

HARTMANN

122 91 0212 – Fig. 1 – 4
sada – set

122 91 0207 – Fig. 1
3,5 mm

122 91 0208 – Fig. 2
5 mm

122 91 0209 – Fig. 3
6,5 mm

122 91 0210 – Fig. 4
7,5 mm

HARTMANN

122 91 0211 – Fig. 2 – 4
sada – set

122 91 0208 – Fig. 2
5 mm

122 91 0209 – Fig. 3
6,5 mm

122 91 0210 – Fig. 4
7,5 mm

TOYNBEE

122 91 0219 – Fig. 1 – 4
sada – set

122 91 0220 – Fig. 1
3 mm

122 91 0221 – Fig. 2
4 mm

122 91 0222 – Fig. 3
5 mm

122 91 0223 – Fig. 4
6,5 mm

TOYNBEE

122 91 0218 – Fig. 2 – 4
sada – set



122 91 0221 – Fig. 2
4 mm

122 91 0222 – Fig. 3
5 mm

122 91 0223 – Fig. 4
6,5 mm

**GRUBER**

122 91 0224 – Fig. 1 – 4
sada – set







-  **122 91 0225** – Fig. 1
4,5 mm
-  **122 91 0226** – Fig. 2
5,5 mm
-  **122 91 0227** – Fig. 3
6,5 mm
-  **122 91 0228** – Fig. 4
7,0 mm



hliníkové černé
alu black

ZÖLLNER

122 91 0229 – Fig. 1 – 6
sada – set

-  **122 91 0230** – Fig. 1
5,5 × 6,5 mm
-  **122 91 0231** – Fig. 2
6,5 × 7,5 mm
-  **122 91 0232** – Fig. 3
7,5 × 8,5 mm
-  **122 91 0233** – Fig. 4
8,5 × 9,5 mm
-  **122 91 0234** – Fig. 5
9,5 × 10,5 mm
-  **122 91 0235** – Fig. 6
10,5 × 11,5 mm

**BOUCHERON**

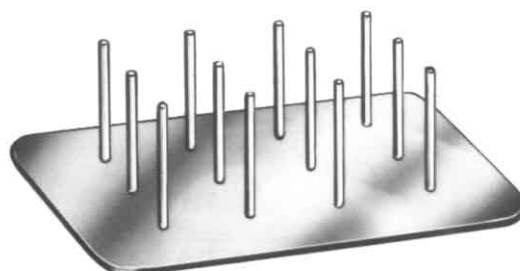

122 91 0236 – Fig. 1 – 4
sada – set

-  **122 91 0237** – Fig. 1
3,5 mm
-  **122 91 0238** – Fig. 2
4,5 mm
-  **122 91 0239** – Fig. 3
5,5 mm
-  **122 91 0240** – Fig. 4
6,5 mm

**DRŽÁK KOVOVÝ
METAL HANDLE****119 91 0287**

pro 12 ušních zrcátek
for 12 specula



	FARRIOR 122 91 0241 3,3 mm		3,0 × 4,0 mm	FARRIOR 122 91 0250	FARRIOR 122 91 0259	FARRIOR 122 91 0268
	122 91 0242 4,3 mm		4,0 × 5,0 mm	122 91 0251	122 91 0260	122 91 0269
	122 91 0243 4,8 mm		4,5 × 5,5 mm	122 91 0252	122 91 0261	122 91 0270
	122 91 0244 5,3 mm		5,0 × 6,0 mm	122 91 0253	122 91 0262	122 91 0271
	122 91 0245 5,8 mm		5,5 × 6,5 mm	122 91 0254	122 91 0263	122 91 0272
	122 91 0246 6,3 mm		6,0 × 7,0 mm	122 91 0255	122 91 0264	122 91 0273
	122 91 0247 6,7 mm		6,5 × 7,5 mm	122 91 0256	122 91 0265	122 91 0274
	122 91 0248 7,2 mm		7,0 × 8,0 mm	122 91 0257	122 91 0266	122 91 0275
	122 91 0249 7,7 mm		7,5 × 8,5 mm	122 91 0258	122 91 0267	122 91 0276

**BRUENINGS****122 91 0277**komplet 4 zrcátka Fig. 0 – 3
complete with 4 specula Fig. 0 – 3
 **122 91 0278** – Fig. 00
2/4 mm

 **122 91 0279** – Fig. 0
3/4,8 mm

 **122 91 0280** – Fig. 1
4/6 mm

 **122 91 0281** – Fig. 2
5/7 mm

 **122 91 0282** – Fig. 3
6,5/8,5 mm

 **122 91 0283** – Fig. 4
8,5/10,5 mm

 **122 91 0284** – Fig. 5
10,5/12,5 mm
122 91 0285hlava sací se zvětšováním
suction head, only**122 91 0286**žárovka s trubičkou
rubertube and bulb, only**SIEGLE****122 91 0288**

komplet – complete

**122 91 0289**

5/6 mm

Fig. 1

**122 91 0290**

6/7 mm

Fig. 2

**122 91 0291**

7/8 mm

Fig. 3

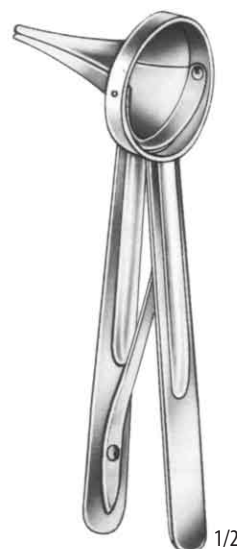
**RISHNAU HOLMGREN****122 91 0293****122 91 0294****122 91 0295**

průměr – diameter

2 mm

4 mm

6 mm



HARTMANN
122 30 0010

14,0 cm
Fig. 1



HARTMANN
122 30 0020

14,3 cm
Fig. 2



KILLIAN
122 30 0100

14,7 cm
Fig. 1



KILLIAN
122 30 0110

15,0 cm
Fig. 2



KILLIAN
122 30 0120

15,7 cm
Fig. 3

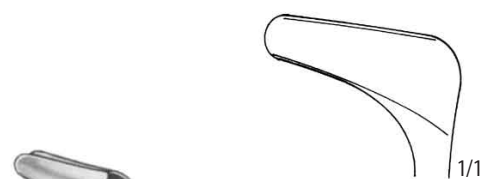

122 91 0296
Fig. 1

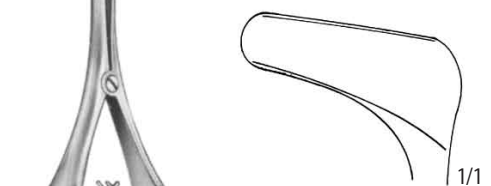

122 91 0298
Fig. 2

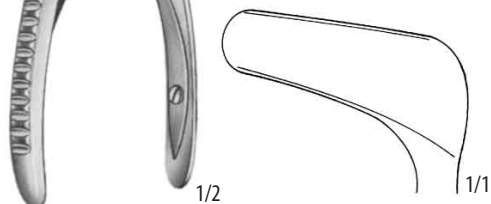

122 91 0300
Fig. 3

HARTMANN-HALLE
15,0 cm

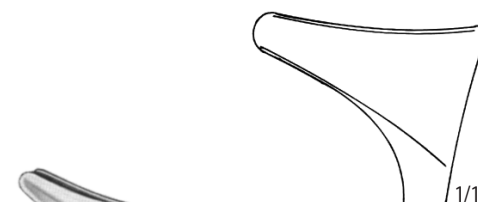

122 91 0302
Fig. 1

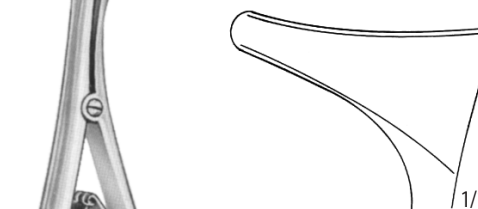

122 91 0304
Fig. 2

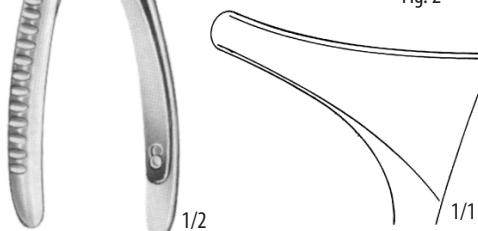

122 91 0306
Fig. 3

HARTMANN
15,0 cm



122 91 0308
Fig. 1



122 91 0310
Fig. 2

TIECK-HALLE
13,5 cm



122 91 0328
Fig. 1

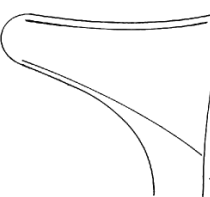

122 91 0330
Fig. 2

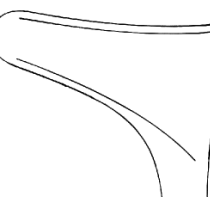

122 91 0332
Fig. 3

MOD. VIENNE
14,5 cm

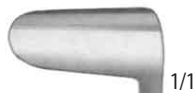

1/1

122 91 0350 – Fig. 1

122 91 0351 – Fig. 1
černé – black



1/1

122 91 0352 – Fig. 2

122 91 0353 – Fig. 2
černé – black



1/2

**THUDICHUM
(GOLDSMITH)**
6,5 cm



1/1

122 91 0354 – Fig. 3

122 91 0355 – Fig. 3
černé – black



1/2

**VOLTOLINI
(DUPLAY)**

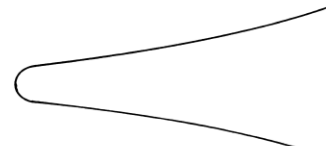

1/1

122 91 0356 – Fig. 1

122 91 0357 – Fig. 1
černé – black

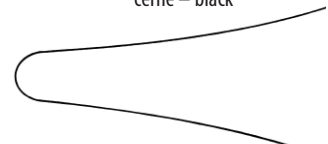

1/1

122 91 0358 – Fig. 2

122 91 0359 – Fig. 2
černé – black

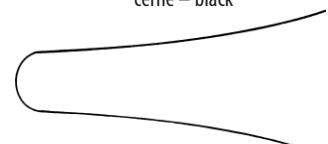

1/1

122 91 0360 – Fig. 3

122 91 0361 – Fig. 3
černé – black

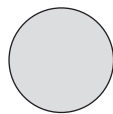
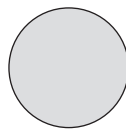
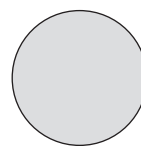
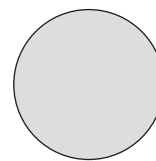
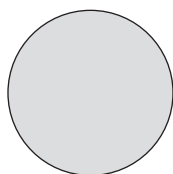
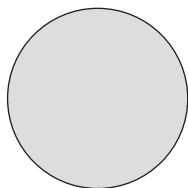
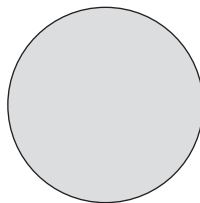
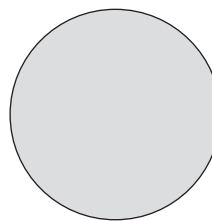
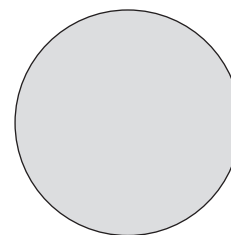
Fig. 00
8 mmFig. 0
10 mmFig. 1
12 mmFig. 2
14 mmFig. 3
16 mmFig. 4
18 mmFig. 5
20 mmFig. 6
22 mmFig. 7
24 mmFig. 8
26 mmFig. 9
28 mmFig. 10
30 mm

1/2



1/2



1/2

DRŽADLO HRTANOVÝCH ZRCÁTEK
HANDLE
122 91 0172
10,0 cm

Fig. 00	122 91 0173	Fig. 00	122 91 0185
Fig. 0	122 91 0174	Fig. 0	122 91 0186
Fig. 1	122 91 0175	Fig. 1	122 91 0187
Fig. 2	122 91 0176	Fig. 2	122 91 0188
Fig. 3	122 91 0177	Fig. 3	122 91 0189
Fig. 4	122 91 0178	Fig. 4	122 91 0190
Fig. 5	122 91 0179	Fig. 5	122 91 0191
Fig. 6	122 91 0180	Fig. 6	122 91 0192
Fig. 7	122 91 0181	Fig. 7	122 91 0193
Fig. 8	122 91 0182	Fig. 8	122 91 0194
Fig. 9	122 91 0183	Fig. 9	122 91 0195
Fig. 10	122 91 0184	Fig. 10	122 91 0196

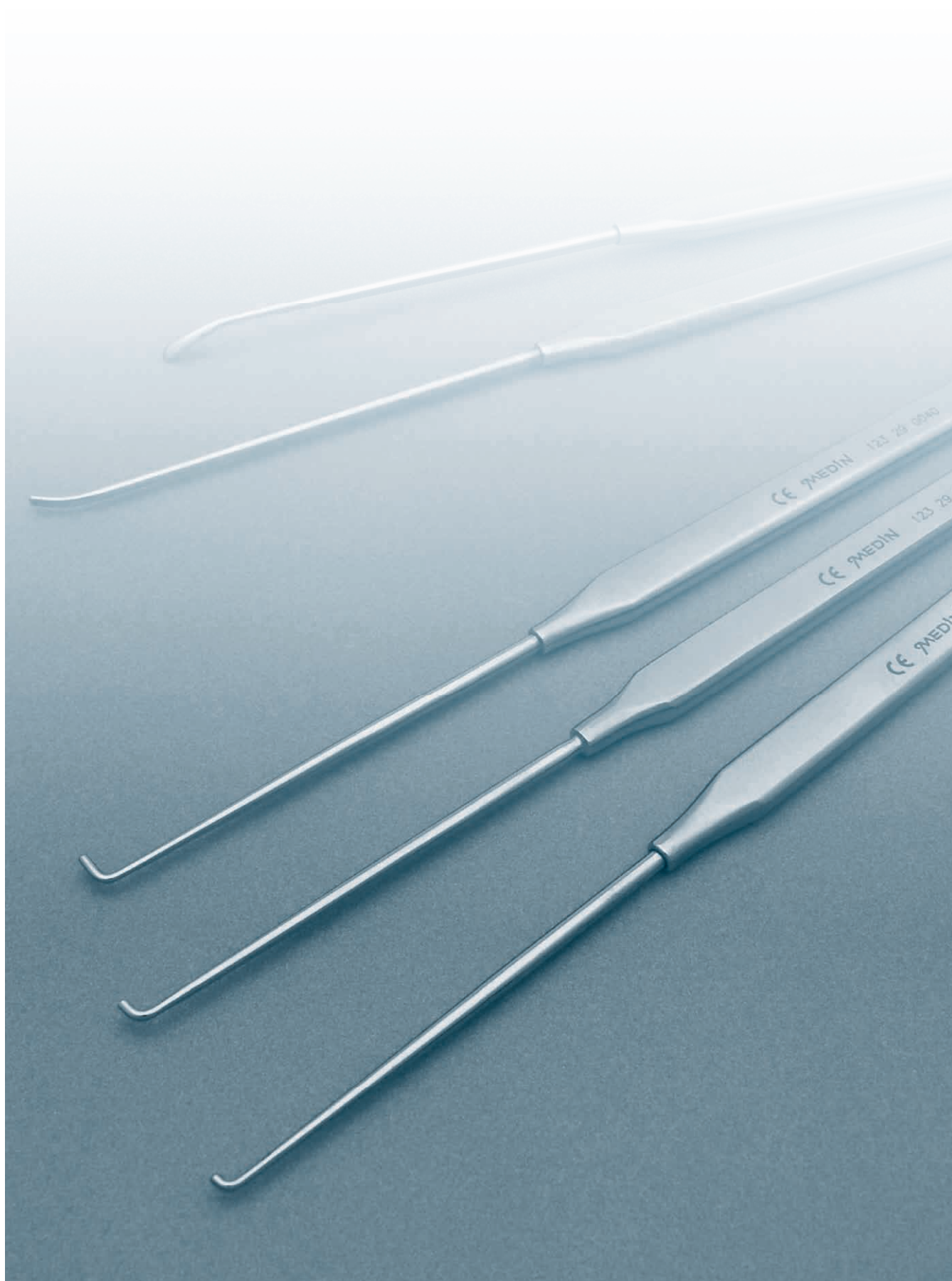



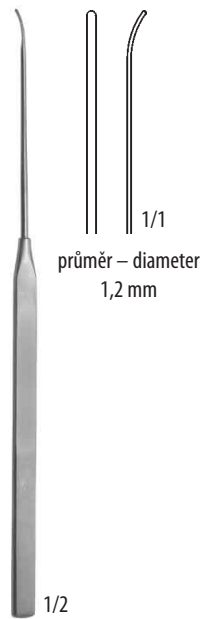

123 29 0010
16,0 cm



LUCAE
123 29 0020
15,0 cm

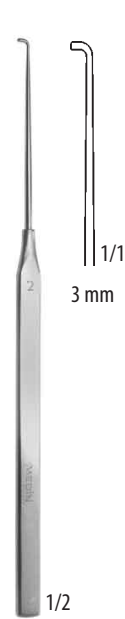

LUCAE
123 29 0030
15,0 cm

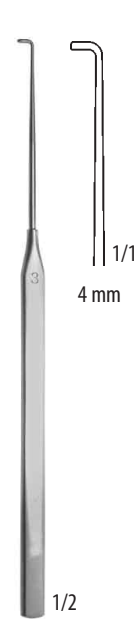

LUCAE
123 29 0040
15,0 cm

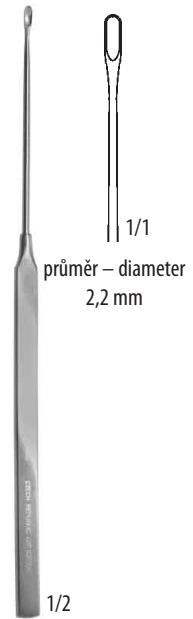

LUCAE
123 29 0080
16,0 cm



SHAMBAUGH-DERLACKI
123 91 0021
16,5 cm



LEMPERT
17,0 cm



123 91 0022
2 mm



123 91 0023
3 mm



123 91 0024
4 mm



123 91 0025
5 mm

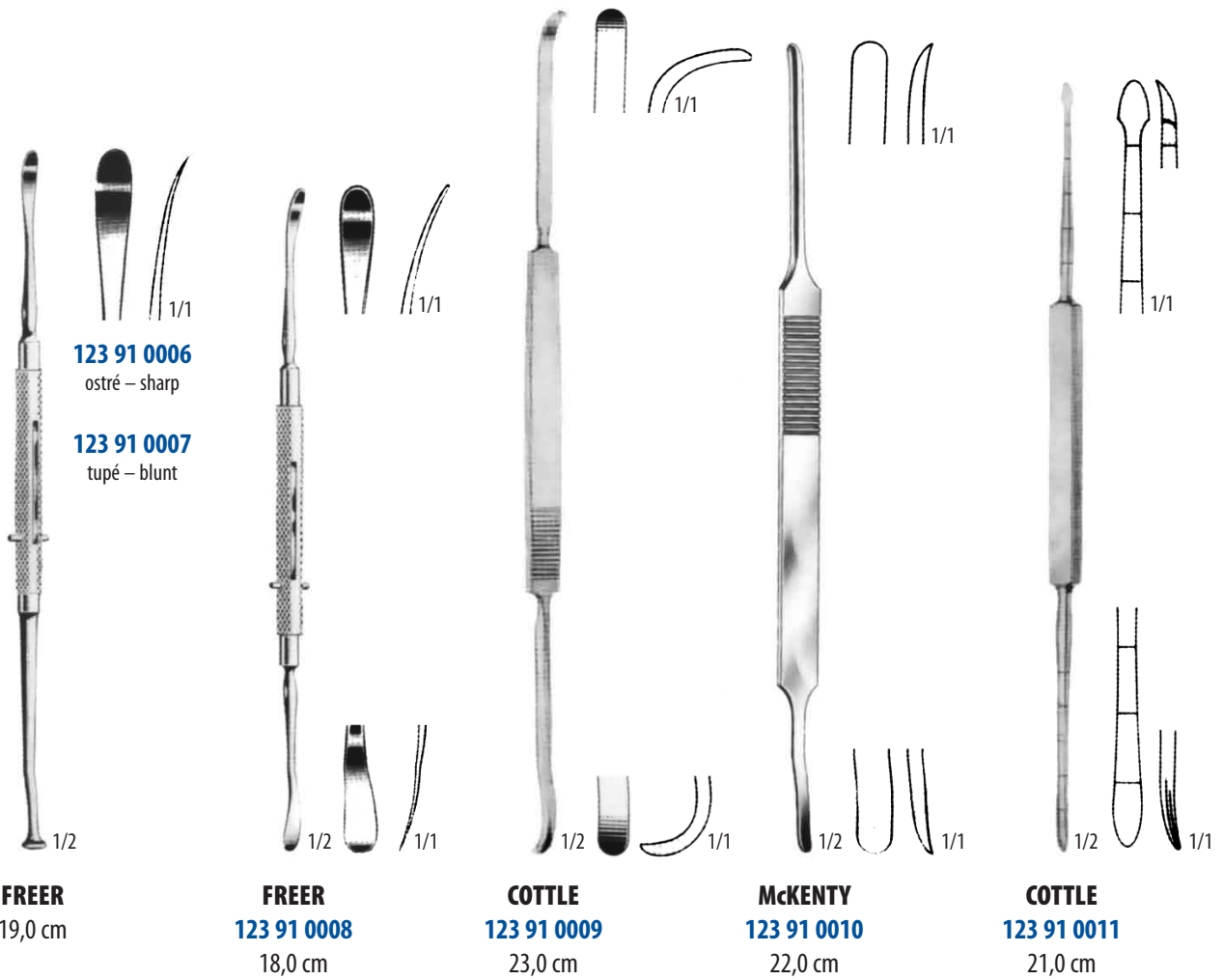



MASING
123 91 0012
21,0 cm



HOWARTH
123 91 0013
21,5 cm



KILLIAN
123 91 0014
18,0 cm



KILLIAN
123 91 0015
22,0 cm

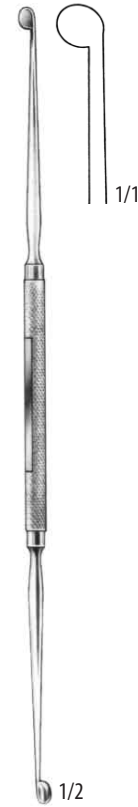

PIERCE
123 91 0016
21,0 cm

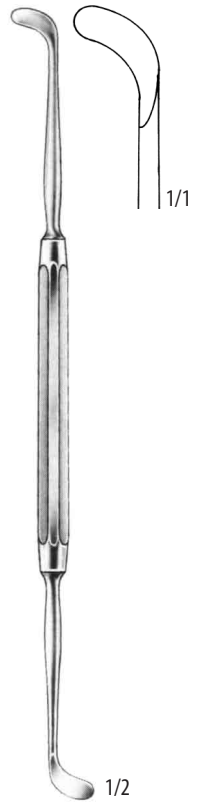

PENNINGTON
123 91 0017
21,0 cm

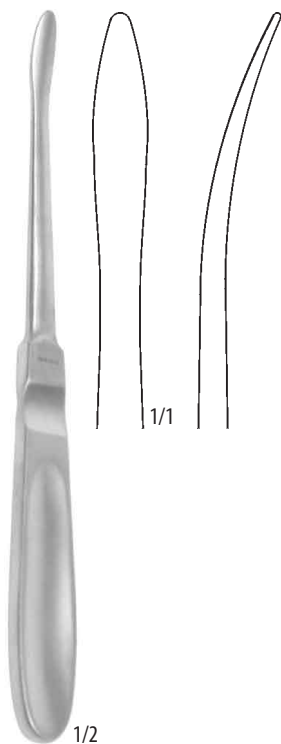

LANGENBECK
123 08 0010
19,5 cm

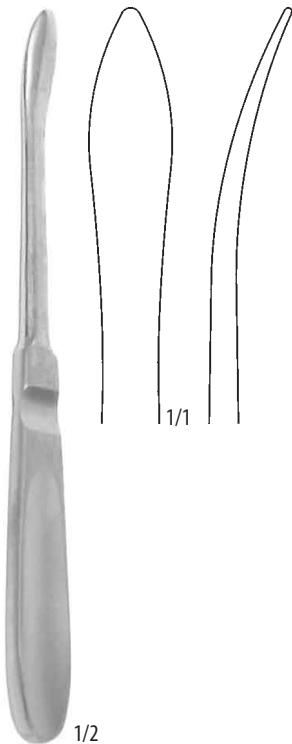

LANGENBECK
123 08 0020
19,5 cm

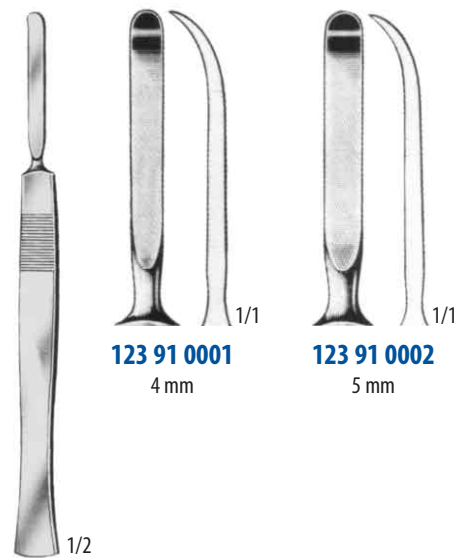

McKENTY
14,5 cm

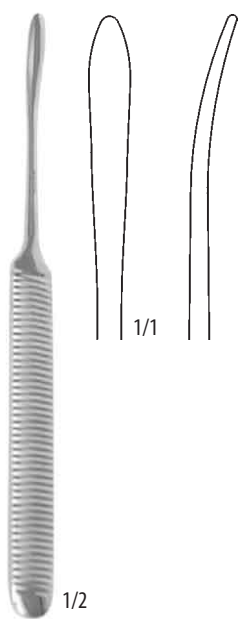

WILLIGER
123 08 0030
16,0 cm

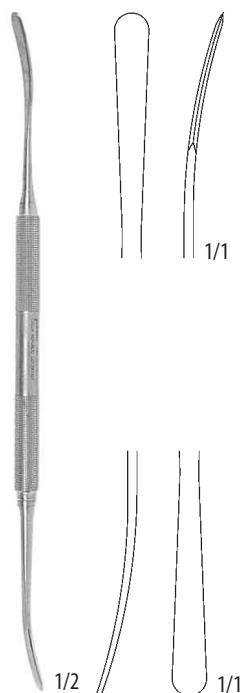

FREER
123 30 0030
17,9 cm



JOSEPH-MASING
123 91 0003
22,0 cm



HALLE
123 91 0004
16,5 cm



JOSEPH
123 91 0005
16,0 cm

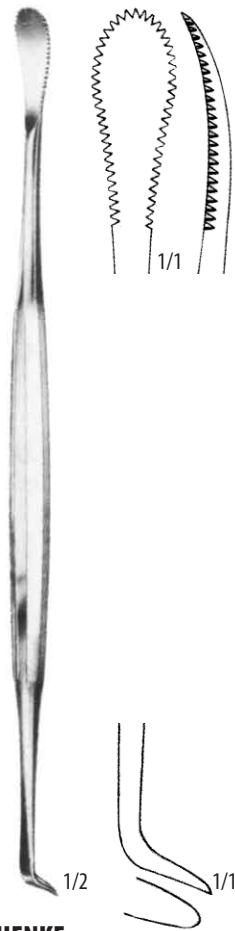

HENKE
123 91 0018
23,0 cm

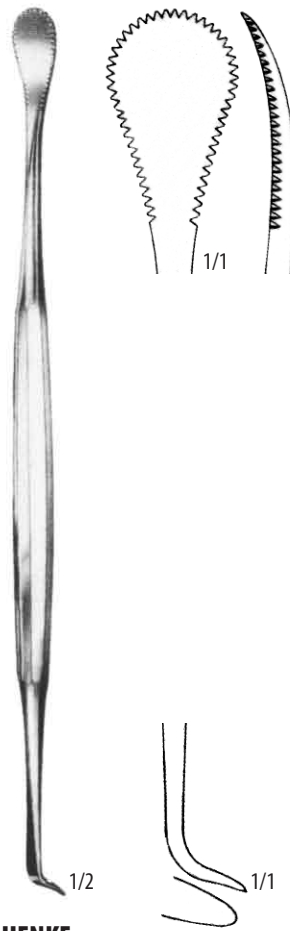

HENKE
123 91 0019
23,0 cm

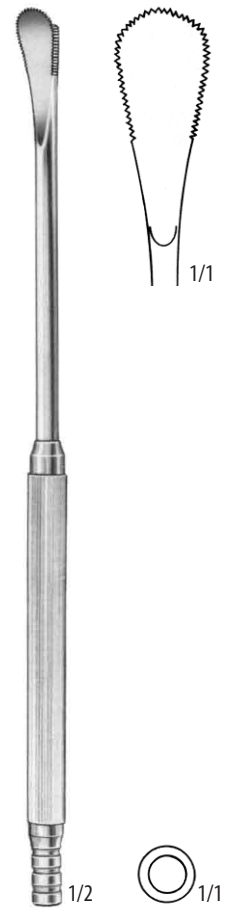

LOPEZ-REINKE
123 91 0020
23,5 cm

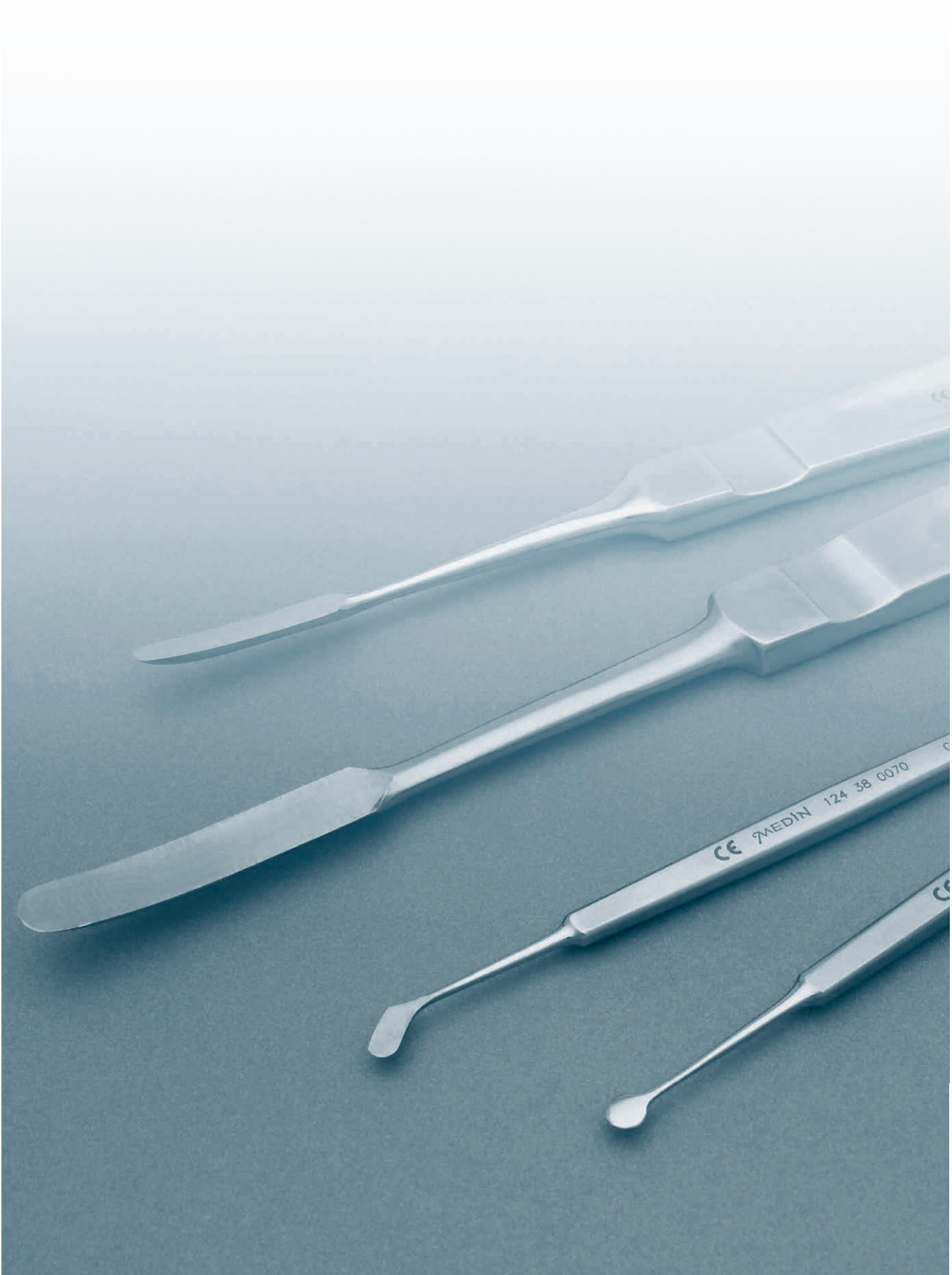





ROSEN
19,0 cm



ROSEN
16,0 cm

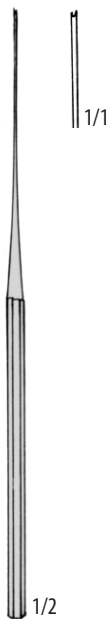
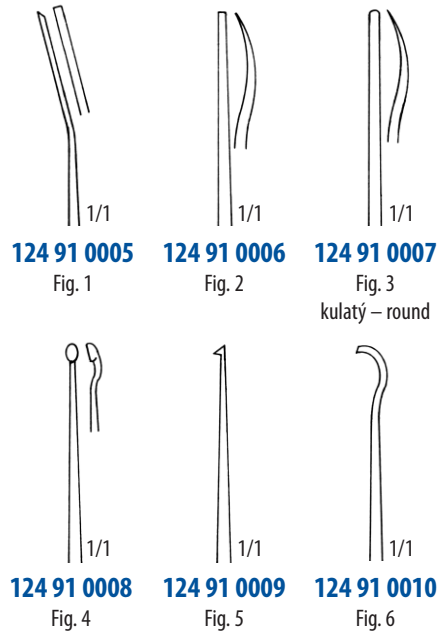

PLESTER
124 91 0011
16,0 cm



WULLSTEIN
16,0 cm



LEMPERT
124 91 0014
16,0 cm

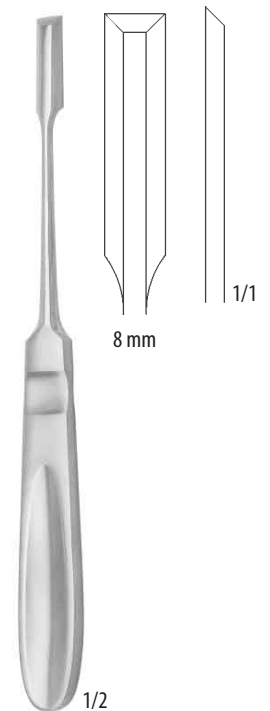

HARTMANN
124 29 0010
18,5 cm



WILLIGER
16,0 cm

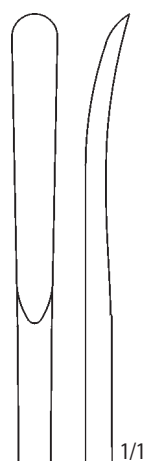

124 08 0111
16,0 cm
6 mm
matovaná – matt



124 08 0280
16,0 cm
3,5 mm
matovaná – matt



124 08 0290
16,0 cm
3,5 mm
matovaná – matt

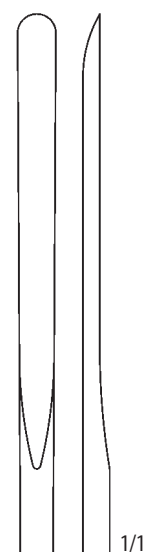

124 08 0250
18,0 cm
5 mm
matovaná – matt

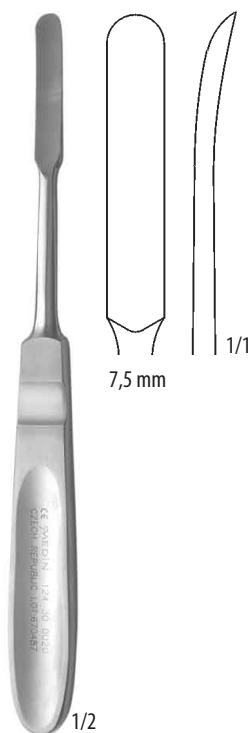
ŠKRABKY NOSNÍ, NA MANDLE
NASAL, TONSIL RASPATORIES

PŘEČHTĚL
124 30 0020
19,0 cm

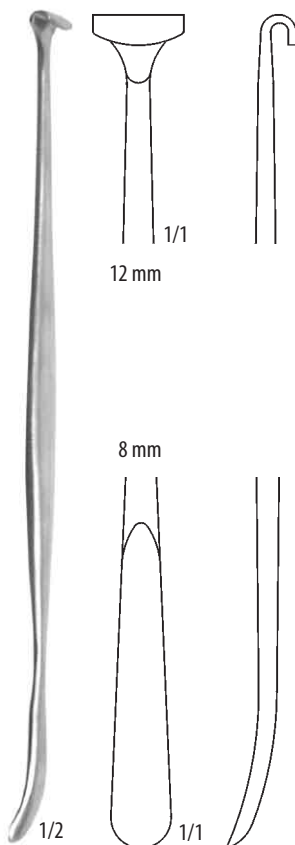

HURD
124 32 0010
21,0 cm



HURD
22,5 cm

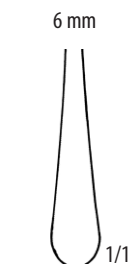

124 91 0001



124 91 0002







1/2

HALLE
125 30 0110
23,0 cm



1/1

125 30 0100
6 × 4 mm



1/1

125 30 0110
9 × 5 mm



1/2

BARTH
125 91 0019
18,0 cm



1/2



1/1

JANSEN
125 91 0020
15,0 cm

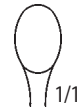
**125 08 0110**17,0 cm
Fig. 000
3,5 mm**125 08 0120**17,2 cm
Fig. 0
4,8 mm**125 08 0130**17,5 cm
Fig. 1
6 mm**125 08 0160**16,5 cm
Fig. 1
3 mm**125 08 0170**16,5 cm
Fig. 2
3,5 mm**125 08 0180**17,5 cm
Fig. 3
4 mm**125 08 0190**19,5 cm
Fig. 5
5 mm**125 08 0200**19,5 cm
Fig. 6
6,7 mm

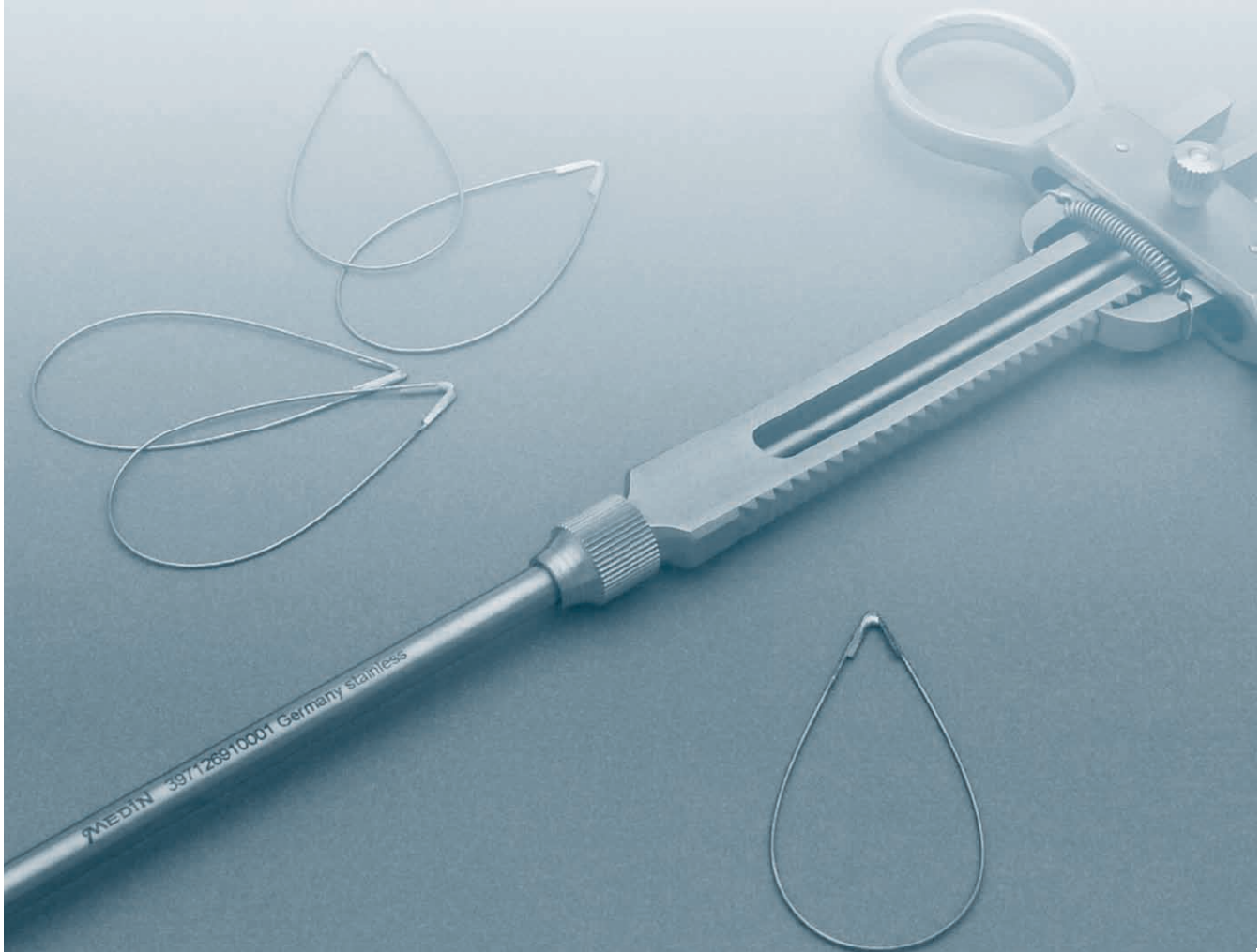



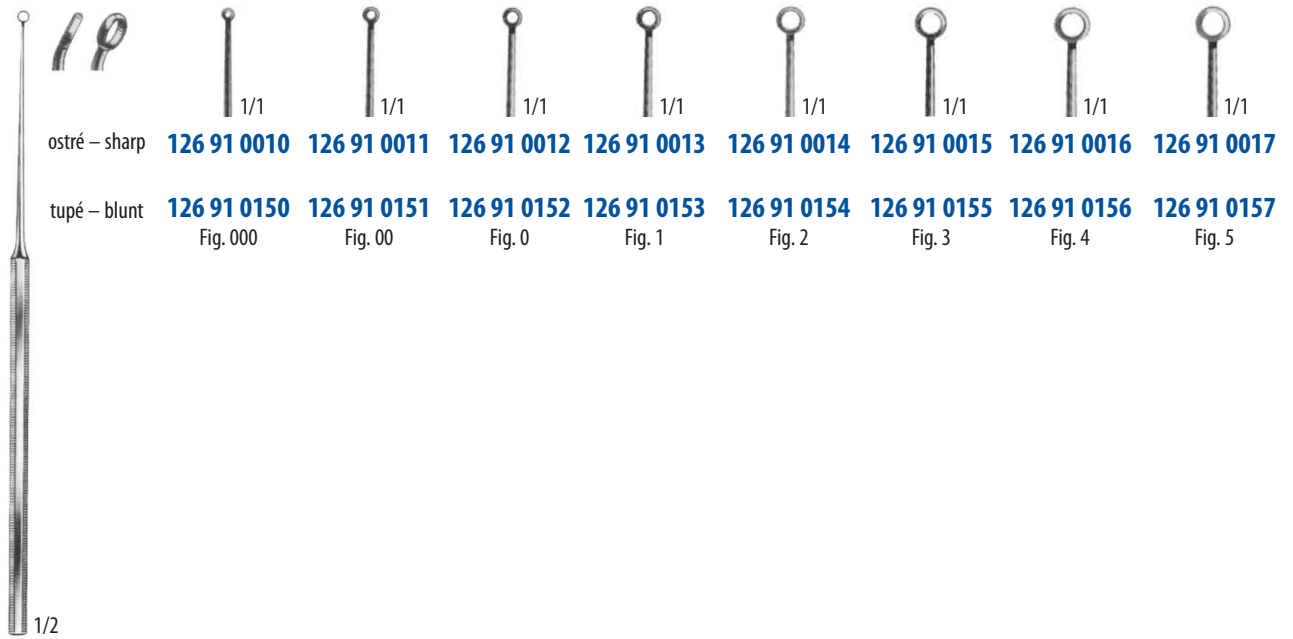

ostré – sharp

126 91 0010
126 91 0011
126 91 0012
126 91 0013
126 91 0014
126 91 0015
126 91 0016
126 91 0017

tupé – blunt

126 91 0150
126 91 0151
126 91 0152
126 91 0153
126 91 0154
126 91 0155
126 91 0156
126 91 0157

Fig. 000

Fig. 00

Fig. 0

Fig. 1

Fig. 2

Fig. 3

Fig. 4

Fig. 5

1/2

BUCK

16,5 cm



1/2

SHAPLEIGH

13,0 cm



1/1

126 91 0018

Fig. 1



1/1

126 91 0019

Fig. 2



1/2

LANGENBECK
126 91 0020

13,0 cm



1/1



1/1



1/1
126 91 0125
1,0 + 1,2 mm
126 91 0126
1,5 + 1,8 mm

HOUSE
15,0 cm



1/1
126 91 0127
1,0 + 1,2 mm
126 91 0128
1,5 + 1,8 mm

HOUSE
15,0 cm

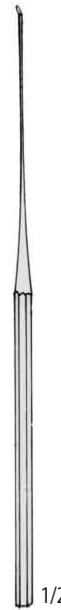

1/1
1,5 × 2,5 mm

SHEA
126 91 0129
16,0 cm



1/1
1,5 × 2,5 mm

SHEA
126 91 0130
lomená – angled
16,0 cm



LEMPERT
21,0 cm

1/1
126 91 0131
Fig. 0

1/1
126 91 0132
Fig. 00

1/1
126 91 0133
Fig. 000

1/1
126 91 0134
Fig. 0000

1/1
126 91 0135
Fig. 00000



KRAUSE
126 91 0110
 16,0 cm



KRAUSE-VOSS
126 91 0111
 16,0 cm

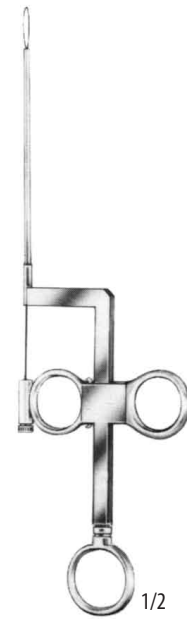

LANGE-WILDE
126 91 0112
 16,0 cm



126 91 0113 0,3 mm
126 91 0114 0,4 mm
 délka – length
 10 m



126 91 0115 0,2 mm
126 91 0116 0,3 mm
 Balení po 12 ks.
 Pack of 12 pcs.

126 91 0117 0,2 mm
126 91 0118 0,3 mm
 Balení po 100 ks.
 Pack of 100 pcs.



BILLEAU
16,5 cm



126 91 0119
Fig. 1



126 91 0120
Fig. 2



126 91 0121
Fig. 3



SNELLEN
16,5 cm



126 91 0122
Fig. 1



126 91 0123
Fig. 2



GROSS
126 91 0124
12,0 cm

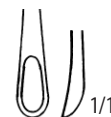

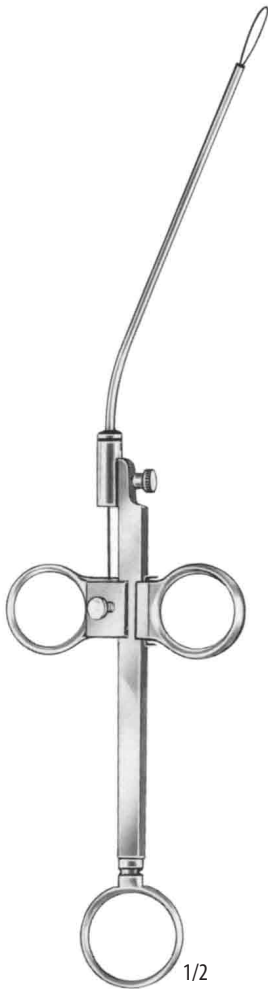

KRAUSE
126 91 0136
26,0 cm

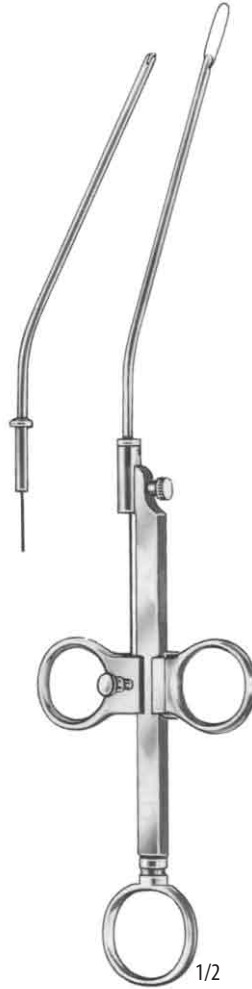

KRAUSE-VOSS
126 91 0137
26,0 cm

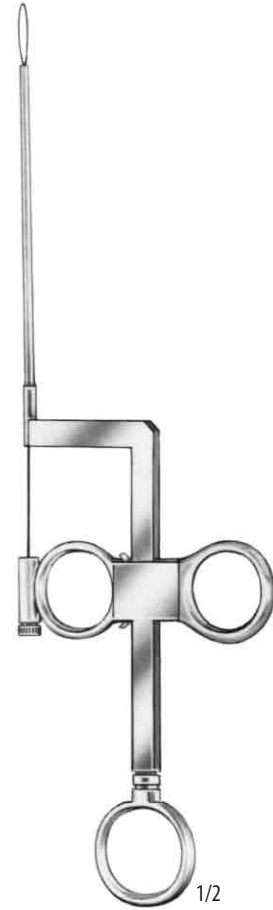

LANGE-WILDE
126 91 0138
24,0 cm



126 91 0140 0,3 mm
126 91 0141 0,4 mm
délka – length
10 m



126 91 0139
Balení po 12 ks.
Pack of 12 pcs.



COAKLEY
ostrá – sharp
17,0 cm



1/1
126 91 0142
Fig. 1



1/1
126 91 0143
Fig. 2



1/1
126 91 0144
Fig. 3



1/1
126 91 0145
Fig. 4



1/1
126 91 0146
Fig. 5



1/1
126 91 0147
Fig. 6

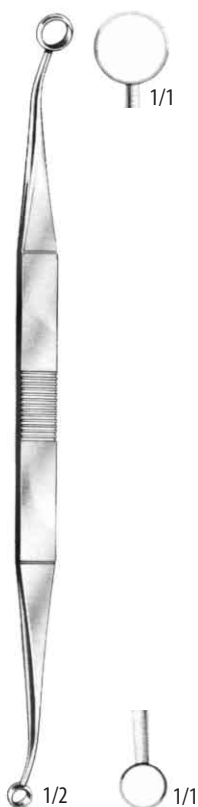

1/2
FAULKNER
126 91 0148
21,0 cm



1/1
SEWALL
126 91 0149
20,0 cm

**126 91 0103**

Fig. 1

**126 91 0104**

Fig. 2

**126 91 0105**

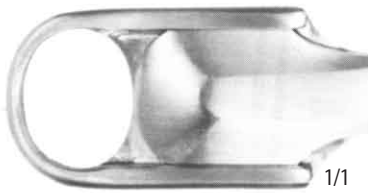
Fig. 3

**116 91 0101**

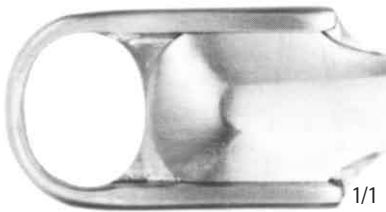
držadlo – handle only

SLUDER-BALLENGER**126 91 0102**

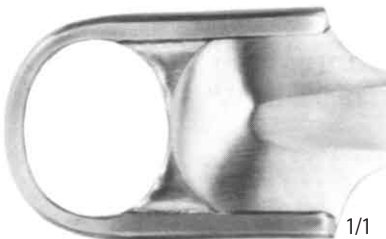
komplet – complete



BRUENINGS
126 91 0001
28,0 cm



EVES
126 91 0107
28,0 cm



EVES
126 91 0108
28,0 cm



126 32 0080
 4,8 cm
 průměr – diameter
 0,3 mm



126 32 0090
 4,8 cm
 průměr – diameter
 0,4 mm



126 32 0110
 4,8 cm
 průměr – diameter
 0,5 mm



126 32 0120
 4,0 cm
 průměr – diameter
 0,3 mm



126 32 0130
 4,0 cm
 průměr – diameter
 0,4 mm



126 32 0140
 4,0 cm
 průměr – diameter
 0,5 mm



126 32 0160
 4,5 cm
 průměr – diameter
 0,4 mm

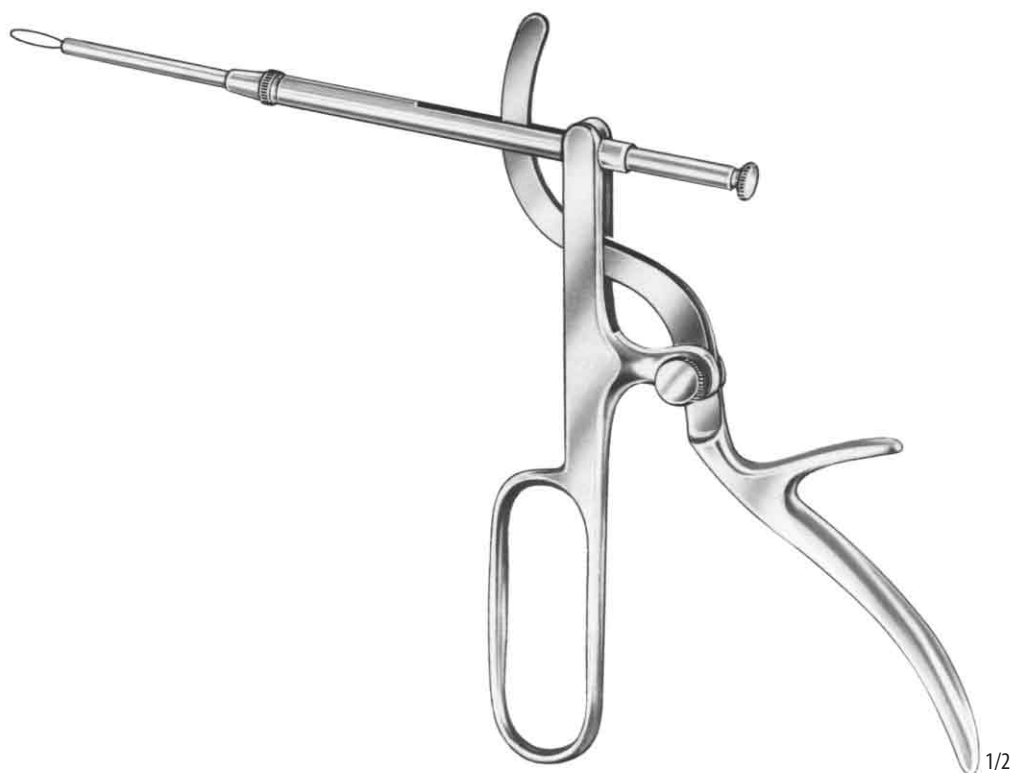

TYDING
126 91 0109



RÖDER
126 91 0100
26,5 cm

SMYČKY DRÁTĚNÉ NA MANDLE
WIRE LOOPS FOR TONSIL



126 91 0160
Balení po 12 ks.
Pack of 12 pcs.





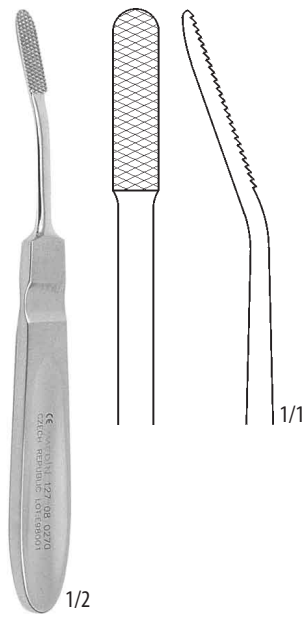

127 08 0270
15,9 cm

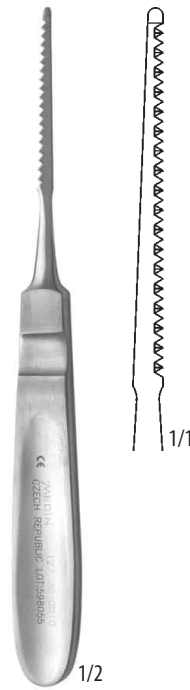

HOLBROOCK-CURTIS
127 30 0010
18,0 cm

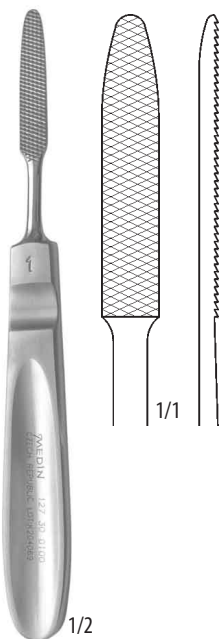

JOSEPH
127 30 0100
16,5 cm
Fig. 1

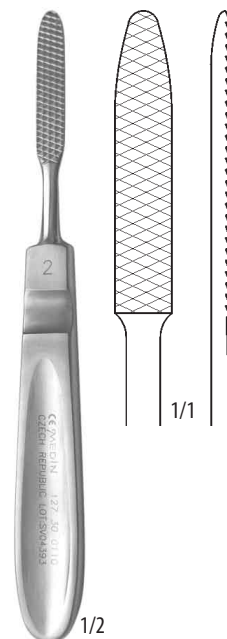

JOSEPH
127 30 0110
16,5 cm
Fig. 2

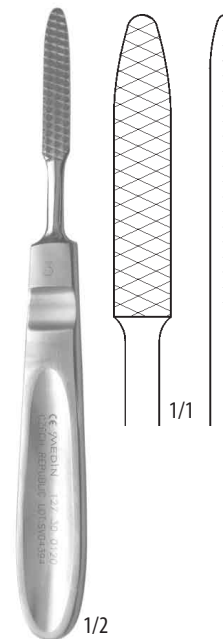

JOSEPH
127 30 0120
16,5 cm
Fig. 3

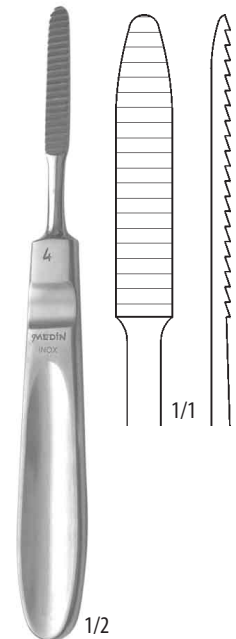

JOSEPH
127 30 0130
16,5 cm
Fig. 4

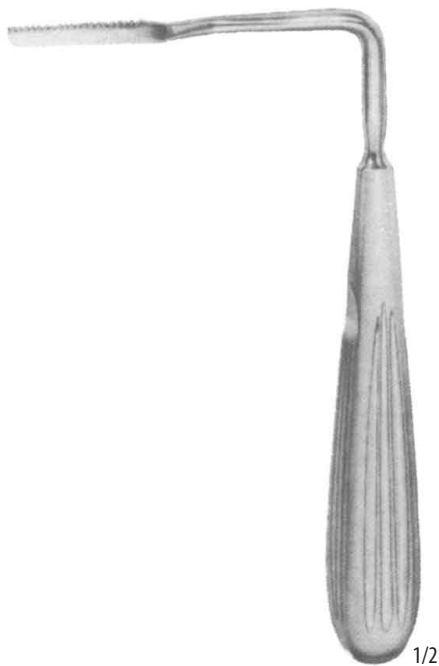

JOSEPH
127 91 0010
17,0 cm
levá – left



JOSEPH
127 91 0011
17,0 cm
pravá – right



JOSEPH
19,0 cm



127 91 0012
rovná – straight



127 91 0013
vyhnutá vlevo
angled on left



127 91 0014
vyhnutá vpravo
angled on right



LEWIS
18,0 cm

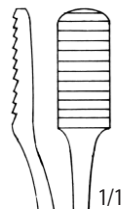

127 91 0015
Fig. 1

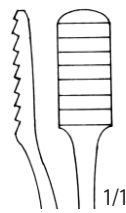

127 91 0016
Fig. 2

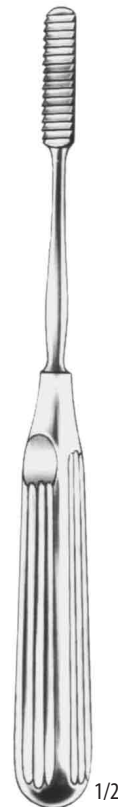

COTTLE
127 91 0017
21,0 cm

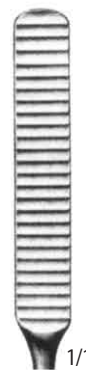

1/1



MALTZ
127 91 0020
18,0 cm

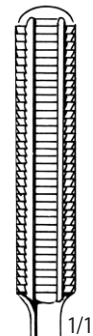

1/1



AUFRICHT
21,0 cm

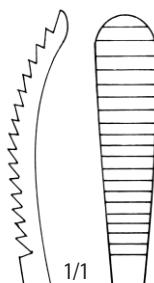

127 91 0018
Fig. 1

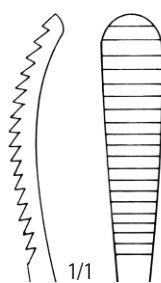

127 91 0019
Fig. 2



GALLAGHER
16,0 cm



1/1

127 91 0021
rovný – straight



1/1

127 91 0022
vyhnutý vlevo
curved on left



1/1

127 91 0023
vyhnutý vpravo
curved on right



WIENER
18,0 cm



127 91 0024
Fig. 1



127 91 0025
Fig. 2

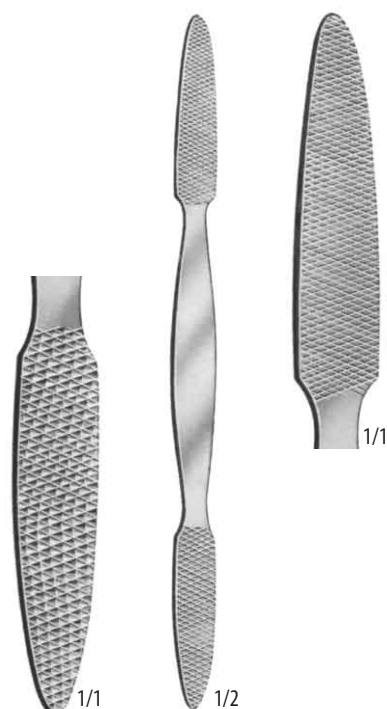

CONVERSE
127 91 0026
18,5 cm

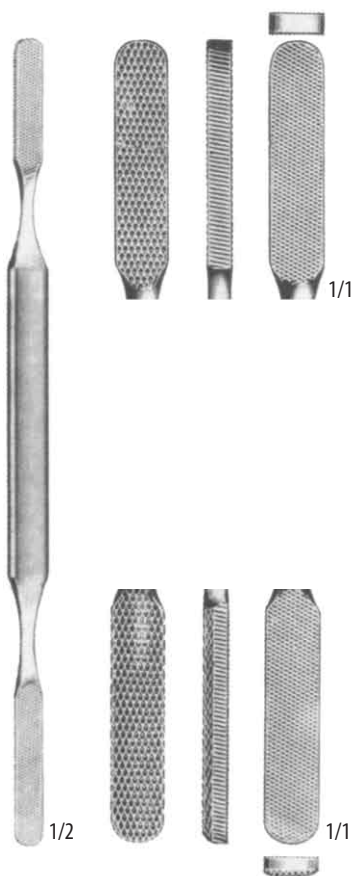

FOMON
127 91 0027
21,0 cm



MASING
127 91 0028
21,0 cm



MASING
127 91 0029
21,0 cm



1/2

MILLER-COLBURN
19,0 cm



1/1

127 91 0030
Fig. 1



1/1

127 91 0031
Fig. 2



1/1

127 91 0032
Fig. 3



1/1

127 91 0033
Fig. 4



1/1

127 91 0034
Fig. 5



1/1



1/1



1/1



1/1



1/1



1/2

MILLER-COLBURN
19,0 cm



1/1

127 91 0035
Fig. 1



1/1

127 91 0036
Fig. 2



1/1

127 91 0037
Fig. 3



1/1

127 91 0038
Fig. 4



1/1

127 91 0039
Fig. 5



1/1



1/1



1/1



1/1



1/1

PILNÍKY NOSNÍ TVRDOKOVÉ
NASAL RASPS TUC



COTTLE
127 91 0042
21,0 cm

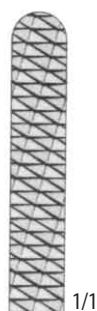

LEWIS
18,0 cm

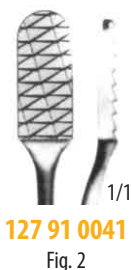
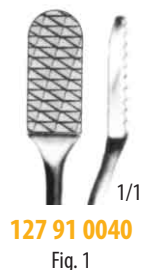

FOMON
20,0 cm







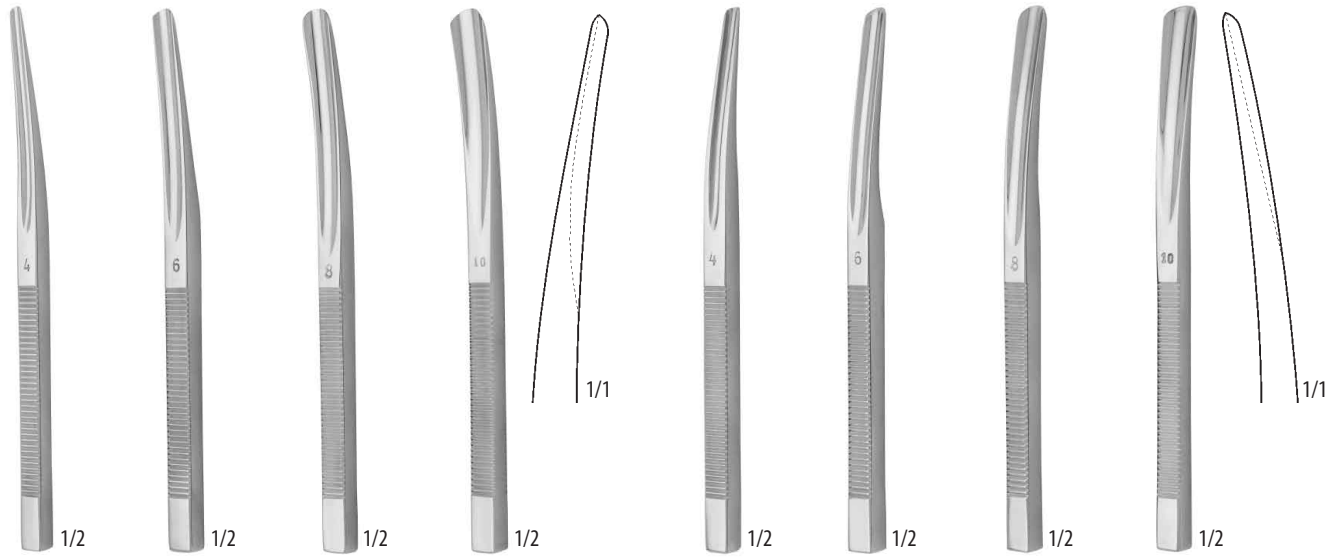

STACKE
128 29 0410
 14,0 cm
 4 mm

STACKE
128 29 0420
 14,0 cm
 6 mm

STACKE
128 29 0430
 14,0 cm
 8 mm

STACKE
128 29 0440
 14,0 cm
 10 mm

STACKE
128 29 0510
 14,0 cm
 4 mm

STACKE
128 29 0520
 14,0 cm
 6 mm

STACKE
128 29 0530
 14,0 cm
 8 mm

STACKE
128 29 0540
 14,0 cm
 10 mm

 CHRÁNIČ DLÁTEK
 CHISEL GUIDE

STACKE
128 29 0750
 15,0 cm

DLÁTA NA NOSNÍ PLASTIKU
NASAL PLASTIC CHISELS**128 12 0100**

19,0 cm

Fig. 1

**128 12 0110**

19,0 cm

Fig. 1

**128 12 0120**

rovné – straight

19,0 cm

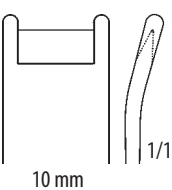
**128 12 0270**

vyhnuté – curved

19,0 cm

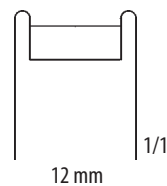
**128 12 0130**

rovné – straight

19,0 cm

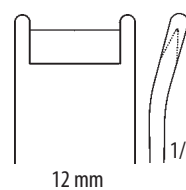
**128 12 0280**

vyhnuté – curved

19,0 cm

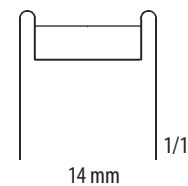
**128 12 0140**

rovné – straight

19,0 cm

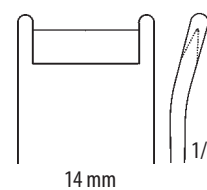
**128 12 0290**

vyhnuté – curved

19,0 cm

**128 12 0160**

18,0 cm

Fig. 2

**128 12 0170**

18,0 cm

Fig. 2

**128 12 0180**

18,0 cm

Fig. 2

**128 12 0190**

18,0 cm

Fig. 2



128 12 0500
15,5 cm

DLÁTA NOSNÍ
NASAL GOUGES

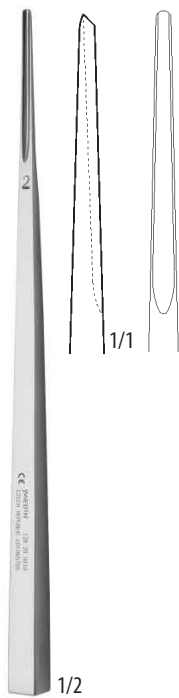

128 30 0010
18,0 cm
2 mm

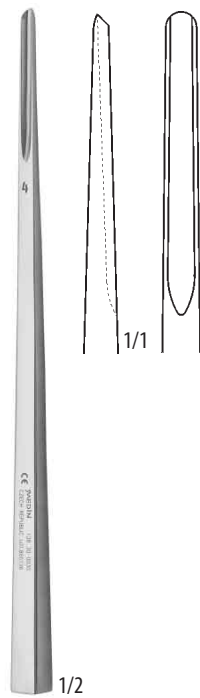

128 30 0030
18,0 cm
4 mm

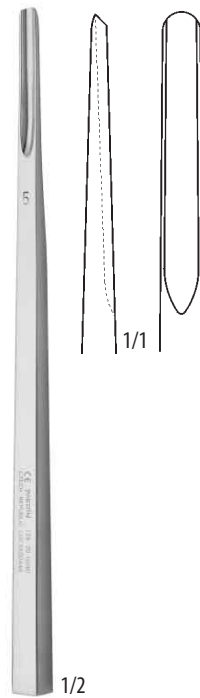

128 30 0040
18,0 cm
5 mm

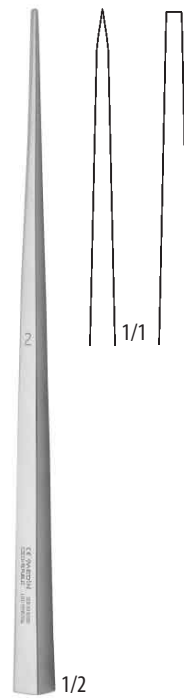

WEST
128 30 0200
18,0 cm
2 mm

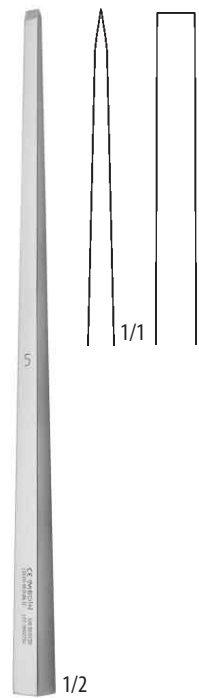

WEST
128 30 0230
18,0 cm
5 mm

DLÁTA NOSNÍ
NASAL CHISELS AND GOUGES

FREER
128 91 0160
16,0 cm



FREER
128 91 0161
16,0 cm



WEST
128 91 0162
16,0 cm



WEST
128 91 0163
16,0 cm



FREER
128 91 0164
15,0 cm



BALLENGER
128 91 0166
16,0 cm



KILLIAN
128 91 0168
16,0 cm



KILLIAN-CLAUS
128 91 0169
17,0 cm



 1/1
128 91 0170
4 mm

 1/1
128 91 0171
7 mm

 1/1
128 91 0172
9 mm

 1/1
128 91 0173
12 mm

COTTLE
18,0 cm

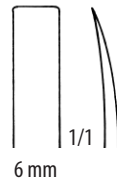

COTTLE
128 91 0174
18,0 cm

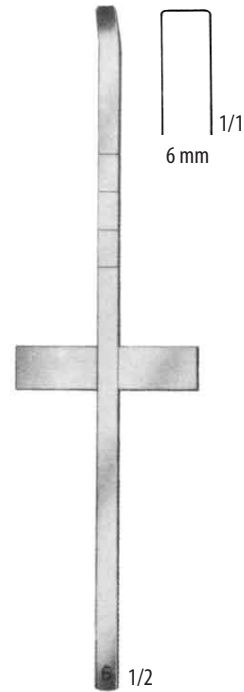

COTTLE
128 91 0175
18,0 cm

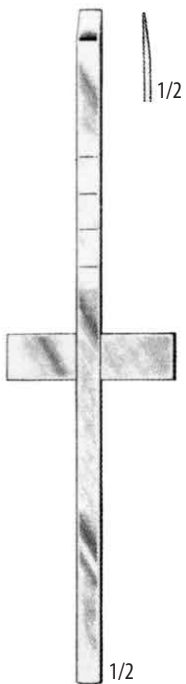

 1/1
128 91 0176
4 mm

 1/1
128 91 0177
7 mm

 1/1
128 91 0178
9 mm

 1/1
128 91 0179
12 mm

COTTLE
18,0 cm

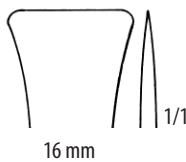

COTTLE
128 91 0180
18,0 cm

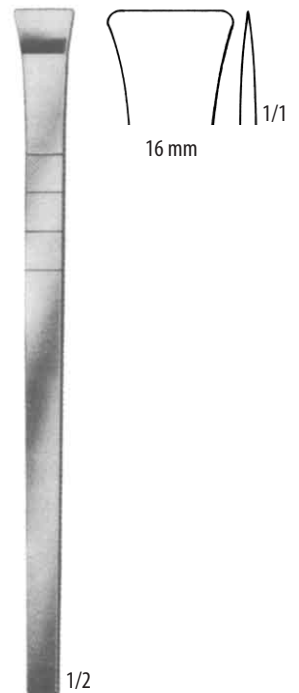

COTTLE
128 91 0181
18,0 cm

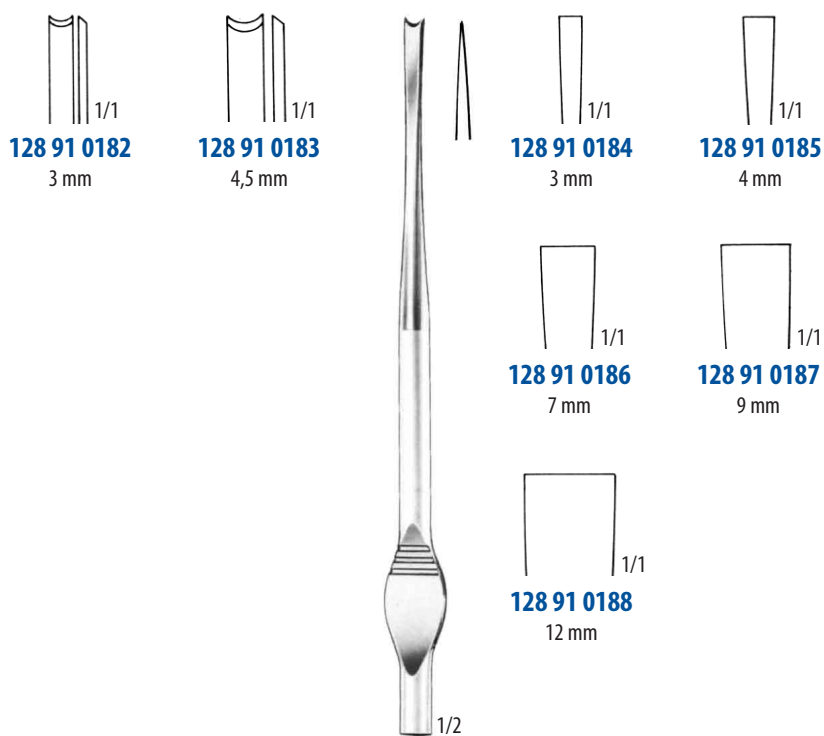
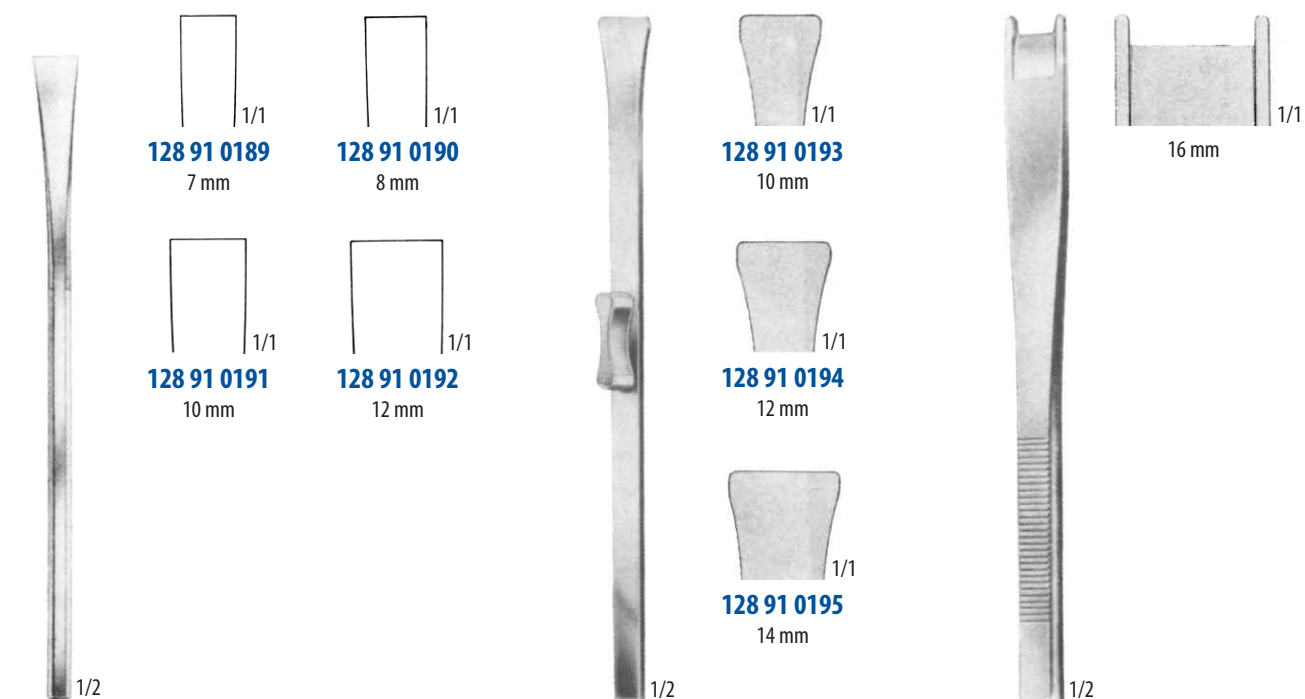
DLÁTA NOSNÍ
NASAL CHISELS**WALTER**
19,0 cm**SHEEHAN**
17,0 cm**RUBIN**
18,0 cm**CINELLI**
128 91 0196
18,0 cm

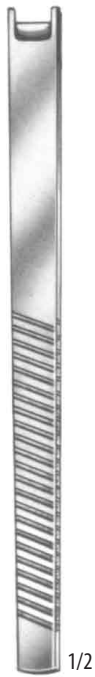

MASING
128 91 0197
 17,5 cm



MASING
128 91 0198
 17,5 cm
 rovné – straight



MASING
128 91 0199
 17,5 cm
 Fig. 1



MASING
128 91 0200
 17,5 cm
 Fig. 2

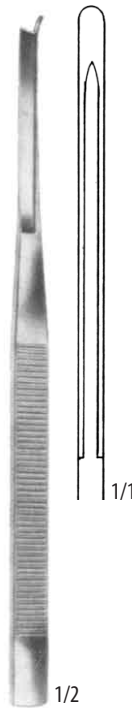

SILVER
128 91 0201
 18,0 cm
 rovné – straight

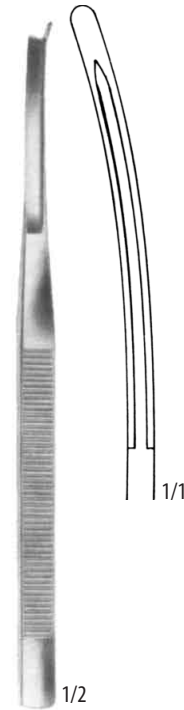

SILVER
128 91 0202
 18,0 cm
 Fig. 0

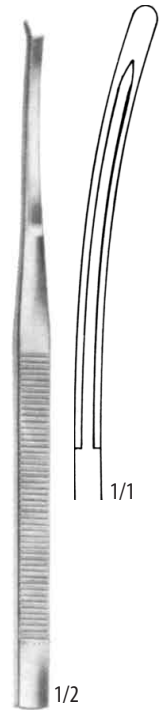

SILVER
128 91 0203
 18,0 cm
 Fig. 2



NEIVERT
128 91 0204
 20,0 cm
 rovné – straight



ANDERSON-NEIVERT
128 91 0205
 20,0 cm
 Fig. 1



128 91 0206
 20,0 cm
 Fig. 2



CONVERSE
128 91 0207
 19,0 cm
 Fig. 0

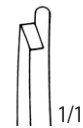

CONVERSE
128 91 0208
 19,0 cm
 Fig. 1

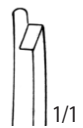

CONVERSE
128 91 0209
 19,0 cm
 Fig. 2

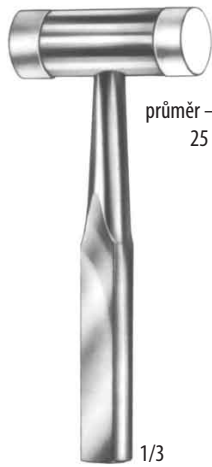

průměr – diameter
25 mm

1/3

128 91 0210

s vyměnitelnými koncovkami
with interchangeable discs

18,0 cm

140 g

128 91 0211

koncovky kovové, pár
ferrozell faces only, pair



průměr – diameter
30 mm

1/3

COTTLE

128 91 0212

19,0 cm

240 g



1/3

128 08 0911

23,5 cm

500 g



1/3

128 08 0901

22,0 cm

250 g



1/3

HAJEK

128 91 0159

22,0 cm

140 g







131 29 0010
 průměr – diameter
 3 mm
 průměr stopky
 diameter of shank
 2,35 mm
 Fig. 1

1/1

131 29 0020
 průměr – diameter
 3,5 mm
 průměr stopky
 diameter of shank
 2,35 mm
 Fig. 2

1/1

131 29 0030
 průměr – diameter
 4 mm
 průměr stopky
 diameter of shank
 2,35 mm
 Fig. 3

1/1

131 29 0040
 průměr – diameter
 4,5 mm
 průměr stopky
 diameter of shank
 2,35 mm
 Fig. 4

1/1

131 29 0050
 průměr – diameter
 5 mm
 průměr stopky
 diameter of shank
 2,35 mm
 Fig. 5

1/1

131 29 0050

131 29 0100
 průměr – diameter
 5 mm
 průměr stopky
 diameter of shank
 2,35 mm
 Fig. 1

1/1

131 29 0120
 průměr – diameter
 7 mm
 průměr stopky
 diameter of shank
 2,35 mm
 Fig. 3

1/1

131 29 0120

131 29 0200
 Fig. 1

1/1



průměr – diameter
 5 mm
 průměr stopky
 diameter of shank
 2,35 mm

1/1



131 29 0460

1/1

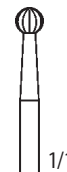

131 29 0450
 průměr – diameter
 2,7 mm
 průměr stopky
 diameter of shank
 2,35 mm
 Fig. 10

1/1



131 29 0460
 průměr – diameter
 3,1 mm
 průměr stopky
 diameter of shank
 2,35 mm
 Fig. 12

1/1

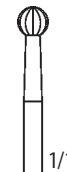

131 29 0470
 průměr – diameter
 3,5 mm
 průměr stopky
 diameter of shank
 2,35 mm
 Fig. 14

1/1

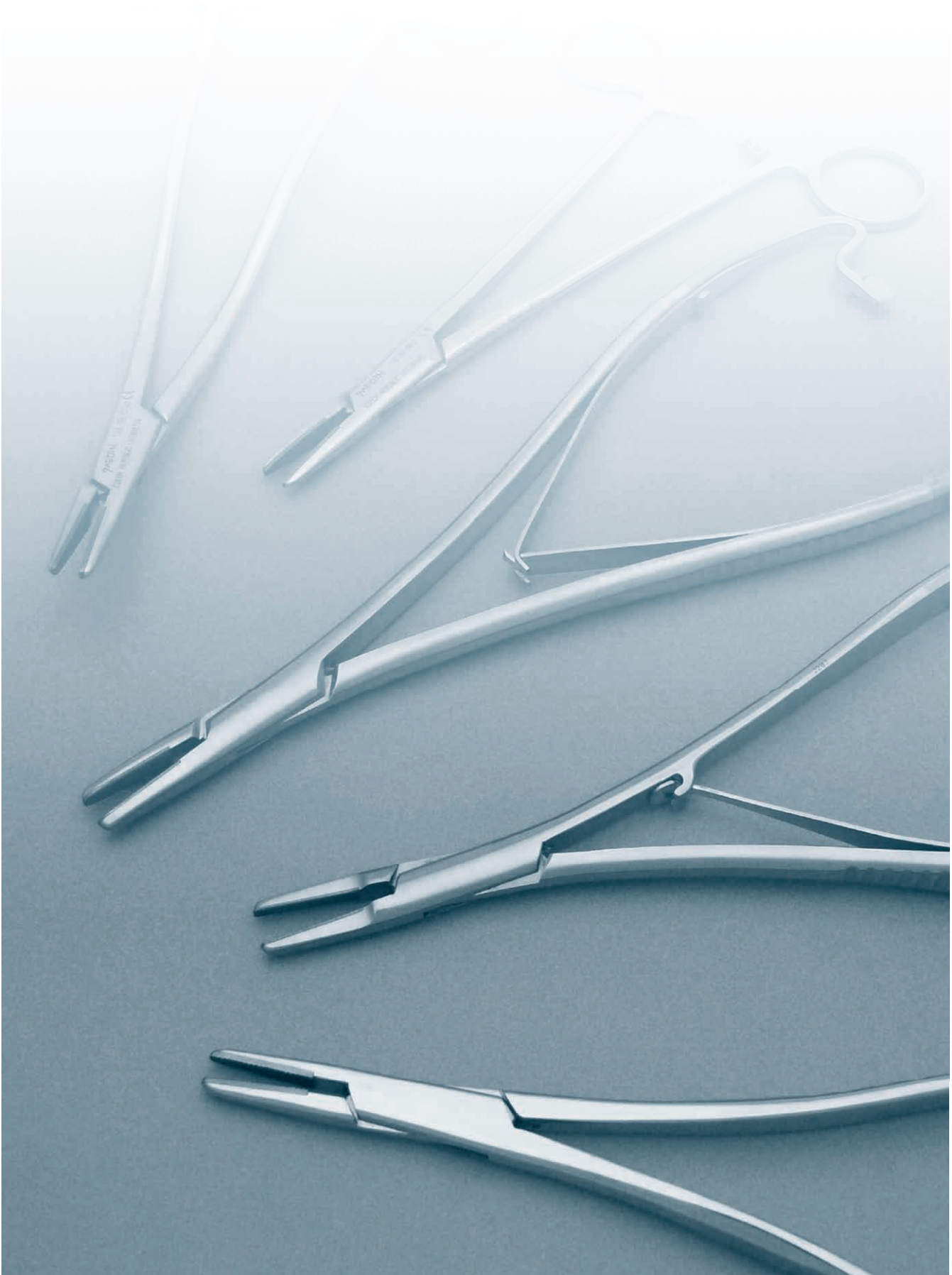





YANKAUER
18,0 cm

 ZAVADĚČE DRENŮ
 DRAIN INTRODUCERS

LUNIATSCHEK
132 50 0180
17,0 cm



LUNIATSCHEK
132 50 0186
16,8 cm



LUNIATSCHEK
132 56 0186
16,8 cm



LUNIATSCHEK
132 50 0196
žlábkový – grooved
16,8 cm

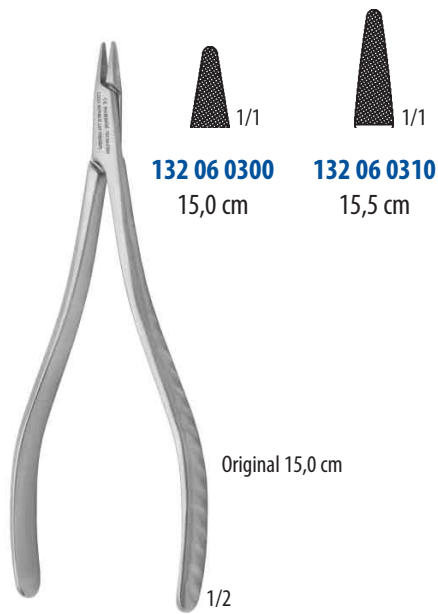
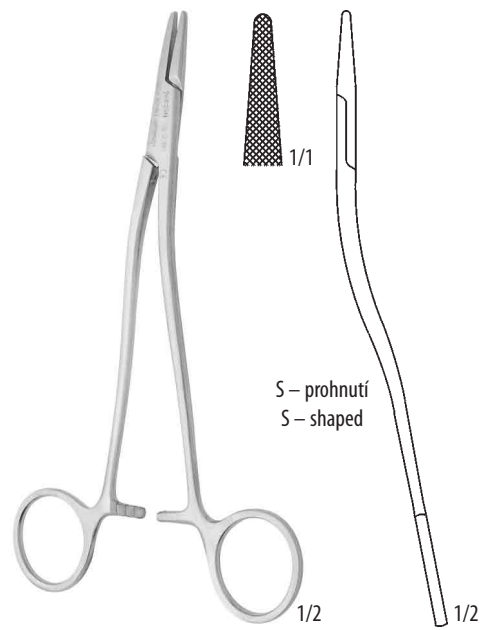
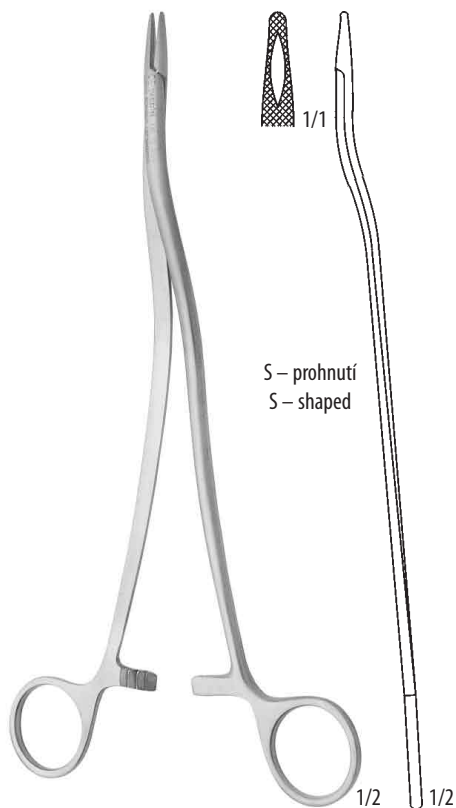

LUNIATSCHEK
132 56 0196
žlábkový – grooved
16,8 cm

**CRILE****132 12 0011**
16,2 cm**132 12 0020**
21,0 cm**BOYNTON**
132 38 0120
12,5 cm

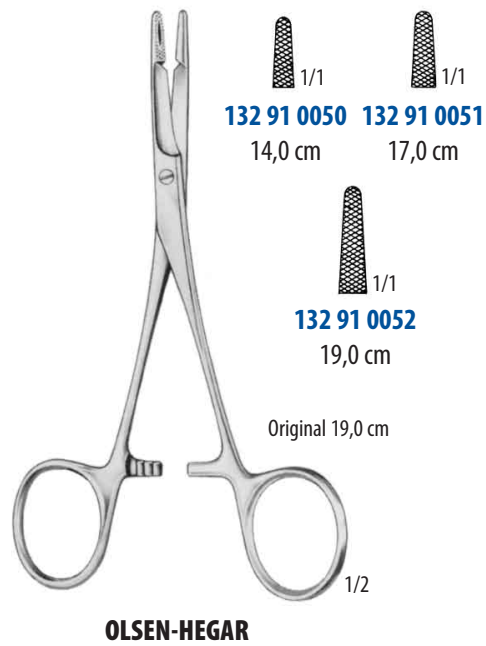



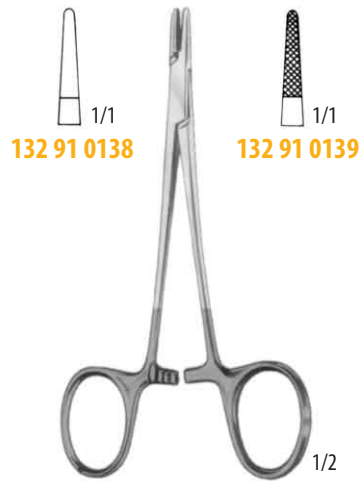

RYDER/FRENCH-EYE
132 06 0600

16,5 cm

HALSEY

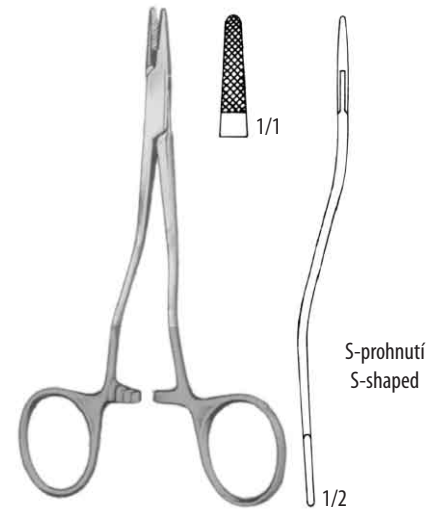
13,0 cm

KILNER
132 91 0135

13,5 cm

BABY-CRILE-WOOD
132 91 0140

15,0 cm

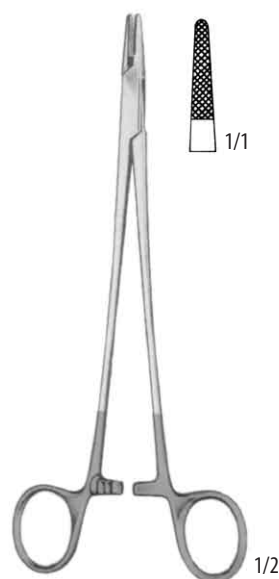

CRILE-WOOD
132 91 0142

15,0 cm

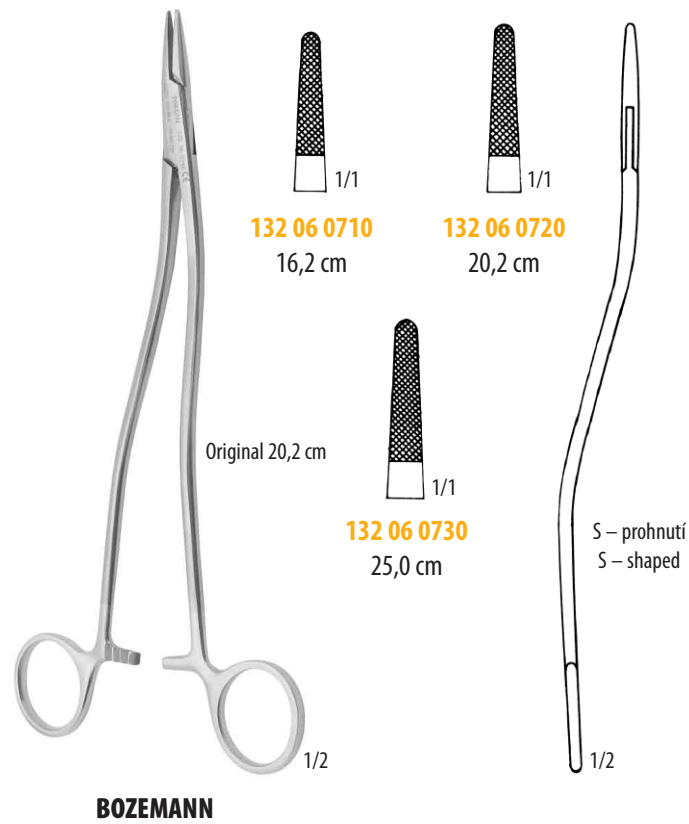

MATHIEU
132 06 0520

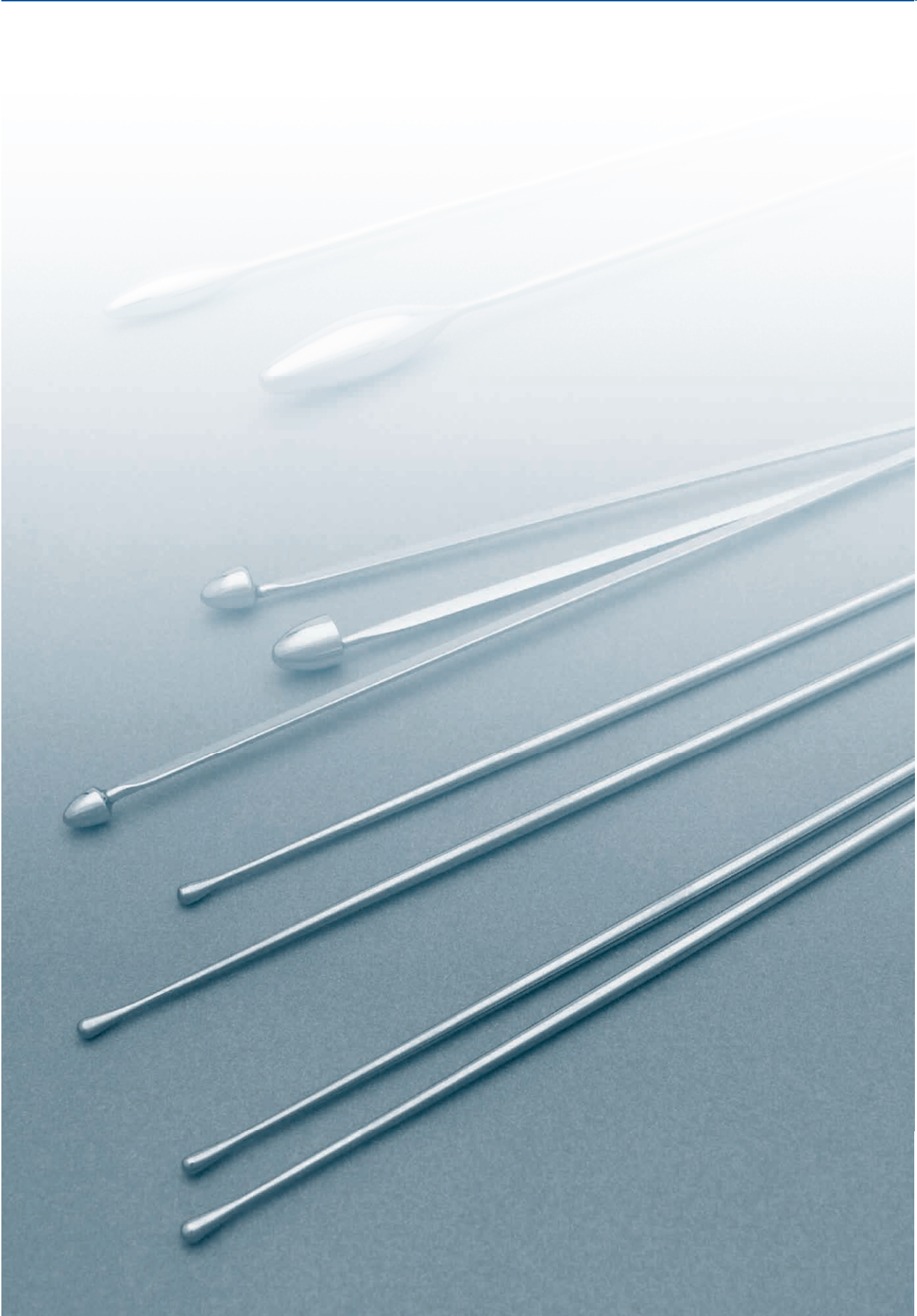
14,0 cm



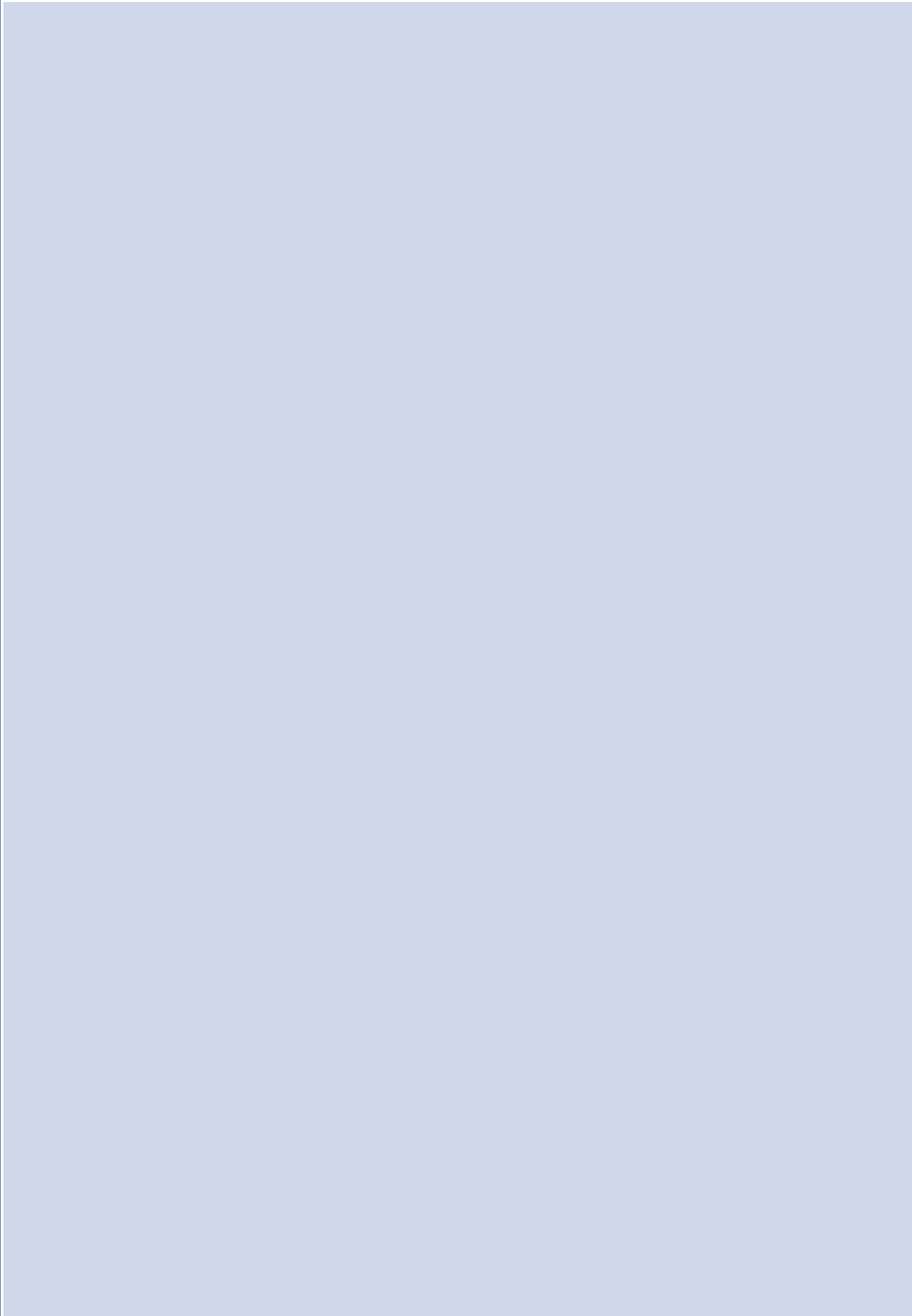

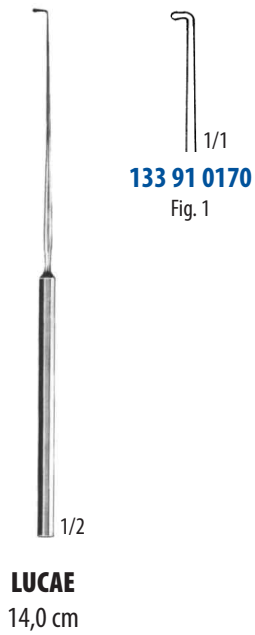



133 91 0170
Fig. 1

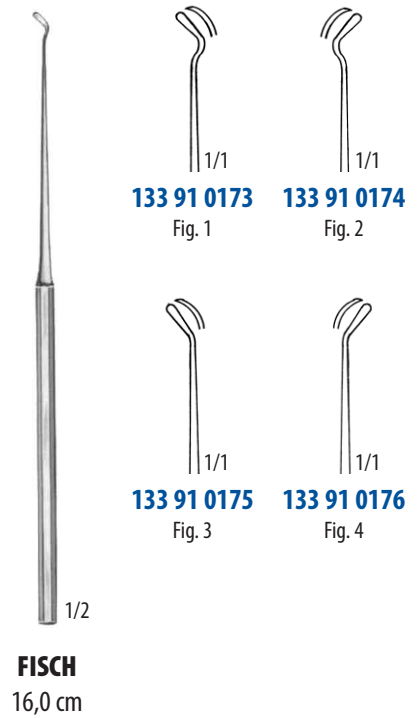
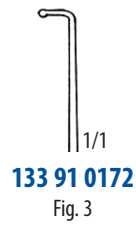
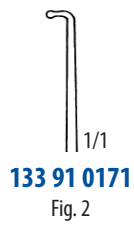

133 91 0173
Fig. 1

133 91 0174
Fig. 2

133 91 0175
Fig. 3

133 91 0176
Fig. 4

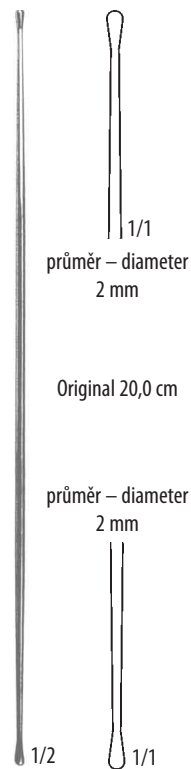

PÁTRADLO PALIČKOVÉ OBOUSTRANNÉ
PROBE OLIVE

133 08 0020 15,0 cm
133 08 0050 20,0 cm
133 08 0060 25,0 cm

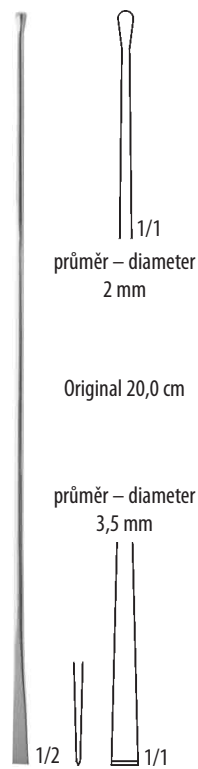

PÁTRADLO PALIČKOVÉ S DLÁTKEM
PROBE OLIVE WITH CHISEL

133 08 0100 15,0 cm
133 08 0110 20,0 cm
133 08 0120 25,0 cm

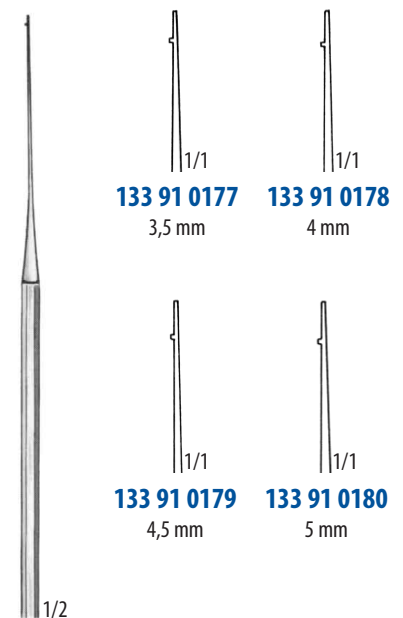

HOUSE
16,0 cm

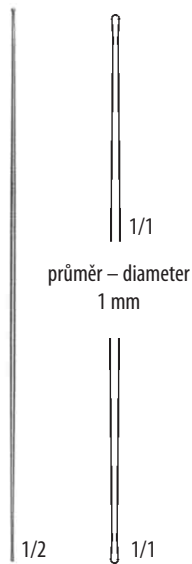

PÁTRADLO PALIČKOVÉ OBOUSTRANNÉ
PROBE OLIVE
133 08 0140
14,5 cm

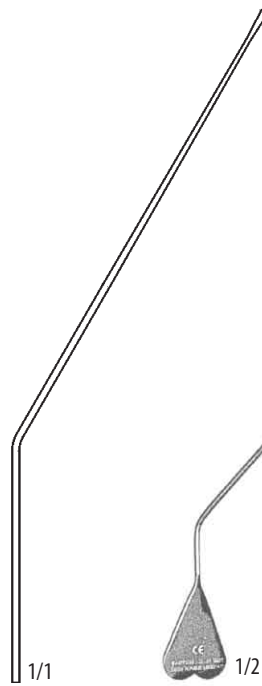

PÁTRADLO UŠNÍ
AURAL PROBE
133 29 0010
9,5 cm
průměr – diameter
1 mm

Original 13,7 cm

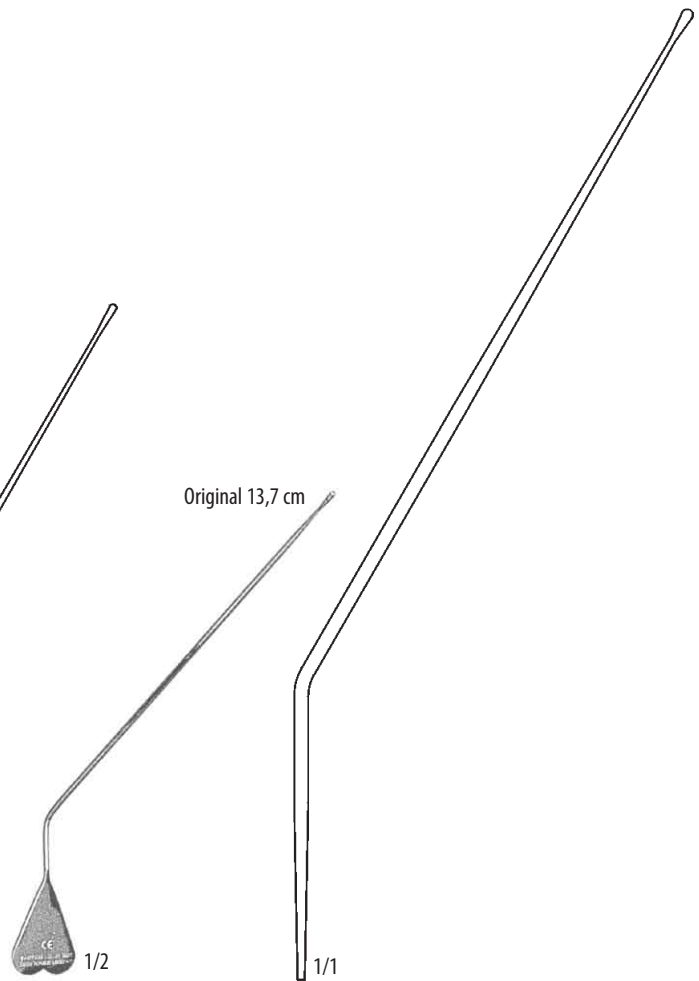

PÁTRADLO NOSNÍ
NASAL PROBE
133 30 0030
13,7 cm
průměr – diameter
1,6 mm



1/2

133 29 0110

 14,0 cm
průměr – diameter
0,8 mm

1/2

KOCHER
133 35 0010
15,5 cm
12 mm
průměr – diameter
2 mm

1/2

KOCHER

Original 15,0 cm



1/1

133 91 0165
15,0 cm
Fig. 1

1/1

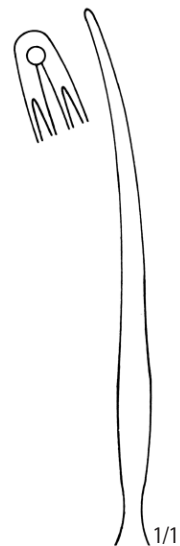
133 91 0167
15,0 cm
Fig. 2

1/1

133 91 0169
18,0 cm
Fig. 3

133 91 0166
16,0 cm
Fig. 1

133 91 0168
16,0 cm
Fig. 2



133 31 0050
držák rovný – straight holder
16,7 cm
průměr – diameter
1,5 mm



133 31 0060
držák šikmý – angled holder
16,0 cm
průměr – diameter
2 mm



133 31 0070
držák kruhový zahnutý – round curved holder
15,0 cm
průměr – diameter
1,5 mm

133 31 0100
sada – set
133 31 0050
133 31 0060
133 31 0070

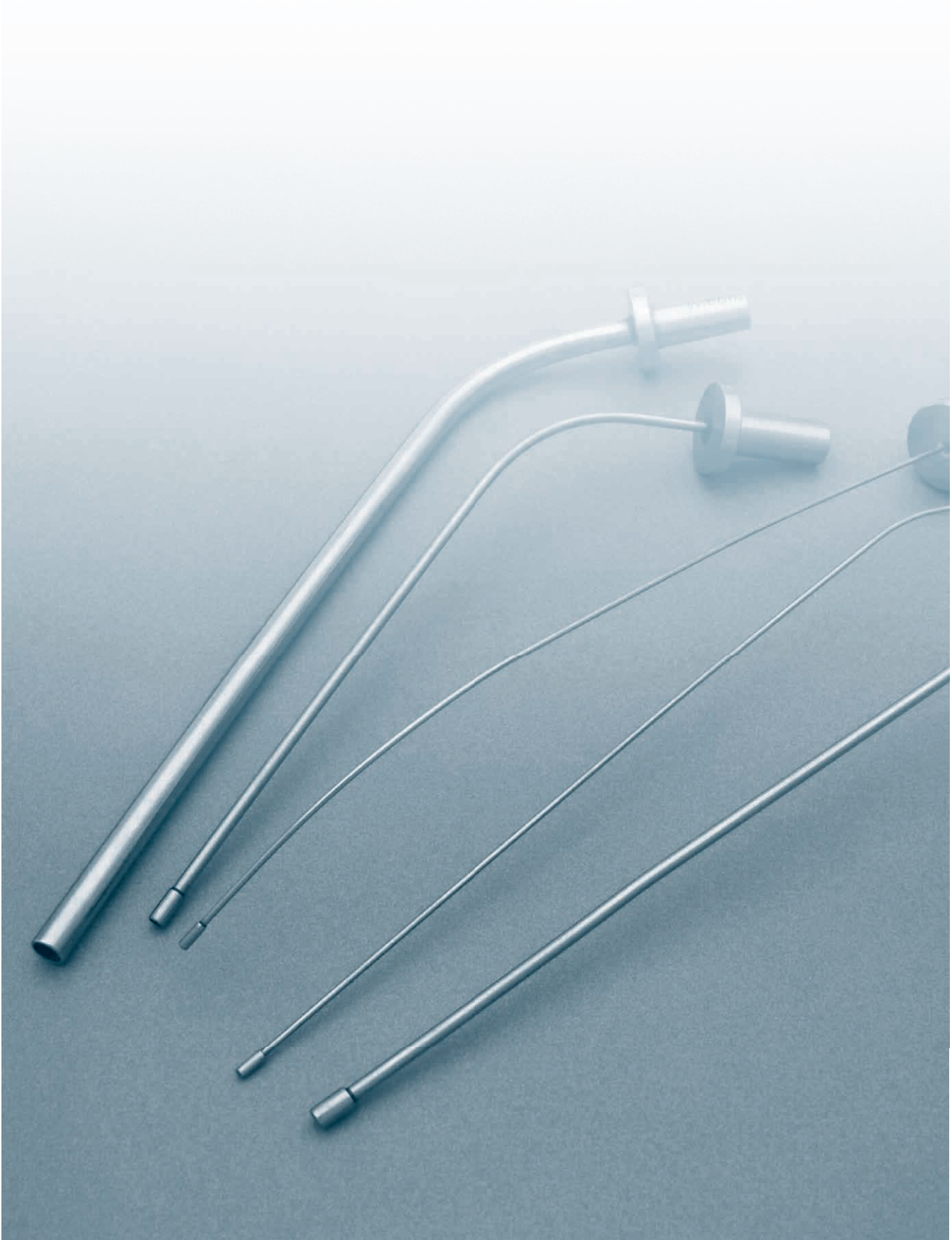



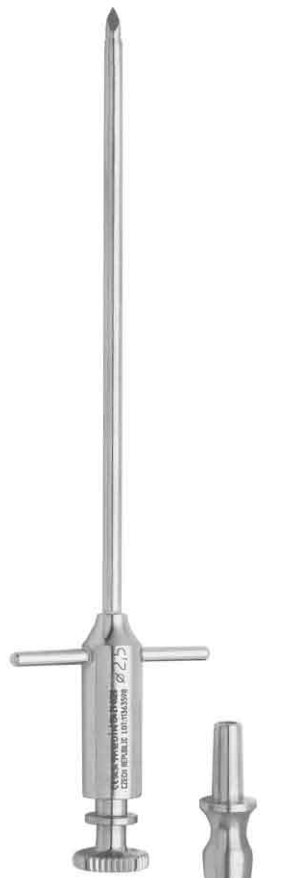

11,4 cm

134 29 0030

1/1

průměr – diameter

134 29 0050	1,5 mm
134 29 0010	2,0 mm
134 29 0020	2,5 mm
134 29 0030	3,0 mm
134 29 0040	3,5 mm



134 91 0176
průměr – diameter
7,5 mm

134 91 0177
průměr – diameter
9 mm

UCKERMANN
13,0 cm

ODSÁVAČKY
SUCTION TUBESDRŽADLO
HANDLE

bez regulace – without regulation

134 08 0080

8,0 cm

DRŽADLO
HANDLE

s regulací – with regulation

134 08 0090

8,0 cm

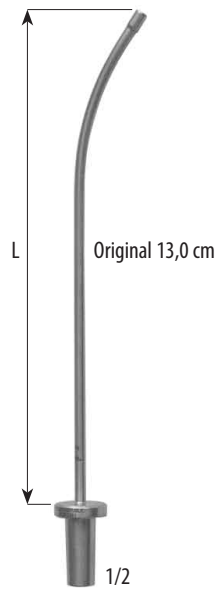
**134 08 0100**

L

13,0 cm

134 08 0110

L

13,0 cm

134 08 0120

L

13,0 cm

134 08 0200

L

15,0 cm

134 08 0210

L

15,0 cm

134 08 0220

L

15,0 cm

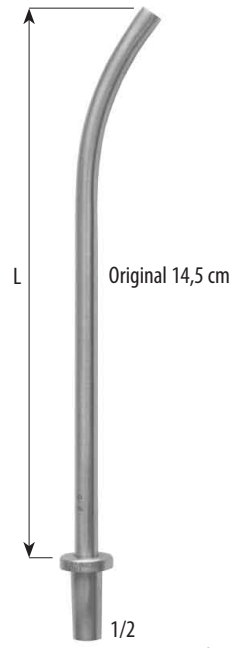
**134 08 0130**

L

14,5 cm

134 08 0140

L

14,5 cm

134 08 0150

L

14,5 cm

134 08 0230

L

16,5 cm

134 08 0240

L

16,5 cm

134 08 0250

L

16,5 cm

průměr
diameter

1 mm

2 mm

3 mm

1 mm

2 mm

3 mm

průměr
diameter

4 mm

5 mm

6 mm

4 mm

5 mm

6 mm

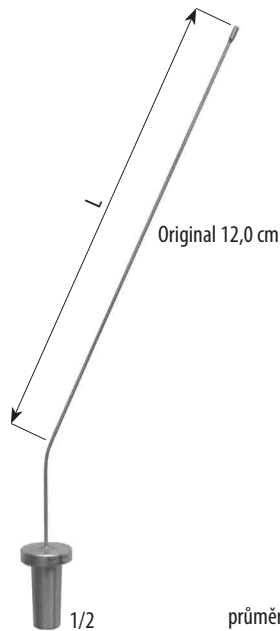
**134 08 0300**

L

8,0 cm

průměr
diameter

1 mm

134 08 0310

L

8,0 cm

2 mm

134 08 0320

L

12,0 cm

1 mm

134 08 0330

L

12,0 cm

2 mm

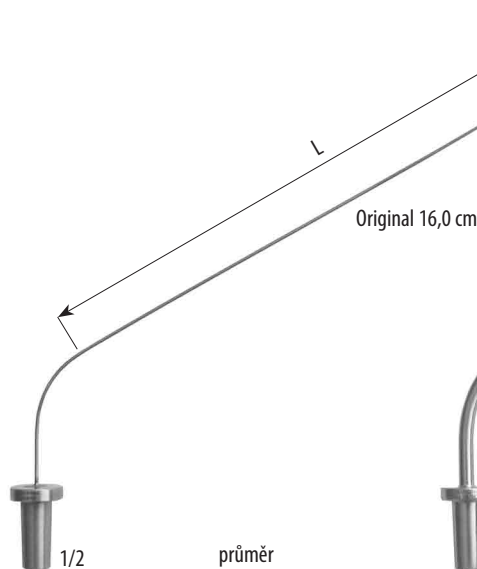
**134 08 0400**

L

9,0 cm

průměr
diameter

1 mm

134 08 0410

L

9,0 cm

2 mm

134 08 0420

L

9,0 cm

3 mm

134 08 0500

L

12,0 cm

1 mm

134 08 0510

L

12,0 cm

2 mm

134 08 0520

L

12,0 cm

3 mm

134 08 0600

L

16,0 cm

1 mm

134 08 0610

L

16,0 cm

2 mm

134 08 0620

L

16,0 cm

3 mm

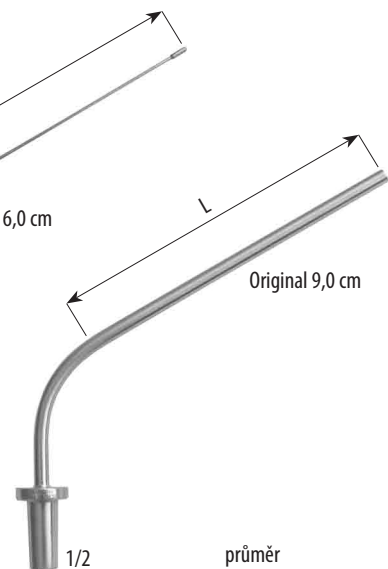
**134 08 0430**

L

9,0 cm

průměr
diameter

4 mm

134 08 0440

L

9,0 cm

5 mm

134 08 0530

L

12,0 cm

4 mm

134 08 0540

L

12,0 cm

5 mm

134 08 0630

L

16,0 cm

4 mm

134 08 0640

L

16,0 cm

5 mm

1/1
koncovka LUER
transition piece LUER

134 99 0029
12,5 cm
průměr – diameter
2,5 mm

1/1
KANYLA LARYNGEÁLNÍ
LARYNGEAL CANNULA
koncovka LUER
transition piece LUER

134 99 0562
13,0 cm
průměr – diameter
2,5 mm

1/1
KANYLA LARYNGEÁLNÍ
LARYNGEAL CANNULA
koncovka LUER
transition piece LUER

134 99 0563
15,0 cm
průměr – diameter
2,5 mm

1/1
koncovka LUER
transition piece LUER

134 99 0156
8,5 cm
průměr – diameter
1,2 mm

1/1
koncovka LUER
transition piece LUER

134 99 0164
8,5 cm
průměr – diameter
2 mm

1/1
koncovka LUER
transition piece LUER

134 99 0186
8,5 cm
průměr – diameter
1,5 – 0,6 mm

1/1
PŘECHODKA LUER
LUER CONNECTING PIECE

134 99 0175

1/1
koncovka LUER
transition piece LUER

L
Original 8,0 cm

	L	průměr diameter
134 99 0246	8,0 cm	1,2 mm
134 99 0247	8,0 cm	1,5 mm
134 99 0315	10,0 cm	1,2 mm
134 99 0314	10,0 cm	1,5 mm

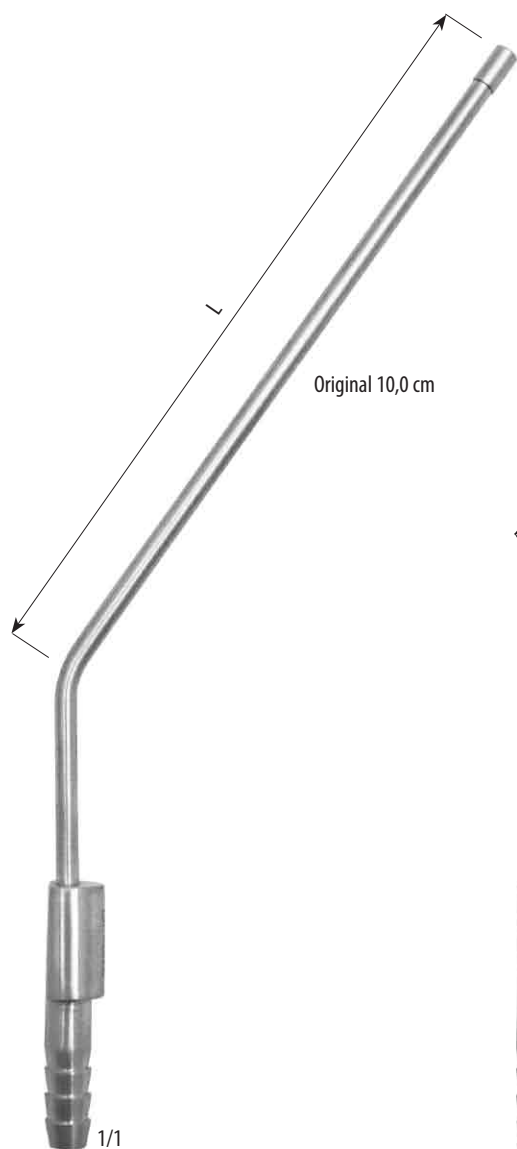
ODSÁVAČKY
SUCTION TUBES

s regulací – with regulation

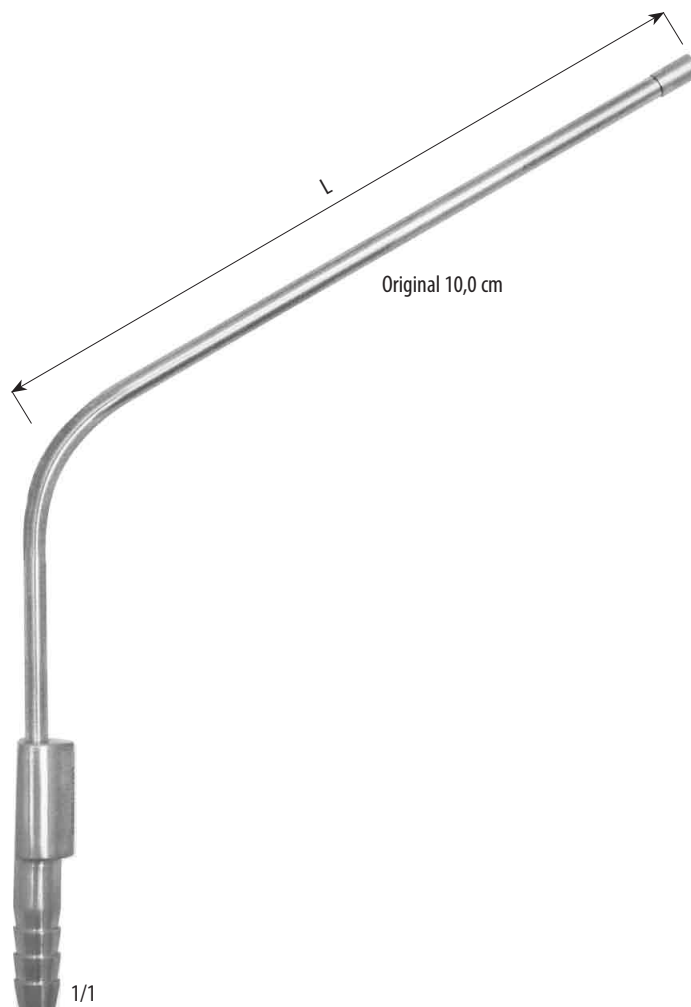

s regulací – with regulation

	L	průměr diameter
134 99 0268	10,0 cm	1 mm
134 99 0126	10,0 cm	1,5 mm
134 99 0267	8,0 cm	1,5 mm
134 99 0128	5,0 cm	2 mm
134 99 0129	8,0 cm	2 mm
134 99 0130	10,0 cm	2 mm
134 99 0131	12,0 cm	2 mm
134 99 0132	5,0 cm	3 mm
134 99 0133	8,0 cm	3 mm
134 99 0134	10,0 cm	3 mm

	L	průměr diameter
134 99 0307	10,0 cm	2 mm
134 99 0308	8,0 cm	2 mm
134 99 0309	8,0 cm	1,5 mm
134 99 0310	5,0 cm	1,5 mm

HOUSE

134 91 0204	0,9 + 0,7 mm
134 91 0205	1,2 + 0,9 mm
134 91 0206	1,5 + 1,2 mm
134 91 0207	1,8 + 1,8 mm
134 91 0208	2,5 + 2,0 mm
134 91 0209	3,0 + 2,0 mm
134 91 0210	4,5 + 2,0 mm

BARON (SCHUKNECHT)

134 91 0211	1,0 × 75 mm
134 91 0212	1,5 × 75 mm
134 91 0213	2,0 × 75 mm

HOUSE

134 91 0219	0,6 mm
134 91 0220	0,8 mm
134 91 0221	1,0 mm
134 91 0222	1,2 mm
134 91 0223	1,5 mm
134 91 0224	1,8 mm
134 91 0225	2,0 mm
134 91 0226	2,2 mm
134 91 0227	2,5 mm
134 91 0228	3,0 mm

ZÖLLNER
134 91 0214

134 91 0215
 průměr – diameter
 0,5 mm

134 91 0216
 průměr – diameter
 0,7 mm

WULLSTEIN
134 91 0217

WULLSTEIN
134 91 0218

HARTMANN
 14,0 cm

- **134 91 0229**
Fig. 0
- **134 91 0230**
Fig. 1
- **134 91 0231**
Fig. 2
- **134 91 0232**
Fig. 3
- **134 91 0233**
Fig. 4
- **134 91 0234**
Fig. 5

TRACHEÁLNÍ KANYLY
TRACHEAL TUBES

	Fig. 0	Fig. 1	Fig. 2	Fig. 3	Fig. 4	Fig. 5	Fig. 6	Fig. 7	Fig. 8	Fig. 9
průměr – diameter	4 mm	5 mm	6 mm	7 mm	8 mm	9 mm	10 mm	11 mm	12 mm	13 mm
délka vnější kanyly – length of outer tube	45 mm	50 mm	55 mm	60 mm	65 mm	70 mm	75 mm	80 mm	85 mm	90 mm

alpaka – German silver

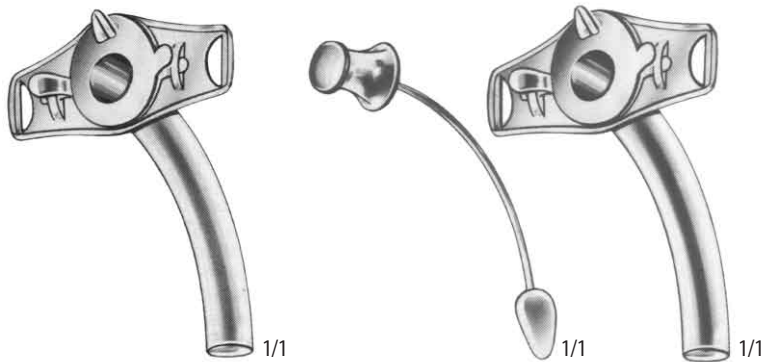

mluvící kanyla – speaking tube

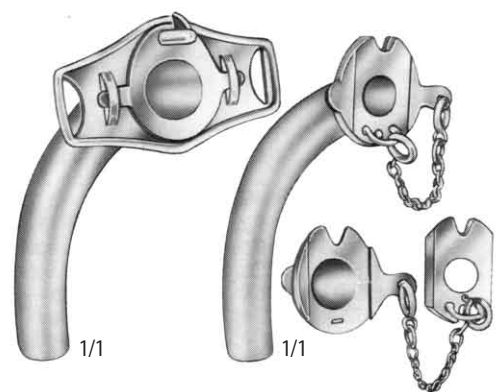
**LUER – STANDARD**

	45 – 90 mm	
Fig. 0	134 91 0178	4 mm
Fig. 1	134 91 0179	5 mm
Fig. 2	134 91 0180	6 mm
Fig. 3	134 91 0181	7 mm
Fig. 4	134 91 0182	8 mm
Fig. 5	134 91 0183	9 mm
Fig. 6	134 91 0184	10 mm
Fig. 7	134 91 0185	11 mm
Fig. 8	134 91 0186	12 mm
Fig. 9	134 91 0187	13 mm

CHEVALIER-JACKSON

	45 – 90 mm	
Fig. 0	134 91 0188	4 mm
Fig. 1	134 91 0189	5 mm
Fig. 2	134 91 0190	6 mm
Fig. 3	134 91 0191	7 mm
Fig. 4	134 91 0192	8 mm
Fig. 5	134 91 0193	9 mm
Fig. 6	134 91 0194	10 mm
Fig. 7	134 91 0195	11 mm
Fig. 8	134 91 0196	12 mm
Fig. 9	134 91 0197	13 mm

65 – 90 mm

Fig. 4	134 91 0198	8 mm
Fig. 5	134 91 0199	9 mm
Fig. 6	134 91 0200	10 mm
Fig. 7	134 91 0201	11 mm
Fig. 8	134 91 0202	12 mm
Fig. 9	134 91 0203	13 mm





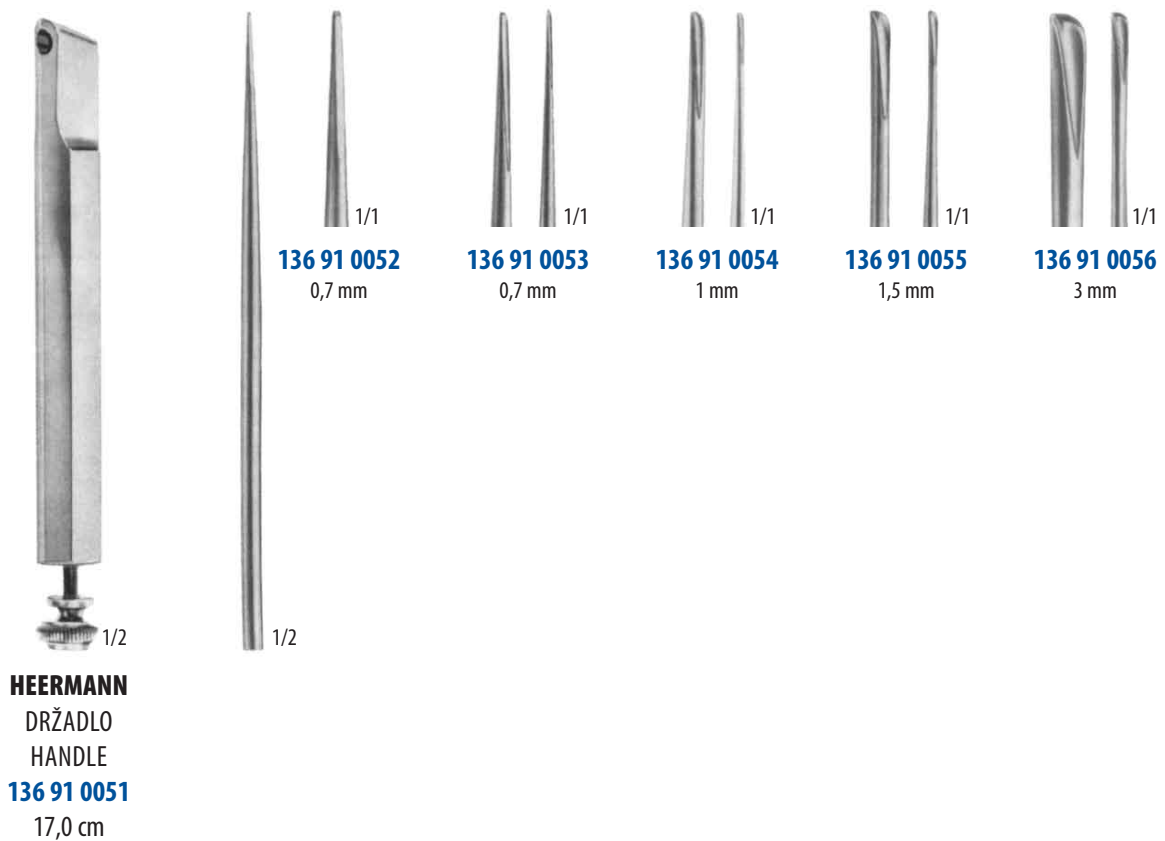
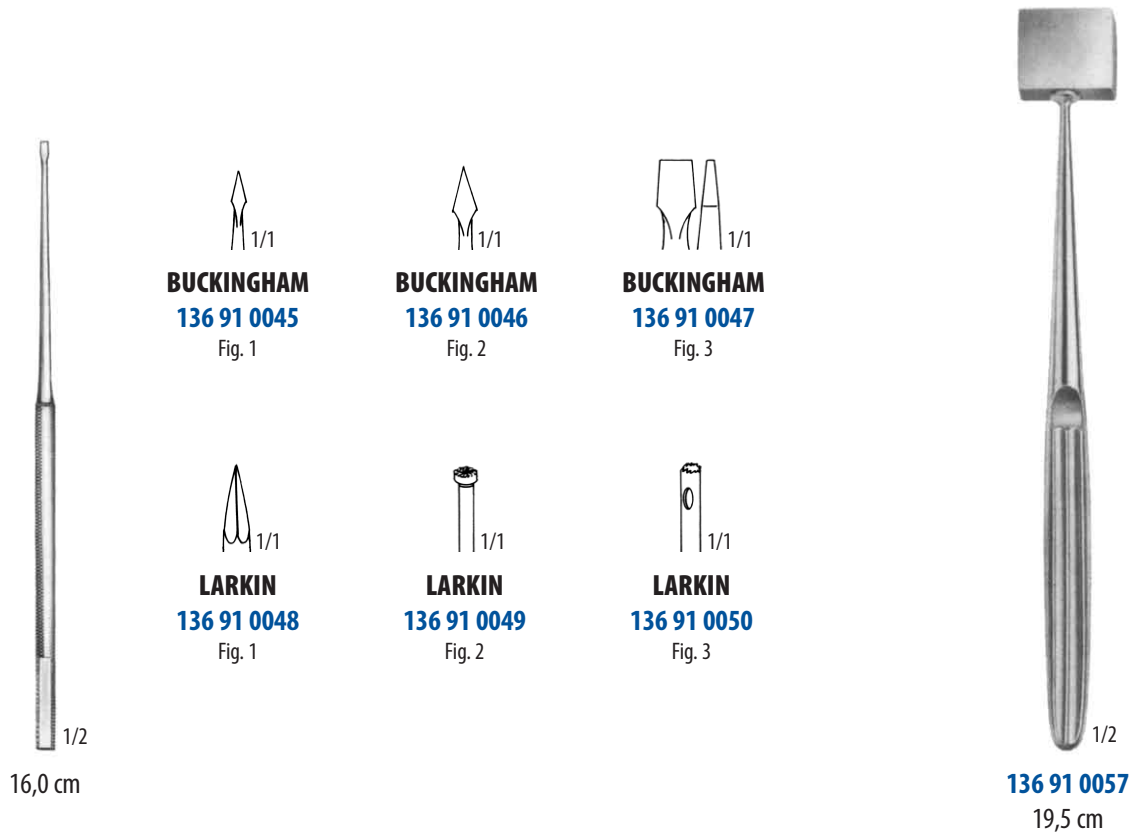



1/2

136 91 0058

1/2

136 91 0059

1/2

136 91 0060

1/2

136 91 0061komplet – complete
50 ml**136 91 0058****136 91 0059****136 91 0060****136 91 0062**komplet – complete
75 ml**136 91 0058****136 91 0059****136 91 0060****136 91 0063**komplet – complete
100 ml**136 91 0058****136 91 0059****136 91 0060**

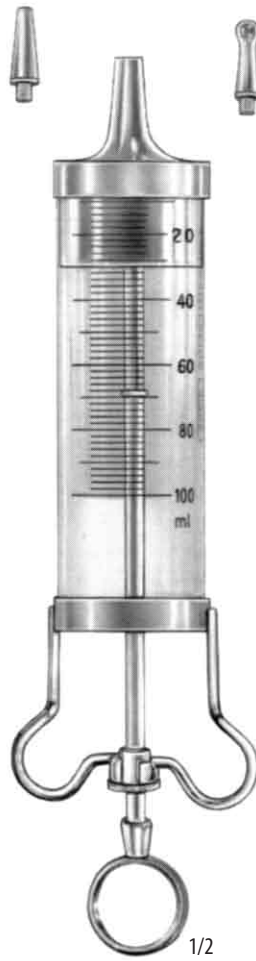

JANET

136 91 0153	50 ml
136 91 0154	100 ml
136 91 0155	150 ml
136 91 0156	200 ml

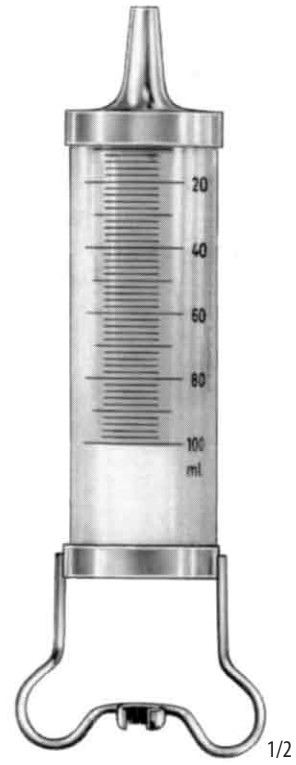

136 91 0157	50 ml
136 91 0158	100 ml
136 91 0159	150 ml
136 91 0160	200 ml

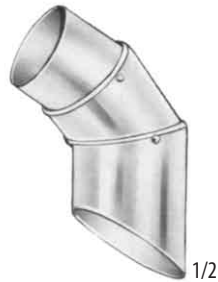
CHRÁNIČE PRSTU
FINGER PROTECTORS
**LANGENBECK**

průměr – diameter

136 91 0001 22,0 mm**136 91 0002** 24,5 mm**136 91 0003** 26,5 mm
ZÁVAŽÍ DO ÚST
ORAL WEDGES
**MAUNDER****136 91 0043**

10,0 cm

**PITHA****136 91 0044**

9,0 cm

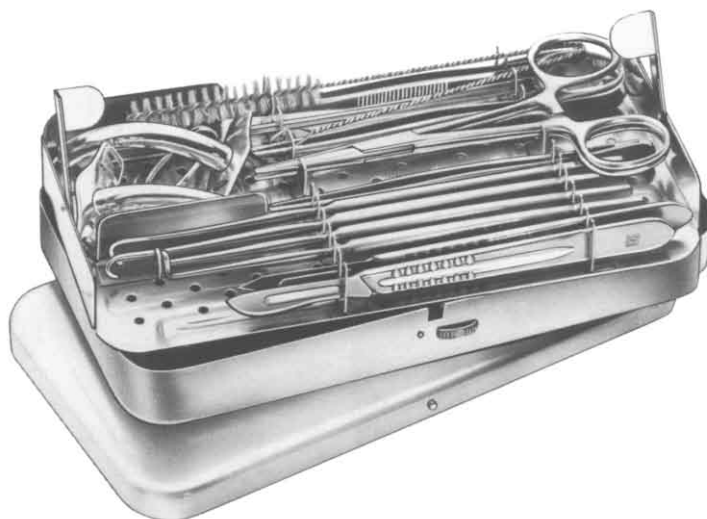

136 91 0068

soubor – set

		počet ks – number of pcs	
	KOVOVÁ KRABÍČKA	METAL CASE	1
112 91 0004	DRŽÁTKO S ČEPELKOU Fig. 20	HANDLE WITH 1 BLADE; Fig. 20	1
112 91 0004	DRŽÁTKO S ČEPELKOU Fig. 23	HANDLE WITH 1 BLADE; Fig. 23	1
114 91 0003	ANATOMICKÁ PINZETA; 13,0 cm	DRESSING FORCEPS; 13,0 cm	1
114 91 0012	CHIRURGICKÁ PINZETA; 13,0 cm	TISSUE FORCEPS; 13,0 cm	2
115 91 0149	PEAN SVORKA CÉVNÍ; 13,0 cm	PEAN ARTERY FORCEPS; 13,0 cm	2
133 91 0028	SONDA ŽLÁBKOVÁ; 13,0 cm	GROOVED DIRECTOR; 13,0 cm	1
119 91 0237	BOSE TRACHEÁLNÍ ROZVĚRAČ	BOSE TRACHEA DILATOR	1
118 91 0321	ITERSON HÁK NA PRŮDUŠNICI; tupý	ITERSON TRACHEA RETRACTORS; blunt	2
118 91 0318	BOSE HÁK NA PRŮDUŠNICI; ostrý, levý	BOSE TRACHEA RETRACTORS; sharp, left	1
118 91 0319	BOSE HÁK NA PRŮDUŠNICI; ostrý, pravý	BOSE TRACHEA RETRACTORS; sharp, right	1
134 91 0181	LUER KANYLA TRACHEÁLNÍ; Fig. 3	STANDARD LUER TRACHEA TUBE; Fig. 3	1
134 91 0182	LUER KANYLA TRACHEÁLNÍ; Fig. 4	STANDARD LUER TRACHEA TUBE; Fig. 4	1
	ČISTÍCÍ KARTÁČEK	CLEANING BRUSH	1

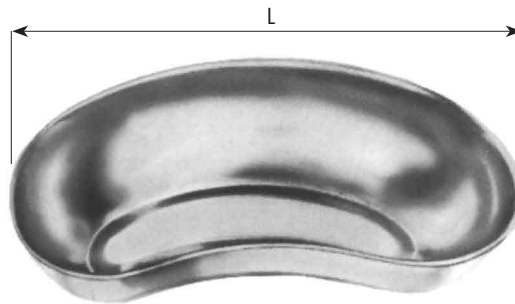

		průměr × výška diameter × height
136 91 0077	0,05 l	4,0 × 1,9 cm
136 91 0078	0,07 l	6,1 × 3,0 cm
136 91 0079	0,14 l	8,0 × 4,0 cm
136 91 0080	0,35 l	11,6 × 5,0 cm
136 91 0081	0,45 l	12,8 × 5,5 cm
136 91 0082	0,70 l	14,7 × 6,5 cm



	L
136 91 0087	17,0 cm
136 91 0088	25,0 cm
136 91 0089	27,5 cm

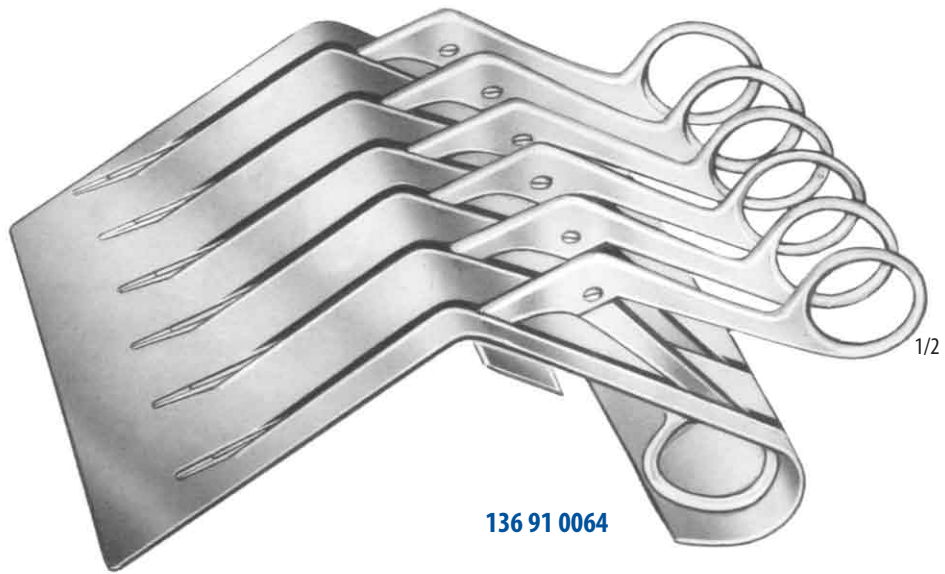

136 91 0064

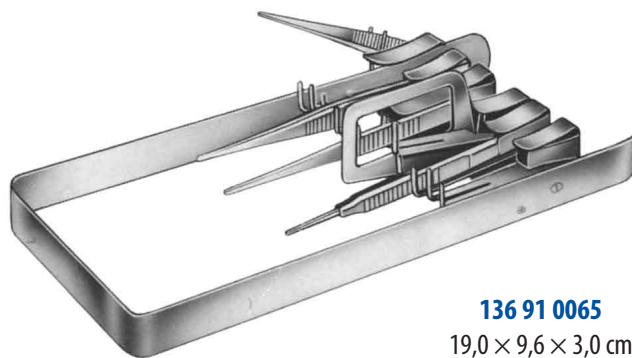

136 91 0065
19,0 × 9,6 × 3,0 cm

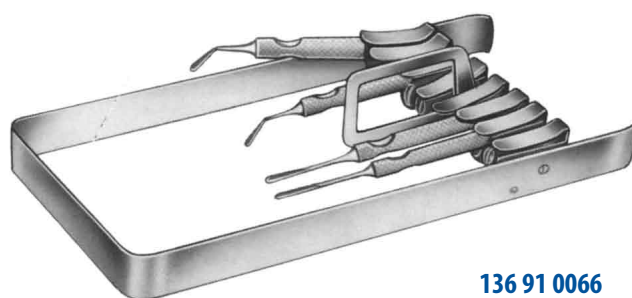



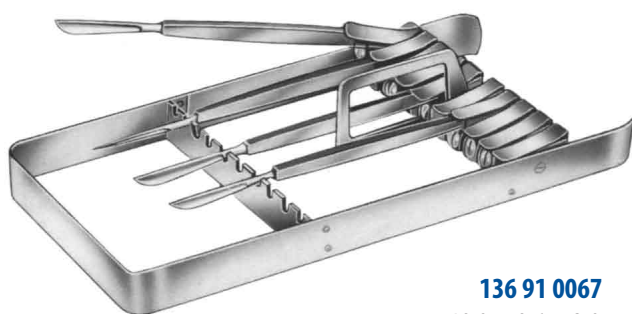









136 91 0066
19,0 × 9,6 × 3,0 cm



136 91 0067
19,0 × 9,6 × 3,0 cm



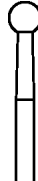

							
1/1	1/1	1/1	1/1	1/1	1/1	1/1	1/1
9,5 cm	průměr – diameter 0,6 mm	průměr – diameter 0,8 mm	průměr – diameter 1 mm	průměr – diameter 1,4 mm	průměr – diameter 1,8 mm	průměr – diameter 2,3 mm	7,0 cm
	146 29 0180	146 29 0010	146 29 0030	146 29 0050	146 29 0070	146 29 0090	
	7,0 cm	7,0 cm	7,0 cm	7,0 cm	7,0 cm	7,0 cm	
	146 29 1180	146 29 1010	146 29 1030	146 29 1050	146 29 1070	146 29 1090	
	9,5 cm	9,5 cm	9,5 cm	9,5 cm	9,5 cm	9,5 cm	
							
	1/1	1/1	1/1	1/1	1/1		
	průměr – diameter 2,9 mm	průměr – diameter 3,1 mm	průměr – diameter 3,3 mm	průměr – diameter 3,7 mm	průměr – diameter 4,2 mm		
	146 29 0120	146 29 0130	146 29 0140	146 29 0150	146 29 0160		
	7,0 cm	7,0 cm	7,0 cm	7,0 cm	7,0 cm		
	146 29 1120	146 29 1130	146 29 1140	146 29 1150	146 29 1160		
	9,5 cm	9,5 cm	9,5 cm	9,5 cm	9,5 cm		

číslo – number	název	item	strana – page
111	DIAGNOSTIKA	DIAGNOSTIC	
111 91 0001	McIntosh laryngoskop komplet	McIntosh laryngoscope set	15
111 91 0002	McIntosh laryngoskop komplet	McIntosh laryngoscope set	15
111 91 0003	McIntosh laryngoskopová lžice fig.0; 5,5 cm	McIntosh blade fig.0; 5,5 cm	15
111 91 0004	McIntosh laryngoskopová lžice fig.1; 7,5 cm	McIntosh blade fig.1; 7,5 cm	15
111 91 0005	McIntosh laryngoskopová lžice fig.2; 9,0 cm	McIntosh blade fig.2; 9,0 cm	15
111 91 0006	McIntosh laryngoskopová lžice fig.3; 11,0 cm	McIntosh blade fig.3; 11,0 cm	15
111 91 0007	McIntosh laryngoskopová lžice fig.4; 13,5 cm	McIntosh blade fig.4; 13,5 cm	15
111 91 0008	Foregger (Wisconsin) laryngoskop komplet	Foregger (Wisconsin) laryngoscope set	16
111 91 0009	Foregger (Wisconsin) laryngoskop komplet	Foregger (Wisconsin) laryngoscope set	16
111 91 0010	Foregger laryngoskopová lžice fig.0; 7,0 cm	Foregger blade fig.0; 7,0 cm	16
111 91 0011	Foregger laryngoskopová lžice fig.1; 9,5 cm	Foregger blade fig.1; 9,5 cm	16
111 91 0012	Foregger laryngoskopová lžice fig.2; 11,0 cm	Foregger blade fig.2; 11,0 cm	16
111 91 0013	Foregger laryngoskopová lžice fig.3; 14,0 cm	Foregger blade fig.3; 14,0 cm	16
111 91 0014	Foregger laryngoskopová lžice fig.4; 17,0 cm	Foregger blade fig.4; 17,0 cm	16
111 91 0015	Miller laryngoskop komplet	Miller laryngoscope set	17
111 91 0016	Miller laryngoskop komplet	Miller laryngoscope set	17
111 91 0017	Miller laryngoskopová lžice fig.0; 5,5 cm	Miller blade fig.0; 5,5 cm	17
111 91 0018	Miller laryngoskopová lžice fig.1; 8,0 cm	Miller blade fig.1; 8,0 cm	17
111 91 0019	Miller laryngoskopová lžice fig.2; 13,0 cm	Miller blade fig.2; 13,0 cm	17
111 91 0020	Miller laryngoskopová lžice fig.3; 17,0 cm	Miller blade fig.3; 17,0 cm	17
111 91 0021	Miller laryngoskopová lžice fig.4; 18,0 cm	Miller blade fig.4; 18,0 cm	17
111 91 0022	Držadlo s baterií; 19,0 cm	Battery handle; 19,0 cm	18
111 91 0023	Držadlo s baterií; 28,0 cm	Battery handle; 28,0 cm	18
111 91 0024	Držadlo s baterií; 37,0 cm	Battery handle; 37,0 cm	18
111 91 0025	Akumulátor do držadla	Accumulator insert for battery handle	18
111 91 0026	Žárovka velká do laryngoskopu fig.2-4	Laryngoscope bulb large size fig.2-4	18
111 91 0027	Žárovka malá do laryngoskopu fig.0-1	Laryngoscope bulb small size fig.0-1	18
111 91 0028	McIntosh laryngoskop se studeným světlem komplet	McIntosh fibre optic laryngoscope set	19
111 91 0029	McIntosh laryngoskop se studeným světlem komplet	McIntosh fibre optic laryngoscope set	19
111 91 0030	McIntosh laryngoskop. lžice (studené světlo) fig.0; 5,5 cm	McIntosh fibre optic blade fig.0; 5,5 cm	19
111 91 0031	McIntosh laryngoskop. lžice (studené světlo) fig.1; 7,0 cm	McIntosh fibre optic blade fig.1; 7,0 cm	19
111 91 0032	McIntosh laryngoskop. lžice (studené světlo) fig.2; 8,0 cm	McIntosh fibre optic blade fig.2; 8,0 cm	19
111 91 0033	McIntosh laryngoskop. lžice (studené světlo) fig.3; 10,5 cm	McIntosh fibre optic blade fig.3; 10,5 cm	19
111 91 0034	McIntosh laryngoskop. lžice (studené světlo) fig.4; 13,0 cm	McIntosh fibre optic blade fig.4; 13,0 cm	19
111 91 0035	Foregger laryngoskop se studeným světlem komplet	Foregger fibre optic laryngoscope set	20
111 91 0036	Foregger laryngoskop se studeným světlem komplet	Foregger fibre optic laryngoscope set	20
111 91 0037	Foregger laryngoskop. lžice (studené světlo) fig.0; 7,0 cm	Foregger fibre optic blade fig.0; 7,0 cm	20
111 91 0038	Foregger laryngoskop. lžice (studené světlo) fig.1; 9,5 cm	Foregger fibre optic blade fig.1; 9,5 cm	20
111 91 0039	Foregger laryngoskop. lžice (studené světlo) fig.2; 11,0 cm	Foregger fibre optic blade fig.2; 11,0 cm	20
111 91 0040	Foregger laryngoskop. lžice (studené světlo) fig.3; 14,0 cm	Foregger fibre optic blade fig.3; 14,0 cm	20
111 91 0041	Foregger laryngoskop. lžice (studené světlo) fig.4; 17,0 cm	Foregger fibre optic blade fig.4; 17,0 cm	20
111 91 0042	Miller laryngoskop se studeným světlem komplet	Miller fibre optic laryngoscope set	21
111 91 0043	Miller laryngoskop se studeným světlem komplet	Miller fibre optic laryngoscope set	21
111 91 0044	Miller laryngoskop. lžice (studené světlo) fig.0; 5,5 cm	Miller fibre optic blade fig.0; 5,5 cm	21
111 91 0045	Miller laryngoskop. lžice (studené světlo) fig.1; 8,0 cm	Miller fibre optic blade fig.1; 8,0 cm	21
111 91 0046	Miller laryngoskop. lžice (studené světlo) fig.2; 13,0 cm	Miller fibre optic blade fig.2; 13,0 cm	21
111 91 0047	Miller laryngoskop. lžice (studené světlo) fig.3; 17,0 cm	Miller fibre optic blade fig.3; 17,0 cm	21
111 91 0048	Miller laryngoskop. lžice (studené světlo) fig.4; 18,0 cm	Miller fibre optic blade fig.4; 18,0 cm	21
111 91 0049	Držadlo s baterií (studené světlo); 3,0 cm	Handle fibre optic battery; 3,0 cm	22
111 91 0050	Držadlo s baterií (studené světlo); 2,0 cm	Handle fibre optic battery; 2,0 cm	22
111 91 0051	Žárovka halogenová 2,5 v (stud.světlo)	Bulb halogen 2,5 v (fibre optic)	22
111 91 0052	Žárovka kryptonová 2,5 v (stud.světlo)	Bulb krypton 2,5 v (fibre optic)	22
111 91 0066	Lampa čelní 220 V	Head light 220 V	23
111 91 0067	Náhradní žárovka	Spare lamp	23
111 91 0068	Zrcadlo čelní s krytem; 9,0 cm	Head mirror with cover; 9,0 cm	23
111 91 0069	Zrcadlo čelní s krytem; 10,0 cm	Head mirror with cover; 10,0 cm	23
111 91 0070	Clar 55 čelní lampa 6 voltů	Clar 55 head lamp 6 volt	24
111 91 0071	Clar standard čelní lampa 6 voltů	Clar head lamp 6 volt	24
111 91 0111	Hartmann ladička; c 128; 17,0 cm	Hartmann tuning fork; c 128; 17,0 cm	12
111 91 0112	Hartmann ladička; c1 256; 17,0 cm	Hartmann tuning fork; c1 256; 17,0 cm	12
111 91 0113	Hartmann ladička; c2 512; 17,0 cm	Hartmann tuning fork; c2 512; 17,0 cm	12, 13
111 91 0114	Hartmann ladička; c3 1024; 17,0 cm	Hartmann tuning fork; c3 1024; 17,0 cm	12, 13

číslo – number	název	item	strana – page
111 91 0115	Hartmann ladička; c4 2048; 17,0 cm	Hartmann tuning fork; c4 2048; 17,0 cm	12, 13
111 91 0116	Hartmann ladička; c5 4096; 17,0 cm	Hartmann tuning fork; c5 4096; 17,0 cm	12, 13
111 91 0117	Lucae ladička; c 128; 16,5 cm	Lucae tuning fork; c 128; 16,5 cm	12
111 91 0118	Lucae ladička; c1 256; 16,5 cm	Lucae tuning fork; c1 256; 16,5 cm	12
111 91 0119	Lucae ladička; c2 512; 16,5 cm	Lucae tuning fork; c2 512; 16,5 cm	12
111 91 0120	Lucae ladička; c3 1024; 16,5 cm	Lucae tuning fork; c3 1024; 16,5 cm	12
111 91 0121	Lucae ladička; c4 2048; 16,5 cm	Lucae tuning fork; c4 2048; 16,5 cm	12
111 91 0122	Lucae ladička; c5 4096; 16,5 cm	Lucae tuning fork; c5 4096; 16,5 cm	12
111 91 0123	Hartmann-French ladička; c2 16; 16,0 cm	Hartmann-French tuning fork; c2 16; 16,0 cm	12
111 91 0124	Hartmann-French ladička; c2 32; 16,0 cm	Hartmann-French tuning fork; c2 32; 16,0 cm	12, 13
111 91 0125	Hartmann-French ladička; c 64; 16,0 cm	Hartmann-French tuning fork; c 64; 16,0 cm	12, 13
111 91 0126	Hartmann-French ladička; c 128; 16,0 cm	Hartmann-French tuning fork; c 128; 16,0 cm	12, 13
111 91 0127	Hartmann-French ladička; c1 256; 16,0 cm	Hartmann-French tuning fork; c1 256; 16,0 cm	12, 13
111 91 0128	Sada 5 Hartmann ladiček	Set of Hartmann tuning forks	13
111 91 0129	Sada 6 Hartmann ladiček	Set of Hartmann tuning forks	13
111 91 0130	Sada 8 Hartmann ladiček	Set of Hartmann tuning forks	13
111 91 0131	Ladička hliníková; c 64	Tuning fork aluminium; c 64	12
111 91 0132	Ladička hliníková; c 128	Tuning fork aluminium; c 128	12, 13
111 91 0133	Ladička hliníková; c 256	Tuning fork aluminium; c 256	12, 13
111 91 0134	Ladička hliníková; c 512	Tuning fork aluminium; c 512	12, 13
111 91 0135	Ladička hliníková; c 1024	Tuning fork aluminium; c 1024	12, 13
111 91 0136	Ladička hliníková; c 2048	Tuning fork aluminium; c 2048	12, 13
111 91 0137	Ladička hliníková; c 4096	Tuning fork aluminium; c 4096	12
111 91 0138	Sada 5 ladiček hliníkových	Set of 5 tuning forks aluminium	13
111 91 0139	Politizer sáček vzduchový komplet	Politzer air bag complete	14
111 91 0140	Politizer sáček vzduchový	Politzer air bag	14
111 91 0141	Politizer špička; 15 mm	Politzer point; 15 mm	14
111 91 0142	Politizer špička; 17 mm	Politzer point; 17 mm	14
111 91 0143	Politizer špička; 22 mm	Politzer point; 22 mm	14
111 91 0144	Politizer žárovka	Politzer bulb	14
111 91 0145	Kabierske zaprašovač komplet	Kabierske powder blower complete	14
111 91 0146	Kabierske žárovka ventilová	Kabierske valve rubber bulb	14
111 91 0147	Kabierske náhradní láhev; 30 ccm	Kabierske spare bottle; 30 ccm	14
111 91 0148	Kabierske zaprašovač - střední díl	Kabierske powder blower – middle part	14
111 91 0149	Kabierske kanyla rovná; 8,0 cm	Kabierske cannula straight; 8,0 cm	14
111 91 0150	Kabierske kanyla rovná; 11,0 cm	Kabierske cannula straight; 11,0 cm	14
111 91 0151	Kabierske kanyla zahnutá; 13,0 cm	Kabierske cannula curved; 13,0 cm	14
111 91 0159	Barany aparát zvukový; 9,6 cm	Barany sound apparatus; 9,6 cm	11
112	NÁSTROJE ŘEZNÉ	CUTTING INSTRUMENTS	
112 08 0696	Držátko skalpel. čepelek; 15,0 cm	Scalpel handle; 15,0 cm	28
112 08 0700	Klíček utahovací k držákům skalpelových čepelek; 8,0 cm	Spanner for scalpel blade holder; 8,0 cm	28
112 29 0010	Agnew jehla paracentésní-nerez; 15,7 cm	Agnew paracentesis needle; 15,7 cm	29
112 29 0020	Schwartzte jehla paracentésní; 15,7 cm	Schwartzte paracentesis needle; 15,7 cm	29
112 29 0040	Lucae jehla paracentésní; 17,5 cm	Lucae paracentesis needle; 17,5 cm	29
112 29 0100	Nůž na furunkl s kyvetou; 15,0 cm	Furuncle knife with curette; 15,0 cm	35
112 29 0110	Politizer nůž na furunkl; 17,0 cm	Politzer furuncle knife; 17,0 cm	35
112 29 0120	Schwartzte tenotom ušní fig.1	Schwartzte tenotomy knife fig.1	33
112 29 0130	Schwartzte tenotom ušní fig.2	Schwartzte tenotomy knife fig.2	33
112 29 0150	Stacke nůž na zvukodv fig.1; 12,6 cm	Stacke sounds knife fig.1; 12,6 cm	33
112 29 0160	Stacke nůž na zvukodv fig.2; 12,6 cm	Stacke sounds knife fig.2; 12,6 cm	33
112 30 0010	Halle nůž na nosní plastiku; 12,0 cm	Halle nasal plastic knife; 12,0 cm	37
112 30 0050	Joseph nůž na nosní plastiku; 14,5 cm	Joseph nasal plastic knife; 14,5 cm	37
112 30 0070	Heymann nůž na nosní plastiku; 15,5 cm	Heymann nasal plastic knife; 15,5 cm	37
112 30 0100	Joseph nůž na nosní plastiku tupý; 14,5 cm	Joseph nasal plastic knife; 14,5 cm	37
112 30 0260	Ballenger nůž na nosní přepážku fig.1; 20,0 cm	Ballenger knife for septum fig.1; 20,0 cm	36
112 30 0270	Ballenger nůž na nosní přepážku fig.2; 20,0 cm	Ballenger knife for septum fig.2; 20,0 cm	36
112 30 0300	Beckmann kyreta nosohltnová fig.1; 21,3 cm	Beckmann adenoid curette fig.1; 21,3 cm	39
112 30 0310	Beckmann kyreta nosohltnová fig.2; 21,4 cm	Beckmann adenoid curette fig.2; 21,4 cm	39
112 30 0320	Beckmann kyreta nosohltnová fig.3; 21,4 cm	Beckmann adenoid curette fig.3; 21,4 cm	39
112 30 0330	Beckmann kyreta nosohltnová fig.4; 21,5 cm	Beckmann adenoid curette fig.4; 21,5 cm	39
112 30 0450	Čepel náhradní k adenotomu fig.1	Adenotom blade fig.1	42
112 30 0460	Čepel náhradní k adenotomu fig.2	Adenotom blade fig.2	42
112 30 0470	Čepel náhradní k adenotomu fig.3	Adenotom blade fig.3	42
112 32 0080	Nůž na flegmonu; 17,7 cm	Phegmon knife; 17,7 cm	44
112 33 0020	Baginsky nůž hrtanový; 24,5 cm	Baginsky laryngeal knife; 24,5 cm	44
112 91 0002	Držátko skalpelových čepelek č.3 s měřítkem	Scalpel handle no.3 with measure	27
112 91 0003	Držátko skalpelových čepelek č.3	Scalpel handle no.3	27
112 91 0004	Držátko skalpelových čepelek č.4	Scalpel handle no.4	27, 239
112 91 0005	Držátko skalpelových čepelek č.3l	Scalpel handle no.3l	27
112 91 0006	Držátko skalpelových čepelek č.4l	Scalpel handle no.4l	27

číslo – number	název	item	strana – page
112 91 0007	Držátko skalpelových čepelek č.7	Scalpel handle no.7	27
112 91 0008	Collin držátko skalpelových čepelek č.8	Collin scalpel handle no.8	27
112 91 0010	Čepelka skalpelová fig.10 (baleno po 100 ks)	Pck=100 blades fig.10	28
112 91 0011	Čepelka skalpelová fig.11 (baleno po 100 ks)	Pck=100 blades fig.11	28
112 91 0012	Čepelka skalpelová fig.12 (baleno po 100 ks)	Pck=100 blades fig.12	28
112 91 0013	Čepelka skalpelová fig.13 (baleno po 100 ks)	Pck=100 blades fig.13	28
112 91 0015	Čepelka skalpelová fig.15 (baleno po 100 ks)	Pck=100 blades fig.15	28
112 91 0018	Čepelka skalpelová fig.18 (baleno po 100 ks)	Pck=100 blades fig.18	28
112 91 0019	Čepelka skalpelová fig.19 (baleno po 100 ks)	Pck=100 blades fig.19	28
112 91 0020	Čepelka skalpelová fig.20 (baleno po 100 ks)	Pck=100 blades fig.20	28
112 91 0021	Čepelka skalpelová fig.21 (baleno po 100 ks)	Pck=100 blades fig.21	28
112 91 0022	Čepelka skalpelová fig.22 (baleno po 100 ks)	Pck=100 blades fig.22	28
112 91 0023	Čepelka skalpelová fig.23 (baleno po 100 ks)	Pck=100 blades fig.23	28
112 91 0024	Čepelka skalpelová fig.24 (baleno po 100 ks)	Pck=100 blades fig.24	28
112 91 0025	Čepelka skalpelová fig.12d (baleno po 100 ks)	Pck=100 blades fig.12d	28
112 91 0026	Čepelka skalpelová fig.15c (baleno po 100 ks)	Pck=100 blades fig.15c	28
112 91 0095	St.Clair-Thompson kyreta na mandle fig.1; 21,0 cm	St.Clair-Thompson adenoid curette fig.1; 21,0 cm	40
112 91 0096	St.Clair-Thompson kyreta na mandle fig.2; 21,0 cm	St.Clair-Thompson adenoid curette fig.2; 21,0 cm	40
112 91 0097	St.Clair-Thompson kyreta na mandle fig.3; 21,0 cm	St.Clair-Thompson adenoid curette fig.3; 21,0 cm	40
112 91 0098	St.Clair-Thompson kyreta na mandle fig.4; 21,0 cm	St.Clair-Thompson adenoid curette fig.4; 21,0 cm	40
112 91 0099	Fischer nůž na mandle; 22,5 cm	Fischer tonsil knife; 22,5 cm	43
112 91 0100	Abraham nůž na mandle; 19,0 cm	Abraham tonsil knife; 19,0 cm	43
112 91 0101	Abraham nůž na mandle; 21,0 cm	Abraham tonsil knife; 21,0 cm	43
112 91 0102	Canfield nůž na mandle; 21,0 cm	Canfield tonsil knife; 21,0 cm	43
112 91 0103	Bruenings nůž na mandle; 23,0 cm	Bruenings tonsil knife; 23,0 cm	43
112 91 0104	Douglas nůž na mandle; 21,0 cm	Douglas tonsil instrument; 21,0 cm	43
112 91 0120	Politzer jehla paracentézní; 16,5 cm	Politzer paracentesis needle; 16,5 cm	29
112 91 0121	Politzer jehla paracentézní; 17,0 cm	Politzer paracentesis needle; 17,0 cm	29
112 91 0122	Sprague operační set	Sprague ear operating set	34
112 91 0123	Sprague jehla paracentézní	Sprague paracentesis needle	34
112 91 0124	Sprague nůž	Sprague knife	34
112 91 0125	Sprague lžička ušní	Sprague ear spoon	34
112 91 0126	Sprague smyčka ušní	Sprague ear loop	34
112 91 0127	Sprague háček ušní	Sprague ear hooklet	34
112 91 0128	Sprague pátradlo	Sprague probe	34
112 91 0129	Barbara jehla; 0,3 mm; 25°; 16,0 cm	Barbara needle; 0,3 mm; 25°	30
112 91 0130	Barbara jehla; 0,6 mm; 25°; 16,0 cm	Barbara needle; 0,6 mm; 25°	30
112 91 0131	Barbara jehla; 1,0 mm; 25°; 16,0 cm	Barbara needle; 1,0 mm; 25°	30
112 91 0132	Shambaugh jehla; 0,3 mm; 45°; 16,0 cm	Shambaugh needle; 0,3 mm; 45°	30
112 91 0133	Shambaugh jehla; 0,6 mm; 45°; 16,0 cm	Shambaugh needle; 0,6 mm; 45°	30
112 91 0134	Shambaugh jehla; 1,0 mm; 45°; 16,0 cm	Shambaugh needle; 1,0 mm; 45°	30
112 91 0135	Shambaugh jehla; 1,2 mm; 45°; 16,0 cm	Shambaugh needle; 1,2 mm; 45°	30
112 91 0136	Shambaugh jehla; 1,5 mm; 45°; 16,0 cm	Shambaugh needle; 1,5 mm; 45°	30
112 91 0137	Shambaugh jehla; 2,0 mm; 45°; 16,0 cm	Shambaugh needle; 2,0 mm; 45°	30
112 91 0138	Shambaugh jehla; 2,5 mm; 45°; 16,0 cm	Shambaugh needle; 2,5 mm; 45°	30
112 91 0139	Shambaugh jehla; 0,3 mm; 90°; 16,0 cm	Shambaugh needle; 0,3 mm; 90°	30
112 91 0140	Shambaugh jehla; 0,6 mm; 90°; 16,0 cm	Shambaugh needle; 0,6 mm; 90°	30
112 91 0141	Shambaugh jehla; 1,0 mm; 90°; 16,0 cm	Shambaugh needle; 1,0 mm; 90°	30
112 91 0142	Shambaugh jehla; 1,2 mm; 90°; 16,0 cm	Shambaugh needle; 1,2 mm; 90°	30
112 91 0143	Shambaugh jehla; 1,5 mm; 90°; 16,0 cm	Shambaugh needle; 1,5 mm; 90°	30
112 91 0144	Shambaugh jehla; 2,0 mm; 90°; 16,0 cm	Shambaugh needle; 2,0 mm; 90°	30
112 91 0145	Shambaugh jehla; 2,5 mm; 90°; 16,0 cm	Shambaugh needle; 2,5 mm; 90°	30
112 91 0146	Barbara háček; 0,6 mm; 16,0 cm	Barbara hooklet; 0,6 mm; 16,0 cm	30
112 91 0147	Barbara háček; 1,0 mm; 16,0 cm	Barbara hooklet; 1,0 mm; 16,0 cm	30
112 91 0148	Barbara jehla rovná; 16,0 cm	Barbara needle straight; 16,0 cm	30
112 91 0149	Barbara jehla lomená; 16,0 cm	Barbara needle angular; 16,0 cm	30
112 91 0150	Barbara jehla zahnutá; 16,0 cm	Barbara needle curved; 16,0 cm	30
112 91 0151	Rosen jehla zahnutá; 16,0 cm	Rosen needle curved; 16,0 cm	30
112 91 0152	Jehla nahoru zahnutá; 25°; 0,3 mm	Needle curved upwards; 25°; 0,3 mm	31
112 91 0153	Jehla nahoru zahnutá; 25°; 0,6 mm	Needle curved upwards; 25°; 0,6 mm	31
112 91 0154	Jehla nahoru zahnutá; 25°; 1,0 mm	Needle curved upwards; 25°; 1,0 mm	31
112 91 0155	Jehla dolu zahnutá; 25°; 0,3 mm	Needle curved downwards; 25°; 0,3 mm	31
112 91 0156	Jehla dolu zahnutá; 25°; 0,6 mm	Needle curved downwards; 25°; 0,6 mm	31
112 91 0157	Jehla dolu zahnutá; 25°; 1,0 mm	Needle curved downwards; 25°; 1,0 mm	31
112 91 0158	Jehla nahoru zahnutá; 45°; 0,3 mm	Needle curved upwards; 45°; 0,3 mm	31
112 91 0159	Jehla nahoru zahnutá; 45°; 0,6 mm	Needle curved upwards; 45°; 0,6 mm	31
112 91 0160	Jehla nahoru zahnutá; 45°; 1,0 mm	Needle curved upwards; 45°; 1,0 mm	31
112 91 0161	Jehla dolu zahnutá; 45°; 0,3 mm	Needle curved downwards; 45°; 0,3 mm	31
112 91 0162	Jehla dolu zahnutá; 45°; 0,6 mm	Needle curved downwards; 45°; 0,6 mm	31
112 91 0163	Jehla dolu zahnutá; 45°; 1,0 mm	Needle curved downwards; 45°; 1,0 mm	31

číslo – number	název	item	strana – page
112 91 0164	Jehla nahoru zahnutá; 90°; 0,3 mm	Needle curved upwards; 90°; 0,3 mm	31
112 91 0165	Jehla nahoru zahnutá; 90°; 0,6 mm	Needle curved upwards; 90°; 0,6 mm	31
112 91 0166	Jehla nahoru zahnutá; 90°; 1,0 mm	Needle curved upwards; 90°; 1,0 mm	31
112 91 0167	Jehla dolů zahnutá; 90°; 0,3 mm	Needle curved downwards; 90°; 0,3 mm	31
112 91 0168	Jehla dolů zahnutá; 90°; 0,6 mm	Needle curved downwards; 90°; 0,6 mm	31
112 91 0169	Jehla dolů zahnutá; 90°; 1,0 mm	Needle curved downwards; 90°; 1,0 mm	31
112 91 0170	McGee háček nahoru zahnutý; 0,5 mm	McGee hooklet curved upwards; 0,5 mm	31
112 91 0171	McGee háček nahoru zahnutý; 1,0 mm	McGee hooklet curved upwards; 1,0 mm	31
112 91 0172	McGee háček dolů zahnutý; 0,5 mm	McGee hooklet curved downwards; 0,5 mm	31
112 91 0173	McGee háček dolů zahnutý; 1,0 mm	McGee hooklet curved downwards; 1,0 mm	31
112 91 0174	Barbara jehla rovná	Barbara needle straight	31
112 91 0175	Rosen jehla zahnutá	Rosen needle curved	31
112 91 0176	Rosen nůž ušní; 1,0 mm; 16,0 cm	Rosen knife; 1,0 mm; 16,0 cm	32
112 91 0177	Rosen nůž ušní; 1,4 mm; 16,0 cm	Rosen knife; 1,4 mm; 16,0 cm	32
112 91 0178	Rosen nůž ušní; 1,6 mm; 16,0 cm	Rosen knife; 1,6 mm; 16,0 cm	32
112 91 0179	Rosen nůž ušní; 2,0 mm; 16,0 cm	Rosen knife; 2,0 mm; 16,0 cm	32
112 91 0180	Rosen nůž ušní; 2,6 mm; 16,0 cm	Rosen knife; 2,6 mm; 16,0 cm	32
112 91 0181	Rosen nůž ušní; 2,8 mm; 16,0 cm	Rosen knife; 2,8 mm; 16,0 cm	32
112 91 0182	Rosen nůž ušní; 3,0 mm; 16,0 cm	Rosen knife; 3,0 mm; 16,0 cm	32
112 91 0183	Plester nůž ušní rovný; 16,0 cm	Plester knife straight; 16,0 cm	32
112 91 0184	Plester nůž ušní zahnutý; 16,0 cm	Plester knife curved; 16,0 cm	32
112 91 0185	Plester nůž ušní; 16,0 cm	Plester knife; 16,0 cm	32
112 91 0186	Tabb nůž ušní; 16,0 cm	Tabb knife; 16,0 cm	32
112 91 0187	Schuknecht nůž ušní; 16,0 cm	Schuknecht knife; 16,0 cm	32
112 91 0188	Schuknecht nůž ušní; 16,0 cm	Schuknecht knife; 16,0 cm	32
112 91 0189	Wullstein nůž ušní; 16,0 cm	Wullstein knife; 16,0 cm	32
112 91 0190	Schuknecht nůž ušní; 16,0 cm	Schuknecht knife; 16,0 cm	32
112 91 0251	Joseph nůž nosní rovný fig.1	Joseph knife sharp straight fig.1	36
112 91 0252	Joseph nůž nosní rovný fig.2	Joseph knife sharp straight fig.2	36
112 91 0253	Joseph nůž nosní zahnutý fig.1	Joseph knife sharp curved fig.1	36
112 91 0254	Joseph nůž nosní zahnutý fig.2	Joseph knife sharp curved fig.2	36
112 91 0255	Fomon nůž nosní zahnutý; 16,0 cm	Fomon knife curved; 16,0 cm	36
112 91 0256	Masing nůž nosní; 13,0 cm	Masing knife; 13,0 cm	37
112 91 0257	Cottle nůž nosní; 15,0 cm	Cottle knife; 15,0 cm	37
112 91 0258	Cottle nůž nosní; 15,0 cm	Cottle knife; 15,0 cm	37
112 91 0259	Converse nůž nosní; 16,0 cm	Converse nasal knife; 16,0 cm	37
112 91 0260	Joseph nůž na nosní plastiku tupý; 15,0 cm	Joseph knife for nose plastic surgery; 15,0 cm	37
112 91 0261	Freer "d" nůž na nosní přepážku; 15,0 cm; 20,0 cm	Freer "d" septum knife; 15,0 cm; 20,0 cm	35
112 91 0262	Freer "e" nůž na nosní přepážku; 15,0 cm	Freer "e" septum knife; 15,0 cm	35
112 91 0263	Freer nůž na nosní přepážku; 15,0 cm	Freer septum knife; 15,0 cm	35
112 91 0264	Bruenings nůž nosní; 16,0 cm	Bruenings knife; 16,0 cm	37
112 91 0265	Čepel náhradní k noži nosnímu Bruenings	Spare blade for 112 91 0264	37
112 91 0266	Joseph nůž nosní lomený; 16,5 cm	Joseph knife angled; 16,5 cm	38
112 91 0267	Maltz nůž nosní ohebný; 16,5 cm	Maltz knife malleable; 16,5 cm	38
112 91 0268	Ballenger nůž na nosní přepážku; 3 mm; 20 cm	Ballenger septum swivel knife; 3 mm; 20 cm	36
112 91 0269	Ballenger nůž na nosní přepážku vyhnutý; 3 mm; 20,0 cm	Ballenger septum swivel knife; 3 mm; 20,0 cm	36
112 91 0270	Ballenger nůž na nosní přepážku vyhnutý; 4 mm; 20,0 cm	Ballenger septum swivel knife; 4 mm; 20,0 cm	36
112 91 0271	Ballenger nůž na nosní přepážku vyhnutý; 5 mm; 20,0 cm	Ballenger septum swivel knife; 5 mm; 20,0 cm	36
112 91 0272	Beckmann kyreta nosohltanová fig. 5; 22,0 cm	Beckmann adenoid curette straight; 22,0 cm	39
112 91 0273	Beckmann kyreta nosohltanová fig. 6; 22,0 cm	Beckmann adenoid curette straight; 22,0 cm	39
112 91 0274	Beckmann kyreta na mandle zahnutá fig.1; 22,0 cm	Beckmann adenoid curette curved fig.1; 22,0 cm	39
112 91 0275	Beckmann kyreta na mandle zahnutá fig.2; 22,0 cm	Beckmann adenoid curette curved fig.2; 22,0 cm	39
112 91 0276	Beckmann kyreta na mandle zahnutá fig.3; 22,0 cm	Beckmann adenoid curette curved fig.3; 22,0 cm	39
112 91 0277	Beckmann kyreta na mandle zahnutá fig.4; 22,0 cm	Beckmann adenoid curette curved fig.4; 22,0 cm	39
112 91 0278	Beckmann kyreta na mandle zahnutá fig.5; 22,0 cm	Beckmann adenoid curette curved fig.5; 22,0 cm	39
112 91 0279	Beckmann kyreta na mandle zahnutá fig.6; 22,0 cm	Beckmann adenoid curette curved fig.6; 22,0 cm	39
112 91 0280	Barnhill kyreta na mandle fig.1; 22,0 cm	Barnhill adenoid curette fig.1; 22,0 cm	40
112 91 0281	Barnhill kyreta na mandle fig.2; 22,0 cm	Barnhill adenoid curette fig.2; 22,0 cm	40
112 91 0282	Barnhill kyreta na mandle fig.3; 22,0 cm	Barnhill adenoid curette fig.3; 22,0 cm	40
112 91 0283	Barnhill kyreta na mandle fig.4; 22,0 cm	Barnhill adenoid curette fig.4; 22,0 cm	40
112 91 0284	La Force adenotom perforovaný fig.1; 25 cm	La Force adenotom perforated fig.1; 25 cm	41
112 91 0285	La Force adenotom perforovaný fig.2; 25 cm	La Force adenotom perforated fig.2; 25 cm	41
112 91 0286	La Force adenotom perforovaný fig.3; 25 cm	La Force adenotom perforated fig.3; 25 cm	41
112 91 0287	La Force čepel adenotomu perforovaná fig.1	La Force spare blades perforated fig.1	41
112 91 0288	La Force čepel adenotomu perforovaná fig.2	La Force spare blades perforated fig.2	41
112 91 0289	La Force čepel adenotomu perforovaná fig.3	La Force spare blades perforated fig.3	41
112 91 0290	La Force adenotom fig. 1; 25,0 cm	La Force adenotom; 25,0 cm	41
112 91 0291	La Force adenotom fig. 2; 25,0 cm	La Force adenotom; 25,0 cm	41
112 91 0292	La Force adenotom fig. 3; 25,0 cm	La Force adenotom; 25,0 cm	41
112 91 0293	Čepel náhradní pro La Force fig.1	Spare blade for La Force	41

číslo – number	název	item	strana – page
112 91 0294	Čepel náhradní pro La Force fig.2	Spare blade for La Force	41
112 91 0295	Čepel náhradní pro La Force fig.3	Spare blade for La Force	41
113	NŮŽKY	SCISSORS	
113 08 0010	Nůžky chirurgické rovné hrotnaté; 13,0 cm	Standard operating scissors; 13,0 cm	47
113 08 0020	Nůžky chirurgické rovné hrotnaté; 15,0 cm	Standard operating scissors; 15,0 cm	47
113 08 0040	Nůžky chirurgické rovné hrotnaté; 18,5 cm	Standard operating scissors; 18,5 cm	47
113 08 0110	Nůžky chirurgické rovné hrotnatotupé; 13,0 cm	Standard operating scissors; 13,0 cm	47
113 08 0120	Nůžky chirurgické rovné hrotnatotupé; 15,0 cm	Standard operating scissors; 15,0 cm	47
113 08 0140	Nůžky chirurgické rovné hrotnatotupé; 18,5 cm	Standard operating scissors; 18,5 cm	47
113 08 0210	Nůžky chirurgické rovné tupé; 13,0 cm	Standard operating scissors; 13,0 cm	48
113 08 0220	Nůžky chirurgické rovné tupé; 15,0 cm	Standard operating scissors; 15,0 cm	48
113 08 0240	Nůžky chirurgické rovné tupé; 18,5 cm	Standard operating scissors; 18,5 cm	48
113 08 0310	Nůžky chirurgické zahnuté hrotnaté; 13,0 cm	Standard operating scissors; 13,0 cm	47
113 08 0320	Nůžky chirurgické zahnuté hrotnaté; 15,0 cm	Standard operating scissors; 15,0 cm	47
113 08 0340	Nůžky chirurgické zahnuté hrotnaté; 18,5 cm	Standard operating scissors; 18,5 cm	47
113 08 0410	Nůžky chirurgické zahnuté hrotnatotupé; 13,0 cm	Standard operating scissors; 13,0 cm	47
113 08 0420	Nůžky chirurgické zahnuté hrotnatotupé; 15,0 cm	Standard operating scissors; 15,0 cm	47
113 08 0440	Nůžky chirurgické zahnuté hrotnatotupé; 18,5 cm	Standard operating scissors; 18,5 cm	47
113 08 0510	Nůžky chirurgické zahnuté tupé; 13,0 cm	Standard operating scissors; 13,0 cm	48
113 08 0520	Nůžky chirurgické zahnuté tupé; 15,0 cm	Standard operating scissors; 15,0 cm	48
113 08 0540	Nůžky chirurgické zahnuté tupé; 18,5 cm	Standard operating scissors; 18,5 cm	48
113 08 0700	Metzenbaum nůžky preparační zahnuté; 14,0 cm	Metzenbaum dissecting scissors; 14,0 cm	49
113 08 0830	Nůžky preparační rovné extra silné; 17,0 cm	Dissecting scissors; 17,0 cm	50
113 08 0840	Nůžky preparační zahnuté extra silné; 17,0 cm	Dissecting scissors; 17,0 cm	50
113 08 0880	Nůžky preparační rovné jemné; 18,5 cm	Dissecting scissors; 18,5 cm	51
113 08 0890	Nůžky preparační zahnuté jemné; 18,5 cm	Dissecting scissors; 18,5 cm	51
113 08 0930	Nůžky preparační rovné; 17,0 cm	Dissecting scissors; 17,0 cm	51
113 08 0940	Nůžky preparační zahnuté; 17,0 cm	Dissecting scissors; 17,0 cm	51
113 10 0110	Nůžky preparační dětské tupé rovné; 18,5 cm	Dissecting scissors; 18,5 cm	52
113 10 0120	Nůžky preparační dětské tupé zahnuté; 18,5 cm	Dissecting scissors; 18,5 cm	52
113 10 0210	Nůžky preparační tupé rovné jemné; 18,5 cm	Dissecting scissors; 18,5 cm	52
113 10 0220	Nůžky preparační tupé zahnuté jemné; 18,5 cm	Dissecting scissors; 18,5 cm	52
113 12 0010	Nůžky preparační s oboustraným ostřím rovné; 12,0 cm	Dissecting scissors; 12,0 cm	53
113 12 0020	Nůžky preparační s oboustraným ostřím zahnuté; 12,0 cm	Dissecting scissors; 12,0 cm	53
113 30 0010	Heymann nůžky nosní lomené; 18,0 cm	Heymann nasal scissors; 18,0 cm	53
113 32 0010	Prince nůžky na mandle; 18,5 cm	Prince tonsil scissors; 18,5 cm	53
113 38 0010	Nůžky oční rovné hrotnaté; 10,0 cm	Eye scissors; 10,0 cm	55
113 38 0020	Nůžky oční rovné hrotnatotupé; 10,0 cm	Eye scissors; 10,0 cm	55
113 38 0030	Nůžky oční rovné tupé; 10,0 cm	Eye scissors; 10,0 cm	55
113 38 0040	Nůžky oční zahnuté hrotnaté; 10,0 cm	Eye scissors; 10,0 cm	55
113 38 0050	Nůžky oční zahnuté hrotnatotupé; 10,0 cm	Eye scissors; 10,0 cm	55
113 38 0060	Nůžky oční zahnuté tupé; 10,0 cm	Eye scissors; 10,0 cm	55
113 38 0071	Nůžky oční rovné hrotnaté; 11,5 cm	Eye scissors; 11,5 cm	55
113 38 0081	Nůžky oční rovné tupé; 11,5 cm	Eye scissors; 11,5 cm	55
113 38 0091	Nůžky oční zahnuté hrotnaté; 11,5 cm	Eye scissors; 11,5 cm	55
113 38 0100	Nůžky oční zahnuté hrotnatotupé; 11,5 cm	Eye scissors; 11,5 cm	55
113 38 0150	Nůžky oční rovné hrotnatotupé; 11,5 cm	Eye scissors; 11,5 cm	55
113 38 0210	Nůžky oční lomené hrotnaté; 10,5 cm	Eye scissors; 10,5 cm	55
113 38 0260	Nůžky oční lomené tupé; 10,5 cm	Eye scissors; 10,5 cm	55
113 38 0311	Nůžky oční stranou zahnuté hrotnaté; 11,5 cm	Eye scissors; 11,5 cm	55
113 91 0002	Nůžky chirurgické tupé rovné; 11,5 cm	Standard operating scissors; 11,5 cm	48
113 91 0006	Nůžky chirurgické tupé rovné; 16,5 cm	Standard operating scissors; 16,5 cm	48
113 91 0011	Nůžky chirurgické tupé zahnuté; 11,5 cm	Standard operating scissors; 11,5 cm	48
113 91 0015	Nůžky chirurgické tupé zahnuté; 16,5 cm	Standard operating scissors; 16,5 cm	48
113 91 0020	Nůžky chirurgické hrotnatotupé rovné; 11,5 cm	Standard operating scissors; 11,5 cm	47
113 91 0026	Nůžky chirurgické hrotnatotupé rovné; 16,5 cm	Standard operating scissors; 16,5 cm	47
113 91 0031	Nůžky chirurgické hrotnatotupé zahnuté; 11,5 cm	Standard operating scissors; 11,5 cm	47
113 91 0037	Nůžky chirurgické hrotnatotupé zahnuté; 16,5 cm	Standard operating scissors; 16,5 cm	47
113 91 0042	Nůžky chirurgické hrotnaté rovné; 11,5 cm	Standard operating scissors; 11,5 cm	47
113 91 0046	Nůžky chirurgické hrotnaté rovné; 16,5 cm	Standard operating scissors; 16,5 cm	47
113 91 0051	Nůžky chirurgické hrotnaté zahnuté; 11,5 cm	Standard operating scissors; 11,5 cm	47
113 91 0055	Nůžky chirurgické hrotnaté zahnuté; 16,5 cm	Standard operating scissors; 16,5 cm	47
113 91 0083	Mayo nůžky preparační tupé rovné; 14,5 cm	Mayo dissecting scissors; 14,5 cm	50
113 91 0087	Mayo nůžky preparační tupé rovné; 23,0 cm	Mayo dissecting scissors; 23,0 cm	50
113 91 0090	Mayo nůžky preparační tupé zahnuté; 14,5 cm	Mayo dissecting scissors; 14,5 cm	50
113 91 0094	Mayo nůžky preparační tupé zahnuté; 23,0 cm	Mayo dissecting scissors; 23,0 cm	50
113 91 0097	Mayo-Stille nůžky preparační tupé rovné; 15,0 cm	Mayo-Stille dissecting scissors; 15,0 cm	50
113 91 0098	Mayo-Stille nůžky preparační tupé rovné; 17,0 cm	Mayo-Stille dissecting scissors; 17,0 cm	50
113 91 0101	Mayo-Stille nůžky preparační tupé zahnuté; 15,0 cm	Mayo-Stille dissecting scissors; 15,0 cm	50
113 91 0102	Mayo-Stille nůžky preparační tupé zahnuté; 17,0 cm	Mayo-Stille dissecting scissors; 17,0 cm	50

číslo – number	název	item	strana – page
113 91 0143	Metzenbaum-Nelson nůžky prep. tupé rovné; 18,0 cm	Metzenbaum-Nelson scissors; 18,0 cm	49
113 91 0152	Metzenbaum-Nelson nůžky preparační rovné jemné; 18,0 cm	Metzenbaum-Nelson dissecting scissors; 18,0 cm	49
113 91 0189	Metzenbaum-Delicate nůžky prep. tupé zahnuté; 28,0 cm	Metzenbaum-Delicate scissors; 28,0 cm	49
113 91 0195	Metzenbaum-Delicate nůžky prep. tupé zahnuté; 18,0 cm	Metzenbaum-Delicate scissors; 18,0 cm	49
113 91 0215	Lexer nůžky preparační rovné; 16,0 cm	Lexer dissecting scissors; 16,0 cm	52
113 91 0216	Lexer nůžky preparační zahnuté; 16,0 cm	Lexer dissecting scissors; 16,0 cm	52
113 91 0217	Fomon nůžky preparační zahnuté; 13,5 cm	Fomon dissecting scissors; 13,5 cm	51
113 91 0218	Thorek nůžky preparační zahnuté; 19,0 cm	Thorek dissecting scissors; 19,0 cm	51
113 91 0219	Lexer-Baby nůžky preparační rovné; 10,0 cm	Lexer-Baby dissecting scissors; 10,0 cm	51
113 91 0220	Lexer-Baby nůžky preparační zahnuté; 10,0 cm	Lexer-Baby dissecting scissors; 10,0 cm	51
113 91 0221	Sanvenero nůžky preparační hrotnaté rovné; 14,0 cm	Sanvenero dissecting scissors; 14,0 cm	53
113 91 0222	Sanvenero nůžky preparační hrotnaté zahnuté; 14,0 cm	Sanvenero dissecting scissors; 14,0 cm	53
113 91 0229	Kilner nůžky preparační zahnuté; 12,0 cm	Kilner dissecting scissors; 12,0 cm	52
113 91 0230	Kilner nůžky preparační zahnuté; 15,0 cm	Kilner dissecting scissors; 15,0 cm	52
113 91 0233	Reynolds nůžky preparační ostré rovné; 15,0 cm	Reynolds dissecting scissors; 15,0 cm	53
113 91 0235	Reynolds nůžky preparační ostré zahnuté; 15,0 cm	Reynolds dissecting scissors; 15,0 cm	53
113 91 0311	Fomon nůžky nosní tupé; 13,5 cm	Fomon nasal scissors; 13,5 cm	54
113 91 0313	Cottle nůžky nosní tupé; 16,0 cm	Cottle nasal scissors; 16,0 cm	54
113 91 0379	Stevens nůžky oční hrotnaté rovné; 10,5 cm	Stevens tenotomy scissors; 10,5 cm	54
113 91 0380	Stevens nůžky oční hrotnaté rovné; 11,5 cm	Stevens tenotomy scissors; 11,5 cm	54
113 91 0381	Stevens nůžky oční hrotnaté zahnuté; 10,5 cm	Stevens tenotomy scissors; 10,5 cm	54
113 91 0382	Stevens nůžky oční hrotnaté zahnuté; 11,5 cm	Stevens tenotomy scissors; 11,5 cm	54
113 91 0383	Stevens nůžky oční tupé rovné; 10,5 cm	Stevens tenotomy scissors; 10,5 cm	54
113 91 0384	Stevens nůžky oční tupé rovné; 11,5 cm	Stevens tenotomy scissors; 11,5 cm	54
113 91 0385	Stevens nůžky oční tupé zahnuté; 10,5 cm	Stevens tenotomy scissors; 10,5 cm	54
113 91 0386	Stevens nůžky oční tupé zahnuté; 11,5 cm	Stevens tenotomy scissors; 11,5 cm	54
113 91 0387	Nůžky oční hrotnaté rovné; 10,0 cm	Eye scissors; 10,0 cm	56
113 91 0388	Nůžky oční hrotnaté zahnuté; 10,0 cm	Eye scissors; 10,0 cm	56
113 91 0389	Nůžky oční tupé rovné; 10,0 cm	Eye scissors; 10,0 cm	56
113 91 0390	Nůžky oční tupé zahnuté; 10,0 cm	Eye scissors; 10,0 cm	56
113 91 0393	Nůžky oční rovné; 9,5 cm	Eye scissors; 9,5 cm	56
113 91 0394	Nůžky oční rovné; 9,5 cm	Eye scissors; 9,5 cm	56
113 91 0395	Nůžky oční rovné; 9,5 cm	Eye scissors; 9,5 cm	56
113 91 0396	Nůžky oční zahnuté; 9,5 cm	Eye scissors; 9,5 cm	56
113 91 0399	Spencer nůžky pro ligaturu; 9,0 cm	Spencer ligature scissors; 9,0 cm	56
113 91 0400	Spencer nůžky pro ligaturu; 10,5 cm	Spencer ligature scissors; 10,5 cm	56
113 91 0403	Littauer nůžky pro ligaturu; 14,0 cm	Littauer ligature scissors; 14,0 cm	56
113 91 0408	Heath nůžky pro ligaturu; 15,0 cm	Heath ligature scissors; 15,0 cm	56
113 91 0411	Northbent nůžky pro ligaturu zahnuté; 12,5 cm	Northbent ligature scissors; 12,5 cm	56
113 91 0601	Mayo nůžky tupé rovné tvrdokovové; 14,5 cm	Mayo dissecting scissors tuc; 14,5 cm	63
113 91 0602	Mayo nůžky tupé rovné tvrdokovové; 17,0 cm	Mayo dissecting scissors tuc; 17,0 cm	63
113 91 0603	Mayo nůžky tupé rovné tvrdokovové; 23,0 cm	Mayo dissecting scissors tuc; 23,0 cm	63
113 91 0604	Mayo nůžky tupé zahnuté tvrdokovové; 14,5 cm	Mayo dissecting scissors tuc; 14,5 cm	63
113 91 0605	Mayo nůžky tupé zahnuté tvrdokovové; 17,0 cm	Mayo dissecting scissors tuc; 17,0 cm	63
113 91 0606	Mayo nůžky tupé zahnuté tvrdokovové; 23,0 cm	Mayo dissecting scissors tuc; 23,0 cm	63
113 91 0609	Mayo-Stille nůžky tupé rovné tvrdokovové; 15,0 cm	Mayo-Stille scissors tuc; 15,0 cm	63
113 91 0610	Mayo-Stille nůžky tupé rovné tvrdokovové; 17,0 cm	Mayo-Stille scissors tuc; 17,0 cm	63
113 91 0611	Mayo-Stille nůžky tupé zahnuté tvrdokovové; 15,0 cm	Mayo-Stille scissors tuc; 15,0 cm	63
113 91 0612	Mayo-Stille nůžky tupé zahnuté tvrdokovové; 17,0 cm	Mayo-Stille scissors tuc; 17,0 cm	63
113 91 0617	Metzenbaum nůžky tupé rovné tvrdokovové; 11,5 cm	Metzenbaum scissors tuc; 11,5 cm	64
113 91 0618	Metzenbaum nůžky tupé zahnuté tvrdokovové; 11,5 cm	Metzenbaum scissors tuc; 11,5 cm	64
113 91 0621	Metzenbaum nůžky tupé rovné tvrdokovové; 18,0 cm	Metzenbaum scissors tuc; 18,0 cm	65
113 91 0622	Metzenbaum nůžky tupé rovné tvrdokovové; 20,0 cm	Metzenbaum scissors tuc; 20,0 cm	65
113 91 0623	Metzenbaum nůžky tupé rovné tvrdokovové; 23,0 cm	Metzenbaum scissors tuc; 23,0 cm	65
113 91 0624	Metzenbaum nůžky tupé rovné tvrdokovové; 25,0 cm	Metzenbaum scissors tuc; 25,0 cm	65
113 91 0625	Metzenbaum nůžky tupé rovné tvrdokovové; 28,0 cm	Metzenbaum scissors tuc; 28,0 cm	65
113 91 0627	Metzenbaum nůžky tupé zahnuté tvrdokovové; 18,0 cm	Metzenbaum scissors tuc; 18,0 cm	65
113 91 0628	Metzenbaum nůžky tupé zahnuté tvrdokovové; 20,0 cm	Metzenbaum scissors tuc; 20,0 cm	65
113 91 0629	Metzenbaum nůžky tupé zahnuté tvrdokovové; 23,0 cm	Metzenbaum scissors tuc; 23,0 cm	65
113 91 0630	Metzenbaum nůžky tupé zahnuté tvrdokovové; 25,0 cm	Metzenbaum scissors tuc; 25,0 cm	65
113 91 0631	Metzenbaum nůžky tupé zahnuté tvrdokovové; 28,0 cm	Metzenbaum scissors tuc; 28,0 cm	65
113 91 0639	Lexer nůžky rovné tvrdokovové; 16,0 cm	Lexer scissors tuc; 16,0 cm	64
113 91 0640	Lexer nůžky zahnuté tvrdokovové; 16,0 cm	Lexer scissors tuc; 16,0 cm	64
113 91 0645	Metzenbaum-Delicate nůžky tupé rovné tvrdok.; 18,0 cm	Metzenbaum-Delicate scissors tuc; 18,0 cm	66
113 91 0646	Metzenbaum-Delicate nůžky tupé rovné tvrdok.; 20,0 cm	Metzenbaum-Delicate scissors tuc; 20,0 cm	66
113 91 0647	Metzenbaum-Delicate nůžky tupé rovné tvrdok.; 23,0 cm	Metzenbaum-Delicate scissors tuc; 23,0 cm	66
113 91 0648	Metzenbaum-Delicate nůžky tupé rovné tvrdok.; 25,0 cm	Metzenbaum-Delicate scissors tuc; 25,0 cm	66
113 91 0649	Metzenbaum-Delicate nůžky tupé rovné tvrdok.; 28,0 cm	Metzenbaum-Delicate scissors tuc; 28,0 cm	66
113 91 0650	Metzenbaum-Delicate nůžky tupé zahnuté tvrdok.; 18,0 cm	Metzenbaum-Delicate scissors tuc; 18,0 cm	66
113 91 0651	Metzenbaum-Delicate nůžky tupé zahnuté tvrdok.; 20,0 cm	Metzenbaum-Delicate scissors tuc; 20,0 cm	66

číslo – number	název	item	strana – page
113 91 0652	Metzenbaum-Delicate nůžky tupé Zahn. tvrdok.; 23,0 cm	Metzenbaum-Delicate scissors tuc; 23,0 cm	66
113 91 0653	Metzenbaum-Delicate nůžky tupé Zahn. tvrdok.; 25,0 cm	Metzenbaum-Delicate scissors tuc; 25,0 cm	66
113 91 0654	Metzenbaum-Delicate nůžky tupé Zahn. tvrdok.; 28,0 cm	Metzenbaum-Delicate scissors tuc; 28,0 cm	66
113 91 0672	Nůžky mikro rovné; 25,0 cm	Endolaryngeal micro scissors straight; 25,0 cm	57
113 91 0673	Nůžky mikro zahnuté nahoru; 25,0 cm	Endolaryngeal micro scissors curved up; 25,0 cm	57
113 91 0674	Nůžky mikro zahnuté vpravo; 25,0 cm	Endolaryngeal micro scissors curved left; 25,0 cm	57
113 91 0675	Nůžky mikro zahnuté vlevo; 25,0 cm	Endolaryngeal micro scissors curved right; 25,0 cm	57
113 91 0676	Killian nůžky na septum; 20,0 cm	Killian septum scissors; 20,0 cm	57
113 91 0677	Bellucci nůžky ušní rovné; 4,0 mm; 8,0 cm	Bellucci scissors straight; 4,0 mm; 8,0 cm	58
113 91 0678	Bellucci nůžky ušní zahnuté nahoru; 4,0 mm; 8,0 cm	Bellucci scissors curved up; 4,0 mm; 8,0 cm	58
113 91 0679	Bellucci nůžky ušní zahnuté vlevo; 4,0 mm; 8,0 cm	Bellucci scissors curved left; 4,0 mm; 8,0 cm	58
113 91 0680	Bellucci nůžky ušní zahnuté vpravo; 4,0 mm; 8,0 cm	Bellucci scissors curved right; 4,0 mm; 8,0 cm	58
113 91 0681	Wullstein nůžky ušní; 8,0 cm	Wullstein ear-scissors; 8,0 cm	58
113 91 0682	Wullstein nůžky ušní; 19,0 cm	Wullstein ear-scissors; 19,0 cm	58
113 91 0683	Cottle nůžky tvrdokovové lomené; 16,0 cm	Cottle scissors angled tuc; 16,0 cm	64
113 91 0684	Hough nůžky nosní lomené; 13,0 cm	Hough nasal scissors angled; 13,0 cm	54
113 91 0685	Stille nůžky micro super cut rovné; 10 cm	Stille scissors micro super cut straight; 10 cm	59
113 91 0686	Stille nůžky micro super cut zahnuté; 10 cm	Stille scissors micro super cut bent; 10 cm	59
113 91 0687	Jabaley-Stille nůžky micro super cut rovné; 12 cm	Jabaley-Stille scissors micro super cut straight; 12 cm	59
113 91 0688	Jabaley-Stille nůžky micro super cut zahnuté; 12 cm	Jabaley-Stille scissors micro super cut bent; 12 cm	59
113 91 0689	Stevens nůžky micro super cut rovné; 12,5 cm	Stevens scissors micro super cut straight; 12,5 cm	59
113 91 0690	Stevens nůžky micro super cut zahnuté; 12,5 cm	Stevens scissors micro super cut bent; 12,5 cm	59
113 91 0691	Lister (bandage) nůžky micro super cut zahnuté; 14 cm	Lister (bandage) scissors micro super cut bent; 14 cm	59
113 91 0692	Mayo-Stille nůžky micro super cut; 15 cm	Mayo-Stille scissors micro super cut; 15 cm	60
113 91 0693	Mayo-Stille nůžky micro super cut zahnuté; 15 cm	Mayo-Stille scissors micro super cut bent; 15 cm	60
113 91 0694	Stille-Mayo nůžky micro super cut; 15 cm	Stille-Mayo scissors micro super cut; 15 cm	60
113 91 0695	Stille-Mayo nůžky micro super cut; 17 cm	Stille-Mayo scissors micro super cut; 17 cm	60
113 91 0696	Stille-Mayo nůžky micro super cut zahnuté; 15 cm	Stille-Mayo scissors micro super cut bent; 15 cm	60
113 91 0697	Stille-Mayo nůžky micro super cut zahnuté; 17 cm	Stille-Mayo scissors micro super cut bent; 17 cm	60
113 91 0698	Mayo-Harrington nůžky micro super cut; 23 cm	Mayo-Harrington scissors micro super cut; 23 cm	60
113 91 0699	Mayo-Harrington nůžky micro super cut; 20 cm	Mayo-Harrington scissors micro super cut; 20 cm	60
113 91 0700	Stille-Rangell nůžky micro super cut zahnuté; 12,5 cm	Stille-Rangell scissors micro super cut bent; 12,5 cm	60
113 91 0701	Stille-Rangell nůžky micro super cut zahnuté; 15 cm	Stille-Rangell scissors micro super cut bent; 15 cm	60
113 91 0702	Stille-Rangell nůžky micro super cut zahnuté; 18 cm	Stille-Rangell scissors micro super cut bent; 18 cm	60
113 91 0703	Stille-Rangell nůžky micro super cut zahnuté; 20 cm	Stille-Rangell scissors micro super cut bent; 20 cm	60
113 91 0704	Stille-Rangell nůžky micro super cut zahnuté; 23 cm	Stille-Rangell scissors micro super cut bent; 23 cm	60
113 91 0705	Metzenbaum nůžky micro super cut; 15 cm	Metzenbaum scissors micro super cut; 15 cm	61
113 91 0706	Metzenbaum nůžky micro super cut; 18 cm	Metzenbaum scissors micro super cut; 18 cm	61
113 91 0707	Metzenbaum nůžky micro super cut; 20 cm	Metzenbaum scissors micro super cut; 20 cm	61
113 91 0708	Metzenbaum nůžky micro super cut; 23 cm	Metzenbaum scissors micro super cut; 23 cm	61
113 91 0709	Metzenbaum nůžky micro super cut; 26 cm	Metzenbaum scissors micro super cut; 26 cm	61
113 91 0710	Metzenbaum nůžky micro super cut zahnuté; 15 cm	Metzenbaum scissors micro super cut bent; 15 cm	61
113 91 0711	Metzenbaum nůžky micro super cut zahnuté; 18 cm	Metzenbaum scissors micro super cut bent; 18 cm	61
113 91 0712	Metzenbaum nůžky micro super cut zahnuté; 20 cm	Metzenbaum scissors micro super cut bent; 20 cm	61
113 91 0713	Metzenbaum nůžky micro super cut zahnuté; 23 cm	Metzenbaum scissors micro super cut bent; 23 cm	61
113 91 0714	Metzenbaum nůžky micro super cut zahnuté; 26 cm	Metzenbaum scissors micro super cut bent; 26 cm	61
113 91 0715	Baby Metzenbaum nůžky micro super cut rovné; 12,5 cm	Baby Metzenbaum scissors micro super cut straight; 12,5 cm	61
113 91 0716	Baby Metzenbaum nůžky micro super cut zahnuté; 12,5 cm	Baby Metzenbaum scissors micro super cut bent; 12,5 cm	61
113 91 0717	Iris nůžky micro super cut rovné; 11,5 cm	Iris scissors micro super cut straight; 11,5 cm	62
113 91 0718	Iris nůžky micro super cut zahnuté; 11,5 cm	Iris scissors micro super cut bent; 11,5 cm	62
113 91 0719	Iris nůžky micro super cut rovné TC; 11,5 cm	Iris scissors micro super cut straight TC; 11,5 cm	62
113 91 0720	Iris nůžky micro super cut zahnuté TC; 11,5 cm	Iris scissors micro super cut bent TC; 11,5 cm	62
113 91 0721	La Grange nůžky micro super cut; 11,5 cm	La Grange scissors micro super cut; 11,5 cm	62
113 91 0722	La Grange nůžky micro super cut; 11,5 cm	La Grange scissors micro super cut; 11,5 cm	62
114	PINZETY	FORCEPS	
114 08 0030	Pinzeta anatomická; 16,0 cm	Dressing forceps; 16,0 cm	69
114 08 0090	Standard pinzeta anatomická hladká; 14,5 cm	Standard dressing forceps smooth; 14,5 cm	69
114 08 0101	Pinzeta anatomická rovná jemná matovaná; 14,5 cm	Dressing forceps; 14,5 cm	69
114 08 0231	Pinzeta anatomická velmi jemná matovaná; 14,5 cm	Dressing forceps; 14,5 cm	69
114 08 0381	Pinzeta chirurgická matovaná; 1×2 zuby; 14,5 cm	Tissue forceps; 1×2 teeth; 14,5 cm	70
114 08 0430	Pinzeta chirurgická jemná; 1×2 zuby; 16,0 cm	Tissue forceps; 1×2 teeth; 16,0 cm	70
114 08 0530	Pinzeta chirurgická velmi jemná; 1×2 zuby; 14,5 cm	Tissue forceps; 1×2 teeth; 14,5 cm	71
114 08 0620	Pinzeta chirurgická; 3×4 zuby; 14,0 cm	Tissue forceps; 3×4 teeth; 14,0 cm	71
114 08 0660	Pinzeta chirurgická; 4×5 zubů; 14,0 cm	Tissue forceps; 4×5 teeth; 14,0 cm	71
114 08 1350	Pinzeta anatom. rovná s prodlouž. perem mat.; 14,5 cm	Dressing forceps; 14,5 cm	69
114 08 1470	Pinzeta bipolární bajonetová; 1,2 mm; 25,5 cm	Bipolar forceps bay-shaped; 1,2 mm; 25,5 cm	76
114 08 1480	Pinzeta bipolární bajonetová; 0,7 mm; 25,5 cm	Bipolar forceps bay-shaped; 0,7 mm; 25,5 cm	76
114 08 1490	Pinzeta bipolární bajonetová; 2,0 mm; 25,5 cm	Bipolar forceps bay-shaped; 2,0 mm; 25,5 cm	76
114 08 1500	Pinzeta bipolární rovná; 2,0 mm; 19,5 cm	Bipolar forceps; 2,0 mm; 19,5 cm	76
114 08 1510	Pinzeta bipolární rovná; 1,2 mm; 19,5 cm	Bipolar forceps; 1,2 mm; 19,5 cm	76

číslo – number	název	item	strana – page
114 08 1530	Pinzeta bipolární zahnutá; 2,0 mm; 19,3 cm	Bipolar forceps; 2,0 mm; 19,3 cm	76
114 08 1540	Pinzeta bipolární zahnutá; 1,2 mm; 19,3 cm	Bipolar forceps; 1,2 mm; 19,3 cm	76
114 08 1560	Pinzeta bipolární rovná; 2,0 mm; 16,5 cm	Bipolar forceps; 2,0 mm; 16,5 cm	76
114 08 1570	Pinzeta bipolární rovná; 1,2 mm; 16,5 cm	Bipolar forceps; 1,2 mm; 16,5 cm	76
114 08 1580	Pinzeta bipolární rovná; 0,7 mm; 16,5 cm	Bipolar forceps; 0,7 mm; 16,5 cm	76
114 08 1690	Pinzeta bipolární zahnutá; 2,0 mm; 16,3 cm	Bipolar forceps; 2,0 mm; 16,3 cm	76
114 08 1700	Pinzeta bipolární zahnutá; 1,2 mm; 16,3 cm	Bipolar forceps; 1,2 mm; 16,3 cm	76
114 08 1710	Pinzeta bipolární zahnutá; 0,7 mm; 16,3 cm	Bipolar forceps; 0,7 mm; 16,3 cm	76
114 08 1720	Pinzeta bipolární rovná; 0,7 mm; 11,5 cm	Bipolar forceps; 0,7 mm; 11,5 cm	76
114 08 1730	Pinzeta bipolární rovná; 0,4 mm; 11,5 cm	Bipolar forceps; 0,4 mm; 11,5 cm	76
114 08 1750	Pinzeta bipolární zahnutá; 0,7 mm; 11,3 cm	Bipolar forceps; 0,7 mm; 11,3 cm	76
114 08 1760	Pinzeta bipolární zahnutá; 0,4 mm; 11,3 cm	Bipolar forceps; 0,4 mm; 11,3 cm	76
114 12 0030	Pinzeta na plastiku šicí; 3×4 zuby; 10,8 cm	Suturing forceps; 3×4 teeth; 10,8 cm	71
114 29 0010	Troeltsch pinzeta ušní jemná; 11,0 cm	Troeltsch ear forceps; 11,0 cm	75
114 29 0020	Troeltsch pinzeta ušní; 11,0 cm	Troeltsch ear forceps; 11,0 cm	75
114 29 0030	Lucae pinzeta ušní bajonetová anatomická; 14,5 cm	Lucae ear anatomical forceps; 14,5 cm	75
114 30 0010	Troeltsch pinzeta nosní jemná; 16,0 cm	Troeltsch nasal forceps; 16,0 cm	75
114 30 0020	Troeltsch pinzeta nosní; 18,0 cm	Troeltsch nasal forceps; 18,0 cm	75
114 30 0040	Pinzeta bajonetová anatomická; 18,0 cm	Anatomical forceps; 18,0 cm	75
114 32 0010	Maršik pinzeta na mandle; 22,8 cm	Maršik tonsil forceps; 22,8 cm	75
114 38 0350	Graefe pinzeta fixační; 11,0 cm	Graefe fixation forceps; 11,0 cm	74
114 38 0360	Graefe pinzeta fixační s uzávěrem s perem; 11,0 cm	Graefe fixation forceps; 11,0 cm	74
114 38 0370	Elschnig pinzeta fixační; 10,5 cm	Elschnig fixatin forceps; 10,5 cm	74
114 38 0860	Pinzeta na rohovku šicí rovná; 10,0 cm	Corneal suturing forceps; 10,0 cm	74
114 38 0870	Pinzeta na rohovku zahnutá; 10,0 cm	Corneal suturing forceps; 10,0 cm	74
114 91 0003	Pinzeta anatomická rovná; 13,0 cm	Standard dressing forceps; 13,0 cm	239
114 91 0004	Pinzeta anatomická rovná; 14,5 cm	Standard dressing forceps; 14,5 cm	69
114 91 0006	Pinzeta anatomická rovná; 18,0 cm	Standard dressing forceps; 18,0 cm	69
114 91 0012	Pinzeta chirurgická rovná; 1×2 zuby; 13,0 cm	Standard tissue forceps; 1×2 teeth; 13,0 cm	239
114 91 0015	Pinzeta chirurgická rovná; 1×2 zuby; 18,0 cm	Standard tissue forceps; 1×2 teeth; 18,0 cm	70
114 91 0020	Pinzeta chirurgická rovná; 2×3 zuby; 14,5 cm	Tissue forceps; 2×3 teeth; 14,5 cm	70
114 91 0021	Pinzeta chirurgická rovná; 2×3 zuby; 16,0 cm	Tissue forceps; 2×3 teeth; 16,0 cm	70
114 91 0022	Pinzeta chirurgická rovná; 2×3 zuby; 18,0 cm	Tissue forceps; 2×3 teeth; 18,0 cm	70
114 91 0023	Pinzeta chirurgická rovná; 2×3 zuby; 20,0 cm	Tissue forceps; 2×3 teeth; 20,0 cm	70
114 91 0024	Pinzeta chirurgická rovná; 2×3 zuby; 25,0 cm	Tissue forceps; 2×3 teeth; 25,0 cm	70
114 91 0027	Pinzeta chirurgická rovná; 3×4 zuby; 14,5 cm	Tissue forceps; 3×4 teeth; 14,5 cm	70
114 91 0028	Pinzeta chirurgická rovná; 3×4 zuby; 16,0 cm	Tissue forceps; 3×4 teeth; 16,0 cm	70
114 91 0030	Pinzeta chirurgická rovná; 4×5 zubů; 14,5 cm	Tissue forceps; 4×5 teeth; 14,5 cm	70
114 91 0031	Pinzeta chirurgická rovná; 4×5 zubů; 16,0 cm	Tissue forceps; 4×5 teeth; 16,0 cm	70
114 91 0034	Pinzeta anatomická úzká; 13,0 cm	Dressing forceps; 13,0 cm	69
114 91 0036	Pinzeta anatomická úzká; 16,0 cm	Dressing forceps; 16,0 cm	69
114 91 0037	Pinzeta anatomická úzká; 18,0 cm	Dressing forceps; 18,0 cm	69
114 91 0105	Adson pinzeta anatomická; 12,0 cm	Adson dressing forceps; 12,0 cm	72
114 91 0106	Adson pinzeta anatomická; 15,0 cm	Adson dressing forceps; 15,0 cm	72
114 91 0108	Micro-Adson pinzeta anatomická; 12,0 cm	Micro-Adson dressing forceps; 12,0 cm	72
114 91 0111	Adson pinzeta chirurgická; 1×2 zuby; 12,0 cm	Adson tissue forceps; 1×2 teeth; 12,0 cm	72
114 91 0113	Adson pinzeta chirurgická; 1×2 zuby; 15,0 cm	Adson tissue forceps; 1×2 teeth; 15,0 cm	72
114 91 0114	Micro-Adson pinzeta chirurgická; 1×2 zuby; 12,0 cm	Micro-Adson tissue forceps; 1×2 teeth; 12,0 cm	72
114 91 0144	Lane pinzeta chirurgická; 1×2 zuby; 14,5 cm	Lane tissue forceps; 1×2 teeth; 14,5 cm	71
114 91 0146	Lane pinzeta chirurgická; 2×3 zuby; 14,5 cm	Lane tissue forceps; 2×3 teeth; 14,5 cm	71
114 91 0148	Gerald pinzeta anatomická rovná; 18,0 cm	Gerald dressing forceps; 18,0 cm	72
114 91 0149	Gerald pinzeta anatomická zahnutá; 18,0 cm	Gerald dressing forceps; 18,0 cm	72
114 91 0156	Potts-Smith pinzeta anatomická rovná; 18,0 cm	Potts-Smith dressing forceps; 18,0 cm	72
114 91 0162	Potts-Smith pinzeta chir. rovná; 1×2 zuby; 18,0 cm	Potts-Smith tissue forceps; 1×2 teeth; 18,0 cm	72
114 91 0180	Stille-Barraya pinzeta chirurgická; 3×4 zuby; 18,0 cm	Stille-Barraya tissue forceps; 3×4 teeth; 18,0 cm	73
114 91 0183	Ferris-Smith pinzeta chirurgická; 2×3 zuby; 18,0 cm	Ferris-Smith tissue forceps; 2×3 teeth; 18,0 cm	73
114 91 0211	Durante pinzeta chirurgická; 14,5 cm	Durante tissue forceps; 14,5 cm	73
114 91 0212	Durante pinzeta chirurgická; 16,0 cm	Durante tissue forceps; 16,0 cm	73
114 91 0215	Bonney pinzeta chirurgická; 1×2 zuby; 18,0 cm	Bonney tissue forceps; 1×2 teeth; 18,0 cm	73
114 91 0216	Bonney pinzeta chirurgická; 2×3 zuby; 18,0 cm	Bonney tissue forceps; 2×3 teeth; 18,0 cm	73
115	SVORKY	CLAMPS, FORCEPS	
115 08 0010	Mosquito-Halsted svorka na cévy rovná; 12,0 cm	Mosquito-Halsted artery forceps; 12,0 cm	80
115 08 0020	Mosquito-Halsted svorka na cévy zahnutá; 12,0 cm	Mosquito-Halsted artery forceps; 12,0 cm	80
115 08 0030	Mosquito-Halsted svorka rov. 1×2 zuby; 12,0 cm	Mosquito-Halsted artery forceps; 1×2 teeth; 12,0 cm	80
115 08 0040	Mosquito-Halsted svorka rov. hladká; 1×2 zuby; 12,0 cm	Mosquito-Halsted artery forceps; 1×2 teeth; 12,0 cm	80
115 08 0050	Mosquito-Halsted svorka Zahn. 1×2 zuby; 12,0 cm	Mosquito-Halsted artery forceps; 12,0 cm	80
115 08 0060	Mosquito-Halsted svorka Zahn. hladká; 1×2 zuby; 12,0 cm	Mosquito-Halsted artery forceps; 1×2 teeth; 12,0 cm	80
115 08 0071	Pean svorka na cévy rovná; 17,5 cm	Pean artery forceps; 17,5 cm	79
115 08 0121	Rochester-Pean svorka na cévy rovná; 20,0 cm	Rochester-Pean artery forceps; 20,0 cm	84
115 08 0171	Rochester-Pean svorka na cévy zahnutá; 20,0 cm	Rochester-Pean artery forceps; 20,0 cm	84

číslo – number	název	item	strana – page
115 08 0220	Rochester-Pean svorka na cévy rovná; 14,0 cm	Rochester-Pean artery forceps; 14,0 cm	84
115 08 0231	Rochester-Pean svorka na cévy rovná; 16,0 cm	Rochester-Pean artery forceps; 16,0 cm	84
115 08 0260	Rochester-Pean svorka na cévy zahnutá; 14,0 cm	Rochester-Pean artery forceps; 14,0 cm	84
115 08 0271	Rochester-Pean svorka na cévy zahnutá; 16,0 cm	Rochester-Pean artery forceps; 16,0 cm	84
115 08 0810	Backhaus svorka na prádlo; 8,0 cm	Backhaus towel forceps; 8,0 cm	79
115 08 0820	Backhaus svorka na prádlo; 13,0 cm	Backhaus towel forceps; 13,0 cm	79
115 08 1010	Mosquito-Halsted svorka na cévy rovná jemná; 12,0 cm	Mosquito-Halsted artery forceps; 12,0 cm	80
115 08 1020	Mosquito-Halsted svorka na cévy Zahn. Jemná; 12,0 cm	Mosquito-Halsted artery forceps; 12,0 cm	80
115 08 1030	Mosquito-Halsted svorka rovná jemná; 1×2 zuby; 12,0 cm	Mosquito-Halsted artery forceps; 1×2 teeth; 12,0 cm	80
115 08 1050	Mosquito-Halsted svorka Zahn. Jemná; 1×2 zuby; 12,0 cm	Mosquito-Halsted artery forceps; 1×2 teeth; 12,0 cm	80
115 08 1090	Kocher svorka na cévy jemná rovná; 14,2 cm	Kocher artery forceps fine straight; 14,2 cm	85
115 08 1100	Kocher svorka na cévy jemná zahnutá; 14,2 cm	Kocher artery forceps fine bent; 14,2 cm	85
115 08 1110	Kocher svorka na cévy jemná rovná; 15,2 cm	Kocher artery forceps fine straight; 15,2 cm	85
115 08 1120	Kocher svorka na cévy jemná zahnutá; 15,2 cm	Kocher artery forceps fine bent; 15,2 cm	85
115 08 1130	Peán svorka na cévy jemná rovná; 16 cm	Pean artery forceps fine straight; 16 cm	85
115 08 1140	Peán svorka na cévy jemná zahnutá; 16 cm	Pean artery forceps fine bent; 16 cm	85
115 08 1150	Peán svorka na cévy jemná rovná; 20 cm	Pean artery forceps fine straight; 20 cm	85
115 08 1160	Peán svorka na cévy jemná zahnutá; 20 cm	Pean artery forceps fine bent; 20 cm	85
115 08 1170	Peán svorka na cévy jemná rovná; 14,5 cm	Pean artery forceps fine straight; 14,5 cm	85
115 08 1180	Peán svorka na cévy jemná zahnutá; 14,6 cm	Pean artery forceps fine bent; 14,6 cm	85
115 14 1150	Overholt svorka na lobektomii fig.1; 19,5 cm	Overholt lobectomy forceps fig.1; 19,5 cm	86
115 91 0052	Pean svorka na cévy rovná; 14,0 cm	Pean artery forceps; 14,0 cm	79
115 91 0053	Pean svorka na cévy rovná; 16,0 cm	Pean artery forceps; 16,0 cm	79
115 91 0073	Micro-Mosquito svorka na cévy rovná; 12,0 cm	Micro-Mosquito artery forceps; 12,0 cm	81
115 91 0075	Micro-Mosquito svorka na cévy zahnutá; 12,0 cm	Micro-Mosquito artery forceps; 12,0 cm	81
115 91 0077	Micro-Mosquito svorka rovná 1×2 zuby; 12,0 cm	Micro-Mosquito artery forceps; 1×2 teeth ; 12,0 cm	81
115 91 0079	Micro-Mosquito svorka zahnutá 1×2 zuby; 12,0 cm	Micro-Mosquito artery forceps; 1×2 teeth; 12,0 cm	81
115 91 0080	Halsted-Mosquito svorka na cévy rovná; 12,5 cm	Halsted-Mosquito artery forceps; 12,5 cm	81
115 91 0082	Halsted-Mosquito svorka na cévy zahnutá; 12,5 cm	Halsted-Mosquito artery forceps; 12,5 cm	81
115 91 0084	Halsted-Mosquito svorka; 1×2 zuby rovná 12,5 cm	Halsted-Mosquito artery forceps; 1×2 teeth ;12,5 cm	81
115 91 0086	Halsted-Mosquito svorka zahnutá; 1×2 zuby; 12,5 cm	Halsted-Mosquito artery forceps; 1×2 teeth; 12,5 cm	81
115 91 0133	Ochsner-Kocher svorka na cévy rovná; 14,0 cm	Ochsner-Kocher artery forceps; 14,0 cm	79
115 91 0134	Ochsner-Kocher svorka na cévy rovná; 16,0 cm	Ochsner-Kocher artery forceps; 16,0 cm	79
115 91 0141	Ochsner-Kocher svorka na cévy zahnutá; 14,0 cm	Ochsner-Kocher artery forceps; 14,0 cm	79
115 91 0142	Ochsner-Kocher svorka na cévy zahnutá; 16,0 cm	Ochsner-Kocher artery forceps; 16,0 cm	79
115 91 0149	Pean svorka cévní; 13,0 cm	Pean artery forceps; 13,0 cm	239
115 91 0161	Overholt-Geissendoerfer svorka na cévy fig.1	Overholt-Geissendoerfer forceps fig.1	82
115 91 0162	Overholt-Geissendoerfer svorka na cévy fig.2	Overholt-Geissendoerfer forceps fig.2	82
115 91 0163	Overholt-Geissendoerfer svorka na cévy fig.3	Overholt-Geissendoerfer forceps fig.3	82
115 91 0180	Baby-Adson svorka na cévy zahnutá; 14,0 cm	Baby-Adson artery forceps; 14,0 cm	82
115 91 0181	Baby-Adson svorka na cévy zahnutá; 18,0 cm	Baby-Adson artery forceps; 18,0 cm	82
115 91 0186	Meeker svorka na cévy zahnutá; 18,0 cm	Meeker artery forceps; 18,0 cm	83
115 91 0193	Schmidt-Sawtell svorka na cévy silně zahnutá; 19,0 cm	Schmidt-Sawtell artery forceps; 19,0 cm	83
115 91 0216	Heiss svorka na cévy rovná fig.1; 20,0 cm	Heiss artery forceps fig.1; 20,0 cm	83
115 91 0217	Heiss svorka na cévy mírně zahnutá; 20,0 cm	Heiss artery forceps; 20,0 cm	83
115 91 0218	Heiss svorka na cévy silně zahnutá; 20,0 cm	Heiss artery forceps; 20,0 cm	83
115 91 0343	Backhaus svorka na prádlo; 11,0 cm	Backhaus towel forceps; 11,0 cm	79
115 91 0345	Backhaus svorka na prádlo; 11,0 cm	Backhaus towel forceps; 11,0 cm	79
115 91 0579	Mastin svorka na svaly; 17cm	Mastin muscular clamp; 17cm	86
116	KLEŠTĚ ŠTÍPACÍ	BONE RONGEURS, CUTTING FORCEPS	
116 08 0030	Luer kleště štípací na kosti rovné; 17,0 cm	Luer bone rongeurs; 17,0 cm	89
116 08 0040	Luer kleště štípací na kosti slabě zahnuté; 17,0 cm	Luer bone rongeurs; 17,0 cm	89
116 08 0070	Luer kleště štípací na kosti silně zahnuté; 15,0 cm	Luer bone rongeurs; 15,0 cm	89
116 08 0080	Luer kleště štípací na kosti zahnuté; 14,5 cm	Luer bone rongeurs; 14,5 cm	89
116 29 0010	Hartmann kleště na ušní polypy; 14,2 cm	Hartmann ear polypus forceps; 14,2 cm	92
116 29 0030	Hartmann kleště na ušní polypy; 14,2 cm	Hartmann ear polypus forceps; 14,2 cm	92
116 29 0120	Hartmann kleště na ušní polypy pod.; 2×10,5 mm; 10,0 cm	Hartmann ear polypus forceps; 2×10,5 mm; 10,0 cm	92
116 29 0170	Hartmann kleště na uš. polypy lžič.; 2,6 mm; 10,0 cm	Hartmann ear polypus forceps; 2,6 mm; 10,0 cm	92
116 29 0300	Strümpel kleště na ušní polypy; 2,2×7,0 mm	Strümpel ear polypus forceps; 2,2×7,0 mm	92
116 29 0400	Jansen kleště ušní štípací fig.1; 18,0 cm	Jansen mastoid forceps fig.1; 18,0 cm	93
116 29 0410	Jansen kleště ušní štípací fig.2; 18,0 cm	Jansen mastoid forceps fig.2; 18,0 cm	93
116 29 0740	Kleště štípací ostré horní; 1,7×2 mm; 7,0 cm	Mastoid forceps; 1,7×2 mm; 7,0 cm	93
116 29 0750	Kleště štípací ostré dolní; 1,7×2 mm; 7,0 cm	Mastoid forceps; 1,7×2 mm; 7,0 cm	93
116 29 0760	Kleště úchopné jemné; 0,6×0,9×3,5 mm; 7,0 cm	Grasping forceps; 0,6×0,9×3,5 mm; 7,0 cm	93
116 29 0770	Kleště úchopné jemné; 0,6×0,9×5,5 mm; 7,0 cm	Grasping forceps; 0,6×0,9×5,5 mm; 7,0 cm	93
116 91 0019	Luc kleště na nosní přepážku; 20,0 cm	Luc septum forceps; 20,0 cm	100
116 91 0020	Luc kleště na nosní přepážku; 20,0 cm	Luc septum forceps; 20,0 cm	100
116 91 0021	Luc kleště na nosní přepážku; 20,0 cm	Luc septum forceps; 20,0 cm	100
116 91 0023	Luc kleště na nosní přepážku; 20,0 cm	Luc septum forceps; 20,0 cm	100
116 91 0056	Hartmann štípací na mandly fig. 1; 13,0 cm	Hartmann tonsil punch fig.1; 13,0 cm	103

číslo – number	název	item	strana – page
116 91 0057	Hartmann štípáky na mandle fig. 2; 13,0 cm	Hartmann tonsil punch fig.2; 13,0 cm	103
116 91 0058	Hartmann štípáky na mandle fig. 3; 13,0 cm	Hartmann tonsil punch fig.3; 13,0 cm	103
116 91 0059	Schmeden štípáky na mandle; 13,0 cm	Schmeden tonsil punch; 13,0 cm	103
116 91 0060	Schmeden štípáky na mandle; 13,0 cm	Schmeden tonsil punch; 13,0 cm	103
116 91 0061	Schmeden štípáky na mandle; 13,0 cm	Schmeden tonsil punch; 13,0 cm	103
116 91 0062	Chevalier-Jackson kleště hrtanové fig.1; 30,0 cm	Chevalier-Jackson laryngeal forceps fig.1; 30,0 cm	104
116 91 0063	Chevalier-Jackson kleště hrtanové fig.1; 40,0 cm	Chevalier-Jackson laryngeal forceps fig.1; 40,0 cm	104
116 91 0064	Chevalier-Jackson kleště hrtanové fig.1; 50,0 cm	Chevalier-Jackson laryngeal forceps fig.1; 50,0 cm	104
116 91 0065	Chevalier-Jackson kleště hrtanové fig.1; 60,0 cm	Chevalier-Jackson laryngeal forceps fig.1; 60,0 cm	104
116 91 0066	Chevalier-Jackson kleště hrtanové fig.2; 30,0 cm	Chevalier-Jackson laryngeal forceps fig.2; 30,0 cm	104
116 91 0067	Chevalier-Jackson kleště hrtanové fig.2; 40,0 cm	Chevalier-Jackson laryngeal forceps fig.2; 40,0 cm	104
116 91 0068	Chevalier-Jackson kleště hrtanové fig.2; 50,0 cm	Chevalier-Jackson laryngeal forceps fig.2; 50,0 cm	104
116 91 0069	Chevalier-Jackson kleště hrtanové fig.2; 60,0 cm	Chevalier-Jackson laryngeal forceps fig.2; 60,0 cm	104
116 91 0070	Chevalier-Jackson kleště hrtanové fig.3; 30,0 cm	Chevalier-Jackson laryngeal forceps fig.3; 30,0 cm	104
116 91 0071	Chevalier-Jackson kleště hrtanové fig.3; 40,0 cm	Chevalier-Jackson laryngeal forceps fig.3; 40,0 cm	104
116 91 0072	Chevalier-Jackson kleště hrtanové fig.3; 50,0 cm	Chevalier-Jackson laryngeal forceps fig.3; 50,0 cm	104
116 91 0073	Chevalier-Jackson kleště hrtanové fig.3; 60,0 cm	Chevalier-Jackson laryngeal forceps fig.3; 60,0 cm	104
116 91 0074	Chevalier-Jackson kleště hrtanové fig.4; 30,0 cm	Chevalier-Jackson laryngeal forceps fig.4; 30,0 cm	104
116 91 0075	Chevalier-Jackson kleště hrtanové fig.4; 40,0 cm	Chevalier-Jackson laryngeal forceps fig.4; 40,0 cm	104
116 91 0076	Chevalier-Jackson kleště hrtanové fig.4; 50,0 cm	Chevalier-Jackson laryngeal forceps fig.4; 50,0 cm	104
116 91 0077	Chevalier-Jackson kleště hrtanové fig.4; 60,0 cm	Chevalier-Jackson laryngeal forceps fig.4; 60,0 cm	104
116 91 0078	Chevalier-Jackson kleště hrtanové fig.5; 30,0 cm	Chevalier-Jackson laryngeal forceps fig.5; 30,0 cm	104
116 91 0079	Chevalier-Jackson kleště hrtanové fig.5; 40,0 cm	Chevalier-Jackson laryngeal forceps fig.5; 40,0 cm	104
116 91 0080	Chevalier-Jackson kleště hrtanové fig.5; 50,0 cm	Chevalier-Jackson laryngeal forceps fig.5; 50,0 cm	104
116 91 0081	Chevalier-Jackson kleště hrtanové fig.5; 60,0 cm	Chevalier-Jackson laryngeal forceps fig.5; 60,0 cm	104
116 91 0082	Chevalier-Jackson kleště hrtanové fig.6; 30,0 cm	Chevalier-Jackson laryngeal forceps fig.6; 30,0 cm	104
116 91 0083	Chevalier-Jackson kleště hrtanové fig.6; 40,0 cm	Chevalier-Jackson laryngeal forceps fig.6; 40,0 cm	104
116 91 0084	Chevalier-Jackson kleště hrtanové fig.6; 50,0 cm	Chevalier-Jackson laryngeal forceps fig.6; 50,0 cm	104
116 91 0085	Chevalier-Jackson kleště hrtanové fig.6; 60,0 cm	Chevalier-Jackson laryngeal forceps fig.6; 60,0 cm	104
116 91 0086	Chevalier-Jackson kleště hrtanové fig.7; 30,0 cm	Chevalier-Jackson laryngeal forceps fig.7; 30,0 cm	104
116 91 0087	Chevalier-Jackson kleště hrtanové fig.7; 40,0 cm	Chevalier-Jackson laryngeal forceps fig.7; 40,0 cm	104
116 91 0088	Chevalier-Jackson kleště hrtanové fig.7; 50,0 cm	Chevalier-Jackson laryngeal forceps fig.7; 50,0 cm	104
116 91 0089	Chevalier-Jackson kleště hrtanové fig.7; 60,0 cm	Chevalier-Jackson laryngeal forceps fig.7; 60,0 cm	104
116 91 0090	Chevalier-Jackson kleště hrtanové fig.8; 30,0 cm	Chevalier-Jackson laryngeal forceps fig.8; 30,0 cm	104
116 91 0091	Chevalier-Jackson kleště hrtanové fig.8; 40,0 cm	Chevalier-Jackson laryngeal forceps fig.8; 40,0 cm	104
116 91 0092	Chevalier-Jackson kleště hrtanové fig.8; 50,0 cm	Chevalier-Jackson laryngeal forceps fig.8; 50,0 cm	104
116 91 0093	Chevalier-Jackson kleště hrtanové fig.8; 60,0 cm	Chevalier-Jackson laryngeal forceps fig.8; 60,0 cm	104
116 91 0094	Chevalier-Jackson kleště hrtanové fig.9; 30,0 cm	Chevalier-Jackson laryngeal forceps fig.9; 30,0 cm	104
116 91 0095	Chevalier-Jackson kleště hrtanové fig.9; 40,0 cm	Chevalier-Jackson laryngeal forceps fig.9; 40,0 cm	104
116 91 0096	Chevalier-Jackson kleště hrtanové fig.9; 50,0 cm	Chevalier-Jackson laryngeal forceps fig.9; 50,0 cm	104
116 91 0097	Chevalier-Jackson kleště hrtanové fig.9; 60,0 cm	Chevalier-Jackson laryngeal forceps fig.9; 60,0 cm	104
116 91 0098	Chevalier-Jackson kleště hrtanové fig.10; 30,0 cm	Chevalier-Jackson laryngeal forceps fig.10; 30,0 cm	104
116 91 0099	Chevalier-Jackson kleště hrtanové fig.10; 40,0 cm	Chevalier-Jackson laryngeal forceps fig.10; 40,0 cm	104
116 91 0100	Chevalier-Jackson kleště hrtanové fig.10; 50,0 cm	Chevalier-Jackson laryngeal forceps fig.10; 50,0 cm	104
116 91 0101	Chevalier-Jackson kleště hrtanové fig.10; 60,0 cm	Chevalier-Jackson laryngeal forceps fig.10; 60,0 cm	104
116 91 0102	Chevalier-Jackson kleště hrtanové fig.11; 30,0 cm	Chevalier-Jackson laryngeal forceps fig.11; 30,0 cm	104
116 91 0103	Chevalier-Jackson kleště hrtanové fig.11; 40,0 cm	Chevalier-Jackson laryngeal forceps fig.11; 40,0 cm	104
116 91 0104	Chevalier-Jackson kleště hrtanové fig.11; 50,0 cm	Chevalier-Jackson laryngeal forceps fig.11; 50,0 cm	104
116 91 0105	Chevalier-Jackson kleště hrtanové fig.11; 60,0 cm	Chevalier-Jackson laryngeal forceps fig.11; 60,0 cm	104
116 91 0106	Huber univerzální držadlo	Huber universal handle	105
116 91 0107	Bruenings koncovka rovná; 20,0 cm	Bruenings tip straight; 20,0 cm	105
116 91 0108	Bruenings koncovka rovná; 30,0 cm	Bruenings tip straight; 30,0 cm	105
116 91 0109	Bruenings koncovka rovná; 40,0 cm	Bruenings tip straight; 40,0 cm	105
116 91 0110	Bruenings koncovka rovná; 50,0 cm	Bruenings tip straight; 50,0 cm	105
116 91 0111	Bruenings koncovka rovná; 60,0 cm	Bruenings tip straight; 60,0 cm	105
116 91 0112	Bruenings koncovka zahnutá pevná; 20,0 cm	Bruenings tip curved rigid; 20,0 cm	105
116 91 0113	Bruenings koncovka zahnutá ohebná; 20,0 cm	Bruenings tip curved malleable; 20,0 cm	105
116 91 0114	Fraenkel koncovka	Fraenkel tip	106
116 91 0115	Seiffert koncovka	Seiffert tip	106
116 91 0116	Fraenkel koncovka misková	Fraenkel tip	106
116 91 0117	Scheinmann koncovka misková	Scheinmann tip	106
116 91 0118	Scheinmann grid koncovka	Scheinmann grid tip	106
116 91 0119	Bruenings koncovka; 2 mm	Bruenings tip; 2 mm	106
116 91 0120	Bruenings koncovka; 3 mm	Bruenings tip; 3 mm	106
116 91 0121	Bruenings koncovka; 4 mm	Bruenings tip; 4 mm	106
116 91 0122	Bruenings koncovka oválná	Bruenings tip	106
116 91 0123	Bruenings koncovka oválná	Bruenings tip	106
116 91 0124	Lange koncovka	Lange tip	106
116 91 0125	Krause koncovka; 2,5 mm	Krause tip; 2,5 mm	106
116 91 0126	Krause koncovka; 3,5 mm	Krause tip; 3,5 mm	106

číslo – number	název	item	strana – page
116 91 0127	Krause koncovka; plochá	Krause tip; plochá	106
116 91 0128	Cordes koncovka fig.1	Cordes tip fig.1	106
116 91 0129	Cordes koncovka fig.2	Cordes tip fig.2	106
116 91 0130	Cordes koncovka fig.3	Cordes tip fig.3	106
116 91 0131	Cordes koncovka fig.4	Cordes tip fig.4	106
116 91 0132	Schumacher koncovka	Schumacher tip	106
116 91 0133	Cordes koncovka fig.1	Cordes tip fig.1	106
116 91 0134	Cordes koncovka fig.2	Cordes tip fig.2	106
116 91 0135	Cordes koncovka	Cordes tip	106
116 91 0136	Rosenberg koncovka	Rosenberg tip	106
116 91 0137	Kleště mikro miskové rovné; 25,0 cm	Forceps micro straight; 25,0 cm	107
116 91 0138	Kleště mikro miskové zahnuté vpravo; 2 mm; 25,0 cm	Forceps micro curved right; 2 mm; 25,0 cm	107
116 91 0139	Kleště mikro miskové zahnuté vlevo; 2 mm; 25,0 cm	Forceps micro curved left; 2 mm; 25,0 cm	107
116 91 0143	Kleště na bronchoskopii; 30,0 cm	Bronchoscopy forceps; 30,0 cm	107
116 91 0144	Kleště na bronchoskopii; 35,0 cm	Bronchoscopy forceps; 35,0 cm	107
116 91 0145	Kleště na bronchoskopii; 40,0 cm	Bronchoscopy forceps; 40,0 cm	107
116 91 0146	Kleště na bronchoskopii; 45,0 cm	Bronchoscopy forceps; 45,0 cm	107
116 91 0147	Kleště na bronchoskopii; 50,0 cm	Bronchoscopy forceps; 50,0 cm	107
116 91 0148	Kleště na bronchoskopii; 55,0 cm	Bronchoscopy forceps; 55,0 cm	107
116 91 0149	Kleště na bronchoskopii; 60,0 cm	Bronchoscopy forceps; 60,0 cm	107
116 91 0150	Kleště na bronchoskopii; 30,0 cm	Bronchoscopy forceps; 30,0 cm	107
116 91 0151	Kleště na bronchoskopii; 35,0 cm	Bronchoscopy forceps; 35,0 cm	107
116 91 0152	Kleště na bronchoskopii; 40,0 cm	Bronchoscopy forceps; 40,0 cm	107
116 91 0153	Kleště na bronchoskopii; 45,0 cm	Bronchoscopy forceps; 45,0 cm	107
116 91 0154	Kleště na bronchoskopii; 50,0 cm	Bronchoscopy forceps; 50,0 cm	107
116 91 0155	Kleště na bronchoskopii; 55,0 cm	Bronchoscopy forceps; 55,0 cm	107
116 91 0156	Kleště na bronchoskopii; 60,0 cm	Bronchoscopy forceps; 60,0 cm	107
116 91 0157	Kleště na bronchoskopii; 30,0 cm	Bronchoscopy forceps; 30,0 cm	107
116 91 0158	Kleště na bronchoskopii; 35,0 cm	Bronchoscopy forceps; 35,0 cm	107
116 91 0159	Kleště na bronchoskopii; 40,0 cm	Bronchoscopy forceps; 40,0 cm	107
116 91 0160	Kleště na bronchoskopii; 45,0 cm	Bronchoscopy forceps; 45,0 cm	107
116 91 0161	Kleště na bronchoskopii; 50,0 cm	Bronchoscopy forceps; 50,0 cm	107
116 91 0162	Kleště na bronchoskopii; 55,0 cm	Bronchoscopy forceps; 55,0 cm	107
116 91 0163	Kleště na bronchoskopii; 60,0 cm	Bronchoscopy forceps; 60,0 cm	107
116 91 0164	Kleště na bronchoskopii; 30,0 cm	Bronchoscopy forceps; 30,0 cm	107
116 91 0165	Kleště na bronchoskopii; 35,0 cm	Bronchoscopy forceps; 35,0 cm	107
116 91 0166	Kleště na bronchoskopii; 40,0 cm	Bronchoscopy forceps; 40,0 cm	107
116 91 0167	Kleště na bronchoskopii; 45,0 cm	Bronchoscopy forceps; 45,0 cm	107
116 91 0168	Kleště na bronchoskopii; 50,0 cm	Bronchoscopy forceps; 50,0 cm	107
116 91 0169	Kleště na bronchoskopii; 55,0 cm	Bronchoscopy forceps; 55,0 cm	107
116 91 0170	Kleště na bronchoskopii; 60,0 cm	Bronchoscopy forceps; 60,0 cm	107
116 91 0171	Jurasz kleště na polypy fig.1; 23,0 cm	Jurasz polypus forceps fig.1; 23,0 cm	108
116 91 0172	Jurasz kleště na polypy fig.2; 23,0 cm	Jurasz polypus forceps fig.2; 23,0 cm	108
116 91 0173	Jurasz kleště na polypy fig.3; 23,0 cm	Jurasz polypus forceps fig.3; 23,0 cm	108
116 91 0174	Jurasz kleště na polypy fig.4; 23,0 cm	Jurasz polypus forceps fig.4; 23,0 cm	108
116 91 0175	Fraenkel kleště na polypy miskové; 26,5 cm	Fraenkel polypus forceps; 26,5 cm	108
116 91 0176	Lange kleště na polypy; 26,5 cm	Lange polypus forceps; 26,5 cm	108
116 91 0177	Kleště ušní mikro rovné; 8,0 cm	Micro ear forceps straight; 8,0 cm	94
116 91 0178	Kleště ušní mikro zahnuté vpravo; 8,0 cm	Micro ear forceps curved right; 8,0 cm	94
116 91 0179	Kleště ušní mikro zahnuté nahoru; 8,0 cm	Micro ear forceps curved up; 8,0 cm	94
116 91 0180	Kleště ušní mikro zahnuté vlevo; 8,0 cm	Micro ear forceps curved left; 8,0 cm	94
116 91 0181	Kleště ušní mikro zahnuté dolů; 8,0 cm	Micro ear forceps curved down; 8,0 cm	94
116 91 0182	Crura-Nipper kleště ušní štípací; 8,0 cm	Crura-Nipper micro ear forceps; 8,0 cm	94
116 91 0183	McGee kleště ušní štípací; 8,0 cm	McGee micro ear forceps; 8,0 cm	94
116 91 0184	Dieter kleště štípací mikro; 8,0 cm	Dieter micro ear forceps; 8,0 cm	95
116 91 0185	Dieter kleště štípací mikro; 8,0 cm	Dieter micro ear forceps; 8,0 cm	95
116 91 0186	Wullstein kleště ušní štípací mikro; 8,0 cm	Wullstein micro ear forceps; 8,0 cm	95
116 91 0187	Wullstein kleště ušní štípací mikro; 19,0 cm	Wullstein micro ear forceps; 19,0 cm	95
116 91 0188	Citelli štípací; 1 mm; 6,0 cm	Citelli punch; 1 mm; 6,0 cm	96
116 91 0189	Citelli štípací; 2 mm; 6,0 cm	Citelli punch; 2 mm; 6,0 cm	96
116 91 0190	Citelli štípací; 3 mm; 6,0 cm	Citelli punch; 3 mm; 6,0 cm	96
116 91 0191	Beyer štípací; 9 cm	Beyer punch; 9 cm	96
116 91 0192	Weil-Blakesley kleště štípací nosní; 12,5 cm	Weil-Blakesley nasal cutting forceps; 12,5 cm	97
116 91 0193	Weil-Blakesley kleště štípací nosní; 12,5 cm	Weil-Blakesley nasal cutting forceps; 12,5 cm	97
116 91 0194	Weil-Blakesley kleště štípací nosní; 12,5 cm	Weil-Blakesley nasal cutting forceps; 12,5 cm	97
116 91 0195	Weil-Blakesley kleště štípací nosní; 12,5 cm	Weil-Blakesley nasal cutting forceps; 12,5 cm	97
116 91 0196	Weil-Blakesley kleště štípací nosní; 12,5 cm	Weil-Blakesley nasal cutting forceps; 12,5 cm	97
116 91 0197	Weil-Blakesley kleště štípací nosní; 12,5 cm	Weil-Blakesley nasal cutting forceps; 12,5 cm	97
116 91 0198	Weil-Blakesley kleště štípací nosní; 12,5 cm	Weil-Blakesley nasal cutting forceps; 12,5 cm	97
116 91 0199	Weil-Blakesley kleště štípací nosní; 12,5 cm	Weil-Blakesley nasal cutting forceps; 12,5 cm	97

číslo – number	název	item	strana – page
116 91 0200	Weil-Blakesley kleště štípací nosní; 12,5 cm	Weil-Blakesley nasal cutting forceps; 12,5 cm	97
116 91 0201	Weil-Blakesley kleště štípací nosní; 12,5 cm	Weil-Blakesley nasal cutting forceps; 12,5 cm	97
116 91 0202	Hartmann kleště štípací nosní; 12,5 cm	Hartmann nasal cutting forceps; 12,5 cm	98
116 91 0203	Hartmann kleště štípací nosní; 12,5 cm	Hartmann nasal cutting forceps; 12,5 cm	98
116 91 0204	Hartmann kleště štípací nosní; 12,5 cm	Hartmann nasal cutting forceps; 12,5 cm	98
116 91 0205	Hartmann kleště štípací nosní; 12,5 cm	Hartmann nasal cutting forceps; 12,5 cm	98
116 91 0206	Gruenwald kleště štípací nosní; 12,5 cm	Gruenwald nasal cutting forceps; 12,5 cm	98
116 91 0207	Gruenwald kleště štípací nosní; 12,5 cm	Gruenwald nasal cutting forceps; 12,5 cm	98
116 91 0208	Gruenwald kleště štípací nosní; 12,5 cm	Gruenwald nasal cutting forceps; 12,5 cm	98
116 91 0209	Gruenwald kleště štípací nosní; 12,5 cm	Gruenwald nasal cutting forceps; 12,5 cm	98
116 91 0210	Schmeden kleště štípací nosní; 12,5 cm	Schmeden nasal cutting forceps; 12,5 cm	98
116 91 0211	Struycken kleště štípací nosní; 12,5 cm	Struycken nasal cutting forceps; 12,5 cm	98
116 91 0212	Myles kleště štípací nosní; 12,5 cm	Myles nasal cutting forceps; 12,5 cm	98
116 91 0213	Myles kleště štípací nosní; 12,5 cm	Myles nasal cutting forceps; 12,5 cm	98
116 91 0214	Myles kleště štípací nosní; 12,5 cm	Myles nasal cutting forceps; 12,5 cm	98
116 91 0215	Myles kleště štípací nosní; 12,5 cm	Myles nasal cutting forceps; 12,5 cm	98
116 91 0216	Myles kleště štípací nosní; 12,5 cm	Myles nasal cutting forceps; 12,5 cm	98
116 91 0217	Myles kleště štípací nosní; 12,5 cm	Myles nasal cutting forceps; 12,5 cm	98
116 91 0218	Myles kleště štípací nosní; 12,5 cm	Myles nasal cutting forceps; 12,5 cm	98
116 91 0219	Takahashi kleště štípací nosní rovné; 12,5 cm	Takahashi nasal cutting forceps straight; 12,5 cm	99
116 91 0220	Takahashi kleště štípací nosní zahnuté; 12,5 cm	Takahashi nasal cutting forceps curved; 12,5 cm	99
116 91 0221	Takahashi kleště štípací nosní rovné; 12,5 cm	Takahashi nasal cutting forceps straight; 12,5 cm	99
116 91 0222	Takahashi kleště štípací nosní rovné; 12,5 cm	Takahashi nasal cutting forceps straight; 12,5 cm	99
116 91 0223	Jansen-Middleton kleště štípací nosní; 4×20 mm; 19,0 cm	Jansen-Middleton nasal cutting forceps; 4×20 mm; 19,0 cm	99
116 91 0224	Jansen-Middleton kleště štípací nosní; 5×15 mm; 19,0 cm	Jansen-Middleton nasal cutting forceps; 5×15 mm; 19,0 cm	99
116 91 0225	Craig kleště na nosní přepážku; 5×18 mm; 17,0 cm	Craig septum forceps; 5×18 mm; 17,0 cm	100
116 91 0226	Craig-Domnick kleště na nosní přepážku; 7×18 mm; 17,0 cm	Craig-Domnick septum forceps; 7×18 mm; 17,0 cm	100
116 91 0227	Craig-Domnick kleště na nosní přepážku; 7×18 mm; 17,0 cm	Craig-Domnick septum forceps; 7×18 mm; 17,0 cm	100
116 91 0228	Bruenings kleště na nosní přepážku; 19,0 cm	Bruenings septum forceps; 19,0 cm	100
116 91 0229	Bruenings kleště na nosní přepážku; 19,0 cm	Bruenings septum forceps; 19,0 cm	100
116 91 0230	Bruenings kleště na nosní přepážku; 19,0 cm	Bruenings septum forceps; 19,0 cm	100
116 91 0231	Bruenings kleště na nosní přepážku; 19,0 cm	Bruenings septum forceps; 19,0 cm	100
116 91 0232	Knight kleště na nosní přepážku; 18,0 cm	Knight septum forceps; 18,0 cm	100
116 91 0233	Heymann kleště na nosní přepážku; 18,0 cm	Heymann septum forceps; 18,0 cm	100
116 91 0234	Heymann kleště na nosní přepážku; 18,0 cm	Heymann septum forceps; 18,0 cm	100
116 91 0235	Heymann kleště na nosní přepážku; 18,0 cm	Heymann septum forceps; 18,0 cm	100
116 91 0236	Hajek-Kofler štípací sfenoid. horní; 4×4 mm; 14,0 cm	Hajek-Kofler sphenoid punch curved up; 4×4 mm; 14,0 cm	101
116 91 0237	Hajek-Kofler štípací sfenoid. dolní; 4×4 mm; 14,0 cm	Hajek-Kofler sphenoid punch curved down; 4×4 mm; 14,0 cm	101
116 91 0238	Hajek-Kofler štípací sfenoid. horní; 3,5 × 3,5 mm; 14,0 cm	Hajek-Kofler sphenoid punch curved up; 3,5 × 3,5 mm; 14,0 cm	101
116 91 0239	Hajek-Kofler štípací sfenoid. dolní; 3,5 × 3,5 mm; 14,0 cm	Hajek-Kofler sphenoid punch curved down; 3,5 × 3,5 mm; 14,0 cm	101
116 91 0240	Kerrison štípací; 14,0 cm	Kerrison sphenoid punch; 14,0 cm	101
116 91 0241	Hajek-Claus štípací sfenoidální; 20,0 cm	Hajek-Claus sphenoid punch; 20,0 cm	102
116 91 0242	Hartmann kleště ušní štípací; 2,0 mm; 8,5 cm	Hartmann ear forceps; 2,0 mm; 8,5 cm	91
116 91 0243	Hartmann kleště ušní štípací; 2,5 mm; 8,5 cm	Hartmann ear forceps; 2,5 mm; 8,5 cm	91
116 91 0244	Hartmann kleště ušní štípací; 3,0 mm; 8,5 cm	Hartmann ear forceps; 3,0 mm; 8,5 cm	91
116 91 0245	Hartmann kleště ušní štípací; 2,0 mm; 8,5 cm	Hartmann ear forceps; 2,0 mm; 8,5 cm	91
116 91 0246	Hartmann kleště ušní štípací; 2,5 mm; 8,5 cm	Hartmann ear forceps; 2,5 mm; 8,5 cm	91
116 91 0247	Hartmann kleště ušní štípací; 3,0 mm; 8,5 cm	Hartmann ear forceps; 3,0 mm; 8,5 cm	91
116 91 0248	Strümpel kleště ušní štípací; 8,5 cm	Strümpel ear forceps; 8,5 cm	91
116 91 0249	Hartmann kleště ušní štípací; 8,5 cm	Hartmann ear forceps; 8,5 cm	91
116 91 0250	Hartmann kleště ušní štípací; 8,5 cm	Hartmann ear forceps; 8,5 cm	91
116 91 0251	Hartmann kleště ušní štípací; 8,5 cm	Hartmann ear forceps; 8,5 cm	91
116 91 0252	Kerrison štípací; 9,0 cm	Kerrison punch; 9,0 cm	102
116 91 0253	Kerrison štípací; 9,0 cm	Kerrison punch; 9,0 cm	102
116 91 0254	Kerrison štípací; 9,0 cm	Kerrison punch; 9,0 cm	102
116 91 0255	Kerrison štípací; 9,0 cm	Kerrison punch; 9,0 cm	102
116 91 0260	Böhler kleště štípací na kosti; 15,0 cm	Böhler bone ronguers; 15,0 cm	90
116 91 0261	Böhler kleště štípací na kosti; 15,0 cm	Böhler bone ronguers; 15,0 cm	90
116 91 0262	Böhler kleště štípací na kosti; 15,0 cm	Böhler bone ronguers; 15,0 cm	90
116 91 0263	Kleinert-Kutz kleště štípací na kosti; 15,0 cm	Kleinert-Kutz bone ronguers; 15,0 cm	90
116 91 0264	Kleinert-Kutz kleště štípací na kosti; 15,0 cm	Kleinert-Kutz bone ronguers; 15,0 cm	90
116 91 0515	Stellbrink kleště štípací na kosti; 17,0 cm	Stellbrink bone ronguers; 17,0 cm	90
116 91 0516	Stellbrink kleště štípací na kosti; 17,0 cm	Stellbrink bone ronguers; 17,0 cm	90
116 91 0522	Blumenthal kleště štípací na kosti; 15,5 cm	Blumenthal bone ronguers; 15,5 cm	90
116 91 0523	Blumenthal kleště štípací na kosti; 15,5 cm	Blumenthal bone ronguers; 15,5 cm	90
116 91 0524	Blumenthal kleště štípací na kosti; 15,5 cm	Blumenthal bone ronguers; 15,5 cm	90
116 91 0527	Luer kleště štípací na kosti; 15,0 cm	Luer bone ronguers; 15,0 cm	89
116 91 0528	Luer kleště štípací na kosti; 15,0 cm	Luer bone ronguers; 15,0 cm	89
116 91 0529	Luer kleště štípací na kosti; 15,0 cm	Luer bone ronguers; 15,0 cm	89

číslo – number	název	item	strana – page
117	KLEŠTĚ ÚCHOPNÉ	GRASPING FORCEPS	
117 27 0260	Gross-Maier kleště tamponové rovné s uzávěř; 26,0 cm	Gross-Maier sponge holding forceps; 26,0 cm	111
117 27 0270	Kleště tamponové rovné bez uzávěři; 25,7 cm	Sponge holding forceps; 25,7 cm	111
117 27 0280	Gross-Maier kleště tamponové Zahn. S uzávěř; 25,7 cm	Gross-Maier sponge holding forceps; 25,7 cm	111
117 27 0290	Kleště tamponové zahnuté bez uzávěři; 25,7 cm	Sponge holding forceps; 25,7 cm	111
117 29 0060	Kleště ušní úchopné jemné; 0,6×0,9×3,5 mm; 6,8 cm	Ear forceps; 0,6×0,9×3,5 mm; 6,8 cm	113
117 29 0070	Kleště ušní úchopné jemné; 0,6×0,9×5,5 mm; 7,0 cm	Ear forceps; 0,6×0,9×5,5 mm; 7,0 cm	113
117 29 0090	Kleště ušní úchopné jemné; 1,5×4,5 mm; 7,8 cm	Ear forceps; 1,5×4,5 mm; 7,8 cm	113
117 29 0100	Kleště ušní úchopné jemné; 2,0×7,0 mm; 8,3 cm	Ear forceps; 2,0×7,0 mm; 8,3 cm	113
117 29 0130	Kleště ušní Zahn.levé jemné; 0,6×0,9×3,5 mm; 6,8 cm	Ear forceps; 0,6×0,9×3,5 mm; 6,8 cm	113
117 29 0140	Kleště ušní Zahn.pravé jemné; 0,6×0,9×3,5mm; 6,8 cm	Ear forceps; 0,6×0,9×3,5mm; 6,8 cm	113
117 29 0400	Kleště ušní úchopné; 0,8×2,0×5,0 mm; 9,8 cm	Ear forceps; 0,8×2,0×5,0 mm; 9,8 cm	113
117 29 0410	Kleště ušní úchopné; 0,2×2,0×5,0 mm; 9,8 cm	Ear forceps; 0,2×2,0×5,0 mm; 9,8 cm	113
117 29 0420	Kleště ušní zahnuté vlevo; 0,8×2,0×5,0 mm; 9,8 cm	Ear forceps; 0,8×2,0×5,0 mm; 9,8 cm	113
117 29 0430	Kleště ušní zahnuté vpravo; 0,8×2,0×5,0 mm; 9,8 mm	Ear forceps; 0,8×2,0×5,0 mm; 9,8 mm	113
117 29 0440	Kleště ušní úchopné; 0,5×2,0×5,0 mm; 9,8 cm	Ear forceps; 0,5×2,0×5,0 mm; 9,8 cm	113
117 29 0450	Kleště ušní úchopné; 0,8×8,5×8,5 mm; 10,2 cm	Ear forceps; 0,8×8,5×8,5 mm; 10,2 cm	113
117 29 0460	Kleště ušní úchopné; 30°; 0,8×2,0×5,0 mm; 9,8 cm	Ear forceps; 30°; 0,8×2,0×5,0 mm	113
117 29 0470	Kleště ušní úchopné; 1,2×2,0×5,0 mm; 9,8 cm	Ear forceps; 1,2×2,0×5,0 mm; 9,8 cm	113
117 29 0480	Kleště ušní úchopné se zoubky; 1,5×2,0×8,0 mm; 9,8 cm	Ear forceps; 1,5×2,0×8,0 mm; 9,8 cm	113
117 30 0100	Hartmann kleště na nosní polypy; 3,0 mm; 20,4 cm	Hartmann nasal polypus forceps; 3,0 mm; 20,4 cm	116
117 30 0110	Hartmann kleště na nosní polypy; 4,0 mm; 20,4 cm	Hartmann nasal polypus forceps; 4,0 mm; 20,4 cm	116
117 30 0400	Kleště na nosní skořepu; 4,0 mm; 18,3 cm	Nasal septum forceps; 4,0 mm; 18,3 cm	119
117 30 0410	Kleště na nosní skořepu; 7,0 mm; 18,3 cm	Nasal septum forceps; 7,0 mm; 18,3 cm	119
117 31 0010	Collin kleště na jazyk okénkové; 16,7 cm	Collin tongue holding forceps; 16,7 cm	120
117 31 0030	Löbker kleště na jazyk jednoháčkové; 15,0 cm	Löbker tongue holding forceps; 15,0 cm	120
117 91 0177	Young kleště na jazyk; 17,0 cm	Young tongue forceps; 17,0 cm	120
117 91 0178	Koncovky gumové pro kleště Young - pár	Rubber end-pieces only for forceps Young	120
117 91 0179	Lahey kleště úchopné; 15,0 cm	Lahey ear forceps; 15,0 cm	112
117 91 0180	Lahey kleště úchopné; 20,0 cm	Lahey ear forceps; 20,0 cm	112
117 91 0181	Fraenkel kleště na polypy; 18,0 cm	Fraenkel polypus forceps; 18,0 cm	116
117 91 0182	Buck kleště na cizí tělesa	Buck ear forceps	112
117 91 0183	Quire kleště na cizí tělesa	Quire ear forceps	112
117 91 0184	Hartmann-Wullstein kleště na polypy; 8,5 cm	Hartmann-Wullstein polypus forceps; 8,5 cm	116
117 91 0185	Hartmann-Wullstein kleště miskové; 8,5 cm	Hartmann-Wullstein polypus forceps; 8,5 cm	116
117 91 0186	Hartmann kleště na polypy; 8,5 cm	Hartmann polypus forceps; 8,5 cm	116
117 91 0187	Hartmann kleště na polypy; 14,0 cm	Hartmann polypus forceps; 14,0 cm	116
117 91 0188	Hartmann kleště na polypy; 1×2 zuby; 8,5 cm	Hartmann polypus forceps; 1×2 teeth; 8,5 cm	116
117 91 0189	Hartmann kleště na polypy; 1×2 zuby; 14,0 cm	Hartmann polypus forceps; 1×2 teeth; 14,0 cm	116
117 91 0190	Hartmann-Noyes kleště ušní; 8,5 cm	Hartmann-Noyes ear forceps; 8,5 cm	115
117 91 0191	Duckbill kleště ušní; 8,5 cm	Duckbill ear forceps; 8,5 cm	115
117 91 0192	Weingärtner kleště ušní; 8,5 cm	Weingärtner ear forceps; 8,5 cm	115
117 91 0193	White kleště na mandle; 18,0 cm	White tonsil forceps; 18,0 cm	121
117 91 0194	White kleště na mandle; 23,0 cm	White tonsil forceps; 23,0 cm	121
117 91 0195	Colver kleště na mandle rovné; 19,0 cm	Colver tonsil forceps straight; 19,0 cm	121
117 91 0196	Colver kleště na mandle zahnuté; 19,0 cm	Colver tonsil forceps curved; 19,0 cm	121
117 91 0197	Museux kleště úchopné; 20,0 cm	Museux grasping forceps; 20,0 cm	121
117 91 0198	Kleště mikro laryngeální rovné; 2,0 mm; 25,0 cm	Laryngeal micro forceps straight; 2,0 mm; 25,0 cm	120
117 91 0199	Kleště mikro laryngeální zahnuté; 2,0 mm; 25,0 cm	Laryngeal micro forceps curved; 2,0 mm; 25,0 cm	120
117 91 0200	Kleště mikro laryngeální zahnuté; 2,0 mm; 25,0 cm	Laryngeal micro forceps curved; 2,0 mm; 25,0 cm	120
117 91 0215	Hartmann kleště nosní na polypy; 16,0 cm	Hartmann nasal polypus forceps; 16,0 cm	117
117 91 0216	Hartmann kleště nosní na polypy; 20,0 cm	Hartmann nasal polypus forceps; 20,0 cm	117
117 91 0217	Heymann-Knight kleště nosní na polypy; 18,0cm	Heymann-Knight nasal polypus forceps; 18,0cm	117
117 91 0218	Lubet-Barbon kleště nosní na polypy; 20,0 cm	Lubet-Barbon nasal polypus forceps; 20,0 cm	117
117 91 0219	Kilian kleště nosní na polypy; 17,0 cm	Kilian nasal polypus forceps; 17,0 cm	117
117 91 0220	Westmacott kleště nosní na polypy fig.1; 20,0 cm	Westmacott nasal polypus forceps fig.1; 20,0 cm	117
117 91 0221	Westmacott kleště nosní na polypy fig.2; 20,0 cm	Westmacott nasal polypus forceps fig.2; 20,0 cm	117
117 91 0222	Asch kleště na rovnání přepážky zahnuté; 23,0cm	Asch septum straightening forceps; 23,0cm	118
117 91 0223	Walsham kleště na rovnání přepážky fig.00; 23,0 cm	Walsham septum straightening forceps fig.00; 23,0 cm	118
117 91 0224	Walsham kleště na rovnání přepážky fig.1; 23,0 cm	Walsham septum straightening forceps fig.1; 23,0 cm	118
117 91 0225	Walsham kleště na rovnání přepážky fig.2; 23,0 cm	Walsham septum straightening forceps fig.2; 23,0 cm	118
117 91 0226	Cottle-Walsham kleště na rovnání přepážky; 22,0 cm	Cottle-Walsham septum straightening forceps; 22,0 cm	118
117 91 0227	Rubin kleště na rovnání přepážky; 20,0 cm	Rubin septum straightening forceps; 20,0 cm	118
117 91 0228	Kressner kleště na přepážku; 2,5×60 mm; 20,0 cm	Kressner septum forceps; 2,5×60 mm; 20,0 cm	119
117 91 0229	Kressner kleště na přepážku; 4×70 mm; 20,0 cm	Kressner septum forceps; 4×70 mm; 20,0 cm	119
117 91 0230	Kressner kleště na přepážku; 5×75 mm; 20,0 cm	Kressner septum forceps; 5×75 mm; 20,0 cm	119
117 91 0231	Kleště ušní úchopné rovné; 4,5×0,8 mm; 8,0 cm	Ear forceps straight; 4,5×0,8 mm; 8,0 cm	114
117 91 0232	Kleště ušní úchopné rovné hladké; 4,5×0,8 mm; 8,0 cm	Ear forceps straight smooth; 4,5×0,8 mm; 8,0 cm	114
117 91 0233	Kleště ušní úchopné zahnuté vlevo; 4,5×0,8 mm; 8,0 cm	Ear forceps curved left; 4,5×0,8 mm; 8,0 cm	114
117 91 0234	Kleště ušní úchopné zahnuté vpravo; 4,5×0,8 mm; 8,0 cm	Ear forceps curved right; 4,5×0,8 mm; 8,0 cm	114

číslo – number	název	item	strana – page
117 91 0235	Kleště ušní úchopné zahnuté nahoru; 4,5×0,8 mm; 8,0 cm	Ear forceps curved up; 4,5×0,8 mm; 8,0 cm	114
117 91 0236	Kleště ušní úchopné zahnuté dolů; 4,5×0,8 mm; 8,0 cm	Ear forceps curved down; 4,5×0,8 mm; 8,0 cm	114
117 91 0237	Kleště ušní úchopné; 8,5×0,8 mm; 8,0 cm	Ear forceps; 8,5×0,8 mm; 8,0 cm	114
117 91 0238	Kleště ušní úchopné; 8,5×1,8 mm; 8,0 cm	Ear forceps; 8,5×1,8 mm; 8,0 cm	114
117 91 0239	Kleště ušní úchopné; 4,0×0,6 mm; 8,0 cm	Ear forceps; 4,0×0,6 mm; 8,0 cm	114
117 91 0240	Kleště ušní úchopné hladké čelisti; 4,0×0,6 mm; 8,0 cm	Ear forceps smooth; 4,0×0,6 mm; 8,0 cm	114
117 91 0241	Wullstein kleště úchopné ušní; 8,5 cm	Wullstein ear forceps; 8,5 cm	115
117 91 0242	Wullstein kleště úchopné ušní; 8,5 cm	Wullstein ear forceps; 8,5 cm	115
118	HÁKY	HOOKS, RETRACTORS	
118 08 0010	Háček na rány jednozubý ostrý; 16,5 cm	Delicate hook 1 prong sharp; 16,5 cm	125
118 08 0020	Háček na rány dvouzubý ostrý; 16,5 cm	Delicate hook 2 prongs sharp; 16,5 cm	125
118 08 0050	Háček na rány jednozubý tupý; 16,5 cm	Delicate hook 1 prong blunt; 16,5 cm	125
118 08 0060	Háček na rány dvouzubý tupý; 16,5 cm	Delicate hook 2 prongs blunt; 16,5 cm	125
118 08 0650	Middeldorpf hák na rány okénk.; 14×12 mm; 22,0 cm	Middeldorpf retractor; 14×12 mm; 22,0 cm	132
118 08 0660	Middeldorpf hák na rány okénk.; 21×21 mm; 22,0 cm	Middeldorpf retractor; 21×21 mm; 22,0 cm	132
118 08 0670	Middeldorpf hák na rány okénk.; 32×31 mm; 23,5 cm	Middeldorpf retractor; 32×31 mm; 23,5 cm	132
118 08 0680	Middeldorpf hák na rány okénk.; 62×50 mm; 28,0 cm	Middeldorpf retractor; 62×50 mm; 28,0 cm	132
118 08 0760	Caldwell-Luc hák na rány; 12×13 mm; 23,0 cm	Caldwell-Luc retractor; 12×13 mm; 23,0 cm	132
118 08 0770	Caldwell-Luc hák na rány; 37×13 mm; 23,0 cm	Caldwell-Luc retractor; 37×13 mm; 23,0 cm	132
118 08 0780	Caldwell-Luc hák na rány; 35×13 mm; 23,0 cm	Caldwell-Luc retractor; 35×13 mm; 23,0 cm	132
118 12 0010	Háček pro plastiku jednozubý ostrý fig.1; 16,0 cm	Plastic hook 1 prong sharp fig.1; 16,0 cm	125
118 12 0020	Háček pro plastiku jednozubý ostrý fig.2; 16,0 cm	Plastic hook 1 prong sharp fig.2; 16,0 cm	125
118 12 0050	Háček pro plastiku dvouzubý tupý; 5,0 mm; 16,0 cm	Plastic hook 2 prongs blunt; 5,0 mm; 16,0 cm	129
118 12 0060	Háček pro plastiku dvouzubý ostrý; 5,0 mm; 16,0 cm	Plastic hook 2 prongs sharp; 5,0 mm; 16,0 cm	129
118 12 0070	Háček pro plastiku čtyřzubý tupý; 12,0 mm; 16,0 cm	Plastic hook 4 prongs blunt; 12,0 mm; 16,0 cm	129
118 12 0080	Háček pro plastiku čtyřzubý ostrý; 12,0 mm; 16,0 cm	Plastic hook 4 prongs sharp; 12,0 mm; 16,0 cm	129
118 12 0090	Háček na křídlo nosní oboustranný; 10,5 cm	Nasal alar hook; 10,5 cm	128
118 29 0010	Hartmann háček ušní jednozubý ostrý; 17,0 cm	Hartmann ear hook 1 prong sharp; 17,0 cm	127
118 29 0040	Berthold háček ušní jednozubý ostrý bajonet.; 18,0 cm	Berthold ear hook 1 prong sharp; 18,0 cm	127
118 29 0060	Schwartzke háček ušní tupý pravouhle zahnutý; 17,0 cm	Schwartzke ear hook blunt; 17,0 cm	127
118 29 0070	Troeltsch hák na zvukovod; 20,5 cm	Troeltsch sound hook; 20,5 cm	127
118 29 0140	Ludewig háček na kovadlinku levý; 17,0 cm	Ludewig incus hook; 17,0 cm	127
118 29 0150	Ludewig háček na kovadlinku pravý; 17,0 cm	Ludewig incus hook; 17,0 cm	127
118 30 0120	Hák na choanální polypy; 22,5 cm	Choanal hook; 22,5 cm	130
118 31 0040	Hák resekční čtyřzubý rovný; 16,4 cm	Resection hook 4 prongs straight; 16,4 cm	131
118 31 0050	Hák resekční čtyřzubý pravý; 16,2 cm	Resection hook 4 prongs right; 16,2 cm	131
118 31 0060	Hák resekční čtyřzubý levý; 16,2 cm	Resection hook 4 prongs left; 16,2 cm	131
118 31 0070	Hák resekční dvouzubý rovný; 16,4 cm	Resection hook 2 prongs straight; 16,4 cm	131
118 31 0080	Hák resekční dvouzubý pravý; 16,1 cm	Resection hook 2 prongs right; 16,1 cm	131
118 31 0090	Hák resekční dvouzubý levý; 16,1 cm	Resection hook 2 prongs left; 16,1 cm	131
118 34 0020	Hák tracheální plochý; 19×11 mm; 23,5 cm	Tracheal hook; 19×11 mm; 23,5 cm	133
118 34 0030	Hák tracheální dvakrát lomený; 16,5×5,0 mm; 21,0 cm	Tracheal hook; 16,5×5,0 mm; 21,0 cm	133
118 38 0010	Desmarres držátko víček; 10,0 mm; 13,0 cm	Desmarres delicatehook; 10,0 mm; 13,0 cm	126
118 38 0020	Desmarres držátko víček; 12,0 mm; 13,0 cm	Desmarres delicatehook; 12,0 mm; 13,0 cm	126
118 38 0030	Desmarres držátko víček; 14,0 mm; 13,0 cm	Desmarres delicatehook; 14,0 mm; 13,0 cm	126
118 91 0027	Hák jemný třízubý ostrý; 16,0 cm	Retractor sharp 3 prongs; 16,0 cm	125
118 91 0028	Hák jemný čtyřzubý ostrý; 16,0 cm	Retractor sharp 4 prongs; 16,0 cm	125
118 91 0035	Hák jemný třízubý tupý; 16,0 cm	Retractor blunt 3 prongs; 16,0 cm	125
118 91 0036	Hák jemný čtyřzubý tupý; 16,0 cm	Retractor blunt 4 prongs; 16,0 cm	125
118 91 0045	Hák jemný dvouzubý ohebný ostrý; 16,0 cm	Retractor sharp flex. 2 prongs; 16,0 cm	126
118 91 0046	Hák jemný třízubý ohebný ostrý; 16,0 cm	Retractor sharp flex. 3 prongs; 16,0 cm	126
118 91 0047	Hák jemný čtyřzubý ohebný ostrý; 16,0 cm	Retractor sharp flex. 4 prongs; 16,0 cm	126
118 91 0048	Hák jemný dvouzubý ohebný tupý; 16,0 cm	Retractor blunt flex. 2 prongs; 16,0 cm	126
118 91 0049	Hák jemný třízubý ohebný tupý; 16,0 cm	Retractor blunt flex. 3 prongs; 16,0 cm	126
118 91 0050	Hák jemný čtyřzubý ohebný tupý; 16,0 cm	Retractor blunt flex. 4 prongs; 16,0 cm	126
118 91 0051	Joseph hák jemný; 16,0 cm	Joseph Delicate hook; 16,0 cm	125
118 91 0052	Joseph hák jemný; 2,0 mm; 16,0 cm	Joseph Delicate hook; 2,0 mm; 16,0 cm	125
118 91 0053	Joseph hák jemný; 5,0 mm; 16,0 cm	Joseph Delicate hook; 5,0 mm; 16,0 cm	125
118 91 0054	Joseph hák jemný; 7,0 mm; 16,0 cm	Joseph Delicate hook; 7,0 mm; 16,0 cm	125
118 91 0055	Joseph hák jemný; 10,0 mm; 16,0 cm	Joseph Delicate hook; 10,0 mm; 16,0 cm	125
118 91 0077	Desmarres držátko víček; 16,0 mm; 13,0 cm	Desmarres Delicatehook; 16,0 mm; 13,0 cm	126
118 91 0078	Desmarres držátko víček; 18,0 mm; 13,0 cm	Desmarres retractor; 18,0 mm; 13,0 cm	126
118 91 0097	Gil-Vernet hák páteřní jemný; 9,0 mm; 24,5 cm	Gil-Vernet spinalhook; 9,0 mm; 24,5 cm	126
118 91 0098	Gil-Vernet hák páteřní jemný; 11,0 mm; 24,5 cm	Gil-Vernet spinalhook; 11,0 mm; 24,5 cm	126
118 91 0100	Gil-Vernet hák páteřní jemný; 15,0 mm; 24,5 cm	Gil-Vernet spinalhook; 15,0 mm; 24,5 cm	126
118 91 0101	Gil-Vernet hák páteřní jemný; 18,0 mm; 24,5 cm	Gil-Vernet spinalhook; 18,0 mm; 24,5 cm	126
118 91 0109	Senn-Miller hák páteřní jemný ostrý; 16,0 cm	Senn-Miller spinalhook sharp; 16,0 cm	126
118 91 0110	Senn-Miller hák páteřní jemný tupý; 16,0 cm	Senn-Miller spinalhook blunt; 16,0 cm	126
118 91 0318	Bose hák na průdušnici levý; 16,0 cm	Bose trachea retractor left; 16,0 cm	133, 239
118 91 0319	Bose hák na průdušnici pravý; 16,0 cm	Bose trachea retractor right; 16,0 cm	133, 239

číslo – number	název	item	strana – page
118 91 0320	Iterson hák na průdušnici fig.1; 16,0 cm	Iterson trachea retractor fig.1; 16,0 cm	133
118 91 0321	Iterson hák na průdušnici fig.2; 16,0 cm	Iterson trachea retractor fig.2; 16,0 cm	133, 239
118 91 0323	Lukens hák na průdušnici; 17,0 cm	Lukens trachea hook; 17,0 cm	133
118 91 0324	Jackson hák na průdušnici fig.1; 18,0 cm	Jackson trachea hook fig.1; 18,0 cm	134
118 91 0325	Jackson hák na průdušnici fig.2; 18,0 cm	Jackson trachea hook fig.2; 18,0 cm	134
118 91 0326	Jackson hák na průdušnici 2-zubý; 17,0 cm	Jackson trachea hook 2 prongs; 17,0 cm	134
118 91 0327	Rose hák na průdušnici; 13,0 cm	Rose trachea hook; 13,0 cm	134
118 91 0328	Luer hák na průdušnici; 11,0 cm	Luer trachea hook; 11,0 cm	134
118 91 0329	Jackson hák na průdušnici; 15,0 cm	Jackson trachea hook; 15,0 cm	134
118 91 0330	News hák na průdušnici; 15,0 cm	News trachea hook; 15,0 cm	134
118 91 0331	Reichert hák na epiglottis; 24,0 cm	Reichert epiglottis retractor; 24,0 cm	134
118 91 0332	Cottle háček jemný; 16,0 cm	Cottle Delicate hook; 16,0 cm	128
118 91 0333	Fomon háček jemný tupý; 17,0 cm	Fomon Delicate hook blunt; 17,0 cm	128
118 91 0334	Lange háček jemný tupý; 22,0 cm	Lange Delicate hook blunt; 22,0 cm	128
118 91 0335	Fomon háček jemný 2-zubý; 16,0 cm	Fomon Delicate hook 2 prongs; 16,0 cm	128
118 91 0336	Freer háček jemný 2-zubý; 15,0 cm	Freer Delicate hook 2 prongs; 15,0 cm	128
118 91 0337	Cottle háček jemný 2-zubý ostrý; 14,0 cm	Cottle hook 2 prongs sharp; 14,0 cm	129
118 91 0338	Cottle háček jemný 2-zubý ostrý/tupý; 14,0 cm	Cottle hook 2 prongs sharp/blunt; 14,0 cm	129
118 91 0339	Cottle háček jemný 2-zubý ostrý/tupý; 14,0 cm	Cottle hook 2 prongs sharp/blunt; 14,0 cm	129
118 91 0340	Cottle(Millard) háček jemný 2-zubý	Cottle (Millard) Delicate hook 2 prongs	128
118 91 0341	Kilner háček jemný 2-zubý; 10,0 cm	Kilner Delicate hook 2 prongs; 10,0 cm	128
118 91 0342	Cottle háček jemný 4-zubý; 14,0 cm	Cottle Delicate hook 4 prongs; 14,0 cm	128
118 91 0343	Cottle-Neivert hák; 20,0 cm	Cottle-Neivert hook; 20,0 cm	129
118 91 0344	Converse hák; 12,0 cm	Converse hook; 12,0 cm	129
118 91 0345	Masing hák; 20,0 cm	Masing hook; 20,0 cm	129
118 91 0346	Cottle hák; 15,0 cm	Cottle hook; 15,0 cm	129
118 91 0347	Cottle hák; 15,0 cm	Cottle hook; 15,0 cm	129
118 91 0348	Aufricht (Walter) hák; 13,5 cm	Aufricht (Walter) hook; 13,5 cm	130
118 91 0349	Aufricht hák; 19,0 cm	Aufricht hook; 19,0 cm	130
118 91 0382	Hofer enucleator; 24,0 cm	Hofer enucleator; 24,0 cm	135
118 91 0383	Nager hák na mandle; 23,0 cm	Nager tonsil hook; 23,0 cm	135
118 91 0384	Love hák na mandle; 18 mm; 15,0 cm	Love tonsil hook; 18 mm; 15,0 cm	135
118 91 0385	Love hák na mandle; 20 mm; 15,0 cm	Love tonsil hook; 20 mm; 15,0 cm	135
118 91 0386	Love hák na mandle; 22 mm; 15,0 cm	Love tonsil hook; 22 mm; 15,0 cm	135
118 91 0387	Haslinger hák na mandle; 17,0 cm	Haslinger tonsil hook; 17,0 cm	135
118 91 0419	Hartmann háček ušní; 60×20 mm; 23,0 cm	Hartmann ear hook; 60×20 mm; 23,0 cm	127
118 91 0420	Zaufal háček ušní; 16,5 cm	Zaufal ear hook; 16,5 cm	127
118 91 0421	Wagener háček ušní fig.1; 14,0 cm	Wagener ear hook fig.1; 14,0 cm	127
118 91 0422	Wagener háček ušní fig.2; 14,0 cm	Wagener ear hook fig.2; 14,0 cm	127
118 91 0423	Wagener háček ušní fig.3; 14,0 cm	Wagener ear hook fig.3; 14,0 cm	127
118 91 0424	Wagener háček ušní fig.4; 14,0 cm	Wagener ear hook fig.4; 14,0 cm	127
119	ROZVĚRAČE	RETRACTORS	
119 07 0010	Roser-König rozvěrač úst; 19,5 cm	Roser-König mouth retractor; 19,5 cm	139
119 07 0020	Heister rozvěrač úst; 13,0 cm	Heister mouth retractor; 13,0 cm	139
119 08 0100	Weitlaner rozvěrač ran ostrý; 3×4 zuby; 13,0 cm	Weitlaner retractor 3×4 teeth sharp; 3×4 teeth; 13,0 cm	140
119 08 0110	Weitlaner rozvěrač ran tupý; 3×4 zuby; 13,0 cm	Weitlaner retractor 3×4 teeth blunt; 3×4 teeth; 13,0 cm	140
119 08 0680	Weitlaner rozvěrač ran ostrý; 4×3 zuby; 16,5 cm	Weitlaner retractor 4×3 teeth sharp; 4×3 teeth; 16,5 cm	140
119 08 0690	Weitlaner rozvěrač ran tupý; 4×3 zuby; 16,5 cm	Weitlaner retractor 4×3 teeth blunt; 4×3 teeth; 16,5 cm	140
119 08 1040	Weitlaner rozvěrač ran ostrý; 3×4 zuby; 13,5 cm	Weitlaner retractor 3×4 teeth sharp; 3×4 teeth; 13,5 cm	140
119 08 1060	Weitlaner rozvěrač ran tupý; 3×4 zuby; 13,5 cm	Weitlaner retractor 3×4 teeth blunt; 3×4 teeth; 13,5 cm	140
119 08 1120	Rozvěrač ran s lomen. rameny tupý; 3×4 zuby; 14,5 cm	Retractor 3×4 teeth blunt; 3×4 teeth; 14,5 cm	140
119 91 0001	Finsen rozvěrač ostrý; 2×3 zuby; 5,0 cm	Finsen retractor sharp 2×3 prongs; 2×3 teeth; 5,0 cm	139
119 91 0002	Finsen rozvěrač ostrý; 3×4 zuby; 7,0 cm	Finsen retractor sharp 3×4 prongs; 3×4 teeth; 7,0 cm	139
119 91 0003	Finsen rozvěrač tupý; 2×3 zuby; 5,0 cm	Finsen retractor blunt 2×3 prongs; 2×3 teeth; 5,0 cm	139
119 91 0004	Finsen rozvěrač tupý; 3×4 zuby; 7,0 cm	Finsen retractor blunt 3×4 prongs; 3×4 teeth; 7,0 cm	139
119 91 0013	Jansen rozvěrač ostrý; 4×4 zuby; 10,0 cm	Jansen retractor sharp 4×4 prongs; 4×4 teeth; 10,0 cm	139
119 91 0014	Jansen rozvěrač tupý; 4×4 zuby; 10,0 cm	Jansen retractor blunt 4×4 prongs; 4×4 teeth; 10,0 cm	139
119 91 0020	Weitlaner rozvěrač ostrý; 2×3 zuby; 10,5 cm	Weitlaner retractor sharp; 2×3 teeth; 10,5 cm	140
119 91 0021	Weitlaner rozvěrač tupý; 2×3 zuby; 10,5 cm	Weitlaner retractor blunt; 2×3 teeth; 10,5 cm	140
119 91 0026	Weitlaner rozvěrač ostrý; 3×4 zuby; 20,0 cm	Weitlaner retractor sharp; 3×4 teeth; 20,0 cm	140
119 91 0027	Weitlaner rozvěrač tupý; 3×4 zuby; 20,0 cm	Weitlaner retractor blunt; 3×4 teeth; 20,0 cm	140
119 91 0185	Jennings rozvěrač úst; 9,0 cm	Jennings mouth retractor; 9,0 cm	141
119 91 0186	Jennings rozvěrač úst; 11,0 cm	Jennings mouth retractor; 11,0 cm	141
119 91 0187	Jennings rozvěrač úst; 13,0 cm	Jennings mouth retractor; 13,0 cm	141
119 91 0188	Jennings rozvěrač úst; 15,0 cm	Jennings mouth retractor; 15,0 cm	141
119 91 0189	Whitehead rozvěrač úst; 9,0 cm	Whitehead mouth retractor; 9,0 cm	141
119 91 0190	Whitehead rozvěrač úst; 11,0 cm	Whitehead mouth retractor; 11,0 cm	141
119 91 0191	Whitehead rozvěrač úst; 13,0 cm	Whitehead mouth retractor; 13,0 cm	141
119 91 0192	Whitehead rozvěrač úst; 15,0 cm	Whitehead mouth retractor; 15,0 cm	141
119 91 0193	Whitehead rozvěrač úst; 9,0 cm	Whitehead mouth retractor; 9,0 cm	141

číslo – number	název	item	strana – page
119 91 0194	Whitehead rozvěrač úst; 11,0 cm	Whitehead mouth retractor; 11,0 cm	141
119 91 0195	Whitehead rozvěrač úst; 13,0 cm	Whitehead mouth retractor; 13,0 cm	141
119 91 0196	Whitehead rozvěrač úst; 15,0 cm	Whitehead mouth retractor; 15,0 cm	141
119 91 0197	Molt rozvěrač úst pro děti; 11,0 cm	Molt mouth retractor for children; 11,0 cm	139
119 91 0198	Molt rozvěrač úst pro dospělé; 14,0 cm	Molt mouth retractor for adults; 14,0 cm	139
119 91 0199	Denhart rozvěrač úst se západkou; 12,0 cm	Denhart mouth retractor; 12,0 cm	139
119 91 0200	Seemann-Seiffert rozvěrač úst; 9,0 cm	Seemann-Seiffert mouth retractor; 9,0 cm	142
119 91 0201	Seemann-Seiffert rozvěrač úst; 11,0 cm	Seemann-Seiffert mouth retractor; 11,0 cm	142
119 91 0202	Seemann-Seiffert rozvěrač úst; 13,0 cm	Seemann-Seiffert mouth retractor; 13,0 cm	142
119 91 0203	Seemann-Seiffert rozvěrač úst; 15,0 cm	Seemann-Seiffert mouth retractor; 15,0 cm	142
119 91 0204	Kilner-Doughty rozvěrač úst komplet	Kilner-Doughty mouth retractor complete	143
119 91 0205	Držák jazyka pro Kilner-Doughty fig.1	Tongue depressor f. Kilner-Doughty fig.1	143
119 91 0206	Držák jazyka pro Kilner-Doughty fig.2	Tongue depressor f. Kilner-Doughty fig.2	143
119 91 0207	Držák jazyka pro Kilner-Doughty fig.3	Tongue depressor f. Kilner-Doughty fig.3	143
119 91 0208	Rám pro rozvěrač úst Kilner-Doughty	Gag only for Kilner-Doughty mouth gag	143
119 91 0209	Držák patrový pro bezzubé	Palatal support for toothless	143
119 91 0210	Dingmann rozvěrač úst komplet	Dingmann mouth retractor set	143
119 91 0211	Držák jazyka pro Dingmann fig.1	Tongue depressor for Dingmann fig.1	143
119 91 0212	Držák jazyka pro Dingmann fig.2	Tongue depressor for Dingmann fig.2	143
119 91 0213	Držák jazyka pro Dingmann fig.3	Tongue depressor for Dingmann fig.3	143
119 91 0214	Rám pro rozvěrač Kilner-Doughty	Frame for Kilner-Doughty retractor	143
119 91 0215	Davis-Boyle rozvěrač úst komplet	Davis-Boyle mouth gag set	144
119 91 0216	Davis-Boyle lopatka fig.1; 105×27mm	Davis-Boyle tongue depressor fig.1; 105×27mm	144
119 91 0217	Davis-Boyle lopatka fig.2; 90×25 mm	Davis-Boyle tongue depressor fig.2; 90×25 mm	144
119 91 0218	Davis-Boyle lopatka fig.3; 75×25 mm	Davis-Boyle tongue depressor fig.3; 75×25 mm	144
119 91 0219	Davis-Boyle lopatka fig.4; 60×22 mm	Davis-Boyle tongue depressor fig.4; 60×22 mm	144
119 91 0220	Davis-Boyle lopatka fig.5; 25×20 mm	Davis-Boyle tongue depressor fig.5; 25×20 mm	144
119 91 0221	Rám pro rozvěrač úst Davis-Boyle	Gag only for Davis-Boyle	144
119 91 0222	MC Ivor rozvěrač úst komplet	MC Ivor mouth retractor set	142
119 91 0223	MC Ivor lopatka fig.1; 95×27 mm	MC Ivor blade fig. 1; 95×27 mm	142
119 91 0224	MC Ivor lopatka fig.2; 85×22 mm	MC Ivor blade fig. 2; 85×22 mm	142
119 91 0225	MC Ivor lopatka fig.3; 70×22 mm	MC Ivor blade fig. 3; 70×22 mm	142
119 91 0226	MC Ivor rám	MC Ivor frame	142
119 91 0227	Mod. Würzburg držák jazyka; 66×28 mm	Mod. Würzburg tongue depressor; 66×28 mm	144
119 91 0228	Mod. Würzburg držák jazyka; 75×32 mm	Mod. Würzburg tongue depressor; 75×32 mm	144
119 91 0229	Mod. Würzburg držák jazyka; 83×34 mm	Mod. Würzburg tongue depressor; 83×34 mm	144
119 91 0230	Mod. Würzburg držák jazyka; 93×37 mm	Mod. Würzburg tongue depressor; 93×37 mm	144
119 91 0231	Mod. Würzburg držák jazyka; 100×38 mm	Mod. Würzburg tongue depressor; 100×38 mm	144
119 91 0232	Negus podpora pro rozvěrač úst	Negus chest support for mouth gag	145
119 91 0233	Sternberg rozvěrač úst dvojitý; 12,0 cm	Sternberg lip retractor double; 12,0 cm	145
119 91 0234	Sternberg rozvěrač úst dvojitý; 14,0 cm	Sternberg lip retractor double; 14,0 cm	145
119 91 0235	Sternberg rozvěrač úst dvojitý; 16,0 cm	Sternberg lip retractor double; 16,0 cm	145
119 91 0236	Laborde rozvěrač; 14,0 cm	Laborde dilators; 14,0 cm	145
119 91 0237	Bose rozvěrač; 7,0 cm	Bose dilators; 7,0 cm	145, 239
121	LOPATKY	SPATULAS	
121 31 0010	Buchwald lopatka na jazyk; 16×23 mm; 17,3 cm	Buchwald tongue spatula; 16×23 mm; 17,3 cm	149
121 31 0020	Bruenings lopatka na jazyk; 14×18 mm; 19,5 cm	Bruenings tongue spatula; 14×18 mm; 19,5 cm	149
121 31 0040	Hartmann držák na jazyk; 15,0 cm	Hartmann tongue depressor; 15,0 cm	149
121 91 0013	Simplex držák na tváře; 11,0 cm	Simplex cheek retractor; 11,0 cm	149
121 91 0014	Tobold držák jazyka; 14,5 cm	Tobold tongue depressor hollow; 14,5 cm	149
121 91 0016	Moritz-Schmidt držák jazyka; 19,0 cm	Moritz-Schmidt tongue depressor; 19,0 cm	149
121 91 0017	Wieder držák na jazyk fig.1; 14,0 cm	Wieder tongue depressor fig.1; 14,0 cm	149
121 91 0018	Wieder držák na jazyk fig.2; 14,5 cm	Wieder tongue depressor fig.2; 14,5 cm	149
121 91 0019	Držák jazyka; 19,0 cm	Tongue depressor; 19,0 cm	150
121 91 0020	Standard držák jazyka; 14,5 cm	Standard tongue depressor; 14,5 cm	150
121 91 0021	Univ. Minnesota držák jazyka; 14,0 cm	Univ. Minnesota tongue depressor; 14,0 cm	150
121 91 0022	Kroenig držák jazyka; 15,0 cm	Kroenig tongue depressor; 15,0 cm	150
121 91 0023	Mayo držák jazyka; 17,0 cm	Mayo tongue depressor; 17,0 cm	150
121 91 0024	Bruenings držák jazyka; 19,0 cm	Bruenings tongue depressor; 19,0 cm	150
121 91 0025	Frenzel držák na jazyk; 16,5 cm	Frenzel tongue depressor; 16,5 cm	150
121 91 0026	Lopatka na jazyk; 18,0 cm	Tongue spatula; 18,0 cm	150
122	ZRCADLA	SPECULA	
122 30 0010	Hartmann zrcátko nosní fig.1; 6,0 mm	Hartmann nasal speculum fig.1; 6,0 mm	157
122 30 0020	Hartmann zrcátko nosní fig.2; 7,5 mm	Hartmann nasal speculum fig.2; 7,5 mm	157
122 30 0100	Killian zrcátko nosní fig.1; 42 mm	Killian nasal speculum fig.1; 42 mm	157
122 30 0110	Killian zrcátko nosní fig.2; 54 mm	Killian nasal speculum fig.2; 54 mm	157
122 30 0120	Killian zrcátko nosní fig.3; 75 mm	Killian nasal speculum fig.3; 75 mm	157
122 91 0172	Držátko zrcátek hrtanových	Handle for laryngeal mirrors	160
122 91 0173	Zrcátko hrtanové bez držátka fig.00; 8 mm	Laryngeal mirror w/o handle fig.00; 8 mm	160
122 91 0174	Zrcátko hrtanové bez držátka fig.0; 10 mm	Laryngeal mirror w/o handle fig.0; 10 mm	160

číslo – number	název	item	strana – page
122 91 0175	Zrcátko hrtanové bez držátka fig.1; 12 mm	Laryngeal mirror w/o handle fig.1; 12 mm	160
122 91 0176	Zrcátko hrtanové bez držátka fig.2; 14 mm	Laryngeal mirror w/o handle fig.2; 14 mm	160
122 91 0177	Zrcátko hrtanové bez držátka fig.3; 16 mm	Laryngeal mirror w/o handle fig.3; 16 mm	160
122 91 0178	Zrcátko hrtanové bez držátka fig.4; 18 mm	Laryngeal mirror w/o handle fig.4; 18 mm	160
122 91 0179	Zrcátko hrtanové bez držátka fig.5; 20 mm	Laryngeal mirror w/o handle fig.5; 20 mm	160
122 91 0180	Zrcátko hrtanové bez držátka fig.6; 22 mm	Laryngeal mirror w/o handle fig.6; 22 mm	160
122 91 0181	Zrcátko hrtanové bez držátka fig.7; 24 mm	Laryngeal mirror w/o handle fig.7; 24 mm	160
122 91 0182	Zrcátko hrtanové bez držátka fig.8; 26 mm	Laryngeal mirror w/o handle fig.8; 26 mm	160
122 91 0183	Zrcátko hrtanové bez držátka fig.9; 28 mm	Laryngeal mirror w/o handle fig.9; 28 mm	160
122 91 0184	Zrcátko hrtanové bez držátka fig.10; 30 mm	Laryngeal mirror w/o handle fig.10; 30 mm	160
122 91 0185	Zrcátko hrtanové s držátkem fig.00; 8 mm	Laryngeal mirror w/handle fig.00; 8 mm	160
122 91 0186	Zrcátko hrtanové s držátkem fig.0; 10 mm	Laryngeal mirror w/handle fig.0; 10 mm	160
122 91 0187	Zrcátko hrtanové s držátkem fig.1; 12 mm	Laryngeal mirror w/handle fig.1; 12 mm	160
122 91 0188	Zrcátko hrtanové s držátkem fig.2; 14 mm	Laryngeal mirror w/handle fig.2; 14 mm	160
122 91 0189	Zrcátko hrtanové s držátkem fig.3; 16 mm	Laryngeal mirror w/handle fig.3; 16 mm	160
122 91 0190	Zrcátko hrtanové s držátkem fig.4; 18 mm	Laryngeal mirror w/handle fig.4; 18 mm	160
122 91 0191	Zrcátko hrtanové s držátkem fig.5; 20 mm	Laryngeal mirror w/handle fig.5; 20 mm	160
122 91 0192	Zrcátko hrtanové s držátkem fig.6; 22 mm	Laryngeal mirror w/handle fig.6; 22 mm	160
122 91 0193	Zrcátko hrtanové s držátkem fig.7; 24 mm	Laryngeal mirror w/handle fig.7; 24 mm	160
122 91 0194	Zrcátko hrtanové s držátkem fig.8; 26 mm	Laryngeal mirror w/handle fig.8; 26 mm	160
122 91 0195	Zrcátko hrtanové s držátkem fig.9; 28 mm	Laryngeal mirror w/handle fig.9; 28 mm	160
122 91 0196	Zrcátko hrtanové s držátkem fig.10; 30 mm	Laryngeal mirror w/handle fig.10; 30 mm	160
122 91 0200	Politzer zrcátko ušní sada fig.1-3	Politzer ear speculum set fig.1-3	153
122 91 0201	Politzer zrcátko ušní fig.1; 2,0 mm	Politzer ear speculum fig.1; 2,0 mm	153
122 91 0202	Politzer zrcátko ušní fig.2; 3,0 mm	Politzer ear speculum fig.2; 3,0 mm	153
122 91 0203	Politzer zrcátko ušní fig.3; 4,0 mm	Politzer ear speculum fig.3; 4,0 mm	153
122 91 0204	Politzer zrcátko ušní fig.4; 5,0 mm	Politzer ear speculum fig.4; 5,0 mm	153
122 91 0205	Hartmann zrcátko ušní dětské sada fig.0-2	Hartmann f. children set fig.0-2	153
122 91 0206	Hartmann zrcátko ušní fig.0; 2,0 mm	Hartmann ear speculum fig.0; 2,0 mm	153
122 91 0207	Hartmann zrcátko ušní fig.1; 3,5 mm	Hartmann ear speculum fig.1; 3,5 mm	153
122 91 0208	Hartmann zrcátko ušní fig.2; 5,0 mm	Hartmann ear speculum fig.2; 5,0 mm	153
122 91 0209	Hartmann zrcátko ušní fig.3; 6,5 mm	Hartmann ear speculum fig.3; 6,5 mm	153
122 91 0210	Hartmann zrcátko ušní fig.4; 7,5 mm	Hartmann ear speculum fig.4; 7,5 mm	153
122 91 0211	Hartmann zrcátko ušní sada fig.2-4	Hartmann ear speculum set fig.2-4	153
122 91 0212	Hartmann zrcátko ušní sada fig.1-4	Hartmann ear speculum set fig.1-4	153
122 91 0213	Hartmann zrcátko ušní černé fig.0; 3,0 mm	Hartmann ear speculum black fig.0; 3,0 mm	153
122 91 0214	Hartmann zrcátko ušní černé fig.1; 4,0 mm	Hartmann ear speculum black fig.1; 4,0 mm	153
122 91 0215	Hartmann zrcátko ušní černé fig.2; 5,0 mm	Hartmann ear speculum black fig.2; 5,0 mm	153
122 91 0216	Hartmann zrcátko ušní černé fig.3; 7,0 mm	Hartmann ear speculum black fig.3; 7,0 mm	153
122 91 0217	Hartmann zrcátko ušní černé sada fig.0-3	Hartmann ear speculum black set fig.0-3	153
122 91 0218	Toynbee zrcátko ušní sada fig.2-4	Toynbee ear speculum set fig.2-4	153
122 91 0219	Toynbee zrcátko ušní sada fig.1-4	Toynbee ear speculum set fig.1-4	153
122 91 0220	Toynbee zrcátko ušní fig.1	Toynbee ear speculum fig.1	153
122 91 0221	Toynbee zrcátko ušní fig.2	Toynbee ear speculum fig.2	153
122 91 0222	Toynbee zrcátko ušní fig.3	Toynbee ear speculum fig.3	153
122 91 0223	Toynbee zrcátko ušní fig.4	Toynbee ear speculum fig.4	153
122 91 0224	Gruber zrcátko ušní sada fig.1-4	Gruber ear speculum set fig.1-4	154
122 91 0225	Gruber zrcátko ušní fig.1; 4,5 mm	Gruber ear speculum fig.1; 4,5 mm	154
122 91 0226	Gruber zrcátko ušní fig.2; 5,5 mm	Gruber ear speculum fig.2; 5,5 mm	154
122 91 0227	Gruber zrcátko ušní fig.3; 6,5 mm	Gruber ear speculum fig.3; 6,5 mm	154
122 91 0228	Gruber zrcátko ušní fig.4; 7,0 mm	Gruber ear speculum fig.4; 7,0 mm	154
122 91 0229	Zöllner zrcátko ušní alu black fig.1-6	Zöllner ear speculum alu black fig.1-6	154
122 91 0230	Zöllner zrcátko ušní; 5,5×6,5 mm; alu black	Zöllner ear speculum alu black; 5,5×6,5 mm	154
122 91 0231	Zöllner zrcátko ušní; 6,5×7,5 mm; alu black	Zöllner ear speculum alu black; 6,5×7,5 mm	154
122 91 0232	Zöllner zrcátko ušní; 7,5×8,5 mm; alu black	Zöllner ear speculum alu black; 7,5×8,5 mm	154
122 91 0233	Zöllner zrcátko ušní; 8,5×9,5 mm; alu black	Zöllner ear speculum alu black; 8,5×9,5 mm	154
122 91 0234	Zöllner zrcátko ušní; 9,5×10,5 mm; alu black	Zöllner ear speculum alu black; 9,5×10,5 mm	154
122 91 0235	Zöllner zrcátko ušní; 10,5×11,5 mm; alu black	Zöllner ear speculum alu black; 10,5×11,5 mm	154
122 91 0236	Boucheron zrcátko ušní sada fig.1-4	Boucheron ear speculum set fig.1-4	154
122 91 0237	Boucheron zrcátko ušní; 3,5 mm	Boucheron ear speculum; 3,5 mm	154
122 91 0238	Boucheron zrcátko ušní; 4,5 mm	Boucheron ear speculum; 4,5 mm	154
122 91 0239	Boucheron zrcátko ušní; 5,5 mm	Boucheron ear speculum; 5,5 mm	154
122 91 0240	Boucheron zrcátko ušní; 6,5 mm	Boucheron ear speculum; 6,5 mm	154
122 91 0241	Farrior zrcátko ušní; 3,3 mm	Farrior ear speculum; 3,3 mm	155
122 91 0242	Farrior zrcátko ušní; 4,3 mm	Farrior ear speculum; 4,3 mm	155
122 91 0243	Farrior zrcátko ušní; 4,8 mm	Farrior ear speculum; 4,8 mm	155
122 91 0244	Farrior zrcátko ušní; 5,3 mm	Farrior ear speculum; 5,3 mm	155
122 91 0245	Farrior zrcátko ušní; 5,8 mm	Farrior ear speculum; 5,8 mm	155
122 91 0246	Farrior zrcátko ušní; 6,3 mm	Farrior ear speculum; 6,3 mm	155
122 91 0247	Farrior zrcátko ušní; 6,7 mm	Farrior ear speculum; 6,7 mm	155

číslo – number	název	item	strana – page
122 91 0248	Farrior zrcátko ušní; 7,2 mm	Farrior ear speculum; 7,2 mm	155
122 91 0249	Farrior zrcátko ušní; 7,7 mm	Farrior ear speculum; 7,7 mm	155
122 91 0250	Farrior zrcátko ušní; 3,0×4,0 mm	Farrior ear speculum; 3,0×4,0 mm	155
122 91 0251	Farrior zrcátko ušní; 4,0×5,0 mm	Farrior ear speculum; 4,0×5,0 mm	155
122 91 0252	Farrior zrcátko ušní; 4,5×5,5 mm	Farrior ear speculum; 4,5×5,5 mm	155
122 91 0253	Farrior zrcátko ušní; 5,0×6,0 mm	Farrior ear speculum; 5,0×6,0 mm	155
122 91 0254	Farrior zrcátko ušní; 5,5×6,5 mm	Farrior ear speculum; 5,5×6,5 mm	155
122 91 0255	Farrior zrcátko ušní; 6,0×7,0 mm	Farrior ear speculum; 6,0×7,0 mm	155
122 91 0256	Farrior zrcátko ušní; 6,5×7,5 mm	Farrior ear speculum; 6,5×7,5 mm	155
122 91 0257	Farrior zrcátko ušní; 7,0×8,0 mm	Farrior ear speculum; 7,0×8,0 mm	155
122 91 0258	Farrior zrcátko ušní; 7,5×8,5 mm	Farrior ear speculum; 7,5×8,5 mm	155
122 91 0259	Farrior zrcátko ušní; 3,0×4,0 mm; 20°	Farrior ear speculum; 3,0×4,0 mm; 20°	155
122 91 0260	Farrior zrcátko ušní; 4,0×5,0 mm; 20°	Farrior ear speculum; 4,0×5,0 mm; 20°	155
122 91 0261	Farrior zrcátko ušní; 4,5×5,5 mm; 20°	Farrior ear speculum; 4,5×5,5 mm; 20°	155
122 91 0262	Farrior zrcátko ušní; 5,0×6,0 mm; 20°	Farrior ear speculum; 5,0×6,0 mm; 20°	155
122 91 0263	Farrior zrcátko ušní; 5,5×6,5 mm; 20°	Farrior ear speculum; 5,5×6,5 mm; 20°	155
122 91 0264	Farrior zrcátko ušní; 6,0×7,0 mm; 20°	Farrior ear speculum; 6,0×7,0 mm; 20°	155
122 91 0265	Farrior zrcátko ušní; 6,5×7,5 mm; 20°	Farrior ear speculum; 6,5×7,5 mm; 20°	155
122 91 0266	Farrior zrcátko ušní; 7,0×8,0 mm 20°	Farrior ear speculum; 7,0×8,0 mm 20°	155
122 91 0267	Farrior zrcátko ušní; 7,5×8,5 mm; 20°	Farrior ear speculum; 7,5×8,5 mm; 20°	155
122 91 0268	Farrior zrcátko ušní; 3,0×4,0 mm; 35°	Farrior ear speculum; 3,0×4,0 mm; 35°	155
122 91 0269	Farrior zrcátko ušní; 4,0×5,0 mm; 35°	Farrior ear speculum; 4,0×5,0 mm; 35°	155
122 91 0270	Farrior zrcátko ušní; 4,5×5,5 mm; 35°	Farrior ear speculum; 4,5×5,5 mm; 35°	155
122 91 0271	Farrior zrcátko ušní; 5,0×6,0 mm; 35°	Farrior ear speculum; 5,0×6,0 mm; 35°	155
122 91 0272	Farrior zrcátko ušní; 5,5×6,5 mm; 35°	Farrior ear speculum; 5,5×6,5 mm; 35°	155
122 91 0273	Farrior zrcátko ušní; 6,0×7,0 mm; 35°	Farrior ear speculum; 6,0×7,0 mm; 35°	155
122 91 0274	Farrior zrcátko ušní; 6,5×7,5 mm; 35°	Farrior ear speculum; 6,5×7,5 mm; 35°	155
122 91 0275	Farrior zrcátko ušní; 7,0×8,0 mm; 35°	Farrior ear speculum; 7,0×8,0 mm; 35°	155
122 91 0276	Farrior zrcátko ušní; 7,5×8,5 mm; 35°	Farrior ear speculum; 7,5×8,5 mm; 35°	155
122 91 0277	Bruenings otoskop komplet	Bruenings otoscope complete	156
122 91 0278	Bruenings zrcátko ušní fig.00; 2,0/4,0 mm	Bruenings ear speculum fig.00; 2,0/4,0 mm	156
122 91 0279	Bruenings zrcátko ušní fig.0; 3,0/4,8 mm	Bruenings ear speculum fig.0; 3,0/4,8 mm	156
122 91 0280	Bruenings zrcátko ušní fig.1; 4,0/6,0 mm	Bruenings ear speculum fig.1; 4,0/6,0 mm	156
122 91 0281	Bruenings zrcátko ušní fig.2; 5,0/7,0 mm	Bruenings ear speculum fig.2; 5,0/7,0 mm	156
122 91 0282	Bruenings zrcátko ušní fig.3; 6,5×8,5 mm	Bruenings ear speculum fig.3; 6,5×8,5 mm	156
122 91 0283	Bruenings zrcátko ušní fig.4; 8,5×10,5 mm	Bruenings ear speculum fig.4; 8,5×10,5 mm	156
122 91 0284	Bruenings zrcátko ušní fig.5; 10,5×12,5 mm	Bruenings ear speculum fig.5; 10,5×12,5 mm	156
122 91 0285	Hlava sací se zvětšováním	Suction head with magnification	156
122 91 0286	Bruenings žárovka s trubičkou pro otoskop	Bruenings rubber bulb only for otoscope	156
122 91 0287	Držák kovový pro 12 ušních zrcátek	Metal support for 12 ear specula	154
122 91 0288	Siegle otoskop komplet	Siegle otoscope set	156
122 91 0289	Siegle zrcátko ušní fig.1; 5,0/6,0 mm	Siegle ear speculum fig.1; 5,0/6,0 mm	156
122 91 0290	Siegle zrcátko ušní fig.2; 6,0/7,0 mm	Siegle ear speculum fig.2; 6,0/7,0 mm	156
122 91 0291	Siegle zrcátko ušní fig.3; 7,0/8,0 mm	Siegle ear speculum fig.3; 7,0/8,0 mm	156
122 91 0292	Trubička gumová se žárovkou pro siegle	Rubber tube and bulb only for siegle speculum	156
122 91 0293	Richnau Holmgren zrcátko ušní; 2 mm	Richnau Holmgren ear speculum; 2 mm	156
122 91 0294	Richnau Holmgren zrcátko ušní; 4 mm	Richnau Holmgren ear speculum; 4 mm	156
122 91 0295	Richnau Holmgren zrcátko ušní; 6 mm	Richnau Holmgren ear speculum; 6 mm	156
122 91 0296	Hartmann-Halle zrcátko nosní fig.1; 15,0 cm	Hartmann-Halle nasal speculum fig.1; 15,0 cm	158
122 91 0298	Hartmann-Halle zrcátko nosní fig.2; 15,0 cm	Hartmann-Halle nasal speculum fig.2; 15,0 cm	158
122 91 0300	Hartmann-Halle zrcátko nosní fig.3; 15,0 cm	Hartmann-Halle nasal speculum fig.3; 15,0 cm	158
122 91 0302	Hartmann zrcátko nosní fig.1; 15,0 cm	Hartmann nasal speculum fig.1; 15,0 cm	158
122 91 0304	Hartmann zrcátko nosní fig.2; 15,0 cm	Hartmann nasal speculum fig.2; 15,0 cm	158
122 91 0306	Hartmann zrcátko nosní fig.3; 15,0 cm	Hartmann nasal speculum fig.3; 15,0 cm	158
122 91 0308	Tieck-Halle zrcátko nosní fig.1; 13,5 cm	Tieck-Halle nasal speculum fig.1; 13,5 cm	158
122 91 0310	Tieck-Halle zrcátko nosní fig.2; 13,5 cm	Tieck-Halle nasal speculum fig.2; 13,5 cm	158
122 91 0328	Mod. Wien zrcátko nosní fig.1; 14,5 cm	Mod. Wien nasal speculum fig.1; 14,5 cm	158
122 91 0330	Mod. Wien zrcátko nosní fig.2; 14,5 cm	Mod. Wien nasal speculum fig.2; 14,5 cm	158
122 91 0332	Mod. Wien zrcátko nosní fig.3; 14,5 cm	Mod. Wien nasal speculum fig.3; 14,5 cm	158
122 91 0350	Thudichum (Goldsmith) zrcátko nosní fig.1; 6,5 cm	Thudichum nasal speculum fig.1; 6,5 cm	159
122 91 0351	Thudichum (Goldsmith) zrcátko nosní fig.1; 6,5 cm - černé	Thudichum nasal speculum fig.1 black; 6,5 cm - černé	159
122 91 0352	Thudichum (Goldsmith) zrcátko nosní fig.2; 6,5 cm	Thudichum nasal speculum fig.2; 6,5 cm	159
122 91 0353	Thudichum (Goldsmith) zrcátko nosní fig.2; 6,5 cm - černé	Thudichum nasal speculum fig.2 black; 6,5 cm - černé	159
122 91 0354	Thudichum (Goldsmith) zrcátko nosní fig.3; 6,5 cm	Thudichum nasal speculum fig.3; 6,5 cm	159
122 91 0355	Thudichum (Goldsmith) zrcátko nosní fig.3; 6,5 cm - černé	Thudichum nasal speculum fig.3 black; 6,5 cm - černé	159
122 91 0356	Voltolini (Duplay) zrcátko nosní fig.1	Voltolini (Duplay) nasal speculum fig.1	159
122 91 0357	Voltolini (Duplay) zrcátko nosní fig.1 - černé	Voltolini nasal speculum fig.1 black	159
122 91 0358	Voltolini (Duplay) zrcátko nosní fig.2	Voltolini (Duplay) nasal speculum fig.2	159
122 91 0359	Voltolini (Duplay) zrcátko nosní fig.2 - černé	Voltolini nasal speculum fig.2 black	159
122 91 0360	Voltolini (Duplay) zrcátko nosní fig.3	Voltolini (Duplay) nasal speculum fig.3	159

číslo – number	název	item	strana – page
122 91 0361	Voltolini (Duplay) zrcátko nosní fig.3 - černé	Voltolini nasal speculum fig.3 black	159
123	PÁČIDLA	ELEVATORS	
123 08 0010	Langenbeck páčidlo fig.1; 19,5 cm	Langenbeck elevator fig.1; 19,5 cm	166
123 08 0020	Langenbeck páčidlo fig.2; 19,5 cm	Langenbeck elevator fig.2; 19,5 cm	166
123 08 0030	Williger páčidlo fig.1; 16,0 cm	Williger elevator fig.1; 16,0 cm	166
123 29 0010	Páčka ušní zahnutá; 16,0 cm	Ear elevator; 16,0 cm	163
123 29 0020	Lucae páčka ušní; 2,0 mm; 15,0 cm	Lucae ear elevator; 2,0 mm; 15,0 cm	163
123 29 0030	Lucae páčka ušní; 3,0 mm; 15,0 cm	Lucae ear elevator; 3,0 mm; 15,0 cm	163
123 29 0040	Lucae páčka ušní; 4,0 mm; 15,0 cm	Lucae ear elevator; 4,0 mm; 15,0 cm	163
123 29 0080	Lucae páčka ušní lžičkovitá; 2,2 mm; 16,0 cm	Lucae ear elevator; 2,2 mm; 16,0 cm	163
123 30 0030	Freer páčidlo na nosní přepážku dvojité; 17,9 cm	Freer septum elevator; 17,9 cm	166
123 91 0001	McKenty páčidlo nosní 4,0 mm; 14,5 cm	McKenty nasal elevator; 14,5 cm	166
123 91 0002	McKenty páčidlo nosní 5,0 mm; 14,5 cm	McKenty nasal elevator; 14,5 cm	166
123 91 0003	Joseph-Masing páčidlo nosní; 22,0 cm	Joseph-Masing nasal elevator; 22,0 cm	166
123 91 0004	Halle páčidlo nosní; 16,5 cm	Halle nasal elevator; 16,5 cm	166
123 91 0005	Joseph páčidlo nosní; 16,0 cm	Joseph nasal elevator; 16,0 cm	166
123 91 0006	Freer páčidlo nosní ostré; 19,0 cm	Freer nasal elevator; 19,0 cm	164
123 91 0007	Freer páčidlo nosní tupé; 19,0 cm	Freer nasal elevator; 19,0 cm	164
123 91 0008	Freer páčidlo nosní ostro-tupé; 18,0cm	Freer nasal elevator; 18,0cm	164
123 91 0009	Cottle páčidlo nosní; 23,0 cm	Cottle nasal elevator; 23,0 cm	164
123 91 0010	Mckenty páčidlo nosní; 22,0 cm	Mckenty nasal elevator; 22,0 cm	164
123 91 0011	Cottle páčidlo nosní; 21,0 cm	Cottle nasal elevator; 21,0 cm	164
123 91 0012	Masing páčidlo nosní; 21,0 cm	Masing nasal elevator; 21,0 cm	165
123 91 0013	Howarth páčidlo nosní; 21,5 cm	Howarth nasal elevator; 21,5 cm	165
123 91 0014	Killian páčidlo nosní; 18,0 cm	Killian nasal elevator; 18,0 cm	165
123 91 0015	Killian páčidlo nosní; 22,0 cm	Killian nasal elevator; 22,0 cm	165
123 91 0016	Pierce páčidlo nosní; 21,0 cm	Pierce nasal elevator; 21,0 cm	165
123 91 0017	Pennington páčidlo nosní; 21,0 cm	Pennington nasal elevator; 21,0 cm	165
123 91 0018	Henke páčidlo na mandle; 23,0 cm	Henke dissector; 23,0 cm	167
123 91 0019	Henke páčidlo na mandle; 23,0 cm	Henke dissector; 23,0 cm	167
123 91 0020	Lopez-Reinke páčidlo na mandle; 23,0 cm	Lopez-Reinke dissector; 23,0 cm	167
123 91 0021	Shambaugh-Derlacki páčka ušní; 16,5 cm	Shambaugh-Derlacki ear elevator; 16,5 cm	163
123 91 0022	Lempert páčka ušní; 2,0 mm; 17,0 cm	Lempert ear elevator; 2,0 mm; 17,0 cm	163
123 91 0023	Lempert páčka ušní; 3,0 mm; 17,0 cm	Lempert ear elevator; 3,0 mm; 17,0 cm	163
123 91 0024	Lempert páčka ušní; 4,0 mm; 17,0 cm	Lempert ear elevator; 4,0 mm; 17,0 cm	163
123 91 0025	Lempert páčka ušní; 5,0 mm; 17,0 cm	Lempert ear elevator; 5,0 mm; 17,0 cm	163
124	ŠKRABKY	RASPATORIES	
124 08 0111	Williger škrabka fig.2; 16,0 cm	Williger raspatory fig.2; 16,0 cm	172
124 08 0250	Williger škrabka; 5,0 mm; 16,0 cm	Williger raspatory; 5,0 mm; 16,0 cm	172
124 08 0280	Williger škrabka rovná; 3,5 mm; 16,0 cm	Williger raspatory; 3,5 mm; 16,0 cm	172
124 08 0290	Williger škrabka zahnutá; 3,5 mm; 16,0 cm	Williger raspatory; 3,5 mm; 16,0 cm	172
124 29 0010	Hartmann škrabka ušní; 18,5 cm	Hartman ear raspatory; 18,5 cm	171
124 30 0020	Přecechtěl škrabka nosní; 19,0 cm	Přecechtěl nasal raspatory; 19,0 cm	172
124 32 0010	Hurd škrabka na mandle; 12×8 mm; 21,0 cm	Hurd tonsil raspatory; 12×8 mm; 21,0 cm	172
124 91 0001	Hurd škrabka nosní; 6 mm; 22,5 cm	Hurd nasal raspatory; 6 mm; 22,5 cm	172
124 91 0002	Hurd škrabka nosní; 10 mm; 22,5 cm	Hurd nasal raspatory; 10 mm; 22,5 cm	172
124 91 0003	Rosen škrabka; 1,5 mm; 19,0 cm	Rosen raspatory; 1,5 mm; 19,0 cm	171
124 91 0004	Rosen škrabka; 2,5 mm; 19,0 cm	Rosen raspatory; 2,5 mm; 19,0 cm	171
124 91 0005	Rosen škrabka fig.1; 16,0 cm	Rosen raspatory fig.1; 16,0 cm	171
124 91 0006	Rosen škrabka fig.2; 16,0 cm	Rosen raspatory fig.2; 16,0 cm	171
124 91 0007	Rosen škrabka fig.3; 16,0 cm	Rosen raspatory fig.3; 16,0 cm	171
124 91 0008	Rosen škrabka fig.4; 16,0 cm	Rosen raspatory fig.4; 16,0 cm	171
124 91 0009	Rosen škrabka fig.5; 16,0 cm	Rosen raspatory fig.5; 16,0 cm	171
124 91 0010	Rosen škrabka fig.6; 16,0 cm	Rosen raspatory fig.6; 16,0 cm	171
124 91 0011	Plester aplikátor; 16,0 cm	Plester application instrument; 16,0 cm	171
124 91 0012	Wullstein škrabka; 2,2 mm; 16,0 cm	Wullstein raspatory; 2,2 mm; 16,0 cm	171
124 91 0013	Wullstein škrabka; 3,2 mm; 16,0 cm	Wullstein raspatory; 3,2 mm; 16,0 cm	171
124 91 0014	Lempert škrabka; 3,0 mm; 16,0 cm	Lempert raspatory; 3,0 mm; 16,0 cm	171
125	LŽIČKY	SPOONS	
125 08 0110	Lžička ostrá oválná fig.000; 3,5 mm; 17,0 cm	Spoon sharp fig.000; 3,5 mm; 17,0 cm	176
125 08 0120	Lžička ostrá oválná fig.0; 4,8 mm; 17,2 cm	Spoon sharp fig.0; 4,8 mm; 17,2 cm	176
125 08 0130	Lžička ostrá oválná fig.1; 6,0 mm; 17,5 cm	Spoon sharp fig.1; 6,0 mm; 17,5 cm	176
125 08 0160	Lžička ostrá trepanační fig.1; 3,0 mm; 16,5 cm	Spoon sharp fig.1; 3,0 mm; 16,5 cm	176
125 08 0170	Lžička ostrá trepanační fig.2; 3,5 mm; 16,5 cm	Spoon sharp fig.2; 3,5 mm; 16,5 cm	176
125 08 0180	Lžička ostrá trepanační fig.3; 4,0 mm; 17,5 cm	Spoon sharp fig.3; 4,0 mm; 17,5 cm	176
125 08 0190	Lžička ostrá trepanační fig.4; 5,0 mm; 17,5 cm	Spoon sharp fig.4; 5,0 mm; 17,5 cm	176
125 08 0200	Lžička ostrá trepanační fig.5; 6,0 mm; 19,5 cm	Spoon sharp fig.5; 6,0 mm; 19,5 cm	176
125 30 0100	Halle lžička nosní; 6×4 mm; 23,0 cm	Halle nasal spoon; 6×4 mm; 23,0 cm	175
125 30 0110	Halle lžička nosní ostrá ohebná; 9×5 mm; 23,0 cm	Halle nasal spoon; 9×5 mm; 23,0 cm	175
125 91 0019	Barth lžička nosní; 18,0 cm	Barth nasal spoon; 18,0 cm	175

číslo – number	název	item	strana – page
125 91 0020	Jansen lžička nosní; 15,0 cm	Jansen nasal spoon; 15,0 cm	175
126	KYRETY	CURETTES	
126 32 0080	Smyčka drátěná; 0,3 mm; 4,8 cm	Wire loop for tonsil; 0,3 mm; 4,8 cm	187
126 32 0090	Smyčka drátěná; 0,4 mm; 4,8 cm	Wire loop for tonsil; 0,4 mm; 4,8 cm	187
126 32 0110	Smyčka drátěná; 0,5 mm; 4,8 cm	Wire loop for tonsil; 0,5 mm; 4,8 cm	187
126 32 0120	Smyčka drátěná; 0,3 mm; 4,0 cm	Wire loop for tonsil; 0,3 mm; 4,0 cm	187
126 32 0130	Smyčka drátěná; 0,4 mm; 4,5 cm	Wire loop for tonsil; 0,4 mm; 4,5 cm	187
126 32 0130	Smyčka drátěná; 0,4 mm; 4,0 cm	Wire loop for tonsil; 0,4 mm; 4,0 cm	187
126 32 0140	Smyčka drátěná; 0,5 mm; 4,0 cm	Wire loop for tonsil; 0,5 mm; 4,0 cm	187
126 91 0001	Bruenings skřípec na mandle; 28,0 cm	Bruenings tonsil snare; 28,0 cm	186
126 91 0010	Buck kyreta ušní ostrá zahnutá fig.000; 16,5 cm	Buck ear curette sharp curved fig.000; 16,5 cm	179
126 91 0011	Buck kyreta ušní ostrá zahnutá fig.00; 16,5 cm	Buck ear curette sharp curved fig.00; 16,5 cm	179
126 91 0012	Buck kyreta ušní ostrá zahnutá fig.0; 16,5 cm	Buck ear curette sharp curved fig.0; 16,5 cm	179
126 91 0013	Buck kyreta ušní ostrá zahnutá fig.1; 16,5 cm	Buck ear curette sharp curved fig.1; 16,5 cm	179
126 91 0014	Buck kyreta ušní ostrá zahnutá fig.2; 16,5 cm	Buck ear curette sharp curved fig.2; 16,5 cm	179
126 91 0015	Buck kyreta ušní ostrá zahnutá fig.3; 16,5 cm	Buck ear curette sharp curved fig.3; 16,5 cm	179
126 91 0016	Buck kyreta ušní ostrá zahnutá fig.4; 16,5 cm	Buck ear curette sharp curved fig.4; 16,5 cm	179
126 91 0017	Buck kyreta ušní ostrá zahnutá fig.5; 16,5 cm	Buck ear curette sharp curved fig.5; 16,5 cm	179
126 91 0018	Shapleigh kyreta ušní fig.1; 13,0 cm	Shapleigh ear curette fig.1; 13,0 cm	179
126 91 0019	Shapleigh kyreta ušní fig.2; 13,0 cm	Shapleigh ear curette fig.2; 13,0 cm	179
126 91 0020	Langenbeck kyreta ušní; 13,0 cm	Langenbeck ear curette; 13,0 cm	179
126 91 0100	Röder skřípec na mandle; 26,5 cm	Röder tonsil snare; 26,5 cm	188
126 91 0101	Sluder-Ballenger držadlo	Sluder-Ballenger handle only	185
126 91 0102	Sluder-Ballenger tonsillektom komplet	Sluder-Ballenger tonsillectome complete	185
126 91 0103	Sluder-Ballenger koncovka fig.1	Sluder-Ballenger tip fig. 1	185
126 91 0104	Sluder-Ballenger koncovka fig.2	Sluder-Ballenger tip fig. 2	185
126 91 0105	Sluder-Ballenger koncovka fig.3	Sluder-Ballenger tip fig. 3	185
126 91 0107	Eves skřípec na mandle; 28,0 cm	Eves tonsil snare; 28,0 cm	186
126 91 0108	Eves skřípec na mandle; 28,0 cm	Eves tonsil snare; 28,0 cm	186
126 91 0109	Tyding skřípec na mandle	Tyding tonsil snare	188
126 91 0110	Krause skřípec na ušní polypy; 16,0 cm	Krause polypus snare; 16,0 cm	181
126 91 0111	Krause-Voss skřípec na ušní polypy; 16,0 cm	Krause-Voss polypus snare; 16,0 cm	181
126 91 0112	Lange-Wilde skřípec na ušní polypy; 16,0 cm	Lange-Wilde polypus snare; 16,0 cm	181
126 91 0113	Drátek pro skřípec na ušní polypy; 0,3 mm	Wire for polypus snare; 0,3 mm	181
126 91 0114	Drátek pro skřípec na ušní polypy; 0,4 mm	Wire for polypus snare; 0,4 mm	181
126 91 0115	Smyčka drátěná; 0,2 mm (baleno po 12 ks)	Wire loop (pack of 12 pcs); 0,2 mm	181
126 91 0116	Smyčka drátěná; 0,3 mm (baleno po 12 ks)	Wire loop (pack of 12 pcs); 0,3 mm	181
126 91 0117	Smyčka drátěná; 0,2 mm (baleno po 100 ks)	Wire loop (pack of 100 pcs); 0,2 mm	181
126 91 0118	Smyčka drátěná; 0,3 mm (baleno po 100 ks)	Wire loop (pack of 100 pcs); 0,3 mm	181
126 91 0119	Billeau smyčka drátěná fig.1; 16,5 cm	Billeau loop fig.1; 16,5 cm	182
126 91 0120	Billeau smyčka drátěná fig.2; 16,5 cm	Billeau loop fig.2; 16,5 cm	182
126 91 0121	Billeau smyčka drátěná fig.3; 16,5 cm	Billeau loop fig.3; 16,5 cm	182
126 91 0122	Snellen smyčka drátěná fig.1; 16,5 cm	Snellen loop fig.1; 16,5 cm	182
126 91 0123	Snellen smyčka drátěná fig.2; 16,5 cm	Snellen loop fig.2; 16,5 cm	182
126 91 0124	Gross smyčka drátěná; 12,0 cm	Gross loop; 12,0 cm	182
126 91 0125	House kyreta ušní; 1,0×1,2 mm; 15,0 cm	House ear curette; 1,0×1,2 mm; 15,0 cm	180
126 91 0126	House kyreta ušní; 1,5×1,8 mm; 15,0 cm	House ear curette; 1,5×1,8 mm; 15,0 cm	180
126 91 0127	House kyreta ušní; 1,0×1,2 mm; 15,0 cm	House ear curette; 1,0×1,2 mm; 15,0 cm	180
126 91 0128	House kyreta ušní; 1,5×1,8 mm; 15,0 cm	House ear curette; 1,5×1,8 mm; 15,0 cm	180
126 91 0129	Shea kyreta ušní; 1,5×2,5 mm; 16,0 cm	Shea ear curette; 1,5×2,5 mm; 16,0 cm	180
126 91 0130	Shea kyreta ušní lomená; 1,5×2,5 mm; 16,0 cm	Shea ear curette angled; 1,5×2,5 mm; 16,0 cm	180
126 91 0131	Lempert kyreta fig.0; 17,5 cm	Lempert curette fig.0; 17,5 cm	180
126 91 0132	Lempert kyreta fig.00; 21,0 cm	Lempert curette fig.00; 21,0 cm	180
126 91 0133	Lempert kyreta fig.000; 21,0 cm	Lempert curette fig.000; 21,0 cm	180
126 91 0134	Lempert kyreta fig.0000; 21,0 cm	Lempert curette fig.0000; 21,0 cm	180
126 91 0135	Lempert kyreta fig.00000; 21,0 cm	Lempert curette fig.00000; 21,0 cm	180
126 91 0136	Krause štípek nosní; 26,0 cm	Krause nasal snare; 26,0 cm	183
126 91 0137	Krause-Voss štípek nosní; 26,0 cm	Krause-Voss nasal snare; 26,0 cm	183
126 91 0138	Lange-Wilde štípek nosní; 24,0 cm	Lange-Wilde nasal snare; 24,0 cm	183
126 91 0139	Smyčka drátěná; 0,3 mm; (baleno po 12 ks)	Wire loop (pack of 12 pcs.); 0,3 mm	183
126 91 0140	Drátek; 10,0 m; 0,3 mm	Wire; 10,0 m; 0,3 mm	183
126 91 0141	Drátek; 10,0 m; 0,4 mm	Wire; 10,0 m; 0,4 mm	183
126 91 0142	Coakley kyreta nosní ostrá fig.1; 17,0 cm	Coakley nasal curette sharp fig.1; 17,0 cm	184
126 91 0143	Coakley kyreta nosní ostrá fig.2; 17,0 cm	Coakley nasal curette sharp fig.2; 17,0 cm	184
126 91 0144	Coakley kyreta nosní ostrá fig.3; 17,0 cm	Coakley nasal curette sharp fig.3; 17,0 cm	184
126 91 0145	Coakley kyreta nosní ostrá fig.4; 17,0 cm	Coakley nasal curette sharp fig.4; 17,0 cm	184
126 91 0146	Coakley kyreta nosní ostrá fig.5; 17,0 cm	Coakley nasal curette sharp fig.5; 17,0 cm	184
126 91 0147	Coakley kyreta nosní ostrá fig.6; 17,0 cm	Coakley nasal curette sharp fig.6; 17,0 cm	184
126 91 0148	Faulkner kyreta nosní ostrá d/e; 21,0 cm	Faulkner nasal curette sharp d/e; 21,0 cm	184
126 91 0149	Sewall kyreta nosní ostrá; 20,0 cm	Sewall nasal curette sharp; 20,0 cm	184

číslo – number	název	item	strana – page
126 91 0150	Buck kyreta ušní tupá zahnutá fig.000; 16,5 cm	Buck ear curette blunt curved fig.000; 16,5 cm	179
126 91 0151	Buck kyreta ušní tupá zahnutá fig.00; 16,5 cm	Buck ear curette blunt curved fig.00; 16,5 cm	179
126 91 0152	Buck kyreta ušní tupá zahnutá fig.0; 16,5 cm	Buck ear curette blunt curved fig.0; 16,5 cm	179
126 91 0153	Buck kyreta ušní tupá zahnutá fig.1; 16,5 cm	Buck ear curette blunt curved fig.1; 16,5 cm	179
126 91 0154	Buck kyreta ušní tupá zahnutá fig.2; 16,5 cm	Buck ear curette blunt curved fig.2; 16,5 cm	179
126 91 0155	Buck kyreta ušní tupá zahnutá fig.3; 16,5 cm	Buck ear curette blunt curved fig.3; 16,5 cm	179
126 91 0156	Buck kyreta ušní tupá zahnutá fig.4; 16,5 cm	Buck ear curette blunt curved fig.4; 16,5 cm	179
126 91 0157	Buck kyreta ušní tupá zahnutá fig.5; 16,5 cm	Buck ear curette blunt curved fig.5; 16,5 cm	179
126 91 0160	Drátek na mandle (baleno po 12 ks)	Wire for tonsil (pack of 12 pcs.)	188
127	PILKY, PILNÍKY	SAWS, FILES	
127 08 0270	Škrabka vyhnutá; 15,9 cm	Rasp curved; 15,9 cm	191
127 30 0010	Holbroock-Curtis pilka nosní rovná; 18,0 cm	Holbroock-Curtis nasal saw; 18,0 cm	191
127 30 0100	Joseph pilník nosní fig.1; 16,5 cm	Joseph nasal rasp fig.1; 16,5 cm	191
127 30 0110	Joseph pilník nosní fig.2; 16,5 cm	Joseph nasal rasp fig.2; 16,5 cm	191
127 30 0120	Joseph pilník nosní fig.3; 16,5 cm	Joseph nasal rasp fig.3; 16,5 cm	191
127 30 0130	Joseph pilník nosní fig.4; 16,5 cm	Joseph nasal rasp fig.4; 16,5 cm	191
127 91 0010	Joseph pilka nosní levá; 17,0 cm	Joseph nasal saw left; 17,0 cm	192
127 91 0011	Joseph pilka nosní pravá; 17,0 cm	Joseph nasal saw right; 17,0 cm	192
127 91 0012	Joseph pilka nosní rovná; 19,0 cm	Joseph nasal saws straight; 19,0 cm	192
127 91 0013	Joseph pilka nosní vlevo vyhnutá; 19,0 cm	Joseph nasal saw bay-shape left; 19,0 cm	192
127 91 0014	Joseph pilka nosní vpravo vyhnutá; 19,0 cm	Joseph nasal saw bay-shape right; 19,0 cm	192
127 91 0015	Lewis pilník nosní fig.1; 18,0 cm	Lewis nasal rasp fig.1; 18,0 cm	193
127 91 0016	Lewis pilník nosní fig.2; 18,0 cm	Lewis nasal rasp fig.2; 18,0 cm	193
127 91 0017	Cottle pilník nosní; 21,0 cm	Cottle nasal rasp; 21,0 cm	193
127 91 0018	Aufricht pilník nosní fig.1; 21,0 cm	Aufricht nasal rasp fig.1; 21,0 cm	193
127 91 0019	Aufricht pilník nosní fig.2; 21,0 cm	Aufricht nasal rasp fig.2; 21,0 cm	193
127 91 0020	Maltz pilník nosní; 18,0 cm	Maltz nasal rasp; 18,0 cm	193
127 91 0021	Gallagher pilník nosní rovná; 16,0 cm	Gallagher nasal rasp straight; 16,0 cm	193
127 91 0022	Gallagher pilník nosní zahnutý vlevo; 16,0 cm	Gallagher nasal rasp curved left; 16,0 cm	193
127 91 0023	Gallagher pilník nosní zahnutý vpravo; 16,0 cm	Gallagher nasal rasp curved right; 16,0 cm	193
127 91 0024	Wiener pilník nosní fig.1; 18,0 cm	Wiener nasal rasp fig.1; 18,0 cm	194
127 91 0025	Wiener pilník nosní fig.2; 18,0 cm	Wiener nasal rasp fig.2; 18,0 cm	194
127 91 0026	Converse pilník nosní; 18,5 cm	Converse nasal rasp; 18,5 cm	194
127 91 0027	Fomon pilník nosní; 21,0 cm	Fomon nasal rasp; 21,0 cm	194
127 91 0028	Masing pilník nosní; 21,0 cm	Masing nasal rasp; 21,0 cm	194
127 91 0029	Masing pilník nosní; 21,0 cm	Masing nasal rasp; 21,0 cm	194
127 91 0030	Miller-Colburn pilník nosní fig.1; 19,0 cm	Miller-Colburn nasal rasp fig.1; 19,0 cm	195
127 91 0031	Miller-Colburn pilník nosní fig.2; 19,0 cm	Miller-Colburn nasal rasp fig.2; 19,0 cm	195
127 91 0032	Miller-Colburn pilník nosní fig.3; 19,0 cm	Miller-Colburn nasal rasp fig.3; 19,0 cm	195
127 91 0033	Miller-Colburn pilník nosní fig.4; 19,0 cm	Miller-Colburn nasal rasp fig.4; 19,0 cm	195
127 91 0034	Miller-Colburn pilník nosní fig.5; 19,0 cm	Miller-Colburn nasal rasp fig.5; 19,0 cm	195
127 91 0035	Miller-Colburn pilník nosní fig.1; 19,0 cm	Miller-Colburn nasal rasp fig.1; 19,0 cm	195
127 91 0036	Miller-Colburn pilník nosní fig.2; 19,0 cm	Miller-Colburn nasal rasp fig.2; 19,0 cm	195
127 91 0037	Miller-Colburn pilník nosní fig.3; 19,0 cm	Miller-Colburn nasal rasp fig.3; 19,0 cm	195
127 91 0038	Miller-Colburn pilník nosní fig.4; 19,0 cm	Miller-Colburn nasal rasp fig.4; 19,0 cm	195
127 91 0039	Miller-Colburn pilník nosní fig.5; 19,0 cm	Miller-Colburn nasal rasp fig.5; 19,0 cm	195
127 91 0040	Lewis pilník nosní tvrdokovový fig. 1; 18,0 cm	Lewis nasal rasp fig.1 tuc; 18,0 cm	196
127 91 0041	Lewis pilník nosní tvrdokovový fig. 2; 18,0 cm	Lewis nasal rasp fig.2 tuc; 18,0 cm	196
127 91 0042	Cottle pilník nosní tvrdokovový; 21,0 cm	Cottle nasal rasp tuc; 21,0 cm	196
127 91 0043	Fomon pilník nosní tvrdokovový fig. 1; 20,0 cm	Fomon nasal rasp fig.1 tuc; 20,0 cm	196
127 91 0044	Fomon pilník nosní tvrdokovový fig. 2; 20,0 cm	Fomon nasal rasp fig.2 tuc; 20,0 cm	196
127 91 0045	Fomon pilník nosní tvrdokovový fig. 3; 20,0 cm	Fomon nasal rasp fig.3 tuc; 20,0 cm	196
127 91 0046	Fomon pilník nosní tvrdokovový fig. 4; 20,0 cm	Fomon nasal rasp fig.4 tuc; 20,0 cm	196
127 91 0047	Fomon pilník nosní tvrdokovový fig. 5; 20,0 cm	Fomon nasal rasp fig.5 tuc; 20,0 cm	196
128	DLÁTA, KLADIVA	CHISELS, MALLETS	
128 08 0901	Kladívko chirurgické kovové; 250 g	Mallet metallic; 250 g	206
128 08 0911	Williger kladívko chirurgické kovové; 500 g	Williger mallet metallic; 500 g	206
128 12 0100	Dláto na nosní plastiku fig.1; 190×4 mm	Nasal plastic chisel fig.1; 190×4 mm	200
128 12 0110	Dláto na nosní plastiku fig.1; 190×6 mm	Nasal plastic chisel fig.1; 190×6 mm	200
128 12 0120	Dláto na nosní plastiku; 190×10 mm	Nasal plastic chisel; 190×10 mm	200
128 12 0130	Dláto na nosní plastiku; 190×12 mm	Nasal plastic chisel; 190×12 mm	200
128 12 0140	Dláto na nosní plastiku; 190×14 mm	Nasal plastic chisel; 190×14 mm	200
128 12 0160	Dláto na nosní plastiku fig.2; 180×4 mm	Nasal plastic chisel fig.2; 180×4 mm	200
128 12 0170	Dláto na nosní plastiku fig.2; 180×6 mm	Nasal plastic chisel fig.2; 180×6 mm	200
128 12 0180	Dláto na nosní plastiku fig.2; 180×10 mm	Nasal plastic chisel fig.2; 180×10 mm	200
128 12 0190	Dláto na nosní plastiku fig.2; 180×12 mm	Nasal plastic chisel fig.2; 180×12 mm	200
128 12 0270	Dláto na nosní plastiku vyhnuté fig.1; 190×10 mm	Nasal plastic chisel curved fig.1; 190×10 mm	200
128 12 0280	Dláto na nosní plastiku vyhnuté fig.1; 190×12 mm	Nasal plastic chisel curved fig.1; 190×12 mm	200
128 12 0290	Dláto na nosní plastiku vyhnuté fig.1; 190×14 mm	Nasal plastic chisel curved fig.1; 190×14 mm	200
128 12 0500	Dláto na jemné kosti; 10,0 mm; 15,5 cm	Gouge for fine bones; 10,0 mm; 15,5 cm	201

číslo – number	název	item	strana – page
128 29 0410	Stacke dláto ušní žlábkové dopředu zahnuté; 140×4 mm	Stacke ear gouge; 140×4 mm	199
128 29 0420	Stacke dláto ušní žlábkové dopředu zahnuté; 140×6 mm	Stacke ear gouge; 140×6 mm	199
128 29 0430	Stacke dláto ušní žlábkové dopředu zahnuté; 140×8 mm	Stacke ear gouge; 140×8 mm	199
128 29 0440	Stacke dláto ušní žlábkové dopředu zahnuté; 140×10 mm	Stacke ear gouge; 140×10 mm	199
128 29 0510	Stacke dláto ušní žlábkové dozadu zahnuté; 140×4 mm	Stacke ear gouge; 140×4 mm	199
128 29 0520	Stacke dláto ušní žlábkové dozadu zahnuté; 140×6 mm	Stacke ear gouge; 140×6 mm	199
128 29 0530	Stacke dláto ušní žlábkové dozadu zahnuté; 140×8 mm	Stacke ear gouge; 140×8 mm	199
128 29 0540	Stacke dláto ušní žlábkové dozadu zahnuté; 140×10 mm	Stacke ear gouge; 140×10 mm	199
128 29 0750	Stacke chránič dlátek; 15,0 cm	Stacke chisel guide; 15,0 cm	199
128 30 0010	Dláto žlábkové nosní; 180×2 mm	Nasal gouge; 180×2 mm	201
128 30 0030	Dláto žlábkové nosní; 180×4 mm	Nasal gouge; 180×4 mm	201
128 30 0040	Dláto žlábkové nosní; 180×5 mm	Nasal gouge; 180×5 mm	201
128 30 0200	West dláto ploché nosní; 180×2 mm	West nasal chisel; 180×2 mm	201
128 30 0230	West dláto ploché nosní; 180×5 mm	West nasal chisel; 180×5 mm	201
128 91 0159	Hajek kladívko; 140 g; 18,0 cm	Hajek mallet; 140 g; 18,0 cm	206
128 91 0160	Freer dláto nosní; 16,0 cm	Freer nasal chisel; 16,0 cm	202
128 91 0161	Freer dláto nosní; 16,0 cm	Freer nasal chisel; 16,0 cm	202
128 91 0162	West dláto nosní; 16,0 cm	West nasal chisel; 16,0 cm	202
128 91 0163	West dláto nosní; 16,0 cm	West nasal chisel; 16,0 cm	202
128 91 0164	Freer dláto nosní; 15,0 cm	Freer nasal chisel; 15,0 cm	202
128 91 0166	Ballenger dláto nosní; 6,0 mm; 16,0 cm	Ballenger nasal chisel; 6,0 mm; 16,0 cm	202
128 91 0168	Killian-Claus dláto nosní; 16,0 cm	Killian-Claus nasal chisel; 16,0 cm	202
128 91 0169	Killian-Claus dláto nosní; 17,0 cm	Killian-Claus nasal chisel; 17,0 cm	202
128 91 0170	Cottle dláto nosní; 4,0 mm; 18,0 cm	Cottle osteotome; 4,0 mm; 18,0 cm	203
128 91 0171	Cottle dláto nosní; 7,0 mm; 18,0 cm	Cottle osteotome; 7,0 mm; 18,0 cm	203
128 91 0172	Cottle dláto nosní; 9,0 mm; 18,0 cm	Cottle osteotome; 9,0 mm; 18,0 cm	203
128 91 0173	Cottle dláto nosní; 12,0 mm; 18,0 cm	Cottle osteotome; 12,0 mm; 18,0 cm	203
128 91 0174	Cottle dláto nosní zahnuté; 6,0 mm; 18,0 cm	Cottle osteotome curved; 6,0 mm; 18,0 cm	203
128 91 0175	Cottle dláto nosní; 6,0 mm; 18,0 cm	Cottle osteotome; 6,0 mm; 18,0 cm	203
128 91 0176	Cottle dláto nosní; 4,0 mm; 18,0 cm	Cottle chisel; 4,0 mm; 18,0 cm	203
128 91 0177	Cottle dláto nosní; 7,0 mm; 18,0 cm	Cottle chisel; 7,0 mm; 18,0 cm	203
128 91 0178	Cottle dláto nosní; 9,0 mm; 18,0 cm	Cottle chisel; 9,0 mm; 18,0 cm	203
128 91 0179	Cottle dláto nosní; 12,0 mm; 18,0 cm	Cottle chisel; 12,0 mm; 18,0 cm	203
128 91 0180	Cottle dláto nosní; 16,0 mm; 18,0 cm	Cottle osteotome; 16,0 mm; 18,0 cm	203
128 91 0181	Cottle dláto nosní; 16,0 mm; 18,0 cm	Cottle osteotome; 16,0 mm; 18,0 cm	203
128 91 0182	Walter dláto nosní; 3 mm; 19,0 cm	Walter chisel; 3 mm; 19,0 cm	204
128 91 0183	Walter dláto nosní; 4,5 mm; 19,0 cm	Walter chisel; 4,5 mm; 19,0 cm	204
128 91 0184	Walter dláto nosní; 3 mm; 19,0 cm	Walter osteotome; 3 mm; 19,0 cm	204
128 91 0185	Walter dláto nosní; 4 mm; 19,0 cm	Walter osteotome; 4 mm; 19,0 cm	204
128 91 0186	Walter dláto nosní; 7 mm; 19,0 cm	Walter osteotome; 7 mm; 19,0 cm	204
128 91 0187	Walter dláto nosní; 9 mm; 19,0 cm	Walter osteotome; 9 mm; 19,0 cm	204
128 91 0188	Walter dláto nosní; 12 mm; 19,0 cm	Walter osteotome; 12 mm; 19,0 cm	204
128 91 0189	Sheehan dláto; 7 mm; 17,0 cm	Sheehan osteotome; 7 mm; 17,0 cm	204
128 91 0190	Sheehan dláto; 8 mm; 17,0 cm	Sheehan osteotome; 8 mm; 17,0 cm	204
128 91 0191	Sheehan dláto; 10 mm; 17,0 cm	Sheehan osteotome; 10 mm; 17,0 cm	204
128 91 0192	Sheehan dláto; 12 mm; 17,0 cm	Sheehan osteotome; 12 mm; 17,0 cm	204
128 91 0193	Rubin dláto; 10 mm; 18,0 cm	Rubin osteotome; 10 mm; 18,0 cm	204
128 91 0194	Rubin dláto; 12 mm; 18,0 cm	Rubin osteotome; 12 mm; 18,0 cm	204
128 91 0195	Rubin dláto; 14 mm; 18,0 cm	Rubin osteotome; 14 mm; 18,0 cm	204
128 91 0196	Cinelli dláto; 16 mm; 18,0 cm	Cinelli osteotome; 16 mm; 18,0 cm	204
128 91 0197	Masing dláto nosní; 17,5 cm	Masing chisel; 17,5 cm	205
128 91 0198	Masing dláto nosní rovné; 17,5 cm	Masing osteotome straight; 17,5 cm	205
128 91 0199	Masing dláto nosní fig.1; 17,5 cm	Masing osteotome fig.1; 17,5 cm	205
128 91 0200	Masing dláto nosní fig.2; 17,5 cm	Masing osteotome fig.2; 17,5 cm	205
128 91 0201	Silver dláto nosní rovné; 18,0 cm	Silver chisel straight; 18,0 cm	205
128 91 0202	Silver dláto nosní fig.0; 18,0 cm	Silver chisel fig.0; 18,0 cm	205
128 91 0203	Silver dláto nosní fig.2; 18,0 cm	Silver chisel fig.2; 18,0 cm	205
128 91 0204	Neivert dláto nosní rovné; 20,0 cm	Neivert chisel straight; 20,0 cm	205
128 91 0205	Anderson-Neivert dláto nosní fig.1; 20,0 cm	Anderson-Neivert chisel fig.1; 20,0 cm	205
128 91 0206	Anderson-Neivert dláto nosní fig.2; 20,0 cm	Anderson-Neivert chisel fig.2; 20,0 cm	205
128 91 0207	Converse dláto nosní fig.0; 19,0 cm	Converse chisel fig.0; 19,0 cm	205
128 91 0208	Converse dláto nosní fig.1; 19,0 cm	Converse chisel fig.1; 19,0 cm	205
128 91 0209	Converse dláto nosní fig.2; 19,0 cm	Converse chisel fig.2; 19,0 cm	205
128 91 0210	Kladívko; 140 g; 18,0 cm	Mallet; 140 g; 18,0 cm	206
128 91 0211	Koncovky kovové; pár	Ferrozell faces only	206
128 91 0212	Cottle kladívko; 240 g; 18,0 cm	Cottle mallet; 240 g; 18,0 cm	206
131	FRÉZY, VRTÁKY	DRILLS, BURS	
131 29 0010	Fréza pro orl; 3,0 mm	Ent bur; 3,0 mm	209
131 29 0020	Fréza pro orl; 3,5 mm	Ent bur; 3,5 mm	209
131 29 0030	Fréza pro orl; 4,0 mm	Ent bur; 4,0 mm	209

číslo – number	název	item	strana – page
131 29 0040	Fréza pro orl; 4,5 mm	Ent bur; 4,5 mm	209
131 29 0050	Fréza pro orl; 5,0 mm	Ent bur; 5,0 mm	209
131 29 0100	Fréza pro orl; 5,0 mm	Ent bur; 5,0 mm	209
131 29 0120	Fréza pro orl; 7,0 mm	Ent bur; 7,0 mm	209
131 29 0200	Fréza pro orl; 5,0 mm	Ent bur; 5,0 mm	209
131 29 0450	Fréza pro orl; 2,7 mm	Ent bur; 2,7 mm	209
131 29 0460	Fréza pro orl; 3,1 mm	Ent bur; 3,1 mm	209
131 29 0470	Fréza pro orl; 3,5 mm	Ent bur; 3,5 mm	209
132	JEHLY, JEHELCE	NEEDLES, NEEDLE HOLDERS	
132 06 0300	Crile jehelec jemný; 15,0 cm	Crile needle holder; 15,0 cm	214
132 06 0310	Crile jehelec jemný; 15,5 cm	Crile needle holder; 15,5 cm	214
132 06 0341	Jehelec hloubkový rovný provlékací zámek; 16,5 cm	Needle holder; 16,5 cm	215
132 06 0370	Crile jehelec jemný diamant; 1,6 mm; 15,5 cm	Crile needle holder dia; 1,6 mm; 15,5 cm	216
132 06 0450	Crile jehelec jemný provlékací zámek (vložka sk); 16,2 cm	Crile needle holder tuc; 16,2 cm	216
132 06 0520	Mathieu jehelec provlékací zámek (vložka sk); 14,0 cm	Mathieu needle holder tuc; 14,0 cm	217
132 06 0590	Jehelec jemný rovný (vložka sk); 13,0 cm	Needle holder tuc; 13,0 cm	216
132 06 0600	Ryder/French-Eye jehelec; 16,5 cm	Ryder/French-Eye needle holder; 16,5 cm	217
132 06 0610	Jehelec hloubkový rovný (vložka sk); 16,5 cm	Needle holder tuc; 16,5 cm	216
132 06 0710	Bozemann jehelec hloubk. prohnutý (vložka sk); 16,0 cm	Needle holder tuc; 16,0 cm	218
132 06 0720	Bozemann jehelec hloubk. prohnutý (vložka sk); 20,0 cm	Needle holder tuc; 20,0 cm	218
132 06 0730	Bozemann jehelec hloubk. prohnutý (vložka sk); 25,0 cm	Needle holder tuc; 25,0 cm	218
132 12 0011	Jehelec pro plastiku prohnutý; 16,2 cm	Needle holder for plastic surgery; 16,2 cm	214
132 12 0020	Jehelec pro plastiku prohnutý; 21,0 cm	Needle holder for plastic surgery; 21,0 cm	214
132 38 0120	Boynton jehelec oční; 12,5 cm	Boynton eye needle holder; 12,5 cm	214
132 50 0180	Luniatschek zavaděč drenů; 17,0 cm	Luniatschek drain introducer; 17,0 cm; 17,0 cm	213
132 50 0186	Luniatschek zavaděč drenů; 16,7 cm	Luniatschek drain introducer; 16,7 cm; 16,7 cm	213
132 50 0196	Luniatschek zavaděč drenů se žlábkem; 16,7 cm	Luniatschek drain introducer with groove; 16,7 cm; 16,7 cm	213
132 56 0186	Luniatschek zavaděč drenů; 16,8 cm	Luniatschek drain introducer hollow handle; 16,8 cm; 16,8 cm	213
132 56 0196	Luniatschek zavaděč drenů se žlábkem; 16,8 cm	Luniatschek drain introducer hollow handle; 16,8 cm; 16,8 cm	213
132 91 0050	Olsen-Hegar jehelec/nůžky; 14,0 cm	Olsen-Hegar needle holder/scissors; 14,0 cm	215
132 91 0051	Olsen-Hegar jehelec/nůžky; 17,0 cm	Olsen-Hegar needle holder/scissors; 17,0 cm	215
132 91 0052	Olsen-Hegar jehelec/nůžky; 19,0 cm	Olsen-Hegar needle holder/scissors; 19,0 cm	215
132 91 0133	Derf jehelec tvrdokov; 12,5 cm	Derf needle holder tuc; 12,5 cm	216
132 91 0135	Kilner jehelec s-prohnutý tvrdokov; 13,5 cm	Kilner needle holder tuc; 13,5 cm	217
132 91 0138	Halsey jehelec tvrdokov hladký; 13,0 cm	Halsey needle holder tuc; 13,0 cm	217
132 91 0139	Halsey jehelec tvrdokov; 13,0 cm	Halsey needle holder tuc; 13,0 cm	217
132 91 0140	Baby-Crile-Wood jehelec tvrdokov; 15,0 cm	Baby-Crile-Wood needle holder tuc; 15,0 cm	217
132 91 0142	Crile-Wood jehelec tvrdokov; 15,0 cm	Crile-Wood needle holder tuc; 15,0 cm	217
132 91 0160	Olsen-Hegar jehelec/nůžky tvrdokov; 14,0 cm	Olsen-Hegar needle holder/scissors tuc; 14,0 cm	218
132 91 0161	Olsen-Hegar jehelec/nůžky tvrdokov; 17,0 cm	Olsen-Hegar needle holder/scissors tuc; 17,0 cm	218
132 91 0401	Yankauer jehla nosní fig.1; 18,0 cm	Yankauer nasal needle fig.1; 18,0 cm	213
132 91 0402	Yankauer jehla nosní fig.2; 18,0 cm	Yankauer nasal needle fig.2; 18,0 cm	213
132 91 0403	Yankauer jehla nosní fig.3; 18,0 cm	Yankauer nasal needle fig.3; 18,0 cm	213
132 91 0404	Yankauer jehla nosní fig.4; 18,0 cm	Yankauer nasal needle fig.4; 18,0 cm	213
132 91 0405	Yankauer jehla nosní fig.5; 18,0 cm	Yankauer nasal needle fig.5; 18,0 cm	213
132 91 0406	Yankauer jehla nosní fig.6; 18,0 cm	Yankauer nasal needle fig.6; 18,0 cm	213
132 91 0407	Yankauer jehla nosní fig.7; 18,0 cm	Yankauer nasal needle fig.7; 18,0 cm	213
132 91 0408	Yankauer jehla nosní fig.8; 18,0 cm	Yankauer nasal needle fig.8; 18,0 cm	213
132 91 0409	Yankauer jehla nosní fig.9; 18,0 cm	Yankauer nasal needle fig.9; 18,0 cm	213
133	PÁTRADLA	PROBES	
133 08 0020	Pátradlo paličkové oboustranné; 15,0 cm	Probe olive; 15,0 cm	221
133 08 0050	Pátradlo paličkové oboustranné; 20,0 cm	Probe olive; 20,0 cm	221
133 08 0060	Pátradlo paličkové oboustranné; 25,0 cm	Probe olive; 25,0 cm	221
133 08 0100	Pátradlo paličkové s dlátkem; 15,0 cm	Probe olive with chisel; 15,0 cm	221
133 08 0110	Pátradlo paličkové s dlátkem; 20,0 cm	Probe olive with chisel; 20,0 cm	221
133 08 0120	Pátradlo paličkové s dlátkem; 25,0 cm	Probe olive with chisel; 25,0 cm	221
133 08 0140	Pátradlo paličkové; 14,5 cm	Probe; 14,5 cm	222
133 29 0010	Pátradlo ušní; 1,0 mm; 9,5 cm	Aural probe; 1,0 mm; 9,5 cm	222
133 29 0110	Drátek pro výtěry; 0,8 mm; 14,0 cm	Swab wire; 0,8 mm; 14,0 cm	223
133 30 0030	Pátradlo nosní; 1,6 mm; 13,7 cm	Nasal probe; 1,6 mm; 13,7 cm	222
133 31 0050	Držák rovný; 1,5 mm; 16,7 cm	Straight holder; 1,5 mm; 16,7 cm	224
133 31 0060	Držák šikmý; 2,0 mm; 16,0 cm	Angled holder; 2,0 mm; 16,0 cm	224
133 31 0070	Držák kruhový zahnutý; 1,5 mm; 15,0 cm	Round curved holder; 1,5 mm; 15,0 cm	224
133 31 0100	Sada logopedických nástrojů	Set of instruments for logopaedia	224
133 35 0010	Kocher pátradlo na strumu; 15,5 cm	Kocher goitre probe; 15,5 cm	223
133 91 0028	Sonda žlábková; 13,0 cm	Grooved director; 13,0 cm; 13,0 cm	239
133 91 0165	Kocher pátradlo na strumu fig.1; 15,0 cm	Kocher goitre probe fig.1; 15,0 cm	223
133 91 0166	Kocher pátradlo na strumu fig.1; 16,0 cm	Kocher goitre probe fig.1; 16,0 cm	223
133 91 0167	Kocher pátradlo na strumu fig.2; 15,0 cm	Kocher goitre probe fig.2; 15,0 cm	223
133 91 0168	Kocher pátradlo na strumu fig.2; 16,0 cm	Kocher goitre probe fig.2; 16,0 cm	223

číslo – number	název	item	strana – page
133 91 0169	Kocher pátradlo na strumu fig.3; 18,0 cm	Kocher goitre probe fig.3; 18,0 cm	223
133 91 0170	Lucae pátradlo háčkové fig.1; 14,0 cm	Lucae hooklet fig.1; 14,0 cm	221
133 91 0171	Lucae pátradlo háčkové fig.2; 14,0 cm	Lucae hooklet fig.2; 14,0 cm	221
133 91 0172	Lucae pátradlo háčkové fig.3; 14,0 cm	Lucae hooklet fig.3; 14,0 cm	221
133 91 0173	Fisch disektor fig.1; 16,0 cm	Fisch dissector fig.1; 16,0 cm	221
133 91 0174	Fisch disektor fig.2; 16,0 cm	Fisch dissector fig.2; 16,0 cm	221
133 91 0175	Fisch disektor fig.3; 16,0 cm	Fisch dissector fig.3; 16,0 cm	221
133 91 0176	Fisch disektor fig.4; 16,0 cm	Fisch dissector fig.4; 16,0 cm	221
133 91 0177	House pátradlo měřicí; 3,5 mm; 16,0 cm	House measuring probe; 3,5 mm; 16,0 cm	221
133 91 0178	House pátradlo měřicí; 4,0 mm; 16,0 cm	House measuring probe; 4,0 mm; 16,0 cm	221
133 91 0179	House pátradlo měřicí; 4,5 mm; 16,0 cm	House measuring probe; 4,5 mm; 16,0 cm	221
133 91 0180	House pátradlo měřicí; 5,0 mm; 16,0 cm	House measuring probe; 5,0 mm; 16,0 cm	221
134	TROKARY, ODSÁVAČKY	TROCARS, SUCTION TUBES	
134 08 0080	Držadlo bez regulace	Handle without regulation	228
134 08 0090	Držadlo s regulací	Handle with regulation	228
134 08 0100	Odsávačka oblouková mikro; 1 mm; 13,0 cm	Suction tube; 1 mm; 13,0 cm	228
134 08 0110	Odsávačka oblouková mikro; 2 mm; 13,0 cm	Suction tube; 2 mm; 13,0 cm	228
134 08 0120	Odsávačka oblouková mikro; 3 mm; 13,0 cm	Suction tube; 3 mm; 13,0 cm	228
134 08 0130	Odsávačka oblouková mikro; 4 mm; 14,5 cm	Suction tube; 4 mm; 14,5 cm	228
134 08 0140	Odsávačka oblouková mikro; 5 mm; 14,5 cm	Suction tube; 5 mm; 14,5 cm	228
134 08 0150	Odsávačka oblouková mikro; 6 mm; 14,5 cm	Suction tube; 6 mm; 14,5 cm	228
134 08 0200	Odsávačka oblouková mikro; 1 mm; 15,0 cm	Suction tube; 1 mm; 15,0 cm	228
134 08 0210	Odsávačka oblouková mikro; 2 mm; 15,0 cm	Suction tube; 2 mm; 15,0 cm	228
134 08 0220	Odsávačka oblouková mikro; 3 mm; 15,0 cm	Suction tube; 3 mm; 15,0 cm	228
134 08 0230	Odsávačka oblouková mikro; 4 mm; 16,5 cm	Suction tube; 4 mm; 16,5 cm	228
134 08 0240	Odsávačka oblouková mikro; 5 mm; 16,5 cm	Suction tube; 5 mm; 16,5 cm	228
134 08 0250	Odsávačka oblouková mikro; 6 mm; 16,5 cm	Suction tube; 6 mm; 16,5 cm	228
134 08 0300	Odsávačka lomená mikro; 1 mm; 8,0 cm	Suction tube; 1 mm; 8,0 cm	228
134 08 0310	Odsávačka lomená mikro; 2 mm; 8,0 cm	Suction tube; 2 mm; 8,0 cm	228
134 08 0320	Odsávačka lomená mikro; 1 mm; 12,0 cm	Suction tube; 1 mm; 12,0 cm	228
134 08 0330	Odsávačka lomená mikro; 2 mm; 12,0 cm	Suction tube; 2 mm; 12,0 cm	228
134 08 0400	Odsávačka silně zahnutá mikro; 1 mm; 9,0 cm	Suction tube; 1 mm; 9,0 cm	228
134 08 0410	Odsávačka silně zahnutá mikro; 2 mm; 9,0 cm	Suction tube; 2 mm; 9,0 cm	228
134 08 0420	Odsávačka silně zahnutá mikro; 3 mm; 9,0 cm	Suction tube; 3 mm; 9,0 cm	228
134 08 0430	Odsávačka silně zahnutá mikro; 4 mm; 9,0 cm	Suction tube; 4 mm; 9,0 cm	228
134 08 0440	Odsávačka silně zahnutá mikro; 5 mm; 9,0 cm	Suction tube; 5 mm; 9,0 cm	228
134 08 0500	Odsávačka silně zahnutá mikro; 1 mm; 12,0 cm	Suction tube; 1 mm; 12,0 cm	228
134 08 0510	Odsávačka silně zahnutá mikro; 2 mm; 12,0 cm	Suction tube; 2 mm; 12,0 cm	228
134 08 0520	Odsávačka silně zahnutá mikro; 3 mm; 12,0 cm	Suction tube; 3 mm; 12,0 cm	228
134 08 0530	Odsávačka silně zahnutá mikro; 4 mm; 12,0 cm	Suction tube; 4 mm; 12,0 cm	228
134 08 0540	Odsávačka silně zahnutá mikro; 5 mm; 12,0 cm	Suction tube; 5 mm; 12,0 cm	228
134 08 0600	Odsávačka silně zahnutá mikro; 1 mm; 16,0 cm	Suction tube; 1 mm; 16,0 cm	228
134 08 0610	Odsávačka silně zahnutá mikro; 2 mm; 16,0 cm	Suction tube; 2 mm; 16,0 cm	228
134 08 0620	Odsávačka silně zahnutá mikro; 3 mm; 16,0 cm	Suction tube; 3 mm; 16,0 cm	228
134 08 0630	Odsávačka silně zahnutá mikro; 4 mm; 16,0 cm	Suction tube; 4 mm; 16,0 cm	228
134 08 0640	Odsávačka silně zahnutá mikro; 5 mm; 16,0 cm	Suction tube; 5 mm; 16,0 cm	228
134 29 0010	Jehla punkční; 2,0 mm; 11,4 cm	Puncture needle; 2,0 mm; 11,4 cm	227
134 29 0020	Jehla punkční; 2,5 mm; 11,4 cm	Puncture needle; 2,5 mm; 11,4 cm	227
134 29 0030	Jehla punkční; 3,0 mm; 11,4 cm	Puncture needle; 3,0 mm; 11,4 cm	227
134 29 0040	Jehla punkční; 3,5 mm; 11,4 cm	Puncture needle; 3,5 mm; 11,4 cm	227
134 29 0050	Jehla punkční; 1,5 mm; 11,4 cm	Puncture needle; 1,5 mm; 11,4 cm	227
134 91 0176	Uckermann trokar; 7,5 mm; 13,0 cm	Uckermann trocar; 7,5 mm; 13,0 cm	227
134 91 0177	Uckermann trokar; 9,0 mm; 13,0 cm	Uckermann trocar; 9,0 mm; 13,0 cm	227
134 91 0178	Luer kanyla tracheální fig.0; 4 mm	Luer trachea tube fig.0; 4 mm	232
134 91 0179	Luer kanyla tracheální fig.1; 5 mm	Luer trachea tube fig.1; 5 mm	232
134 91 0180	Luer kanyla tracheální fig.2; 6 mm	Luer trachea tube fig.2; 6 mm	232
134 91 0181	Luer kanyla tracheální fig.3; 7 mm	Luer trachea tube fig.3; 7 mm	232, 239
134 91 0182	Luer kanyla tracheální fig.4; 8 mm	Luer trachea tube fig.4; 8 mm	232, 239
134 91 0183	Luer kanyla tracheální fig.5; 9 mm	Luer trachea tube fig.5; 9 mm	232
134 91 0184	Luer kanyla tracheální fig.6; 10 mm	Luer trachea tube fig.6; 10 mm	232
134 91 0185	Luer kanyla tracheální fig.7; 11 mm	Luer trachea tube fig.7; 11 mm	232
134 91 0186	Luer kanyla tracheální fig.8; 12 mm	Luer trachea tube fig.8; 12 mm	232
134 91 0187	Luer kanyla tracheální fig.9; 13 mm	Luer trachea tube fig.9; 13 mm	232
134 91 0188	Chevalier-Jackson kanyla tracheální; 4 mm	Chevalier-Jackson trachea tube; 4 mm	232
134 91 0189	Chevalier-Jackson kanyla tracheální; 5 mm	Chevalier-Jackson trachea tube; 5 mm	232
134 91 0190	Chevalier-Jackson kanyla tracheální; 6 mm	Chevalier-Jackson trachea tube; 6 mm	232
134 91 0191	Chevalier-Jackson kanyla tracheální; 7 mm	Chevalier-Jackson trachea tube; 7 mm	232
134 91 0192	Chevalier-Jackson kanyla tracheální; 8 mm	Chevalier-Jackson trachea tube; 8 mm	232
134 91 0193	Chevalier-Jackson kanyla tracheální; 9 mm	Chevalier-Jackson trachea tube; 9 mm	232
134 91 0194	Chevalier-Jackson kanyla tracheální; 10 mm	Chevalier-Jackson trachea tube; 10 mm	232

číslo – number	název	item	strana – page
134 91 0195	Chevalier-Jackson kanyla tracheální; 11 mm	Chevalier-Jackson trachea tube; 11 mm	232
134 91 0196	Chevalier-Jackson kanyla tracheální; 12 mm	Chevalier-Jackson trachea tube; 12 mm	232
134 91 0197	Chevalier-Jackson kanyla tracheální; 13 mm	Chevalier-Jackson trachea tube; 13 mm	232
134 91 0198	Kanyla tracheální fig.4; 8 mm	Speaking tube fig.4; 8 mm	232
134 91 0199	Kanyla tracheální fig.5; 9 mm	Speaking tube fig.5; 9 mm	232
134 91 0200	Kanyla tracheální fig.6; 10 mm	Speaking tube fig.6; 10 mm	232
134 91 0201	Kanyla tracheální fig.7; 11 mm	Speaking tube fig.7; 11 mm	232
134 91 0202	Kanyla tracheální fig.8; 12 mm	Speaking tube fig.8; 12 mm	232
134 91 0203	Kanyla tracheální fig.9; 13 mm	Speaking tube fig.9; 13 mm	232
134 91 0204	House odsávačka 0,9×0,7 mm	House suction tube	231
134 91 0205	House odsávačka 1,2×0,9 mm	House suction tube	231
134 91 0206	House odsávačka 1,5×1,2 mm	House suction tube	231
134 91 0207	House odsávačka 1,8×1,8 mm	House suction tube	231
134 91 0208	House odsávačka 2,5×2,0 mm	House suction tube	231
134 91 0209	House odsávačka 3,0×2,0 mm	House suction tube	231
134 91 0210	House odsávačka 4,5×2,0 mm	House suction tube	231
134 91 0211	Baron (Schuknecht) odsávačka 1,0×75 mm	Baron (Schuknecht) suction tube	231
134 91 0212	Baron (Schuknecht) odsávačka 1,5×75 mm	Baron (Schuknecht) suction tube	231
134 91 0213	Baron (Schuknecht) odsávačka 2,0×75 mm	Baron (Schuknecht) suction tube	231
134 91 0214	Zöllner odsávačka	Zöllner suction tube	231
134 91 0215	Kanyla sací; 0,5 mm	Suction cannula only; 0,5 mm	231
134 91 0216	Kanyla sací; 0,7 mm	Suction cannula only; 0,7 mm	231
134 91 0217	Wullstein držadlo	Wullstein handle only	231
134 91 0218	Wullstein spojka	Wullstein tube connection piece	231
134 91 0219	House odsávačka; 0,6 mm	House suction tube; 0,6 mm	231
134 91 0220	House odsávačka; 0,8 mm	House suction tube; 0,8 mm	231
134 91 0221	House odsávačka; 1,0 mm	House suction tube; 1,0 mm	231
134 91 0222	House odsávačka; 1,2 mm	House suction tube; 1,2 mm	231
134 91 0223	House odsávačka; 1,5 mm	House suction tube; 1,5 mm	231
134 91 0224	House odsávačka; 1,8 mm	House suction tube; 1,8 mm	231
134 91 0225	House odsávačka; 2,0 mm	House suction tube; 2,0 mm	231
134 91 0226	House odsávačka; 2,2 mm	House suction tube; 2,2 mm	231
134 91 0227	House odsávačka; 2,5 mm	House suction tube; 2,5 mm	231
134 91 0228	House odsávačka; 3,0 mm	House suction tube; 3,0 mm	231
134 91 0229	Hartmann katetr ušní fig.0; 14,0 cm	Hartmann ear catheter fig.0; 14,0 cm	231
134 91 0230	Hartmann katetr ušní fig.1; 14,0 cm	Hartmann ear catheter fig.1; 14,0 cm	231
134 91 0231	Hartmann katetr ušní fig.2; 14,0 cm	Hartmann ear catheter fig.2; 14,0 cm	231
134 91 0232	Hartmann katetr ušní fig.3; 14,0 cm	Hartmann ear catheter fig.3; 14,0 cm	231
134 91 0233	Hartmann katetr ušní fig.4; 14,0 cm	Hartmann ear catheter fig.4; 14,0 cm	231
134 91 0234	Hartmann katetr ušní fig.5; 14,0 cm	Hartmann ear catheter fig.5; 14,0 cm	231
134 99 0029	Odsávačka zahnutá s olivkou - Luer; 2,5 mm; 12,5 cm	Suction tube with regulation and olive; 2,5 mm; 12,5 cm	229
134 99 0126	Odsávačka s regulací a olivkou; 1,5 mm; 10,0 cm	Suction tube with regulation and olive; 1,5 mm; 10,0 cm	230
134 99 0128	Odsávačka s regulací a olivkou; 2,0 mm; 5,0 cm	Suction tube with regulation and olive; 2,0 mm; 5,0 cm	230
134 99 0129	Odsávačka s regulací a olivkou; 2,0 mm; 8,0 cm	Suction tube with regulation and olive; 2,0 mm; 8,0 cm	230
134 99 0130	Odsávačka s regulací a olivkou; 2,0 mm; 10,0 cm	Suction tube with regulation and olive; 2,0 mm; 10,0 cm	230
134 99 0131	Odsávačka s regulací a olivkou; 2,0 mm; 12,0 cm	Suction tube with regulation and olive; 2,0 mm; 12,0 cm	230
134 99 0132	Odsávačka s regulací a olivkou; 3,0 mm; 5,0 cm	Suction tube with regulation and olive; 3,0 mm; 5,0 cm	230
134 99 0133	Odsávačka s regulací a olivkou; 3,0 mm; 8,0 cm	Suction tube with regulation and olive; 3,0 mm; 8,0 cm	230
134 99 0134	Odsávačka s regulací a olivkou; 3,0 mm; 10,0 cm	Suction tube with regulation and olive; 3,0 mm; 10,0 cm	230
134 99 0156	Kanyla s olivkou lomená - Luer; 1,2 mm; 8,5 cm	Suction tube with olive - Luer; 1,2 mm; 8,5 cm	229
134 99 0157	Kanyla s olivkou lomená - Luer; 1,5 mm; 8,5 cm	Suction tube with olive - Luer; 1,5 mm; 8,5 cm	229
134 99 0164	Odsávačka lomená - Luer; 2 mm; 8,5 cm	Suction tube - Luer; 2 mm; 8,5 cm	229
134 99 0175	Přechodka - Luer	Connecting piece - Luer	229
134 99 0186	Kanyla osazená lomená - Luer; 0,6 mm; 8,6 cm	Suction tube - Luer; 0,6 mm; 8,6 cm	229
134 99 0246	Kanyla s olivkou rovná - Luer; 1,2 mm; 8,0 cm	Suction tube - Luer; 1,2 mm; 8,0 cm	229
134 99 0247	Kanyla s olivkou rovná - Luer; 1,5 mm; 8,0 cm	Suction tube - Luer; 1,5 mm; 8,0 cm	229
134 99 0267	Odsávačka s regulací a olivkou; 1,5 mm; 8,0 cm	Suction tube with regulation and olive; 1,5 mm; 8,0 cm	230
134 99 0268	Odsávačka s regulací a olivkou; 1,0 mm; 10,0 cm	Suction tube with regulation and olive; 1,0 mm; 10,0 cm	230
134 99 0307	Odsávačka s regulací a olivkou; 2,0 mm; 10,0 cm	Suction tube with regulation and olive; 2,0 mm; 10,0 cm	230
134 99 0308	Odsávačka s regulací a olivkou; 2,0 mm; 8,0 cm	Suction tube with regulation and olive; 2,0 mm; 8,0 cm	230
134 99 0309	Odsávačka s regulací a olivkou; 1,5 mm; 8,0 cm	Suction tube with regulation and olive; 1,5 mm; 8,0 cm	230
134 99 0310	Odsávačka s regulací a olivkou; 1,5 mm; 5,0 cm	Suction tube with regulation and olive; 1,5 mm; 5,0 cm	230
134 99 0314	Kanyla s olivkou rovná - Luer; 1,5 mm; 10,0 cm	Suction tube - Luer; 1,5 mm; 10,0 cm	229
134 99 0315	Kanyla s olivkou rovná - Luer; 1,2 mm; 10,0 cm	Suction tube - Luer; 1,2 mm; 10,0 cm	229
134 99 0562	Kanyla laryngeální; 2,5 mm; 13,0 cm	Laryngeal cannula; 2,5 mm; 13,0 cm	229
134 99 0563	Kanyla laryngeální; 2,5 mm; 15,0 cm	Laryngeal cannula; 2,5 mm; 15,0 cm	229
136	NÁSTROJE SPECIÁLNÍ	SPECIAL INSTRUMENTS	
136 91 0001	Langenbeck chránič prstu; 2,20 cm	Langenbeck finger protector; 2,20 cm	238
136 91 0002	Langenbeck chránič prstu; 2,45 cm	Langenbeck finger protector; 2,45 cm	238
136 91 0003	Langenbeck chránič prstu; 2,65 cm	Langenbeck finger protector; 2,65 cm	238

číslo – number	název	item	strana – page
136 91 0043	Maunder závaží do úst; 10,0 cm	Maunder oral wedge; 10,0 cm	238
136 91 0044	Pitha závaží do úst; 9,0 cm	Pitha oral wedge; 9,0 cm	238
136 91 0045	Buckingham nástroj ruční na ušní kůstku fig.1; 16,0 cm	Buckingham footplate hand instrument fig.1; 16,0 cm	235
136 91 0046	Buckingham nástroj ruční na ušní kůstku fig.2; 16,0 cm	Buckingham footplate hand instrument fig.2; 16,0 cm	235
136 91 0047	Buckingham nástroj ruční na ušní kůstku fig.3; 16,0 cm	Buckingham footplate hand instrument fig.3; 16,0 cm	235
136 91 0048	Larkin nástroj ruční na ušní kůstku fig.1; 16,0 cm	Larkin footplate hand instrument fig.1; 16,0 cm	235
136 91 0049	Larkin nástroj ruční na ušní kůstku fig.2; 16,0 cm	Larkin footplate hand instrument fig.2; 16,0 cm	235
136 91 0050	Larkin nástroj ruční na ušní kůstku fig.3; 16,0 cm	Larkin footplate hand instrument fig.3; 16,0 cm	235
136 91 0051	Heermann držadlo; 17,0 cm	Heermann handle; 17,0 cm	235
136 91 0052	Nástroj ruční na ušní kůstku; 0,7 mm	Footplate hand instrument; 0,7 mm	235
136 91 0053	Nástroj ruční na ušní kůstku; 0,7 mm	Footplate hand instrument; 0,7 mm	235
136 91 0054	Nástroj ruční na ušní kůstku; 1,0 mm	Footplate hand instrument; 1,0 mm	235
136 91 0055	Nástroj ruční na ušní kůstku; 1,5 mm	Footplate hand instrument; 1,5 mm	235
136 91 0056	Nástroj ruční na ušní kůstku; 3,0 mm	Footplate hand instrument; 3,0 mm	235
136 91 0057	Nástroj ruční na ušní kůstku; 19,5 cm	Footplate hand instrument; 19,5 cm	235
136 91 0058	Kanyla pro ušní stříkačku	Cannula for ear syringe	236
136 91 0059	Součástka pro ušní stříkačku	Element for ear syringe	236
136 91 0060	Disk ochrany pro ušní stříkačku	Protecting disk for ear syringe	236
136 91 0061	Stříkačka ušní komplet; 50 ml	Ear syringe set; 50 ml	236
136 91 0062	Stříkačka ušní komplet; 75 ml	Ear syringe set; 75 ml	236
136 91 0063	Stříkačka ušní komplet; 100 ml	Ear instrument set; 100 ml	236
136 91 0064	Přehrádka sterilizační	Sterilization stand	241
136 91 0065	Přehrádka sterilizační; 19,0×9,6×3,0 cm	Sterilization stand; 19,0×9,6×3,0 cm	241
136 91 0066	Přehrádka sterilizační; 19,0×9,6×3,0 cm	Sterilization stand; 19,0×9,6×3,0 cm	241
136 91 0067	Přehrádka sterilizační; 19,0×9,6×3,0 cm	Sterilization stand; 19,0×9,6×3,0 cm	241
136 91 0068	Set pro tracheotomii	Tracheotomy set	239
136 91 0077	Miska; 0,05 l; 4,0×1,9 cm	Bowl; 0,05 l; 4,0×1,9 cm	240
136 91 0078	Miska; 0,07 l; 6,1×3,0 cm	Bowl; 0,07 l; 6,1×3,0 cm	240
136 91 0079	Miska; 0,14 l; 8,0×4,0 cm	Bowl; 0,14 l; 8,0×4,0 cm	240
136 91 0080	Miska; 0,35 l; 11,6×5,0 cm	Bowl; 0,35 l; 11,6×5,0 cm	240
136 91 0081	Miska; 0,45 l; 12,8×5,5 cm	Bowl; 0,45 l; 12,8×5,5 cm	240
136 91 0082	Miska; 0,70 l; 14,7×6,5 cm	Bowl; 0,70 l; 14,7×6,5 cm	240
136 91 0087	Miska; 17,0 cm	Bowl; 17,0 cm	240
136 91 0088	Miska; 25,0 cm	Bowl; 25,0 cm	240
136 91 0089	Miska; 27,5 cm	Bowl; 27,5 cm	240
136 91 0153	Janet stříkačka; 50 ml	Janet syringe; 50 ml	237
136 91 0154	Janet stříkačka; 100 ml	Janet syringe; 100 ml	237
136 91 0155	Janet stříkačka; 150 ml	Janet syringe; 150 ml	237
136 91 0156	Janet stříkačka; 200 ml	Janet syringe; 200 ml	237
136 91 0157	Stříkačka; 50 ml	Syringe; 50 ml	237
136 91 0158	Stříkačka; 100 ml	Syringe; 100 ml	237
136 91 0159	Stříkačka; 150 ml	Syringe; 150 ml	237
136 91 0160	Stříkačka; 200 ml	Syringe; 200 ml	237
146	NÁSTROJE DIAMANTOVANÉ	DIAMOND INSTRUMENTS	
146 29 0010	Brousek diamantovaný; 0,8 mm; 7,0 cm	Diamond instrument; 0,8 mm; 7,0 cm	245
146 29 0030	Brousek diamantovaný; 1,0 mm; 7,0 cm	Diamond instrument; 1,0 mm; 7,0 cm	245
146 29 0050	Brousek diamantovaný; 1,4 mm; 7,0 cm	Diamond instrument; 1,4 mm; 7,0 cm	245
146 29 0070	Brousek diamantovaný; 1,8 mm; 7,0 cm	Diamond instrument; 1,8 mm; 7,0 cm	245
146 29 0090	Brousek diamantovaný; 2,3 mm; 7,0 cm	Diamond instrument; 2,3 mm; 7,0 cm	245
146 29 0120	Brousek diamantovaný; 2,9 mm; 9,5 cm	Diamond instrument; 2,9 mm; 9,5 cm	245
146 29 0130	Brousek diamantovaný; 3,1 mm; 9,5 cm	Diamond instrument; 3,1 mm; 9,5 cm	245
146 29 0140	Brousek diamantovaný; 3,3 mm; 9,5 cm	Diamond instrument; 3,3 mm; 9,5 cm	245
146 29 0150	Brousek diamantovaný; 3,7 mm; 9,5 cm	Diamond instrument; 3,7 mm; 9,5 cm	245
146 29 0160	Brousek diamantovaný; 4,2 mm; 9,5 cm	Diamond instrument; 4,2 mm; 9,5 cm	245
146 29 0180	Brousek diamantovaný; 0,6 mm; 7,0 cm	Diamond instrument; 0,6 mm; 7,0 cm	245
146 29 1010	Brousek diamantovaný; 0,8 mm; 9,5 cm	Diamond instrument; 0,8 mm; 9,5 cm	245
146 29 1030	Brousek diamantovaný; 1,0 mm; 9,5 cm	Diamond instrument; 1,0 mm; 9,5 cm	245
146 29 1050	Brousek diamantovaný; 1,4 mm; 9,5 cm	Diamond instrument; 1,4 mm; 9,5 cm	245
146 29 1070	Brousek diamantovaný; 1,8 mm; 9,5 cm	Diamond instrument; 1,8 mm; 9,5 cm	245
146 29 1090	Brousek diamantovaný; 2,3 mm; 9,5 cm	Diamond instrument; 2,3 mm; 9,5 cm	245
146 29 1120	Brousek diamantovaný; 2,9 mm; 7,0 cm	Diamond instrument; 2,9 mm; 7,0 cm	245
146 29 1130	Brousek diamantovaný; 3,1 mm; 7,0 cm	Diamond instrument; 3,1 mm; 7,0 cm	245
146 29 1140	Brousek diamantovaný; 3,3 mm; 7,0 cm	Diamond instrument; 3,3 mm; 7,0 cm	245
146 29 1150	Brousek diamantovaný; 3,7 mm; 7,0 cm	Diamond instrument; 3,7 mm; 7,0 cm	245
146 29 1160	Brousek diamantovaný; 4,2 mm; 7,0 cm	Diamond instrument; 4,2 mm; 7,0 cm	245
146 29 1180	Brousek diamantovaný; 0,6 mm; 9,5 cm	Diamond instrument; 0,6 mm; 9,5 cm	245

A

Abraham nůž na mandle	43
Adson pinzeta anatomická	72
Adson pinzeta chirurgická	72
Agnew jehla paracentésní	29
Akumulátor do držadla	18
Anderson-Neivert dláto nosní	205
Aufricht (Walter) hák	130
Aufricht hák	130
Aufricht pilník nosní	193

B

Baby Metzenbaum nůžky micro super cut	61
Baby-Adson svorka na cévy	82
Baby-Crile-Wood jehelec	217
Backhaus svorka na prádlo	79
Baginsky nůž hrtanový	44
Ballenger dláto nosní	202
Ballenger nůž na nosní přepážku	36
Barany aparát zvukový	11
Barbara háček	30
Barbara jehla	30, 31
Barnhill kyreta na mandle	40
Baron (Schuknecht) odsávačka	231
Barth lžička nosní	175
Beckmann kyreta nosohltanová	39
Bellucci nůžky ušní	58
Berthold háček ušní jednozubý	127
Beyer štípek	96
Billeau smyčka drátěná	182
Blumenthal kleště štípací na kosti	90
Böhler kleště štípací na kosti	90
Bonney pinzeta chirurgická	73
Bose hák na průdušnici	133, 239
Bose rozvěrač	145, 239
Boucheron zrcátko ušní	154
Boynton jehelec oční	214
Bozemann jehelec hloubkový	218
Brousek diamantovaný	245
Bruenings držák jazyka	150
Bruenings kleště na nosní přepážku	100
Bruenings koncovka	105, 106
Bruenings lopatka na jazyk	149
Bruenings nůž na mandle	43
Bruenings nůž nosní	37
Bruenings otoskop	156
Bruenings skřípec na mandle	186
Bruenings zrcátko ušní	156
Bruenings žárovka s trubičkou pro otoskop	156
Buck kleště na cizí tělesa	112
Buck kyreta ušní	179
Buckingham nástroj ruční na ušní kůstku	235
Buchwald lopatka na jazyk	149

C

Caldwell-Luc hák na rány	132
Canfield nůž na mandle	43
Cinelli dláto	204
Citelli štípek	96
Clar 55 čelní lampa	24
Clar standard čelní lampa	24
Coakley kyreta nosní	184
Collin držátko skalpelových čepelek	27

Collin kleště na jazyk okénkové	120
Colver kleště na mandle	121
Converse dláto nosní	205
Converse hák	129
Converse nůž nosní	37
Converse pilník nosní	194
Cordes koncovka	106
Cottle (Millard) háček jemný	128
Cottle dláto nosní	203
Cottle háček jemný	128, 129
Cottle hák	129
Cottle kladívko	206
Cottle nůž nosní	37
Cottle nůžky	64
Cottle nůžky nosní	54
Cottle páčidlo nosní	164
Cottle pilník nosní	193, 196
Cottle-Neivert hák	129
Cottle-Walsham kleště na rovnání přepážky	118
Craig kleště na nosní přepážku	100
Craig-Domnick kleště na nosní přepážku	100
Crile jehelec	214, 216
Crile-Wood jehelec	217
Crura-Nipper kleště ušní	94

Č

Čepel náhradní k adenotomu	42
Čepel náhradní k noži nosnímu Bruenings	37
Čepel náhradní pro La Force	41
Čepelka skalpelová	28

D

Davis-Boyle lopatka	144
Davis-Boyle rozvěrač úst	144
Denhart rozvěrač úst	139
Derf jehelec tvrdokov	216
Desmarres držátko víček	126
Dieter kleště štípací mikro	95
Dingmann rozvěrač úst	143
Disk ochrany pro ušní stříkačku	236
Dláto na jemné kosti	201
Dláto na nosní plastiku	200
Dláto žlábkové nosní	201
Douglas nůž na mandle	43
Drátek	183
Drátek na mandle	188
Drátek pro skřípec na ušní polypy	181
Drátek pro výtěry	223
Držadlo bez regulace	228
Držadlo s baterií	18, 22
Držadlo s regulací	228
Držák jazyka	150
Držák jazyka pro Dingmann	143
Držák jazyka pro Kilner-Doughty	143
Držák kovový pro 12 ušních zrcátek	154
Držák kruhový	224
Držák patrový pro bezzubé	143
Držák rovný	224
Držák šikmý	224
Držátko skalpelových čepelek	27, 28, 239
Držátko zrcátek hrtanových	160
Duckbill kleště ušní	115
Durante pinzeta chirurgická	73

E

Elschnig pinzeta fixační	74
Eves skřípeč na mandle	186

F

Farrion zrcátko ušní	155
Faulkner kyreta nosní	184
Ferris-Smith pinzeta chirurgická	73
Finsen rozvěrač	139
Fisch disektor	221
Fischer nůž na mandle	43
Fomon háček jemný	128
Fomon nůž nosní	36
Fomon nůžky nosní	54
Fomon nůžky preparační	51
Fomon pilník nosní	194, 196
Foregger (Wisconsin) laryngoskop	16
Foregger laryngoskop	20
Foregger laryngoskopová lžice	16, 20
Fraenkel kleště na polypy	108, 116
Fraenkel koncovka	106
Freer dláto nosní	202
Freer háček jemný	128
Freer nůž na nosní přepážku	35
Freer páčidlo na nosní přepážku	166
Freer páčidlo nosní	164
Frenzel držák na jazyk	150
Fréza pro orl	209

G

Gallagher pilník nosní	193
Gerald pinzeta anatomická	72
Gil-Vernet hák páteří	126
Graefe pinzeta fixační	74
Gross smyčka drátěná	182
Gross-Maier kleště tamponové	111
Gruber zrcátko ušní	154
Gruenwald kleště štípací nosní	98

H

Háček na křídlo nosní	128
Háček na rány	125
Háček pro plastiku	125, 129
Hajek kladívko	206
Hajek-Claus štípací	102
Hajek-Kofler štípací	101
Hák jemný	125, 126
Hák na choanální polypy	130
Hák resekcí	131
Hák tracheální	133
Halle lžička nosní	175
Halle nůž na nosní plastiku	37
Halle páčidlo nosní	166
Halsey jehelec	217
Halsted-Mosquito svorka na cévy	81
Hartmann držák na jazyk	149
Hartmann háček ušní	127
Hartmann katetr ušní	231
Hartmann kleště na polypy	116, 117
Hartmann kleště na ušní polypy	92
Hartmann kleště štípací nosní	98
Hartmann kleště ušní štípací	91
Hartmann ladička	12, 13
Hartmann škrabka ušní	171
Hartmann štípací na mandle	103
Hartmann zrcátko nosní	157, 158
Hartmann zrcátko ušní	153
Hartmann-French ladička	12

Hartmann-Halle zrcátko nosní	158
Hartmann-Noyes kleště ušní	115
Hartmann-Wullstein kleště	116
Hartmann-Wullstein kleště na polypy	116
Haslinger hák na mandle	135
Heath nůžky pro ligaturu	56
Heermann držadlo	235
Heiss svorka na cévy	83
Heister rozvěrač úst	139
Henke páčidlo na mandle	167
Heymann kleště na nosní přepážku	100
Heymann nůž na nosní plastiku	37
Heymann nůžky nosní	53
Heymann-Knight kleště nosní na polypy	117
Hlava sací se zvětšováním	156
Hofer enucleator	135
Holbroock-Curtis pilka nosní	191
Hough nůžky nosní	54
House kyreta ušní	180
House odsávačka	231
House pátradlo měřící	221
Howarth páčidlo nosní	165
Huber univerzální držadlo	105
Hurd škrabka na mandle	172
Hurd škrabka nosní	172

CH

Chevalier-Jackson kanyla tracheální	232
Chevalier-Jackson kleště hrtanové	104

I

Iris nůžky micro super cut	62
Irterson hák na průdušnici	133, 239

J

Jabaley-Stille nůžky micro super cut	59
Jackson hák na průdušnici	134
Janet stříkačka	237
Jansen kleště ušní	93
Jansen lžička nosní	175
Jansen rozvěrač	139
Jansen-Middleton kleště štípací	99
Jehelec hloubkový	215, 216
Jehelec jemný	216
Jehelec pro plastiku	214
Jehla	31
Jehla punkční	227
Jennings rozvěrač úst	141
Joseph hák jemný	125
Joseph nůž na nosní plastiku	37
Joseph nůž nosní	36, 38
Joseph páčidlo nosní	166
Joseph pilník nosní	191, 192
Joseph-Masing páčidlo nosní	166
Jurasz kleště na polypy	108

K

Kabierske kanyla	14
Kabierske náhradní láhev	14
Kabierske zaprašovač	14
Kabierske žárovka ventilová	14
Kanyla laryngeální	229
Kanyla osazená lomená	229
Kanyla pro ušní stříkačku	236
Kanyla s olivkou lomená	229
Kanyla s olivkou rovná	229
Kanyla sací	231

Kanyla tracheální	232
Kerrison štípek	101, 102
Kilian kleště nosní na polypy	117
Killian nůžky na septum	57
Killian páčidlo nosní	165
Killian zrcátko nosní	157
Killian-Claus dláto nosní	202
Kilner háček jemný	128
Kilner jehelec	217
Kilner nůžky preparační	52
Kilner-Doughty rozvěrač úst	143
Kladívko	206
Kladívko chirurgické	206
Kleinert-Kutz kleště štípací na kosti	90
Kleště mikro laryngeální	120
Kleště mikro miskové	107
Kleště mikro miskové rovné	107
Kleště na bronchoskopii	107
Kleště na nosní skořepu	119
Kleště štípací	93
Kleště tamponové	111
Kleště úchopné	93
Kleště ušní	113
Kleště ušní mikro	94
Kleště ušní úchopné	113, 114
Klíček utahovací k držákům skalpelových čepelek	28
Knight kleště na nosní přepážku	100
Kocher pátradlo na strumu	223
Kocher svorka na cévy jemná	85
Koncovky gumové pro kleště Young	120
Koncovky kovové	206
Krause koncovka	106
Krause skřípec na ušní polypy	181
Krause štípek nosní	183
Krause-Voss skřípec na ušní polypy	181
Krause-Voss štípek nosní	183
Kressner kleště na přepážku	119
Kroenig držák jazyka	150

L

La Force adenotom	41
La Force čepel adenotomu	41
La Grange nůžky micro super cut	62
Laborde rozvěrač	145
Ladička hliníková	12, 13
Lahey kleště úchopné	112
Lampa čelní	23, 24
Lane pinzeta chirurgická	71
Lange háček jemný	128
Lange kleště na polypy	108
Lange koncovka	106
Lange-Wilde skřípec na ušní polypy	181
Lange-Wilde štípek nosní	183
Langenbeck chránič prstu	238
Langenbeck kyreta ušní	179
Langenbeck páčidlo	166
Larkin nástroj ruční na ušní kůstku	235
Lempert kyreta	180
Lempert páčka ušní	163
Lempert škrabka	171
Lewis pilník nosní	193
Lewis pilník nosní tvrdokovový	196
Lexer nůžky	64
Lexer nůžky preparační	52
Lexer-Baby nůžky preparační	51
Lister (bandage) nůžky micro super cut	59
Littauer nůžky pro ligaturu	56
Löbker kleště na jazyk	120
Lopatka na jazyk	150
Lopez-Reinke páčidlo na mandle	167
Love hák na mandle	135

Lubet-Barbon kleště nosní na polypy	117
Luc kleště	100
Lucae jehla paracentésní	29
Lucae ladička	12
Lucae páčka ušní	163
Lucae pátradlo háčkové	221
Lucae pinzeta ušní	75
Ludewig háček na kovadlinku	127
Luer hák na průdušnici	134
Luer kanyla tracheální	232, 239
Luer kleště štípací na kosti	89
Lukens hák na průdušnici	133
Luniatschek zavadeč drenů	213
Lžička ostrá oválná	176
Lžička ostrá trepanační	176

M

Maltz nůž nosní	38
Maltz pilník nosní	193
Maršík pinzeta na mandle	75
Masing dláto nosní	205
Masing hák	129
Masing nůž nosní	37
Masing páčidlo nosní	165
Masing pilník nosní	194
Mastin svorka na svaly	86
Mathieu jehelec	217
Maunder závaží do úst	238
Mayo držák jazyka	150
Mayo nůžky	63
Mayo nůžky preparační	50
Mayo-Harrington nůžky micro super cut	60
Mayo-Stille nůžky	63
Mayo-Stille nůžky micro super cut	60
Mayo-Stille nůžky preparační	50
MC Ivor lopatka	142
MC Ivor rám	142
MC Ivor rozvěrač úst	142
McGee háček	31
McGee kleště ušní	94
McIntosh laryngoskop	15, 19
McIntosh laryngoskopová lžice	15, 19
McKenty páčidlo nosní	164, 166
Meeker svorka na cévy	83
Metzenbaum nůžky	64, 65
Metzenbaum nůžky micro super cut	61
Metzenbaum nůžky preparační	49
Metzenbaum-Delicate nůžky	66
Metzenbaum-Delicate nůžky preparační	49
Metzenbaum-Nelson nůžky preparační	49
Micro-Adson pinzeta anatomická	72
Micro-Adson pinzeta chirurgická	72
Micro-Mosquito svorka na cévy	81
Middeldorpf hák na rány	132
Miller laryngoskop komplet	17, 21
Miller laryngoskopová lžice	17, 21
Miller-Colburn pilník nosní	195
Miska	240
Mod. Wien zrcátko nosní	158
Mod. Würzburg držák jazyka	144
Molt rozvěrač úst	139
Moritz-Schmidt držák jazyka	149
Mosquito-Halsted svorka na cévy	80
Museux kleště úchopné	121
Myles kleště štípací nosní	98

N

Nager hák na mandle	135
Náhradní žárovka	23
Nástroj ruční na ušní kůstku	235

Negus podpora pro rozvěrač úst	145
Neivert dláto nosní	205
News hák na průdušnici	134
Northbent nůžky pro ligaturu	56
Nůž na flegmonu	44
Nůž na furunkl s kyvetou	35
Nůžky chirurgické	47, 48
Nůžky mikro	57
Nůžky oční	55, 56
Nůžky preparační	50, 51, 52, 53
Nůžky preparační dětské	52

O

Odsávačka lomená	229
Odsávačka lomená mikro	228
Odsávačka oblouková mikro	228
Odsávačka s regulací a olivkou	230
Odsávačka silně zahnutá mikro	228
Odsávačka zahnutá s olivkou	229
Ochsner-Kocher svorka na cévy	79
Olsen-Hegar jehelec/nůžky	215, 218
Overholt svorka na lobektomii	86
Overholt-Geissendoerfer svorka na cévy	82

P

Páčka ušní	163
Pátradlo nosní	222
Pátradlo paličkové	221, 222
Pátradlo paličkové s dlátkem	221
Pátradlo ušní	222
Pean svorka na cévy	79, 239
Pean svorka na cévy jemná	85
Pennington páčidlo nosní	165
Pierce páčidlo nosní	165
Pinzeta anatomická	69, 75, 239
Pinzeta bipolární	76
Pinzeta chirurgická	70, 71, 239
Pinzeta na plastiku šicí	71
Pinzeta na rohovku	74
Pítha závaží do úst	238
Plester aplikátor	171
Plester nůž ušní	32
Politzer jehla paracentézní	29
Politzer nůž na furunkl	35
Politzer sáček vzduchový	14
Politzer špička	14
Politzer zrcátko ušní	153
Politzer žárovka	14
Potts-Smith pinzeta anatomická	72
Potts-Smith pinzeta chirurgická	72
Prince nůžky na mandle	53
Přečechtěl škrabka nosní	172
Přehrádka sterilizační	241
Přechodka Luer	229

Q

Quire kleště na cizí tělesa	112
-----------------------------	-----

R

Rám pro rozvěrač Kilner-Doughty	143
Rám pro rozvěrač úst Davis-Boyle	144
Rám pro rozvěrač úst Kilner-Doughty	143
Reichert hák na epiglottis	134
Reynolds nůžky preparační	53
Richnau Holmgren zrcátko ušní	156
Röder skřípec na mandle	188
Rochester-Pean svorka na cévy	84

Rose hák na průdušnici	134
Rosen jehla	30, 31
Rosen nůž ušní	32
Rosen škrabka	171
Rosenberg koncovka	106
Roser-König rozvěrač úst	139
Rozvěrač ran	140
Rubin dláto	204
Rubin kleště na rovnání přepážky	118
Ryder/French-Eye jehelec	217

S

Sada 5 ladiček hliníkových	13
Sada logopedických nástrojů	224
Sanvenero nůžky preparační	53
Seemann-Seiffert rozvěrač úst	142
Seiffert koncovka	106
Senn-Miller hák páteřní	126
Set pro tracheotomii	239
Sewall kyreta nosní ostrá	184
Shambaugh jehla	30
Shambaugh-Derlacki páčka ušní	163
Shapleigh kyreta ušní	179
Shea kyreta ušní	180
Sheehan dláto	204
Scheinmann koncovka	106
Schmeden kleště štípací nosní	98
Schmeden štípací na mandle	103
Schmidt-Sawtell svorka na cévy	83
Schuknecht nůž ušní	32
Schumacher koncovka	106
Schwartz háček ušní	127
Schwartz jehla paracentézní	29
Schwartz tenotom ušní	33
Siegler otoskop komplet	156
Siegler zrcátko ušní	156
Silver dláto nosní	205
Simplex držák na tváře	149
Sluder-Ballenger držadlo	185
Sluder-Ballenger koncovka	185
Sluder-Ballenger tonsillektom	185
Smyčka drátěná	181, 183, 187
Snellen smyčka drátěná	182
Sonda žlábková	239
Součástka pro ušní stříkačku	236
Spencer nůžky pro ligaturu	56
Sprague háček ušní	34
Sprague jehla paracentézní	34
Sprague lžička ušní	34
Sprague nůž	34
Sprague operační set	34
Sprague pátradlo	34
Sprague smyčka ušní	34
St.Clair-Thompson kyreta na mandle	40
Stacke dláto ušní žlábkové	199
Stacke chránič dlátek	199
Stacke nůž na zvukovod	33
Standard držák jazyka	150
Standard pinzeta anatomická	69
Stellbrink kleště štípací na kosti	90
Sternberg rozvěrač úst dvojité	145
Stevens nůžky micro super cut	59
Stevens nůžky oční	54
Stille nůžky micro super cut	59
Stille-Barraya pinzeta chirurgická	73
Stille-Mayo nůžky micro super cut	60
Stille-Rangell nůžky micro super cut	60
Strümpel kleště na ušní polypy	92
Strümpel kleště ušní štípací	91
Struycken kleště štípací nosní	98

A

Abraham tonsil knife	43
Accumulator insert for battery handle	18
Adenotom blade	42
Adson dressing forceps	72
Adson tissue forceps	72
Agnew paracentesis needle	29
Anatomical forceps	75
Anderson-Neivert chisel	205
Angled holder	224
Asch septum straightening forceps	118
Aufricht (Walter) hook	130
Aufricht hook	130
Aufricht nasal rasp	193
Aural probe	222

B

Baby Metzenbaum scissors micro super cut	61
Baby-Adson artery forceps	82
Baby-Crile-Wood needle holder	217
Backhaus towel forceps	79
Baginsky laryngeal knife	44
Ballenger knife for septum	36
Ballenger nasal chisel	202
Ballenger septum swivel knife	36
Barany sound apparatus	11
Barbara hooklet	30
Barbara needle	30, 31
Barnhill adenoid curette	40
Baron (Schuknecht) suction tube	231
Barth nasal spoon	175
Battery handle	18
Beckmann adenoid curette	39
Bellucci scissors	58
Berthold ear hook	127
Beyer punch	96
Billeau loop	182
Bipolar forceps	76
Bipolar forceps bay-shaped	76
Blades	28
Blumenthal bone ronguers	90
Böhler bone ronguers	90
Bonney tissue forceps	73
Bose dilators	145, 239
Bose trachea retractor left	133, 239
Boucheron ear specula	154
Bowl	240
Boynton eye needle holder	214
Bronchoscopy forceps	107
Bruenings ear specula	156
Bruenings knife	37
Bruenings otoscope	156
Bruenings rubber bulb only for otoscope	156
Bruenings septum forceps	100
Bruenings tip	105, 106
Bruenings tongue spatula	149
Bruenings tonsil knife	43
Bruenings tonsil snare	186
Bruenings tongue depressor	150
Buck ear curette	179
Buck ear forceps	112
Buckingham footplate hand instrument	235
Buchwald tongue spatula	149
Bulb halogen 2,5 V	22

Bulb krypton 2,5 V	22
--------------------	----

C

Caldwell-Luc retractor	132
Canfield tonsil knife	43
Cannula for ear syringe	236
Chevalier-Jackson laryngeal forceps	104
Chevalier-Jackson trachea tube	232
Choanal hook	130
Cinelli osteotome	204
Citelli punch	96
Clar 55 head lamp 6 volt	24
Clar head lamp	24
Coakley nasal curette	184
Collin scalpel handle	27
Collin tongue holding forceps	120
Colver tonsil forceps	121
Connecting piece	229
Converse hook	129
Converse chisel	205
Converse nasal knife	37
Converse nasal rasp	194
Cordes tip	106
Corneal suturing forceps	74
Cottle (Millard) delicate hook	128
Cottle delicate hook	128
Cottle hook	129
Cottle chisel	203
Cottle knife	37
Cottle mallet	206
Cottle nasal elevator	164
Cottle nasal rasp	193, 196
Cottle nasal scissors	54
Cottle osteotome	203
Cottle scissors	64
Cottle-Neivert hook	129
Cottle-Walsham septum straightening forceps	118
Craig septum forceps	100
Craig-Domnick septum forceps	100
Crile needle holder	214, 216
Crile-Wood needle holder	217
Crura-Nipper micro ear forceps	94

D

Davis-Boyle mouth gag	144
Davis-Boyle tongue depressor	144
Delicate hook	125
Denhart mouth retractor	139
Depilation needle	37
Derf needle holder	216
Desmarres delicatehook	126
Desmarres retractor	126
Diamond instrument	245
Dieter micro ear forceps	95
Dingmann mouth retractor complete	143
Dissecting scissors	50, 51, 52, 53
Douglas tonsil instrument	43
Dressing forceps	69
Duckbill ear forceps	115
Durante tissue forceps	73

E

Ear elevator	163
Ear forceps	113, 114
Ear instrument complete	236
Ear syringe complete	236
Element for ear syringe	236
Elschnig fixatin forceps	74
Endolaryngeal micro scissors	57
Ent bur	209
Eves tonsil snare	186
Eye scissors	55, 56

F

Farrior ear specula	155
Ferris-Smith tissue forceps	73
Ferrozell faces	206
Finsen retractor	139
Fisch dissector	221
Fischer tonsil knife	43
Fomon delicate hook	128
Fomon dissecting scissors	51
Fomon knife	36
Fomon nasal rasp	194, 196
Fomon nasal scissors	54
Footplate hand instrument	235
Forceps micro	107
Foregger (Wisconsin) laryngoscope	16
Foregger blade	16
Foregger fibre optic blade	20
Foregger fibre optic laryngoscope	20
Fraenkel polypus forceps	108, 116
Fraenkel tip	106
Frame for Kilner-Doughty retractor	143
Freer delicate hook	128
Freer nasal elevator	164
Freer nasal chisel	202
Freer septum elevator	166
Freer septum knife	35
Frenzel tongue depressor	150
Furuncle knife with curette	35

G

Gag only for Davis-Boyle	144
Gag only for Kilner-Doughty mouth gag	143
Gallagher nasal rasp	193
Gerald dressing forceps	72
Gil-Vernet spinalhook	126
Gouge for fine bones	201
Graefe fixation forceps	74
Grasping forceps	93
Grooved director	239
Gross loop	182
Gross-Maier sponge holding forceps	111
Gruber ear specula	154
Gruenwald nasal cutting forceps	98

H

Hajek mallet	206
Hajek-Claus sphenoid punch	102
Hajek-Kofler sphenoid punch	101
Halle nasal elevator	166
Halle nasal plastic knife	37
Halle nasal spoon	175
Halsey needle holder	217
Halsted-Mosquito artery forceps	81
Handle fibre optic battery	22
Handle for laryngeal mirrors	160
Handle with regulation	228

Handle without regulation	228
Hartman ear raspatory	171
Hartmann ear catheter	231
Hartmann ear forceps	91
Hartmann ear hook	127
Hartmann ear polypus forceps	92
Hartmann ear specula	153
Hartmann for children set	153
Hartmann nasal cutting forceps	98
Hartmann nasal polypus forceps	116, 117
Hartmann nasal specula	157, 158
Hartmann polypus forceps	116
Hartmann tongue depressor	149
Hartmann tonsil punch	103
Hartmann tuning fork	12, 13
Hartmann-French tuning fork	12, 13
Hartmann-Halle nasal specula	158
Hartmann-Noyes ear forceps	115
Hartmann-Wullstein polypus forceps	116
Haslinger tonsil hook	135
Head light 220 V	23
Head mirror with cover	23
Heath ligature scissors	56
Heermann handle	235
Heiss artery forceps	83
Heister mouth retractor	139
Henke dissector	167
Heymann nasal plastic knife	37
Heymann nasal scissors	53
Heymann septum forceps	100
Heymann-Knight nasal polypus forceps	117
Hofer enucleator	135
Holbrook-Curtis nasal saw	191
Hough nasal scissors angled	54
House ear curette	180
House measuring probe	221
House suction tube	231
Howarth nasal elevator	165
Huber universal handle	105
Hurd nasal raspatory	172
Hurd tonsil raspatory	172

I

Iris scissors micro super cut	62
Irterson trachea retractor	133, 239
Jabaley-Stille scissors micro super cut	59
Jackson trachea hook	134
Janet syringe	237
Jansen mastoid forceps	93
Jansen nasal spoon	175
Jansen retractor	139
Jansen-Middleton nasal cutting forceps	99
Jennings mouth retractor	141
Joseph delicate hook	125
Joseph knife	36, 38
Joseph nasal elevator	166
Joseph nasal plastic knife	37
Joseph nasal rasp	191
Joseph nasal saw	192
Joseph-Masing nasal elevator	166
Jurasz polypus forceps	108

K

Kabierske cannula	14
Kabierske powder blower	14
Kabierske spare bottle	14
Kabierske valve rubber bulb	14
Kerrison punch	102
Kerrison sphenoid punch	101
Kilian nasal polypus forceps	117

Killian nasal elevator	165	Maltz nasal rasp	193
Killian nasal specula	157	Maršik tonsil forceps	75
Killian septum scissors	57	Masing hook	129
Killian-Claus nasal chisel	202	Masing chisels	205
Kilner delicate hook	128	Masing knife	37
Kilner dissecting scissors	52	Masing nasal elevator	165
Kilner needle holder	217	Masing nasal rasp	194
Kilner-Doughty mouth retractor complete	143	Masing osteotome	205
Kleinert-Kutz bone ronguers	90	Mastin muscular clamp	86
Knight septum forceps	100	Mastoid forceps	93
Kocher artery forceps fine	85	Mathieu needle holder	217
Kocher goitre probe	223	Maunder oral wedge	238
Krause nasal snare	183	Mayo dissecting scissors	50, 63
Krause polypus snare	181	Mayo tongue depressor	150
Krause tip	106	Mayo-Harrington scissors micro super cut	60
Krause-Voss nasal snare	183	Mayo-Stillie dissecting scissors	50
Krause-Voss polypus snare	181	Mayo-Stillie scissors micro super cut	60
Kressner septum forceps	119	Mayo-Stillie scissors tuc	63
Kroenig tongue depressor	150	MC Ivor blade	142
		MC Ivor frame	142
		MC Ivor mouth retractor	142
		McGee hooklet	31
		McGee micro ear forceps	94
		McIntosh blade	15
		McIntosh fibre optic blade	19
		McIntosh fibre optic laryngoscope	19
		McIntosh laryngoscope	15
		McKenty nasal elevator	164, 166
		Meeker artery forceps	83
		Metal support for 12 ear speculas	154
		Metzenbaum dissecting scissors	49
		Metzenbaum scissors micro super cut	61
		Metzenbaum scissors tuc	64, 65
		Metzenbaum-Delicate scissors	49, 66
		Metzenbaum-Nelson dissecting scissors	49
		Metzenbaum-Nelson scissors	49
		Micro ear forceps	94
		Micro-Adson dressing forceps	72
		Micro-Adson tissue forceps	72
		Micro-Mosquito artery forceps	81
		Middeldorpf retractor	132
		Miller blade	17
		Miller fibre optic blade	21
		Miller fibre optic laryngoscope	21
		Miller laryngoscope	17
		Miller-Colburn nasal rasp	195
		Mod. Wien nasal specula	158
		Mod. Würzburg tongue depressor	144
		Molt mouth retractor for adults	139
		Molt mouth retractor for children	139
		Moritz-Schmidt tongue depressor	149
		Mosquito-Halsted artery forceps	80
		Museux grasping forceps	121
		Myles nasal cutting forceps	98

L

La Force adenotom	41
La Force spare blade	41
La Grange scissors micro super cut	62
Laborde dilators	145
Lahey ear forceps	112
Lane tissue forceps	71
Lange delicate hook	128
Lange polypus forceps	108
Lange tip	106
Lange-Wilde nasal snare	183
Lange-Wilde polypus snare	181
Langenbeck ear curette	179
Langenbeck elevator	166
Langenbeck finger protector	238
Larkin footplate hand instrument	235
Laryngeal cannula	229
Laryngeal micro forceps	120
Laryngeal mirror	160
Laryngoscope bulb	18
Lempert curette	180
Lempert ear elevator	163
Lempert raspatory	171
Lewis nasal rasp	193, 196
Lexer dissecting scissors	52
Lexer scissors	64
Lexer-Baby dissecting scissors	51
Lister (bandage) scissors micro super cut bent	59
Littauer ligature scissors	56
Löbker tongue holding forceps	120
Lopez-Reinke dissector	167
Love tonsil hook	135
Lubet-Barbon nasal polypus forceps	117
Luc septum forceps	100
Lucae ear anatomical forceps	75
Lucae ear elevator	163
Lucae hooklet	221
Lucae paracentesis needle	29
Lucae tuning fork	12
Ludewig incus hook	127
Luer bone rongeurs	89
Luer trachea hook	134
Luer trachea tube	232, 239
Lukens trachea hook	133
Luniatschek drain introducer	213

M

Mallet	206
Mallet metallic	206
Maltz knife malleable	38

N

Nager tonsil hook	135
Nasal alar hook	128
Nasal gouge	201
Nasal plastic chisel	200
Nasal probe	222
Nasal septum forceps	119
Needle downwards	31
Needle holder	215, 216, 218
Needle holder for plastic surgery	214
Needle upwards	31
Negus chest support for mouth gag	145
Neivert chisel	205
News trachea hook	134
Northbent ligature scissors	56

O

Ochsner-Kocher artery forceps	79
Olsen-Hegar needle holder/scissors	215, 218
Overholt lobectomy forceps	86
Overholt-Geissendoerfer forceps	82

P

Palatal support for toothless	143
Pean artery forceps	79, 239
Pean artery forceps fine	85
Pennington nasal elevator	165
Phegmon knife	44
Pierce nasal elevator	165
Pitha oral wedge	238
Plastic hook	125
Plester application instrument	171
Plester knife	32
Politzer air bag	14
Politzer bulb	14
Politzer ear specula	153
Politzer furuncle knife	35
Politzer paracentesis needle	29
Politzer point	14
Potts-Smith dressing forceps	72
Potts-Smith tissue forceps	72
Prince tonsil scissors	53
Probe	222
Probe olive	221
Probe olive with chisel	221
Protecting disk for ear syringe	236
Přecechtěl nasal raspatory	172
Puncture needle	227

Q

Quire ear forceps	112
-------------------	-----

R

Rasp eschewed	191
Reichert epiglottis retractor	134
Resection hook	131
Retractor	140
Retractor sharp	125
Retractor sharp flexible	126
Reynolds dissecting scissors	53
Richnau Holmgren ear specula	156
Röder tonsil snare	188
Rochester-Pean artery forceps	84
Rose trachea hook	134
Rosen knife	32
Rosen needle	30, 31
Rosen raspatory	171
Rosenberg tip	106
Roser-König mouth retractor	139
Round curved holder	224
Rubber only for forceps Young	120
Rubbertube and bulb only for siegle specula	156
Rubin osteotome	204
Rubin septum straightening forceps	118
Ryder/French-Eye needle holder	217

S

Sanvenero dissecting scissors	53
Scalpel handle	27, 28, 239
Seemann-Seiffert mouth retractor	142
Seiffert tip	106
Senn-Miller spinalhook	126
Set of 5 tuning forks aluminium	13

Set of Hartmann tuning forks	13
Set of instruments for logopaedia	224
Sewall nasal curette sharp	184
Shambaugh needle	30
Shambaugh-Derlacki ear elevator	163
Shapleigh ear curette	179
Shea ear curette	180
Sheehan osteotome	204
Scheinmann grid tip	106
Scheinmann tip	106
Schmeden nasal cutting forceps	98
Schmeden tonsil punch	103
Schmidt-Sawtell artery forceps	83
Schuknecht knife	32
Schumacher tip	106
Schwartz ear hook	127
Schwartz paracentesis needle	29
Schwartz tenotomy knife	33
Siegle ear specula	156
Siegle otoscope complete	156
Silver chisel	205
Simplex cheek retractor	149
Sluder-Ballenger handle only	185
Sluder-Ballenger tip	185
Sluder-Ballenger tonsillectome	185
Snellen loop	182
Spanner for scalpel blade holder	28
Spare blade for 112 91 0264	37
Spare blade for La Force	41
Spare lamp	23
Speaking tube	232
Spencer ligature scissors	56
Sponge holding forceps	111
Spoon sharp	176
Sprague ear hooklet	34
Sprague ear loop	34
Sprague ear operating set	34
Sprague ear spoon	34
Sprague knife	34
Sprague paracentesis needle	34
Sprague probe	34
St.Clair-Thompson adenoid curette	40
Stacke ear gouge	199
Stacke chisel guide	199
Stacke sounds knife	33
Standard dressing forceps	69, 239
Standard operating scissors	47, 48
Standard tissue forceps	70, 239
Standard tongue depressor	150
Stellbrink bone ronguers	90
Sterilization stand	241
Sternberg lip retractor double	145
Stevens scissors micro super cut	59
Stevens tenotomy scissors	54
Stille scissors micro super cut	59
Stille-Barraya tissue forceps	73
Stille-Mayo scissors micro super cut	60
Stille-Rangell scissors micro super cut	60
Straight holder	224
Strümpel ear forceps	91
Strümpel ear polypus forceps	92
Struycken nasal cutting forceps	98
Suction cannula	231
Suction head with magnification	156
Suction tube	228, 229
Suction tube with olive	229
Suction tube with regulation and olive	229, 230
Suturing forceps	71
Swab wire	223
Syringe	237

T	
Tabb knife	32
Takahashi nasal cutting forceps straight	99
Thorek dissecting scissors	51
Thudichum nasal specula	159
Tieck-Halle nasal specula	158
Tissue forceps	70, 71
Tobold tongue depressor hollow	149
Tongue depressor	150
Tongue depressor for Dingmann	143
Tongue depressor for Kilner-Doughty	143
Tongue spatula	150
Toynbee ear specula	153
Tracheal hook	133
Tracheotomy set	239
Troeltsch ear forceps	75
Troeltsch nasal forceps	75
Troeltsch sound hook	127
Tuning fork aluminium	12, 13
Tyding tonsil snare	188

U	
Uckermann trocar	227
Univ. Minnesota tongue depressor	150





















V	
Voltolini (Duplay) nasal specula	159
Voltolini nasal specula	159

W	
Wagener ear hook	127
Walsham septum straightening forceps	118
Walter chisels	204
Walter osteotome	204
Weil-Blakesley nasal cutting forceps	97
Weingärtner ear forceps	115
Weitlaner retractor	140
West nasal chisel	201, 202
Westmacott nasal polypus forceps	117
White tonsil forceps	121
Whitehead mouth retractor	141
Wieder tongue depressor	149
Wiener nasal rasp	194
Williger elevator	166
Williger mallet metallic	206
Williger raspatory	172
Wire	183
Wire for polypus snare	181
Wire for tonsil	188
Wire loop	181, 183
Wire loop for tonsil	187
Wullstein ear forceps	115
Wullstein ear-scissors	58
Wullstein handle	231
Wullstein knife	32
Wullstein micro ear forceps	95
Wullstein raspatory	171
Wullstein tube connection piece	231

Y	
Yankauer nasal needle	213
Young tongue forceps	120

Z	
Zaufal ear hook	127

Zöllner ear specula	154
Zöllner suction tube	231

	použit do	use by
	datum výroby	date of manufacture
	výrobce	manufacturer
	nepoužívat znovu	do not reuse
	neprovádět opětovnou sterilizaci	do not resterilize
	nepoužívat, jestliže je balení poškozeno	do not use if package is damaged
	otevřené balení nebude nahrazeno	opened packages are not replaced
	set, souprava	assortment
	pozor sledujte průvodní dokumentaci	caution, consult accompanying documents
	nesterilní	non sterile
	kód dávky	batch code
	katalogové číslo	catalogue number
	množství	quantity
	kontrola	control
	sterilní	sterile
	sterilizace ozářením	sterilization using irradiation
	sterilizace ethylenoxidem	sterilization using ethylene oxide
	sterilní zdravotnické prostředky zpracované aseptickou technologií	sterile by aseptic techniques
	diagnostický zdravotnický prostředek in vitro	in vitro diagnostic medical device
	globální nomenklatura zdravotnických prostředků	global medical device nomenclature code
	sledujte návod k použití	consult instructions for use

- ▶ CHIRURGIE / SURGERY
- ▶ TRAUMATOLOGIE / TRAUMATOLOGY
- ▶ ORTOPEDIE / ORTHOPAEDICS
- ▶ STOMATOLOGIE / DENTISTRY
- ▶ STERILIZACE / STERILIZATION
- ▶ LAPAROSKOPIE / LAPAROSCOPY
- ▶ ENDOSKOPIE / ENDOSCOPY
- ▶ ARTROSKOPIE / ARTHROSCOPY



kompletní nabídka lékařských nástrojů a implantátů na
full range of medical instruments and implants on

▶ www.medin.cz

© 2009 MEDIN, a.s.; Všechna práva vyhrazena.

Dokument je určen pro obchodní účely MEDIN, a.s., údaje zde uvedené jsou informativního charakteru.

Žádná část tohoto dokumentu nesmí být reprodukována nebo publikována v jakékoliv formě bez předchozího souhlasu MEDIN, a.s.

Zobrazení produktů odpovídá aktuálnímu stavu v době vydání tohoto dokumentu. Změny technických parametrů z důvodu dalšího vývoje jsou vyhrazeny.

Tiskové a typografické chyby jsou vyhrazeny.

© 2009 MEDIN, a.s.; All rights reserved.

This document should be used for commercial purposes of MEDIN, a.s.; the data mentioned in the document has informative character.

No part of this document can be copied or published in any form without approval of MEDIN, a.s.

The product design may differ from those depicted in these illustrations at the date of issue. Adjustments, made from the reason of further developments of technical parameters, are reserved.

Printing and typographical errors are reserved.

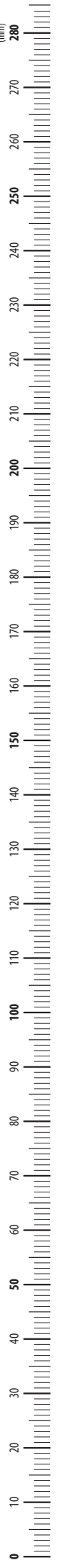

MEDIN, a.s.

Vlachovická 619
Nové Město na Moravě
CZ 592 31
Czech Republic
IČO 43378030
DIČ CZ43378030

CENTRÁLA

tel.: 566 684 111

PRODEJ ČESKÁ REPUBLIKA

tel.: 566 684 327-8
fax: 566 684 384
e-mail: prodej@medin.cz

PRODEJNA PRAHA

Jana Želivského 6
Praha 3
CZ 130 00
tel./fax: 222 592 334
mobil: 606 686 530

PRODEJ SLOVENSKÁ REPUBLIKA

tel.: +420 566 684 332
fax: +420 566 684 385
e-mail: export@medin.cz

EXPORT

phone: +420 566 684 336
fax: +420 566 684 385
e-mail: export@medin.cz

www.medin.cz

**NÁSTROJE PRO ORL
INSTRUMENTS FOR ENT**

2009

