

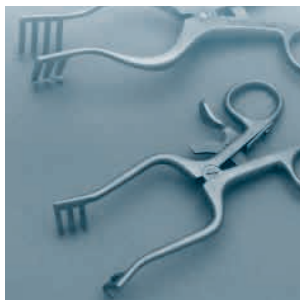

NÁSTROJE PRO CHIRURGII
INSTRUMENTS FOR SURGERY

C H I R U R G I E – S U R G E R Y

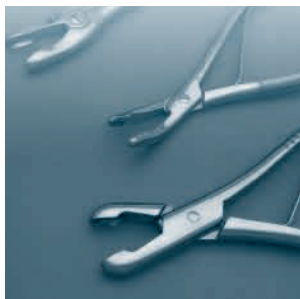

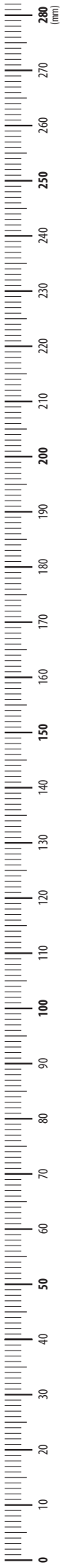

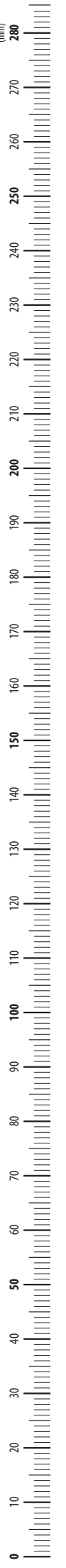

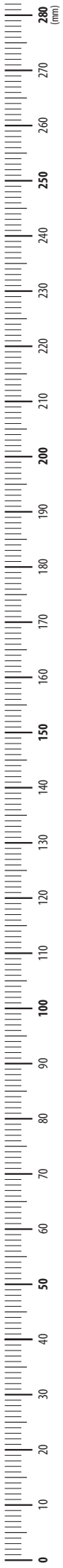

MEDIN, a.s.

Vlachovická 619
Nové Město na Moravě
CZ 592 31
Czech Republic
IČO 43378030
DIČ CZ43378030

CENTRÁLA

tel.: 566 684 111

PRODEJ ČESKÁ REPUBLIKA

tel.: 566 684 327
fax: 566 684 384
e-mail: prodej@medin.cz

PRODEJNA PRAHA

Jana Želivského 6
Praha 3
CZ 130 00
tel./fax: 222 592 334
mobil: 606 686 530

PRODEJ SLOVENSKÁ REPUBLIKA

tel.: +420 566 684 332
fax: +420 566 684 385
e-mail: export@medin.cz

EXPORT

phone: +420 566 684 336
fax: +420 566 684 385
e-mail: export@medin.cz

www.medin.cz





Certifikát EN ISO 13485
Certificate EN ISO 13485

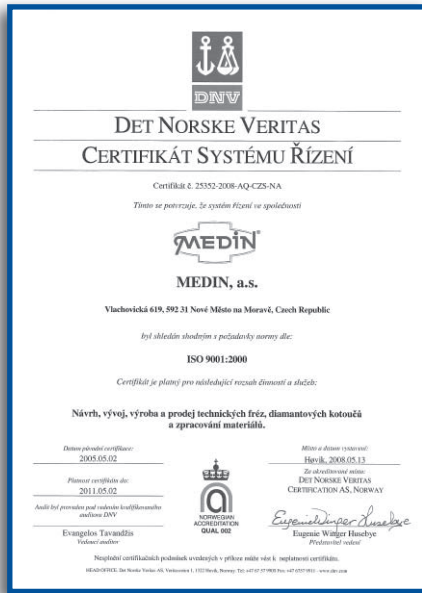

Certifikát ISO 9001
Certificate ISO 9001



Certifikát ISO 14001
Certificate ISO 14001

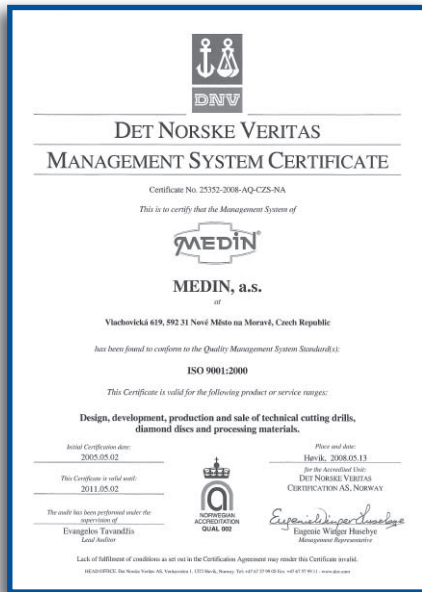
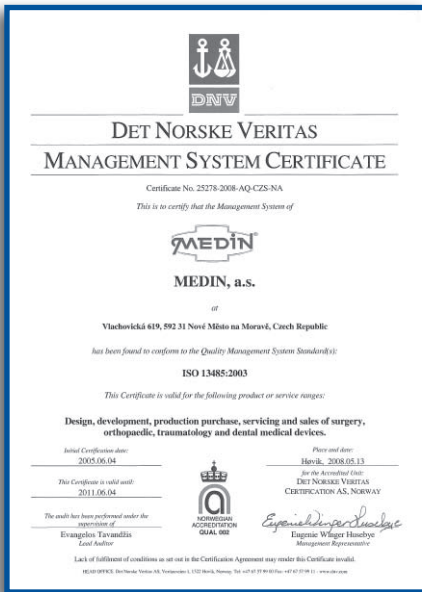

CE 0434

Akciová společnost MEDIN se sídlem v Nové Městě na Moravě zahájila činnost 4. 5. 1992 jako právní nástupce bývalého státního podniku Chirana Nové Město na Moravě.

MEDIN, a.s., je největší český výrobce nástrojů pro humánní lékařství ve všech hlavních oborech lékařských specializací včetně kostní chirurgie a implantátů pro traumatologii a ortopedii. Zároveň je největším českým výrobcem dentálních nástrojů jak ordinálních, tak rotačních.

Dlouholetá tradice výroby lékařských nástrojů, začínající již v roce 1949, vytvořila know-how umožňující dodávat výrobky vysoké kvality s ohledem na dosažení vysoké míry bezpečnosti odpovídající vysoké úrovni ochrany zdraví. Úroveň, kvalita a bezpečnost všech nástrojů je pečlivě posuzována. Akcent na kvalitu a bezpečnost nástrojů je tradičně zakotven ve firemní politice jakosti a strategii firmy. V kvalitě používá firma účinných postupů dle mezinárodních norem *ISO 9001 Systémy managementu kvality* a *ISO 13485 Systémy jakosti – Zdravotnické prostředky*, jejichž certifikáty jsou pravidelně obnovovány. Důležitou oblastí je splnění legislativních podmínek při uvádění výrobků na trh, zejména evropské direktivy Medical Device 93/42/EHS.

MEDIN, a.s., uplatňuje aktivní postoj k ochraně životního prostředí a praktickou činností směřuje k minimalizaci dopadů vlivů firemních činností na životní prostředí. Komplex výrobních, pomocných a administrativních prostor společnosti splňuje použitými technologiemi a energetickými zdroji přísná ekologická hlediska. Prostřednictvím profesně i odborně způsobilých pracovníků trvale udržuje šetrný vztah k životnímu prostředí. Environmentální management firmy je udržován v souladu s mezinárodní normou *ISO 14001 Systémy environmentálního managementu*.

MEDIN, the joint-stock company, having its headquarters in Nové Město na Moravě commenced its activity on May 4, 1992 as a legal successor of the former state-owned enterprise Chirana Nové Město na Moravě.

MEDIN, the joint-stock company, is the greatest Czech producer of instruments for human medicine in all main fields of medical specialisations, including the bone surgery and implants for traumatology and orthopaedics. It is also the biggest producer of surgery and rotary dental instruments.

A long standing tradition of surgical instruments production, founded as early as 1949, has established a know-how that enables to provide products of high quality and safety corresponding to high level of health protection. The standards, quality and safety of all instruments are carefully evaluated. The quality and safety of the instruments are traditionally anchored in the company's quality policy and company's strategy. We use the effective procedures according to the International Standard *ISO 9001 – Systems of quality management* and *ISO 13485 Quality Systems – Medical Instruments* whose certificates are regularly renewed. It is also very important to follow the legislative conditions when launching the products on the market, mainly the European Directive Medical Devices 93/42/EEC.

MEDIN, the joint-stock company, cares about the environment actively and minimises the impacts of the company's activity on the environment. The complex of production, auxiliary and administration buildings of the company meets the strict environmental aspects with the applied technologies and energy sources.

We permanently keep a considerate relation with our environment through our professionals and specialists. The Environmental management of the company is in conformity with *ISO 14001 – Systems of environmental management*.



397 111 Diagnostika	Diagnostic	9–23
397 112 Nástroje řezné	Cutting Instruments	25–45
397 113 Nůžky	Scissors	47–84
397 114 Pinzety	Forceps	85–110
397 115 Svorky	Clamps, Forceps	111–191
397 116 Kleště štípací	Bone Rongeurs	193–222
397 117 Kleště úchopné	Grasping Forceps	223–246
397 118 Háky	Hooks, Retractors	247–276
397 119 Rozvěrače	Retractors	277–302
397 121 Lopatky	Spatulas	303–308
397 122 Zrcadla	Specula	309–321
397 123 Páčidla	Elevators	323–335
397 124 Škrabky	Raspatories	337–342
397 125 Lžičky	Spoons	343–351
397 126 Kyrety	Curettes	353–358
397 127 Pilky, pilníky	Saws, Files	359–364
397 128 Dláta, kladiva	Chisels, Mallets	365–372
397 131 Frézy, vrtáky	Drills, Burs	373–376
397 132 Jehly, jehelce	Needles, Needle Holders	377–402
397 133 Pátradla	Probes	403–412
397 134 Trokary, odsávačky	Trocars, Suction Tubes	413–422
397 135 Dilatátory	Dilators	423–426
397 136 Speciální nástroje	Special Instruments	427–437
397 139 Soubory	Sets	439–442
397/285 Výrobky z plastů	Plastic products	443–447
397 571 Ostatní	Others	449–451
Číselný rejstřík	Numerical Index	453–498
Jmenný rejstřík	Alphabetical Index	499–513



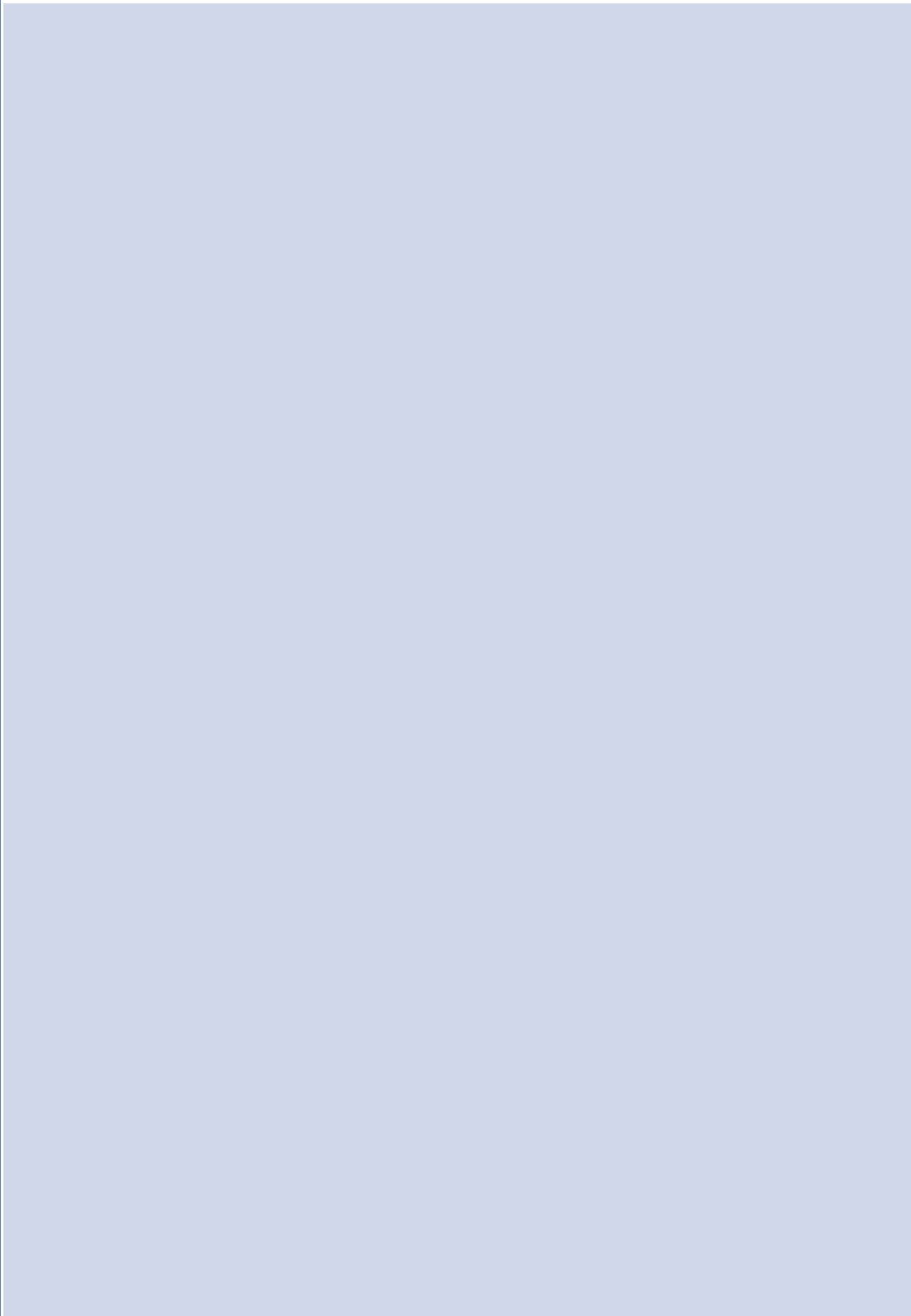



111 91 0003
Fig. 0
55 mm



111 91 0004
Fig. 1
75 mm



111 91 0005
Fig. 2
90 mm



111 91 0006
Fig. 3
110 mm



111 91 0007
Fig. 4
135 mm



McINTOSH
komplet – complete

111 91 0001 (90 mm + 110 mm + 135 mm)
111 91 0002 (75 mm + 90 mm + 110 mm + 135 mm)



LARYNGOSKOPIY
LARYNGOSCOPES

111 91 0010

 Fig. 0
 70 mm

111 91 0011

 Fig. 1
 95 mm

111 91 0012

 Fig. 2
 110 mm

111 91 0013

 Fig. 3
 140 mm

111 91 0014

 Fig. 4
 170 mm

FOREGGER (WISCONSIN)

komplet – complete

111 91 0008 (110 mm + 140 mm + 170 mm)

111 91 0009 (95 mm + 110 mm + 140 mm + 170 mm)



111 91 0017
Fig. 0
55 mm



111 91 0018
Fig. 1
80 mm



111 91 0019
Fig. 2
130 mm



111 91 0020
Fig. 3
170 mm



111 91 0021
Fig. 4
180 mm



MILLER
komplet – complete

111 91 0015 (130 mm + 170 mm + 180 mm)

111 91 0016 (80 mm + 130 mm + 170 mm + 180 mm)



1/2

111 91 0022
Ø 19 mm



1/2

111 91 0023
Ø 28 mm

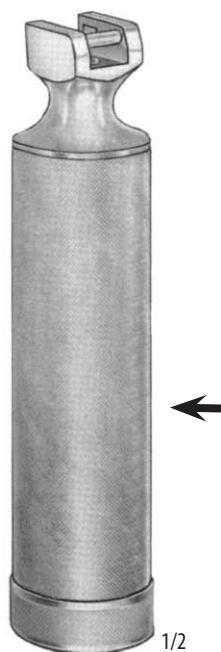

1/2

111 91 0024
Ø 37 mm

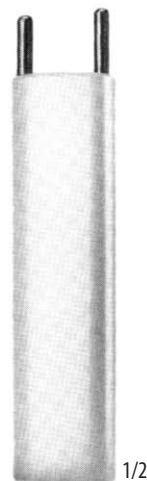

1/2

111 91 0025



1/1

111 91 0026
Fig. 2-4



1/1

111 91 0027
Fig. 0-1

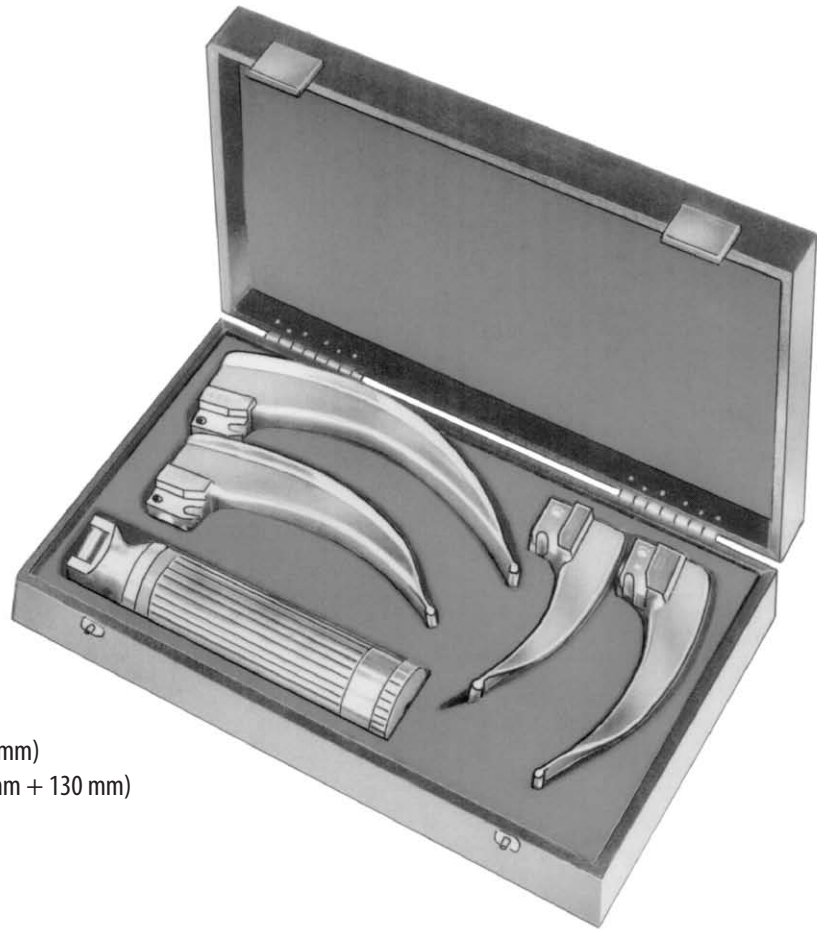

McINTOSH
 STUDENÉ SVĚTLO
 komplet – complete

111 91 0028 (80 mm + 105 mm + 130 mm)

111 91 0029 (70 mm + 80 mm + 105 mm + 130 mm)



111 91 0030	Fig. 0	55 mm
111 91 0031	Fig. 1	70 mm
111 91 0032	Fig. 2	80 mm
111 91 0033	Fig. 3	105 mm
111 91 0034	Fig. 4	130 mm



**FOREGGER
(WISCONSIN)**
STUDENÉ SVĚTLO
komplet – complete

111 91 0035 (110 mm + 140 mm + 170 mm)

111 91 0036 (95 mm + 110 mm + 140 mm + 170 mm)



1/2



111 91 0037	Fig. 0	70 mm
111 91 0038	Fig. 1	95 mm
111 91 0039	Fig. 2	110 mm
111 91 0040	Fig. 3	140 mm
111 91 0041	Fig. 4	170 mm



MILLER
 STUDENÉ SVĚTLO
 komplet – complete

111 91 0042 (80 mm + 130 mm + 170 mm)

111 91 0043 (80 mm + 130 mm + 170 mm + 180 mm)



J

111 91 0044	Fig. 0	55 mm
111 91 0045	Fig. 1	80 mm
111 91 0046	Fig. 2	130 mm
111 91 0047	Fig. 3	170 mm
111 91 0048	Fig. 4	180 mm



111 91 0049
Ø 30 mm



111 91 0050
Ø 20 mm



111 91 0051
2,5 V
Halogen



111 91 0052
2,5 V
Krypton



111 91 0066
komplet – complete

111 91 0067
NÁHRADNÍ ŽÁROVKA
SPARE LAMP



111 91 0068 90 mm
111 91 0069 100 mm



CLAR 55
111 91 0070
6V



CLAR STANDARD
111 91 0071
6V

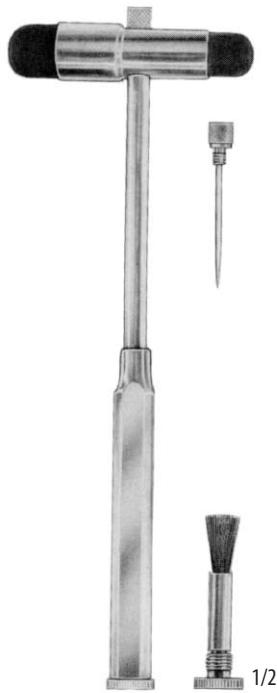

BUCK
111 91 0072
18,0 cm

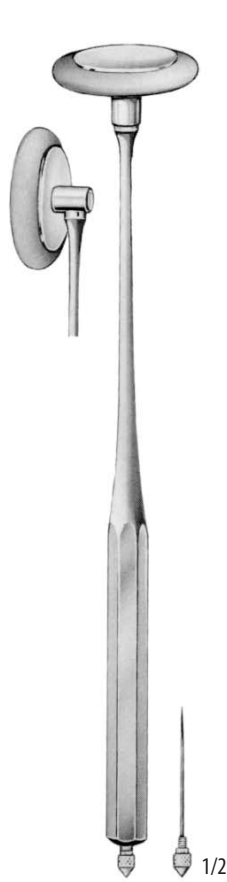

BABINSKY
111 91 0073
22,0 cm
Ø 40 mm

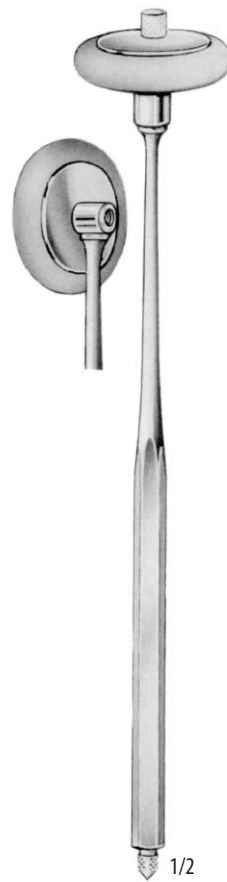

RABINER
111 91 0074
23,0 cm
Ø 40 mm

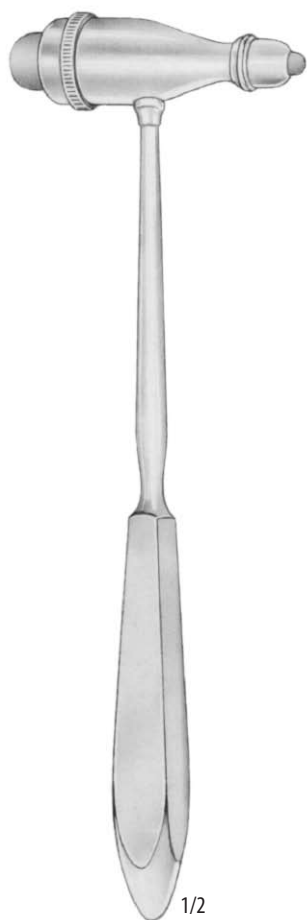

TAYLOR
111 91 0075 – 18,0 cm
111 91 0076 – 20,0 cm

KLADÍVKA
PERCUSSION HAMMERS

TROEMNER
111 91 0077
 24,0 cm

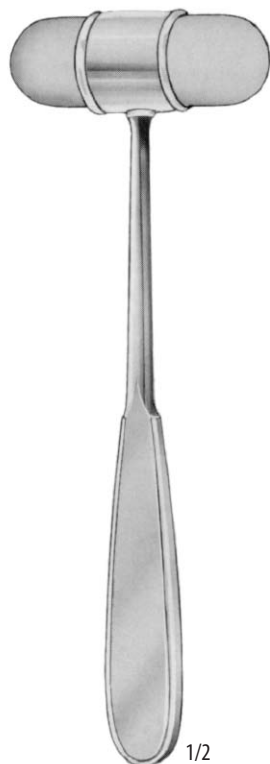

DÉJERINE
111 91 0078
 20,0 cm



DÉJERINE
111 91 0079
 20,0 cm

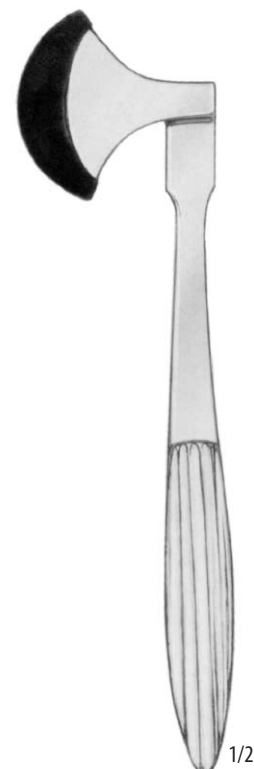

BERLINER
111 91 0080
 20,0 cm

NABĚRAČKA PRO ANATOMII
ANATOMY LADLE

111 01 0010
 19,0 cm
 100 cm³



- 111 91 0081** – 15,0 cm
- 111 91 0082** – 20,0 cm
- 111 91 0083** – 30,0 cm
- 111 91 0084** – 50,0 cm



111 91 0085
150,0 cm



111 91 0086
50,0 cm
pro RTG záření
X-ray

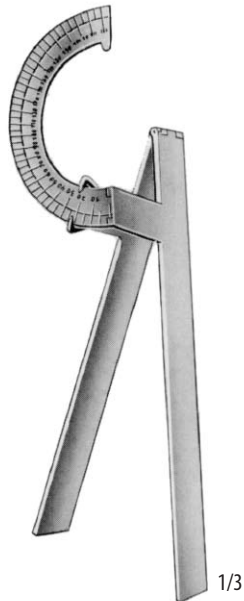

MOELTGEN
111 91 0088

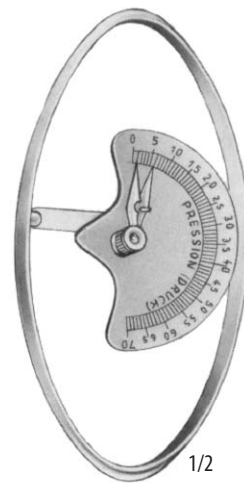

COLLIN
111 91 0090 pro dospělé – adults
111 91 0091 dětský – children







1/1

112 91 0002
12,3 cm



1/1

112 91 0003
12,3 cm



1/1

112 91 0004
13,3 cm



1/1

112 91 0005
20,5 cm



1/1

112 91 0006
20,5 cm

DRŽÁTKA SKALPELOVÝCH ČEPELEK
SCALPEL HANDLES

1/1

112 91 0007

16,5 cm



1/1

COLLIN
112 91 0008

13,3 cm



1/1

112 08 0650

14,0 cm



1/1

112 08 0696

15,0 cm



1/1

UTAHOVACÍ KLÍČEK
SPANNER**112 08 0700**
8,0 cm



112 91 0010
Fig. 10



112 91 0011
Fig. 11



112 91 0012
Fig. 12



112 91 0025
Fig. 12d



112 91 0013
Fig. 13



112 91 0015
Fig. 15



112 91 0026
Fig. 15c

pro držátka
for handles

112 91 0002
112 91 0003
112 91 0005
112 91 0007
112 91 0008



112 91 0018
Fig. 18



112 91 0019
Fig. 19



112 91 0020
Fig. 20



112 91 0021
Fig. 21



112 91 0022
Fig. 22



112 91 0023
Fig. 23



112 91 0024
Fig. 24

pro držátka
for handles

112 91 0004
112 91 0006
112 08 0650

POZNÁMKY: sterilní, balení 100 ks
NOTES: sterile, packing 100 pcs

JEHLY EPILAČNÍ
DEPILATION NEEDLES

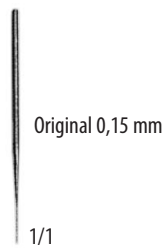

válcová – cylindrical
3,0 cm

112 08 2030
Ø 0,09 mm

112 08 2040
Ø 0,12 mm

112 08 2070
Ø 0,15 mm

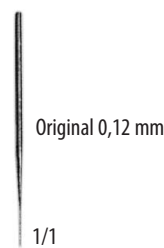

kůželová – conical
3,1 cm

112 08 2090
Ø 0,09 mm

112 08 2080
Ø 0,10 mm

112 08 2100
Ø 0,12 mm

POZNÁMKY: sterilní, balení 10 ks
NOTES: sterile, packing 10 pcs

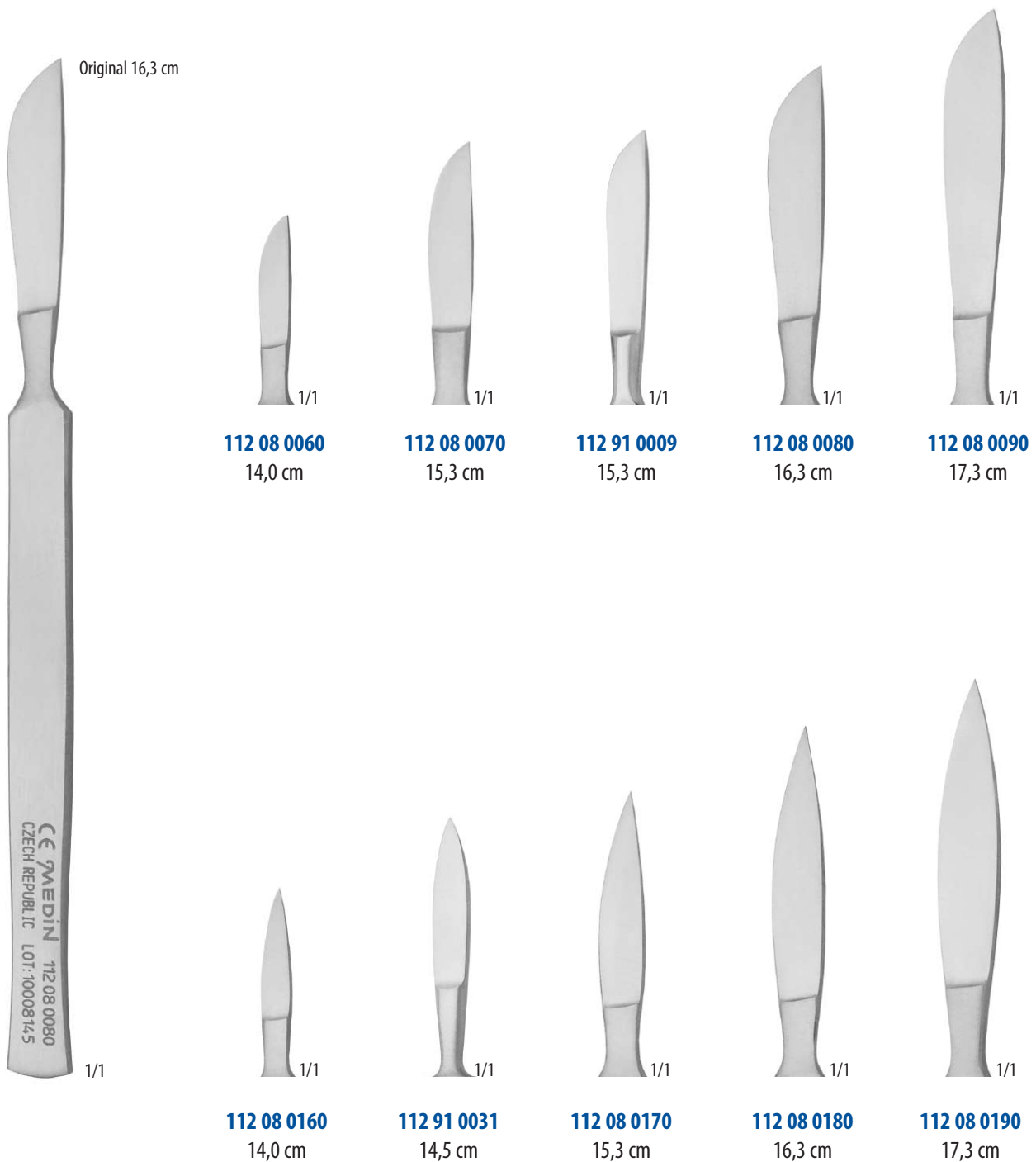
SKALPELY
OPERATING KNIVES

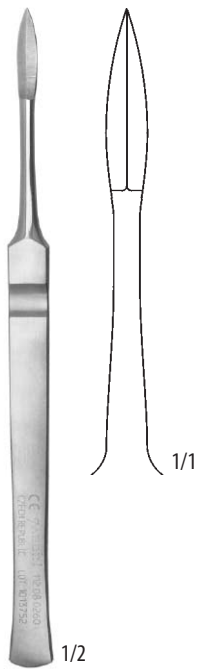

112 08 0260
17,2 cm

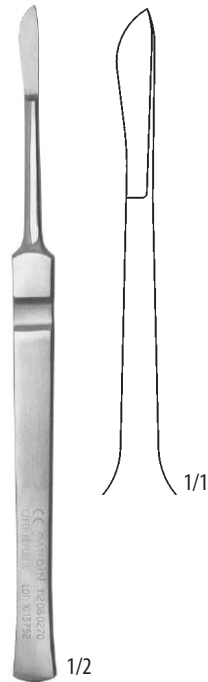

112 08 0270
17,5 cm

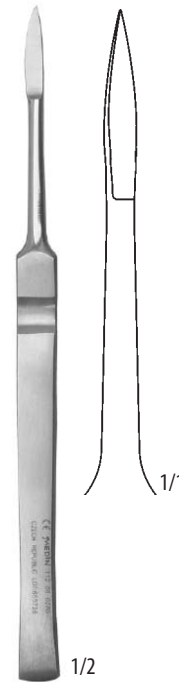

112 08 0280
17,5 cm

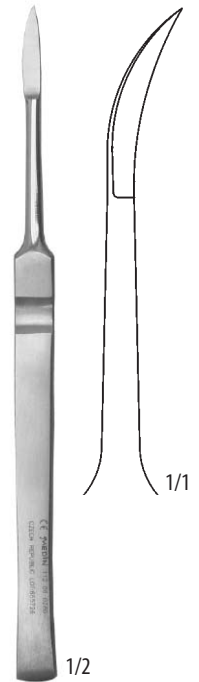

112 08 0290
17,5 cm

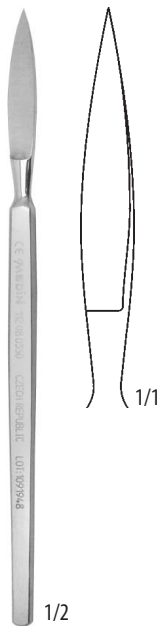

SKALPEL S HRANATÝM DRŽADLEM
OPERATING KNIFE SQUARE HANDLE
112 08 0350
16,3 cm



NŮŽ RESEKČNÍ
RESECTION KNIFE
112 08 0710
17,0 cm

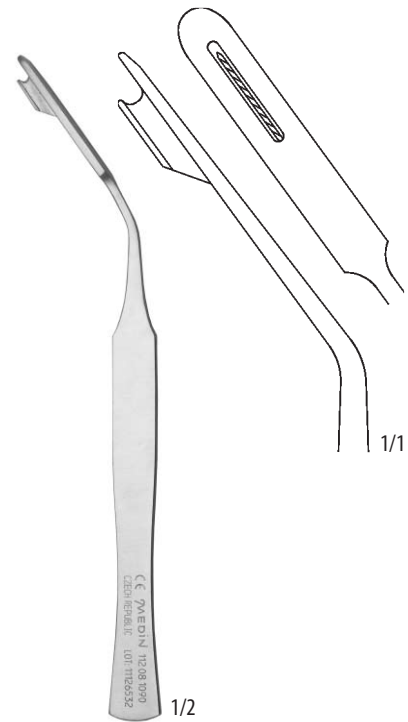

NŮŽ K PROTÍNÁNÍ PŘÍČNÉHO VAZU ZÁPĚSTNÍHO
KNIFE FOR SLASHING CARPAL LIGAMENT
112 08 1090
22,0 cm

SKALPELY OČNÍ
EYE KNIVES**112 38 0010**

Fig. 1

12,5 cm

112 38 0020

Fig. 2

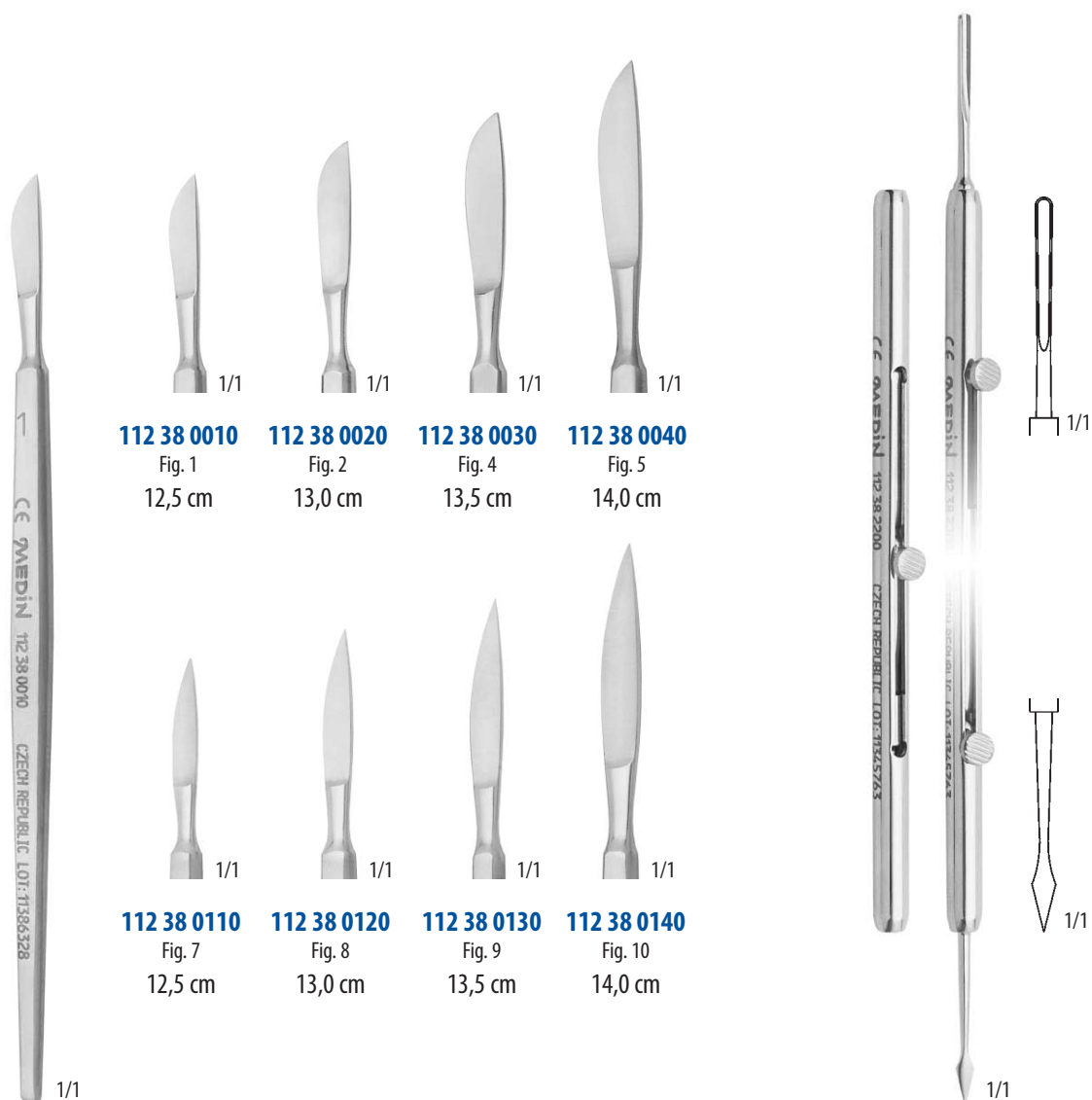
13,0 cm

112 38 0030

Fig. 4

13,5 cm

112 38 0040

Fig. 5

14,0 cm

112 38 0110

Fig. 7

12,5 cm

112 38 0120

Fig. 8

13,0 cm

112 38 0130

Fig. 9

13,5 cm

112 38 0140

Fig. 10

14,0 cm

DIEFFENBACH

12,5 cm

NÁSTROJ DVOJITÝ NA CIZÍ TĚLESO V ROHOVCE
DOUBLE FOREIGN BODY INSTRUMENT**112 38 2200**

10,0 cm

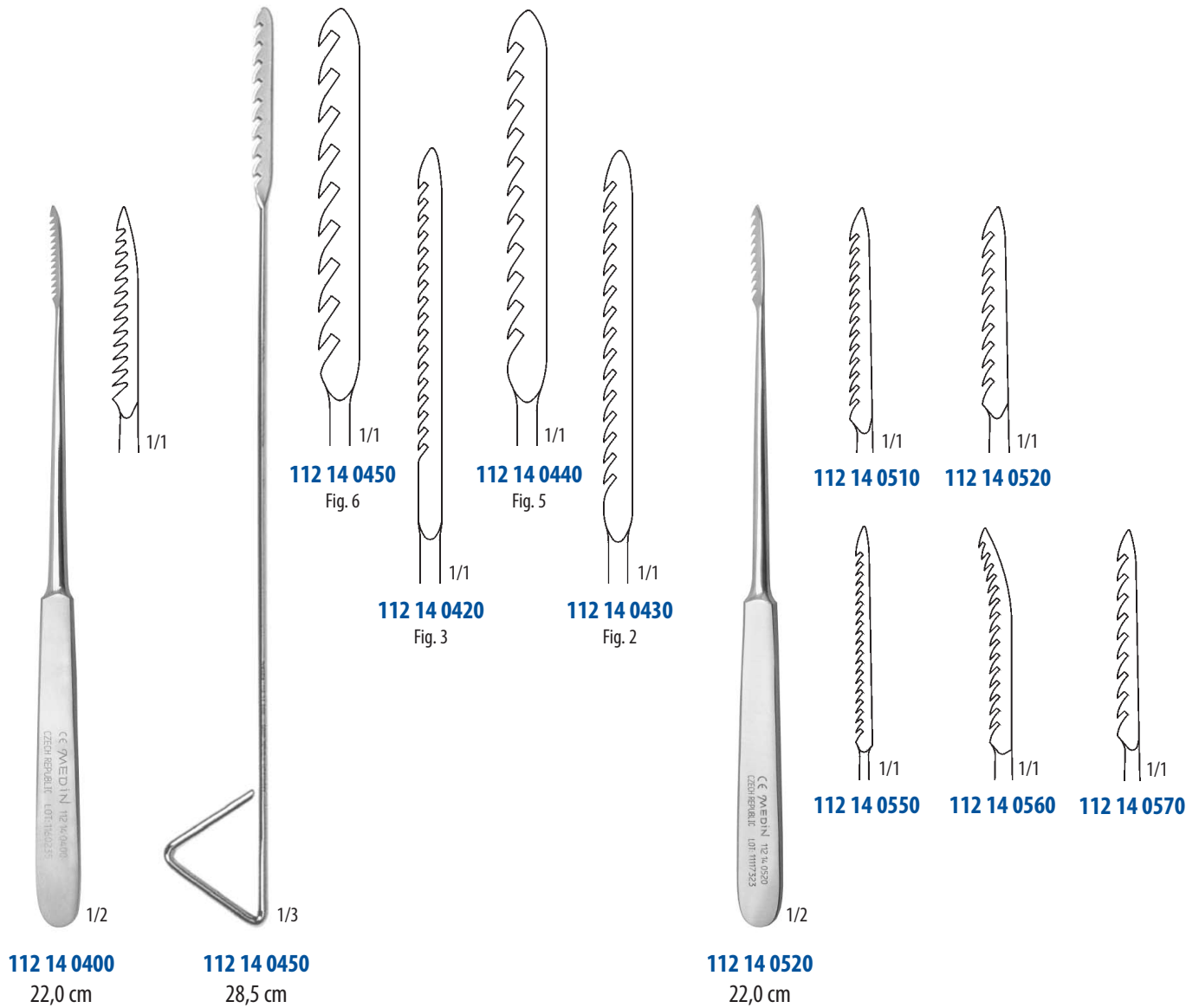

SOUBOR PRO OPERACI VARIXŮ
VARICES OPERATION SET

139 14 0010
soubor – set

		počet ks – number of pcs	
112 14 0680	STRIPPER – 3,5 mm	STRIPPER – 3,5 mm	1
112 14 0690	STRIPPER – 4,5 mm	STRIPPER – 4,5 mm	1
112 14 0700	STRIPPER – 5,0 mm	STRIPPER – 5,0 mm	1
112 14 0710	STRIPPER – 6,0 mm	STRIPPER – 6,0 mm	1
112 14 0720	ELEVATORIUM	ELEVATORIUM	1
112 14 0730	L – DLÁTKO	CHISEL – L	1
112 14 0740	DLÁTKO ROVNÉ	CHISEL STRAIGHT	1
112 14 0750	APLIKÁTOR TAMPONÁDY	APPLICATOR	1
112 14 0760	FASCIOTOM	FASCIOTOM	1

NÁSTROJE NA VARIXY
VARICES INSTRUMENTS

112 14 0680
23,5 cm

STRIPPER

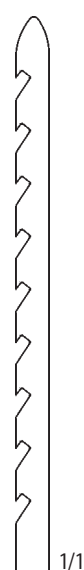

112 14 0690
29,0 cm



112 14 0700
29,0 cm



112 14 0710
29,0 cm



ELEVATORIUM
112 14 0720
25,0 cm

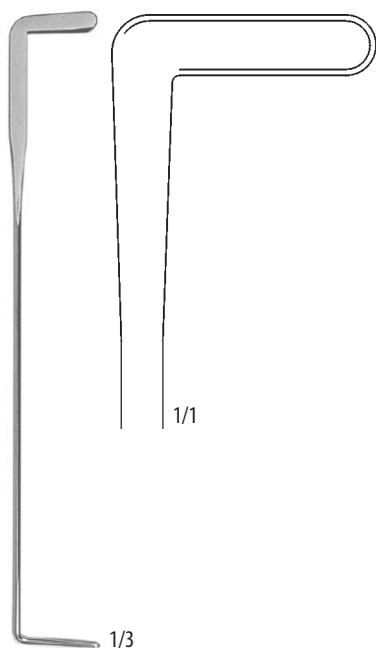

L DLÁTKO
L CHISEL
112 14 0730
25,0 cm

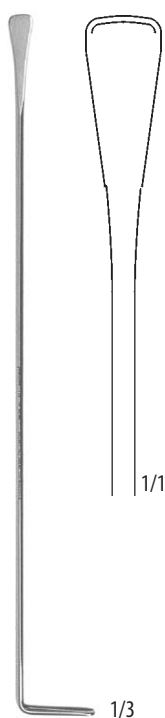

DLÁTKO ROVNÉ
CHISEL STRAIGHT
112 14 0740
27,6 cm



APLIKÁTOR TAMPONÁDY
TAMPONADE APPLICATOR
112 14 0750
27,3 cm

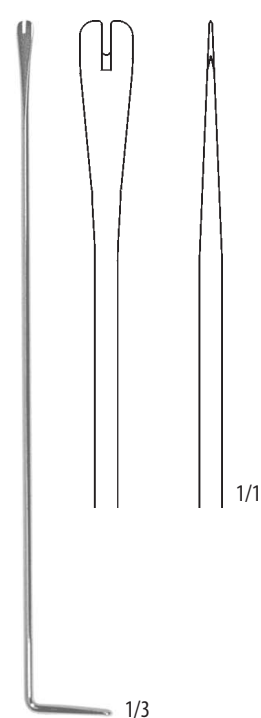

FASCIOTOM
FASCIOTOM
112 14 0760
27,6 cm

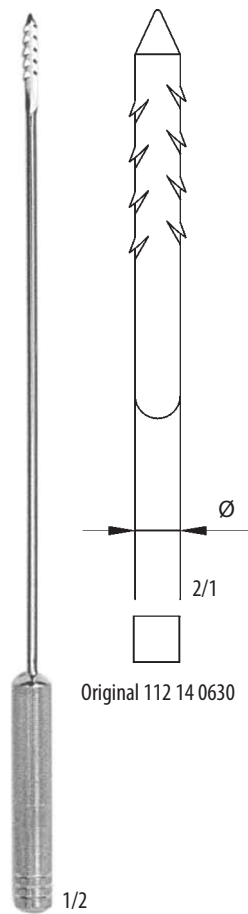

ČTYŘHRAN NA VARIXY
 VARICOSE VEIN KNIFE FOUR-EDGES
 23,7 cm

	Ø	počet drážek na držadle	number of grooves
112 14 0610	1 mm	1 × silná	1 × strong
112 14 0620	2 mm	2 × silná	2 × strong
112 14 0630	3 mm	3 × silná	3 × strong
112 14 0640	4 mm	4 × silná	4 × strong
112 14 0650	1,5 mm	1 × silná + 1 × slabá	1 × strong + 1 × weak
112 14 0660	2,5 mm	2 × silná + 1 × slabá	1 × strong + 1 × weak
112 14 0670	3,5 mm	3 × silná + 1 × slabá	1 × strong + 1 × weak

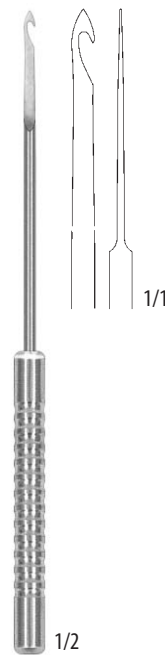

NŮŽ VYPICHOVACÍ
 POKING KNIFE
112 99 0002
 17,0 cm

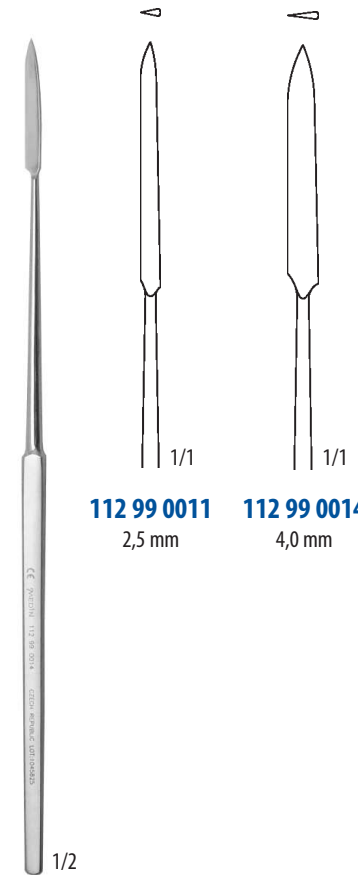

NŮŽ Klapův
 KNIFE Klapův
112 99 0014
 22,0 cm

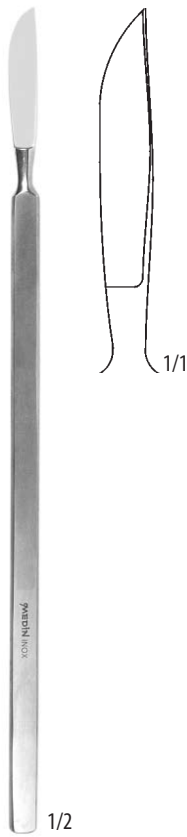

112 27 0040
21,8 cm



112 27 0050
21,1 cm

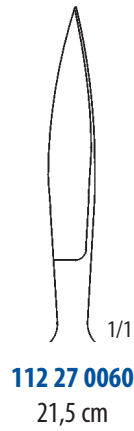

112 27 0060
21,5 cm



SEGOND
112 27 0250
22,3 cm

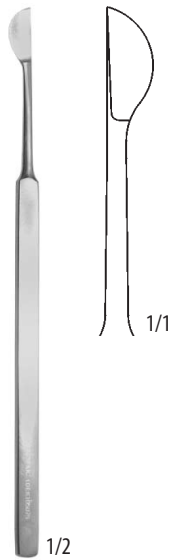

JOSEPH
112 30 0050
14,5 cm



AGNEW
112 29 0010
15,7 cm



SCHWARTZE
112 29 0020
15,7 cm

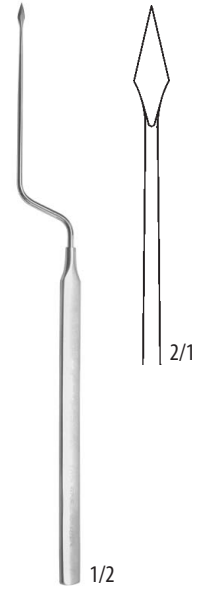

LUCAE
112 29 0040
17,5 cm

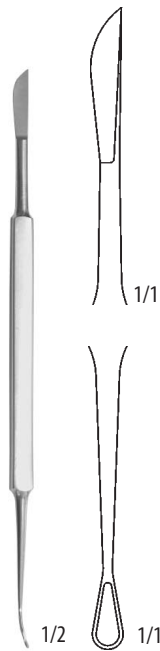

NŮŽ NA FURUNKL
FURUNCLE KNIFE
112 29 0100
15,0 cm

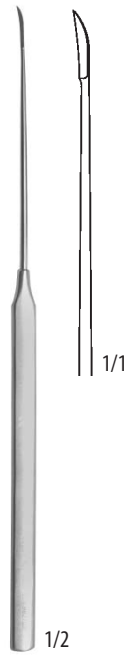

POLITZER
112 29 0110
17,0 cm



SCHWARTZE
112 29 0120
17,0 cm
Fig. 1

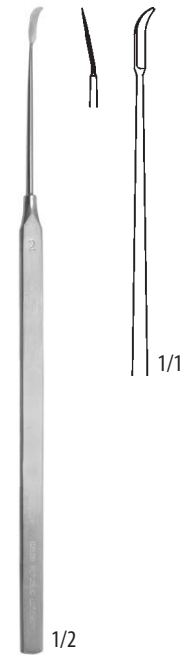

SCHWARTZE
112 29 0130
17,0 cm
Fig. 2

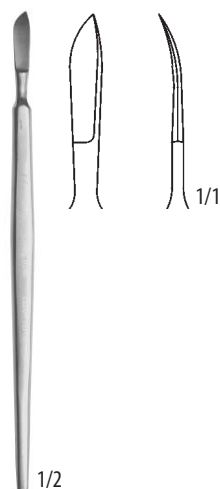

STACKE
112 29 0150
12,6 cm
Fig. 1

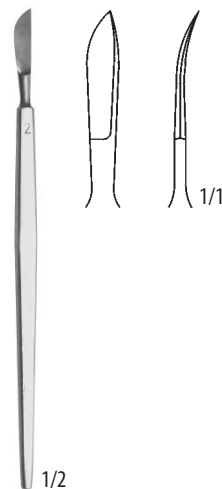

STACKE
112 29 0160
12,6 cm
Fig. 2



HALLE
112 30 0010
12,0 cm

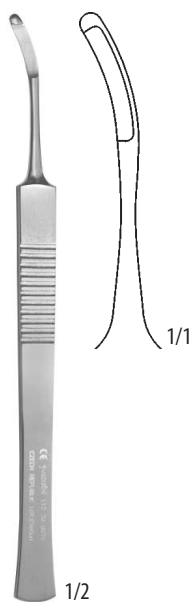

HEYMANN
112 30 0070
15,5 cm

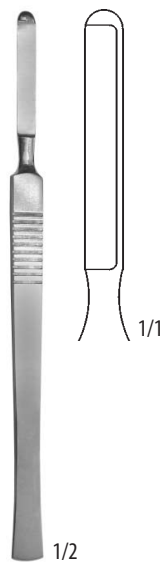

JOSEPH
112 30 0100
14,5 cm

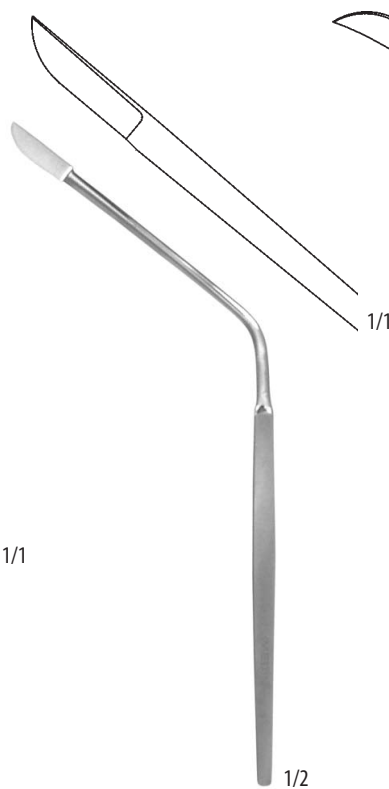

NŮŽ NA FLEGMONU
PHEGMON KNIFE
112 32 0080
17,7 cm

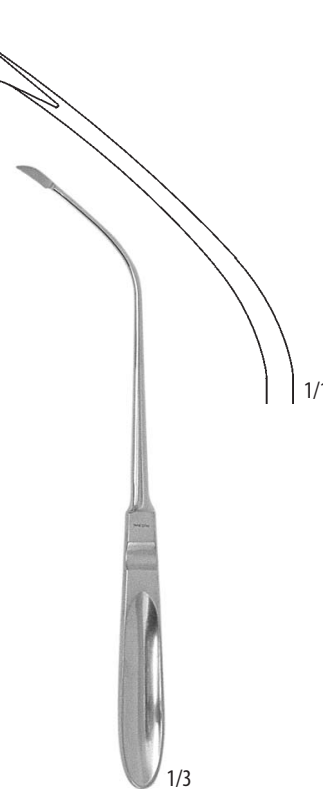

BAGINSKY
112 33 0020
24,5 cm



BALLENGER
112 30 0270
20,0 cm

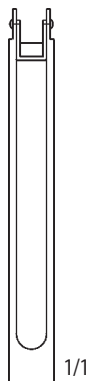

112 30 0260
Fig. 1

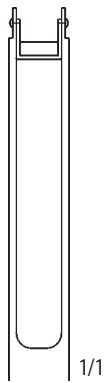

112 30 0270
Fig. 2



BECKMANN

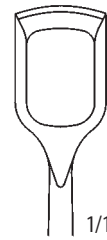

112 30 0300
21,3 mm
Fig. 1

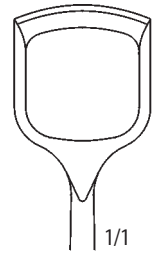

112 30 0320
21,4 mm
Fig. 3



112 30 0310
21,4 mm
Fig. 2

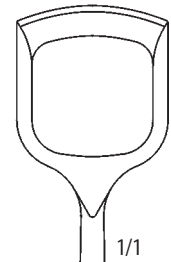

112 30 0330
21,5 mm
Fig. 4

ČEPELE K ADENOTOMU LA FORCE-STEVENSON
BLADES FOR ADENOTOM LA FORCE-STEVENSON



112 30 0450
55 mm
10 mm
Fig. 1



112 30 0460
55 mm
16 mm
Fig. 2



112 30 0470
55 mm
18 mm
Fig. 3

NOŽE PRO OTORHINOLARYNGOLOGII
KNIVES FOR OTORHINOLARYNGOLOGY

LA FORCE
 25,0 cm

Fig. 1

1/1

112 91 0290

neperforovaná čepel – unperforated blade

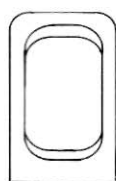
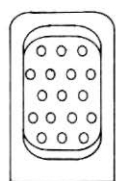

Fig. 4

1/1

112 91 0284

perforovaná čepel – perforated blade

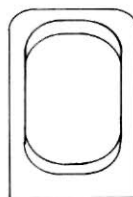

Fig. 2

1/1

112 91 0291

neperforovaná čepel – unperforated blade

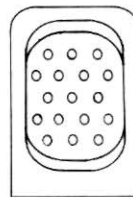

Fig. 5

1/1

112 91 0285

perforovaná čepel – perforated blade

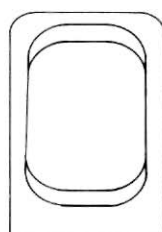

Fig. 3

1/1

112 91 0292

neperforovaná čepel – unperforated blade

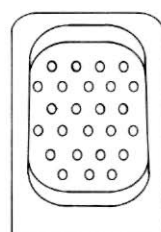

Fig. 6

1/1

112 91 0286

perforovaná čepel – perforated blade

ČEPELE K ADENOTOMU LA FORCE
BLADES FOR ADENOTOM LA FORCE

original Fig. 1

1/1

neperforovaná – unperforated

112 91 0293 Fig. 1**112 91 0294** Fig. 2**112 91 0295** Fig. 3

original Fig. 4

1/1

perforovaná – perforated

112 91 0287 Fig. 4**112 91 0288** Fig. 5**112 91 0289** Fig. 6



1/2

COLLIN

112 91 0062

26,0 cm

délka čepele – length of blade
13,0 cm

112 08 0740

29,0 cm

délka čepele – length of blade
16,0 cm

112 08 0770

35,0 cm

délka čepele – length of blade
22,0 cm



1/2

CATLIN

112 91 0067

29,0 cm

délka čepele – length of blade
16,0 cm

112 91 0069

35,0 cm

délka čepele – length of blade
22,0 cm



1/2

LANGENBECK

112 08 0730

24,0 cm

délka čepele – length of blade
11,5 cm

112 91 0073

25,0 cm

délka čepele – length of blade
12,0 cm



1/2

REINER

112 05 0010

18,4 cm



1/2

VIRCHOW
112 01 0210
28,6 cm



1/2

NŮŽ NA CHRUPAVKU
CARTILAGE KNIFE
112 01 0030
20,5 cm



1/2

NŮŽ PITEVNÍ
POST MORTEM KNIFE
112 01 0240
24,0 cm



1/2

NŮŽ PITEVNÍ
POST MORTEM KNIFE
112 01 0250
25,5 cm



112 02 0100
13,6 cm
Fig. 1



112 02 0110
13,4 cm
Fig. 2



112 02 0300
13,6 cm



KLÍČKA NA VÝTĚRY
WIRE LOOP FOR MICROSCOPY
112 02 0410
7,0 cm
Ø 3,1 mm

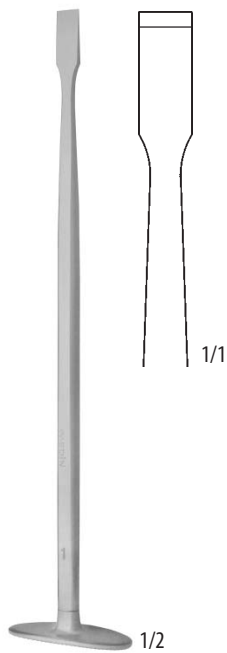

112 09 0010
17,0 cm
Fig. 1

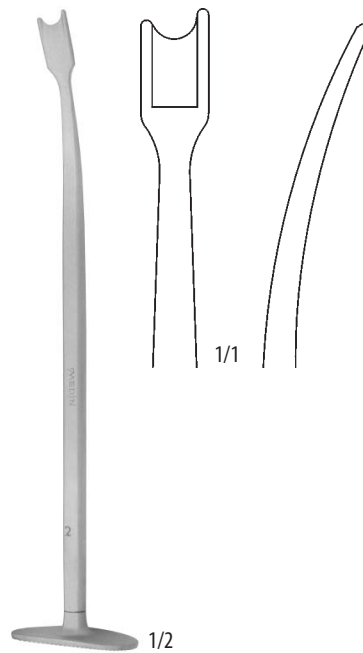

112 09 0020
16,8 cm
Fig. 2

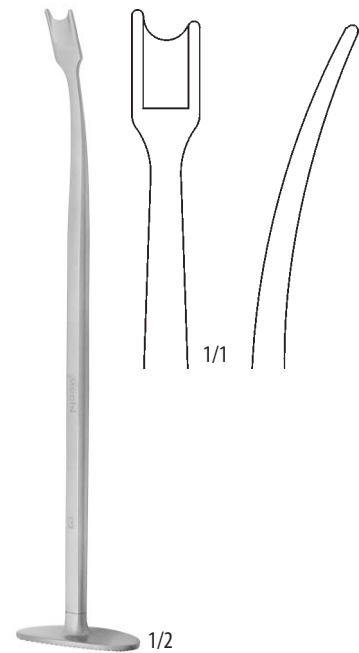

112 09 0030
16,8 cm
Fig. 3

NOŽE TRANSPLANTAČNÍ
TRANSPLANTATION KNIVES

1/2

REHN
112 91 0087
 25,0 cm

1/2

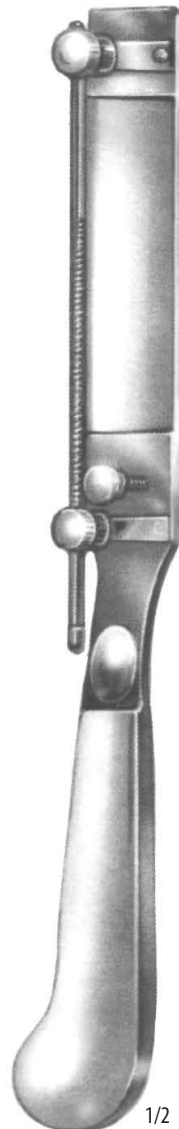
THIERSCH
112 12 0020
 23,5 cm

1/2

SCHINK
112 91 0088
 30 cm

1/2

ČEPEL K TRANSPLANTAČNÍMU NOŽI SCHINK
BLADE FOR TRANSPLANTATION KNIFE SCHINK
112 91 0089
 12 cm



1/2
HUMBY
112 12 0120
33,4 cm



1/2
112 12 0130
15,8 cm



1/2
HUMBY
112 12 0230
37,5 cm

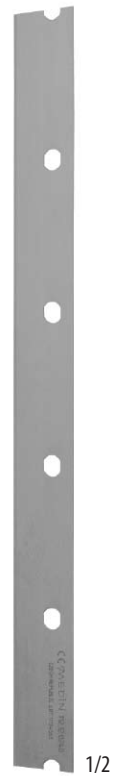

1/2
112 12 0240
19,8 cm







113 01 0210
rovné – straight
22,0 cm



113 01 0230
zahnuté – curved
22,0 cm

NŮŽKY CHIRURGICKÉ
SURGICAL SCISSORS



NŮŽKY CHIRURGICKÉ NA INCISI
INCISION SCISSORS
113 91 0071 – 13,0 cm
113 91 0072 – 14,5 cm
113 08 0810 – 15,0 cm



RICHTER
113 05 0010
15,0 cm



RICHTER
113 05 0020
15,0 cm



DEAVER
113 91 0077
14,0 cm

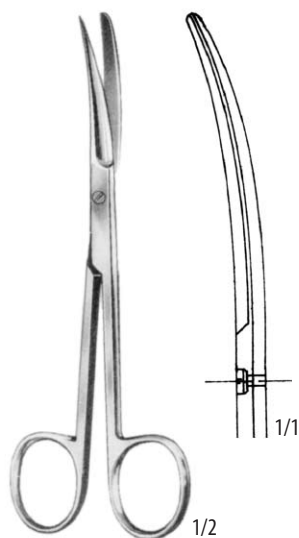

DEAVER
113 91 0078
14,0 cm

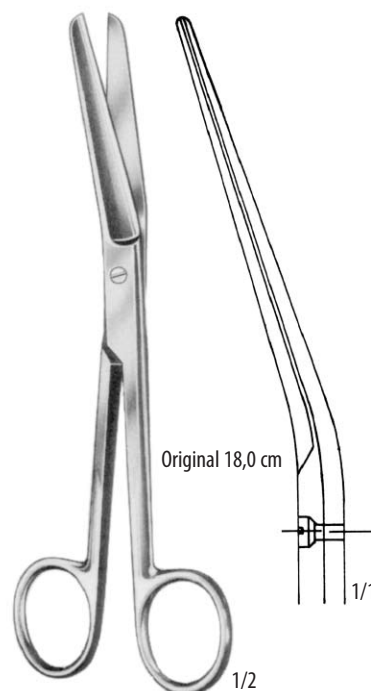

FERGUSSON
113 91 0075
16,5 cm
113 91 0076
18,0 cm

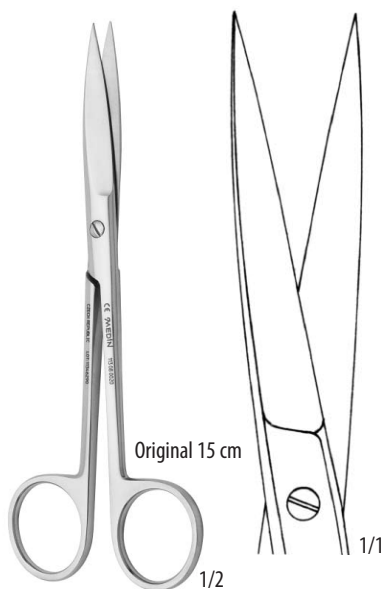

STANDARD

rovne – straight	zahnute – curved
113 91 0042 – 11,5 cm	– 113 91 0051
113 08 0010 – 13,0 cm	– 113 08 0310
113 08 0020 – 15,0 cm	– 113 08 0320
113 91 0046 – 16,5 cm	– 113 91 0055
113 08 0040 – 18,5 cm	– 113 08 0340
113 91 0049 – 20,0 cm	– 113 91 0058
113 08 0060 – 22,0 cm	– 113 08 0360
113 08 0070 – 30,0 cm	– 113 08 0370

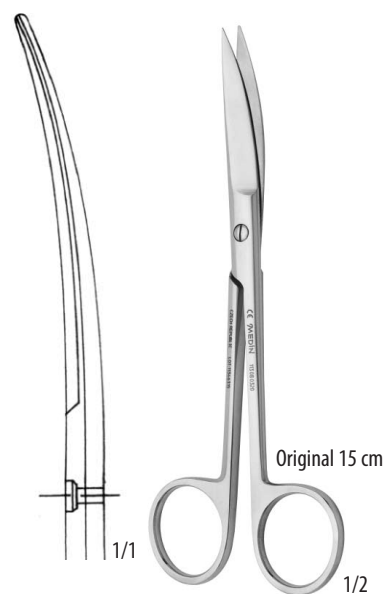

STANDARD

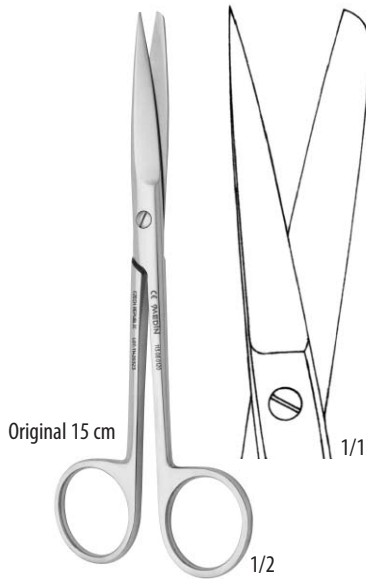

STANDARD

rovné – straight	zahnuté – curved
113 91 0020 – 11,5 cm	– 113 91 0031
113 08 0110 – 13,0 cm	– 113 08 0410
113 08 0120 – 15,0 cm	– 113 08 0420
113 91 0026 – 16,5 cm	– 113 91 0037
113 08 0140 – 18,5 cm	– 113 08 0440
113 91 0029 – 20,0 cm	– 113 91 0040
113 08 0160 – 22,0 cm	– 113 08 0460
113 08 0170 – 30,0 cm	– 113 08 0470

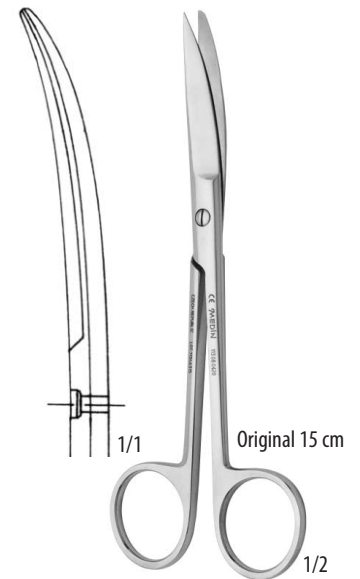

STANDARD

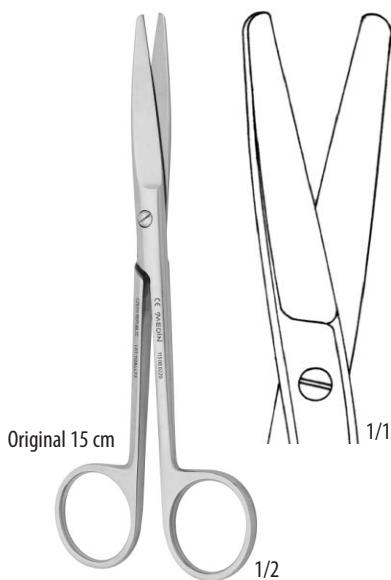

STANDARD

rovné – straight	zahnuté – curved
113 91 0002 – 11,5 cm	– 113 91 0011
113 08 0210 – 13,0 cm	– 113 08 0510
113 08 0220 – 15,0 cm	– 113 08 0520
113 91 0006 – 16,5 cm	– 113 91 0015
113 08 0240 – 18,5 cm	– 113 08 0540
113 91 0009 – 20,0 cm	– 113 91 0018
113 08 0260 – 22,0 cm	– 113 08 0560
113 08 0270 – 30,0 cm	– 113 08 0570

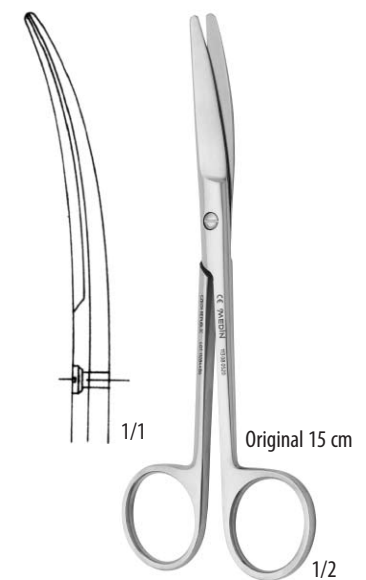

STANDARD

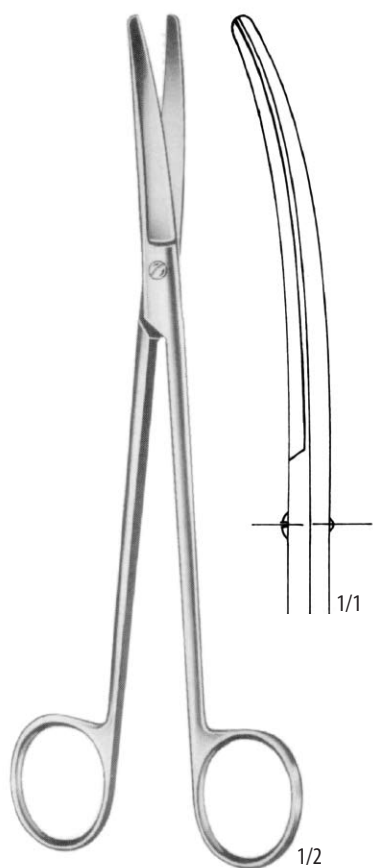

WERTHEIM
113 91 0116
22,5 cm



BRAUN-STADLER
113 91 0317
14,0 cm



BRAUN-STADLER
113 91 0318
22,0 cm

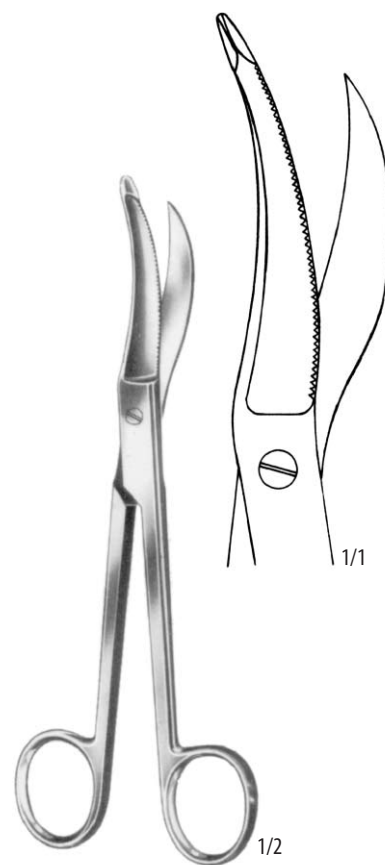

WALDMANN
113 91 0319
18,0 cm



KELLY
113 91 0110
rovné – straight
16,0 cm

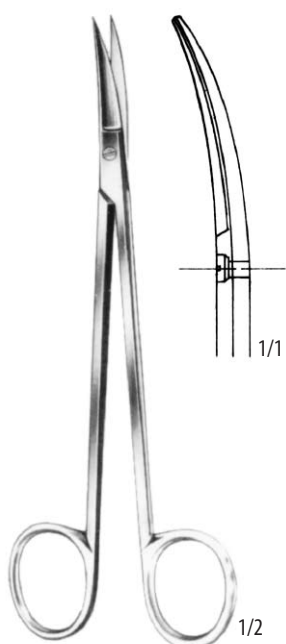

KELLY
113 91 0112
zahnuté – curved
16,0 cm



DOYEN
113 91 0106
rovné – straight
16,0 cm



DOYEN
113 91 0107
zahnuté – curved
16,0 cm

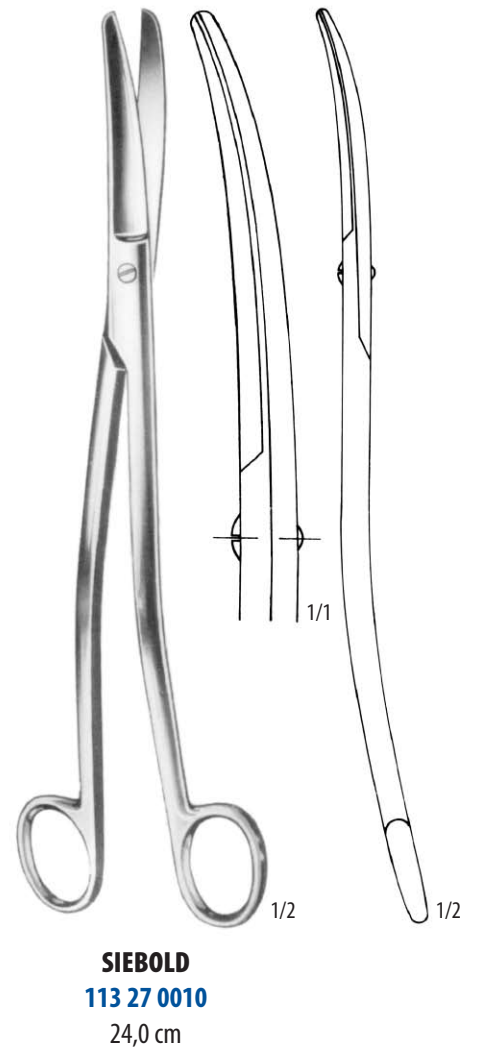
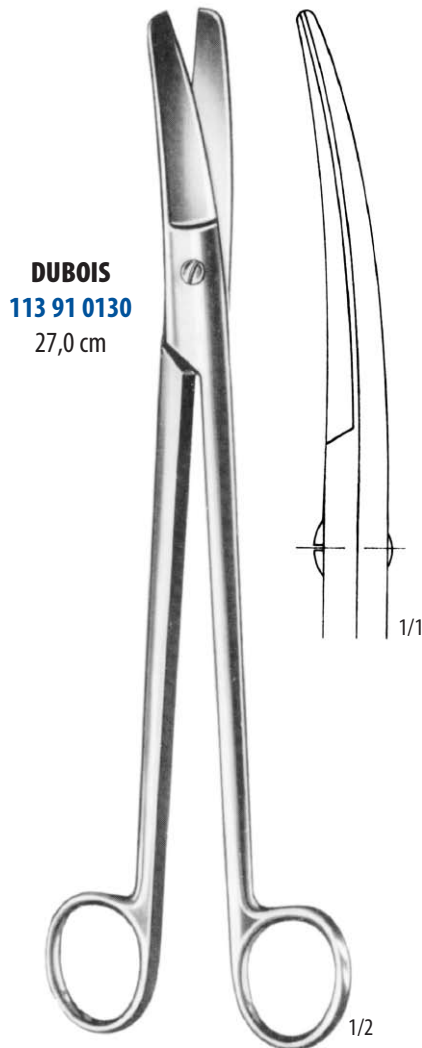
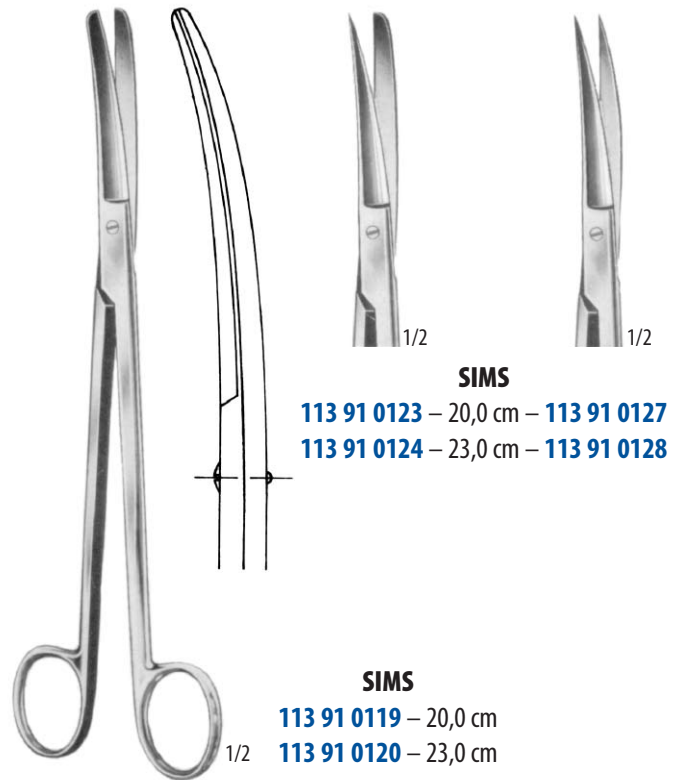
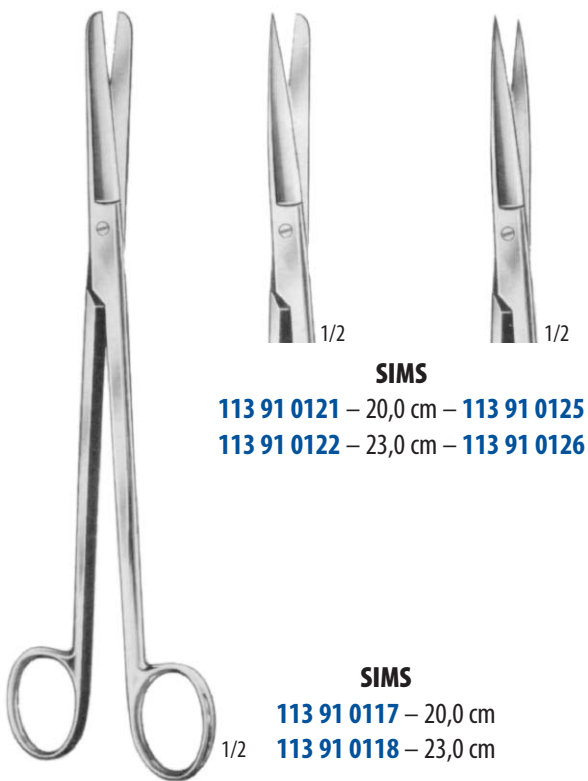

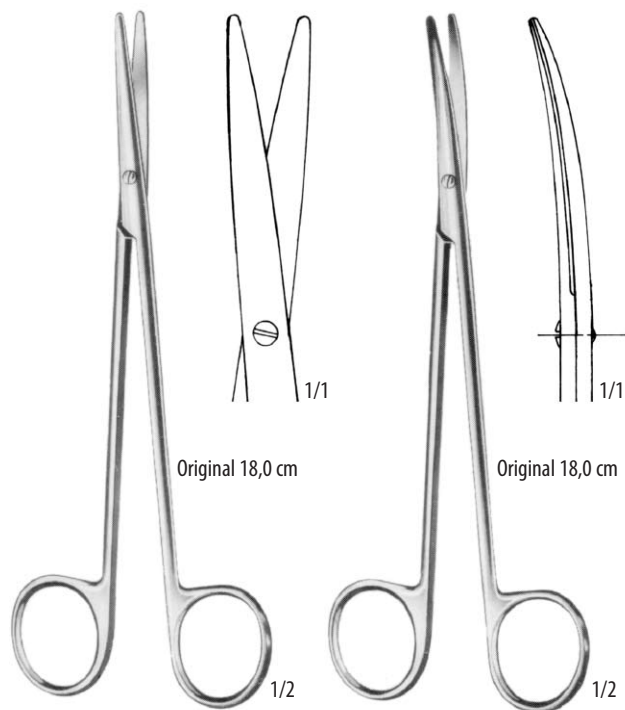
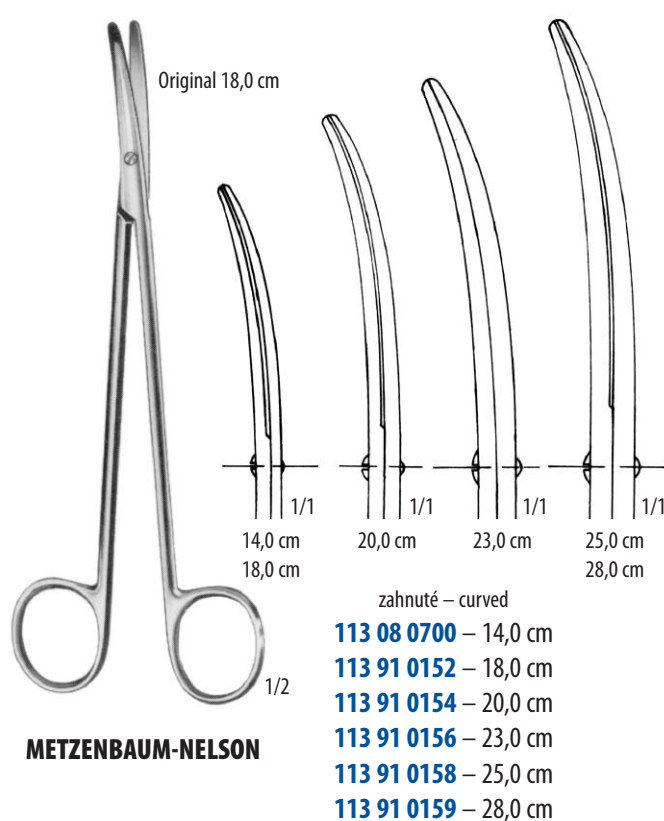
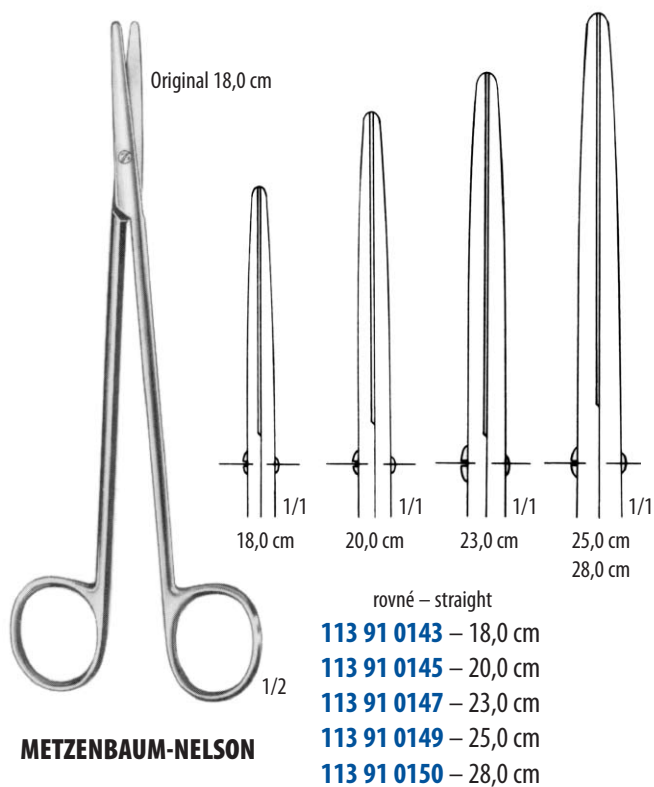
**METZENBAUM-DELICATE**

rovné – straight zahnuté – curved

113 91 0189 – 18,0 cm – **113 91 0195**
113 91 0190 – 20,0 cm – **113 91 0196**
113 91 0191 – 23,0 cm – **113 91 0197**
113 91 0192 – 25,0 cm – **113 91 0198**

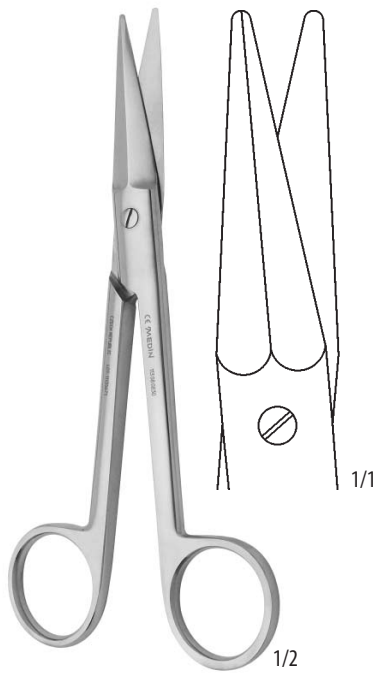

MAYO
113 08 0830
rovné – straight
17,0 cm

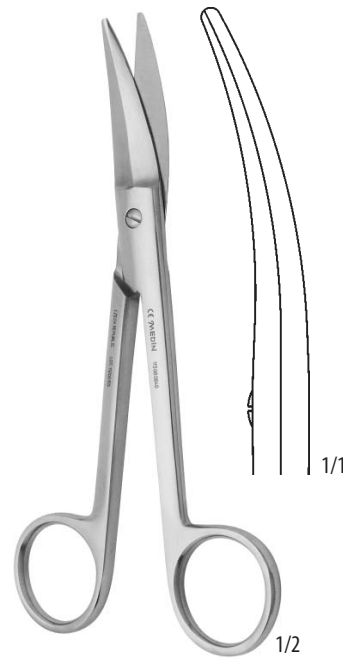

MAYO
113 08 0840
zahnuté – curved
16,8 cm

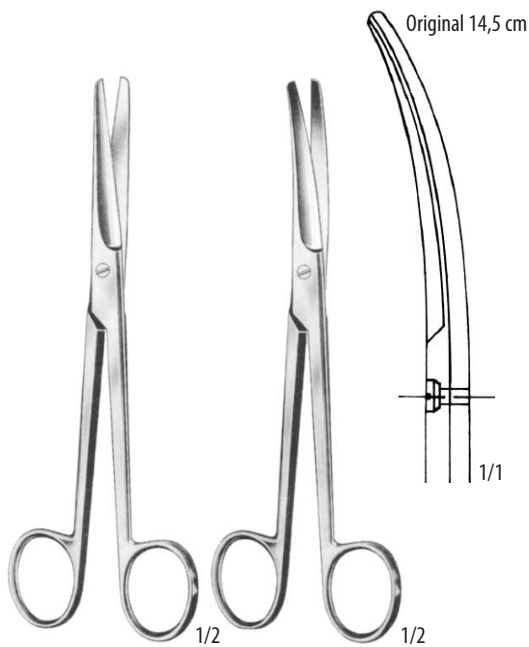

MAYO
rovné – straight zahnuté – curved
113 91 0083 – 14,5 cm – **113 91 0090**
113 91 0087 – 23,0 cm – **113 91 0094**

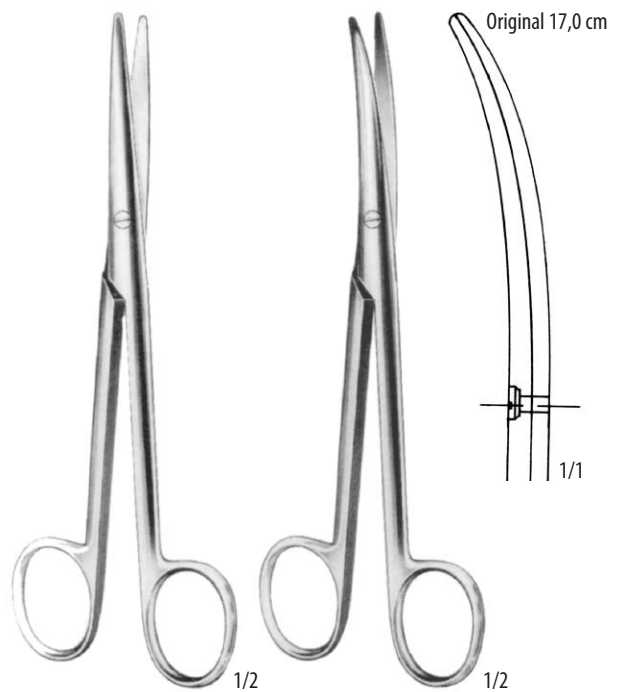

MAYO-STILLE
rovné – straight zahnuté – curved
113 91 0097 – 15,0 cm – **113 91 0101**
113 91 0098 – 17,0 cm – **113 91 0102**

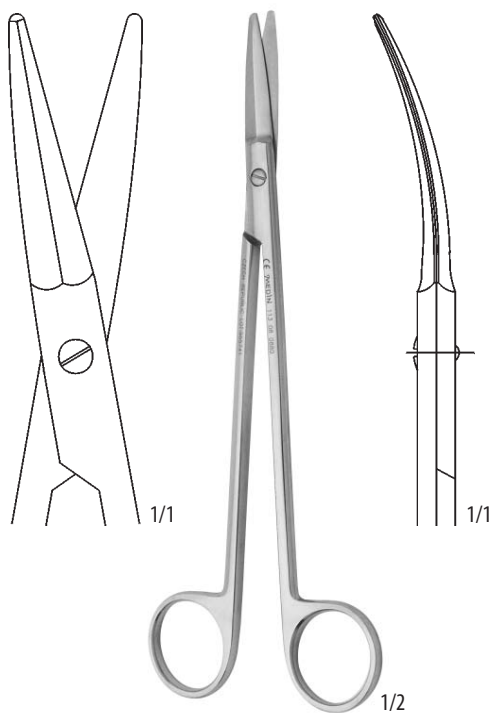

113 08 0880
rovné – straight
18,5 cm

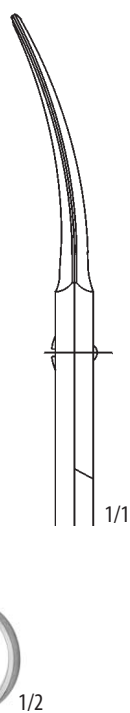

113 08 0890
zahnuté – curved
18,5 cm

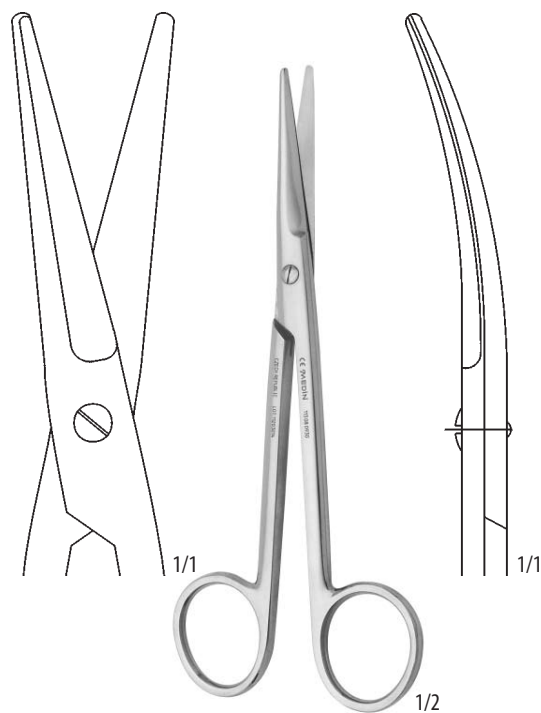

113 08 0930
rovné – straight
17,0 cm

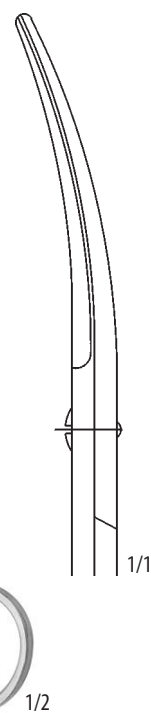

113 08 0940
zahnuté – curved
17,0 cm



FOMON
113 91 0217
13,5 cm

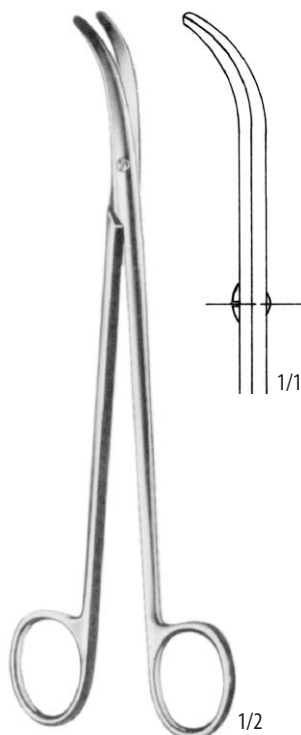

THOREK
113 91 0218
19,0 cm



LEXER-BABY
113 91 0219
rovné – straight
10,0 cm

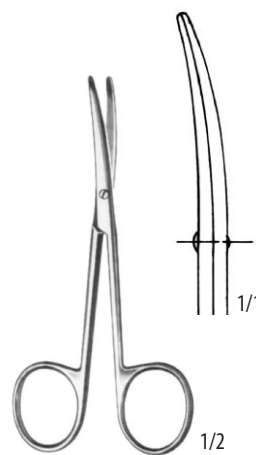

LEXER-BABY
113 91 0220
zahnuté – curved
10,0 cm

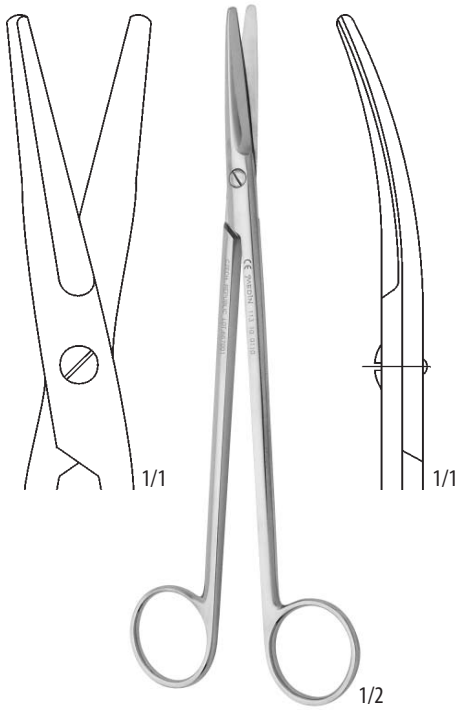

113 10 0110
rovné – straight
18,5 cm

113 10 0120
zahnuté – curved
18,5 cm

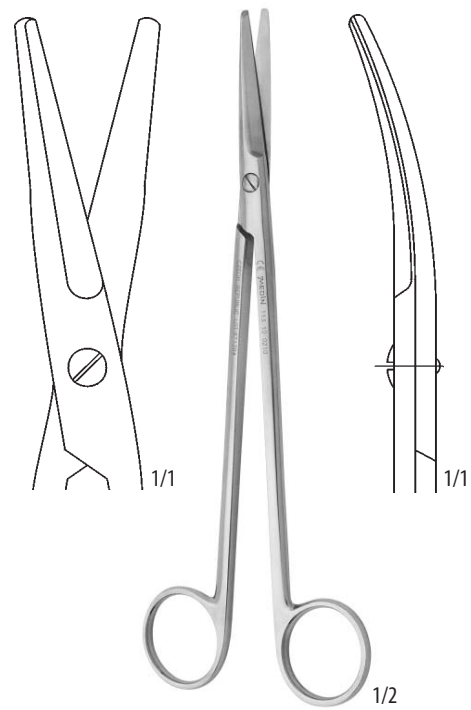

113 10 0210
rovné – straight
18,5 cm

113 10 0220
zahnuté – curved
18,5 cm



LEXER
113 91 0215
16,0 cm

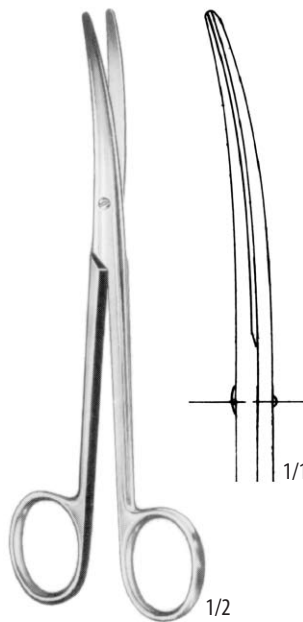

LEXER
113 91 0216
16,0 cm

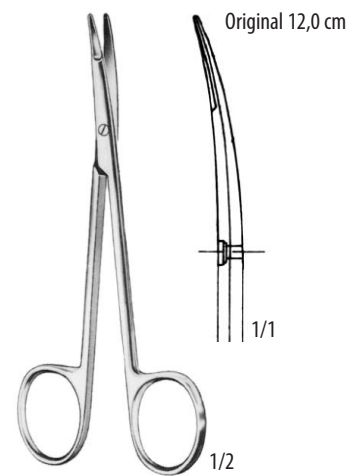

KILNER (RAGNELL)
113 91 0229
12,0 cm
113 91 0230
15,0 cm



SANVENERO
rovné – straight
113 91 0221
14,0 cm

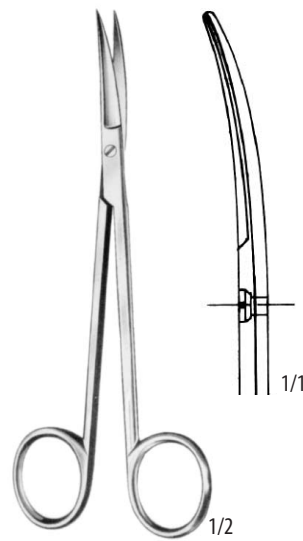

SANVENERO
zahnuté – curved
113 91 0222
14,0 cm



REYNOLDS
113 91 0233
rovné – straight
15,0 cm

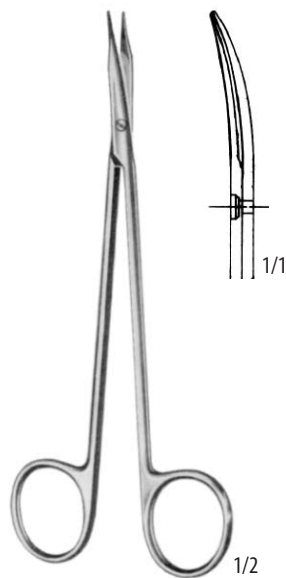

REYNOLDS
113 91 0235
zahnuté – curved
15,0 cm

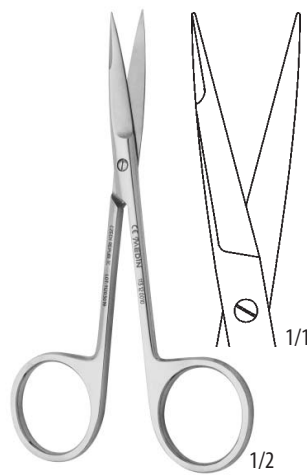

113 12 0010
rovné – straight
12,0 cm

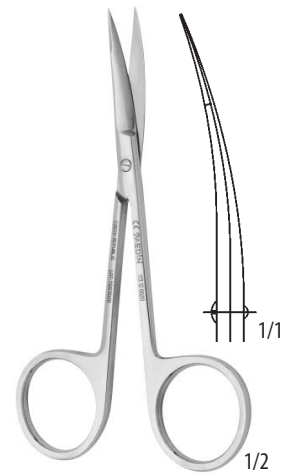

113 12 0020
zahnuté – curved
12,0 cm

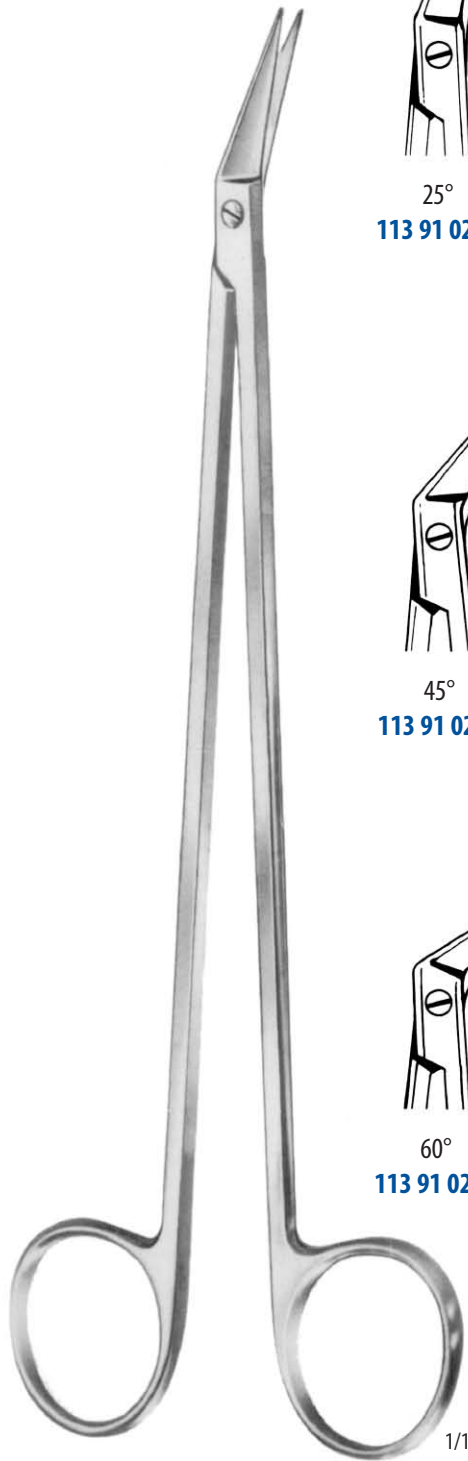

25°
113 91 0237



45°
113 91 0238

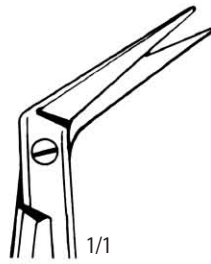

60°
113 91 0239

POTTS-SMITH
19,0 cm

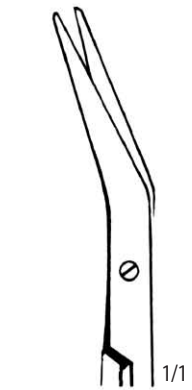
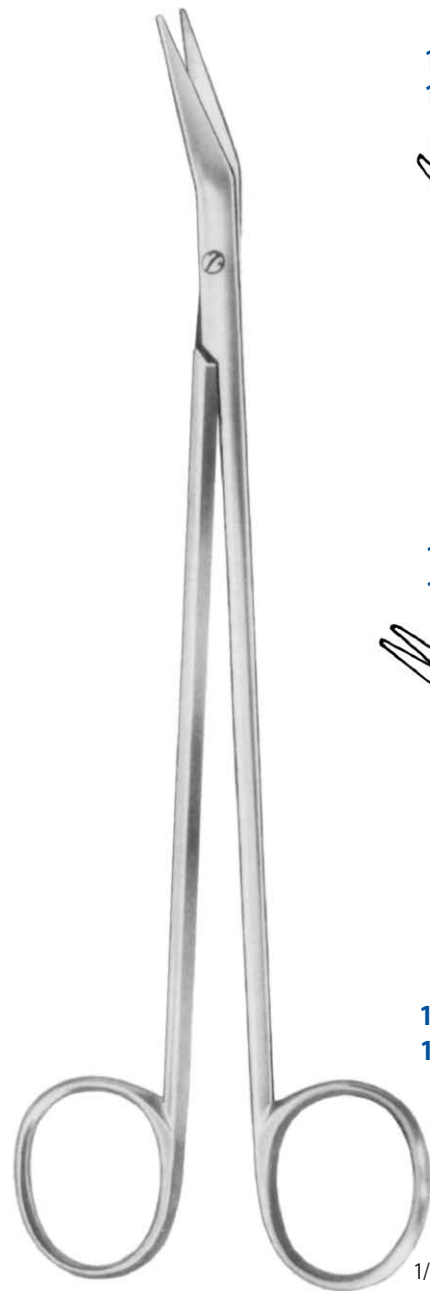

25°
113 91 0240 – 16,0 cm
113 91 0242 – 23,0 cm

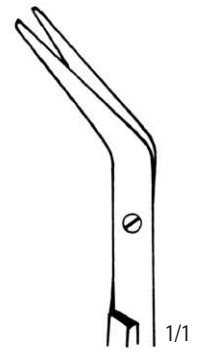

45°
113 91 0244 – 16,0 cm
113 91 0246 – 23,0 cm

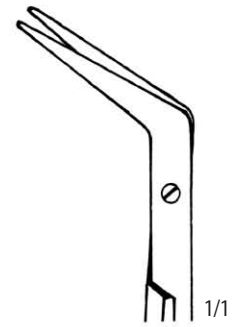

60°
113 91 0248 – 16,0 cm
113 91 0250 – 23,0 cm

DE BAKEY
16,0 cm

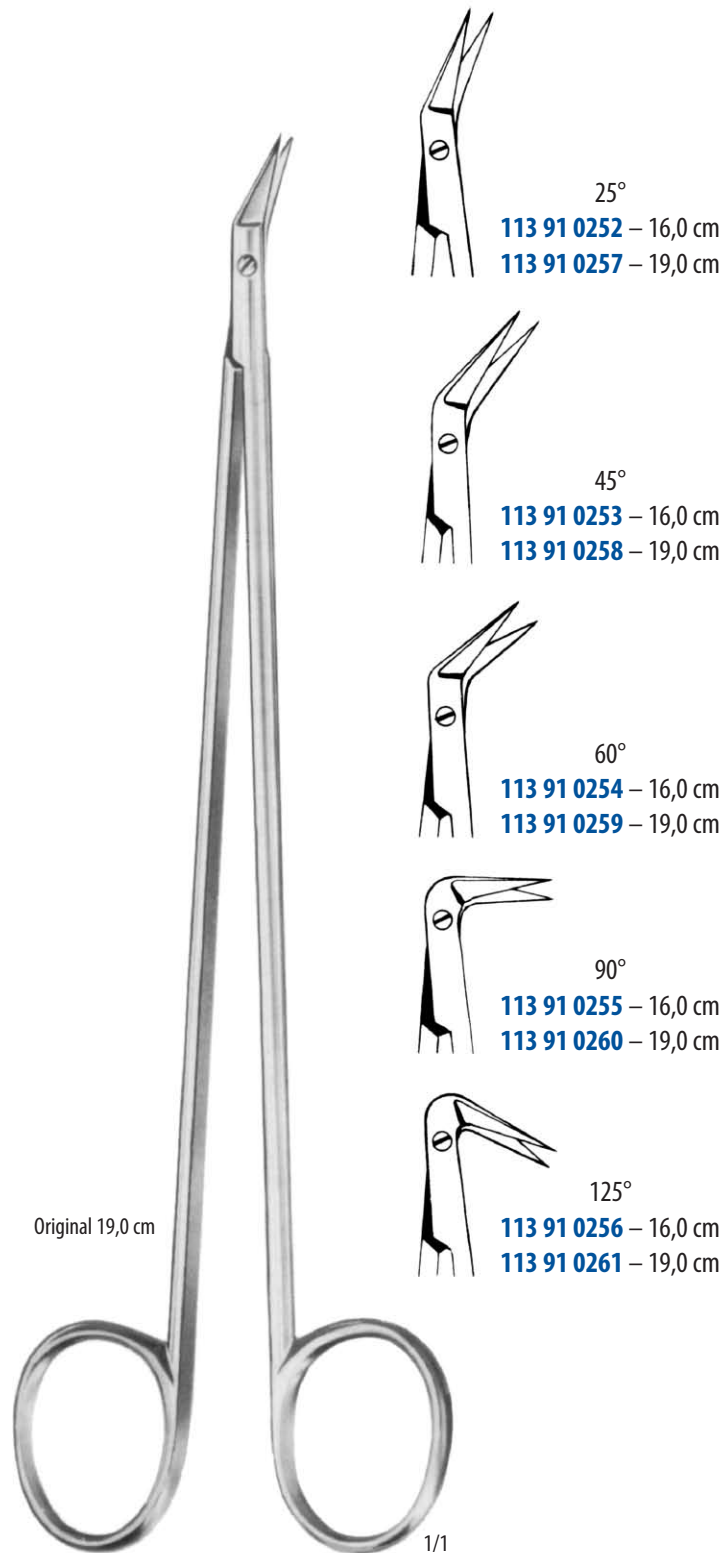
**HEGEMANN-DIETRICH**

16,0 cm

19,0 cm

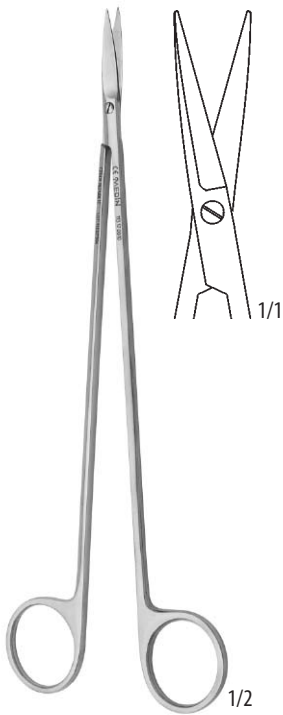

rovné – straight
113 17 0010
19,0 cm

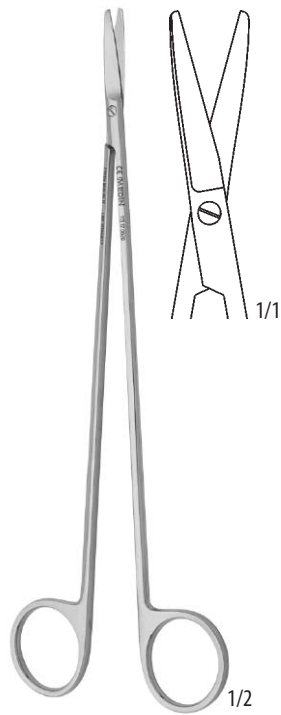

rovné – straight
113 17 0020
19,0 cm

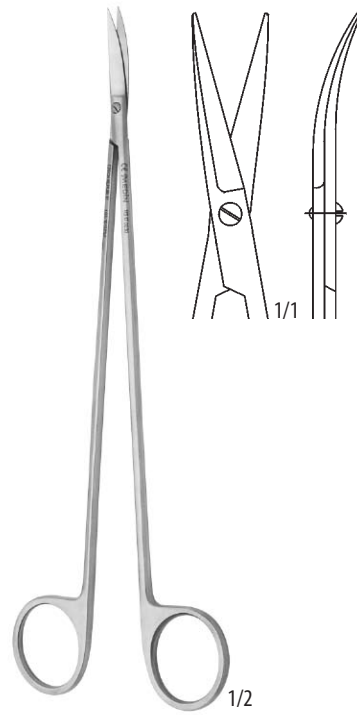

zahnuté – curved
113 17 0030
19,0 cm

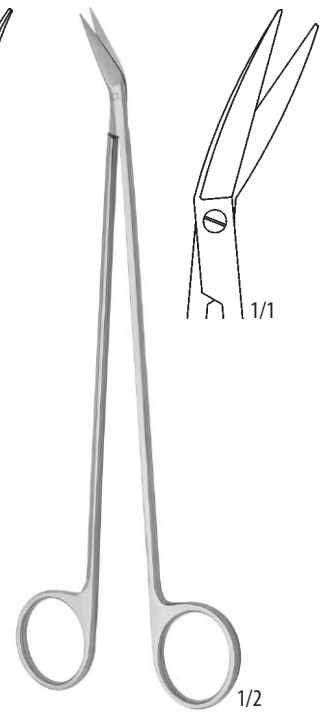

angled – lomené
113 17 0040
19,0 cm



STRULLY
113 91 0267
22,0 cm

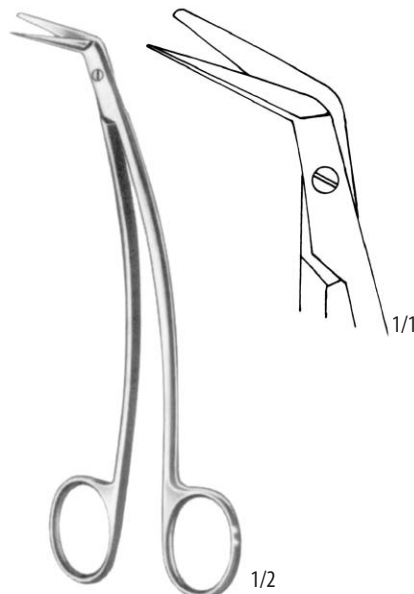

FAVALORO
113 91 0270
15,0 cm

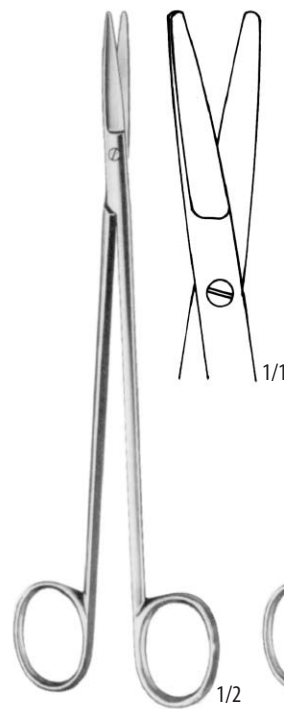

TOENNIS
113 91 0278
18,0 cm

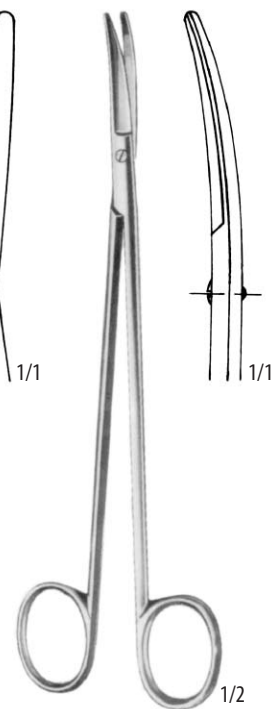

113 91 0279
18,0 cm

**KLINKENBERGH-LOTH****113 91 0280**

23,0 cm

SATINSKY**113 91 0281**

24,5 cm

**SCHMIEDEN-TAYLOR****113 91 0275**

14,5 cm

113 91 0276

17,0 cm

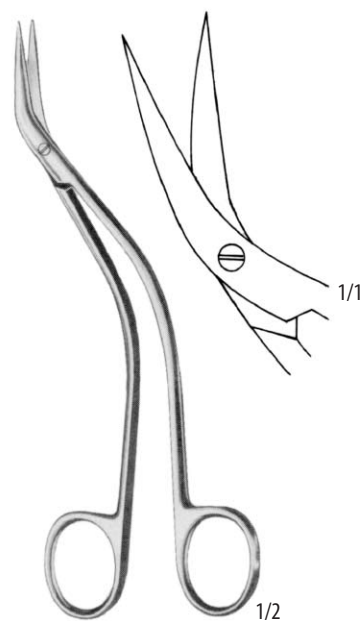
**DE BAKHEY****113 91 0272**

15,5 cm

**POTTS-DE MARTEL****113 91 0273**

21,0 cm



McINDOE
113 91 0290
19,0 cm

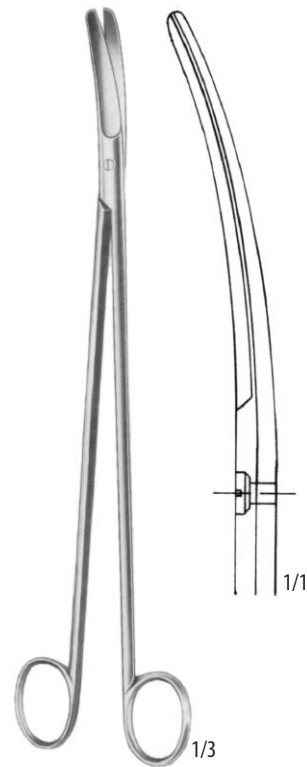

CRAFOORD
113 91 0292
30,0 cm

 NŮŽKY NA STŘEVA, ANATOMICKÉ
ENTERETOMY, DISSECTING SCISSORS

113 01 0520
22,0 cm



113 91 0295
21,0 cm



113 91 0296
21,0 cm



113 91 0297
11,0 cm



113 91 0300
11,0 cm

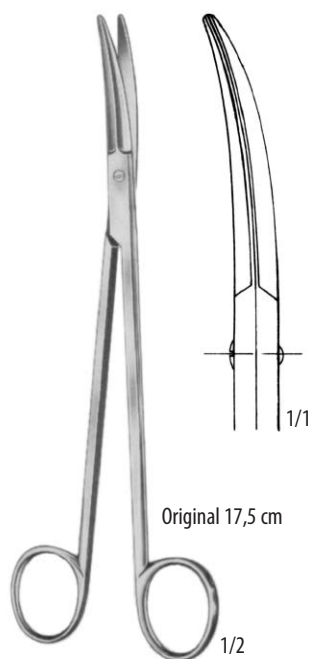

Original 17,5 cm

PRINCE**113 91 0303**

17,5 cm

113 32 0010

18,5 cm

**GOOD****113 91 0305**

19,0 cm

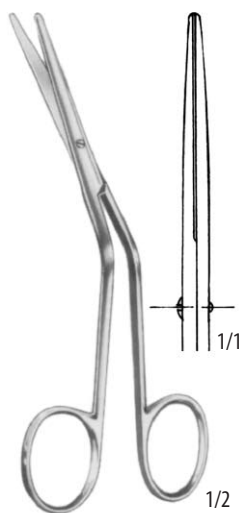
**FOMON****113 91 0311**

13,5 cm

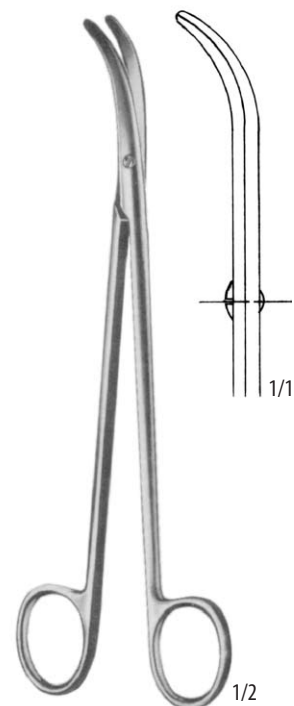
**HALLE****113 91 0312**

19,0 cm

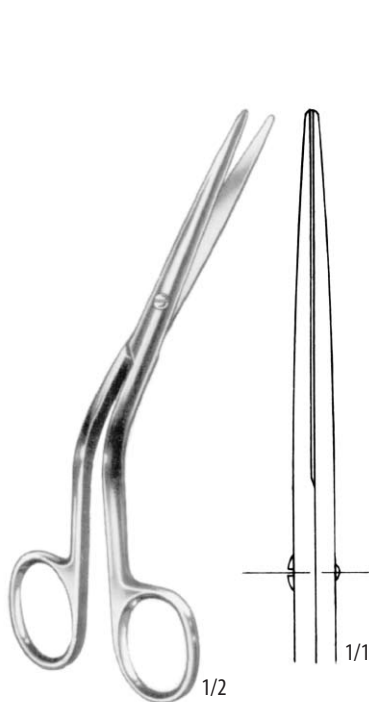
**COTTLE****113 91 0313**

16,0 cm

**HEYMANN****113 30 0010**

18,0 cm

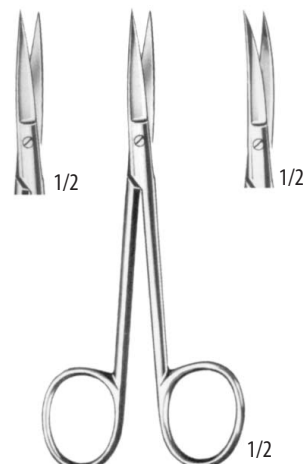
**WAGNER**

rovné – straight

113 91 0328

12,0 cm

zahnuté – curved

113 91 0331

12,0 cm

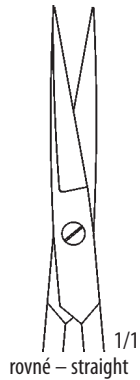

113 38 0010 – 10,0 cm – **113 38 0040**
113 38 0071 – 11,5 cm – **113 38 0091**

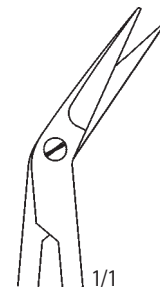
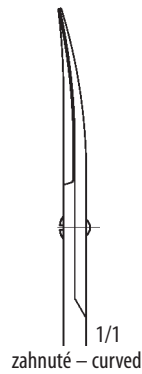

113 38 0210

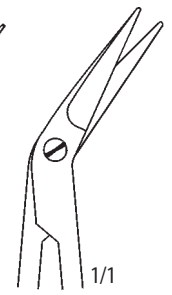

113 38 0260

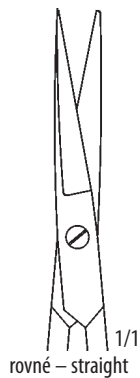

113 38 0020 – 10,0 cm – **113 38 0050**
113 38 0150 – 11,5 cm – **113 38 0100**

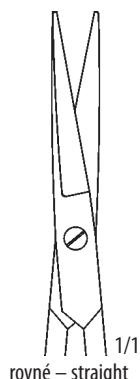
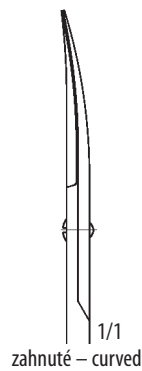

113 38 0030 – 10,0 cm – **113 38 0060**
113 38 0081 – 11,5 cm – **113 38 0161**

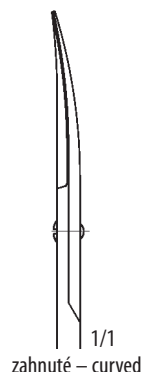

113 38 0311
11,5 cm

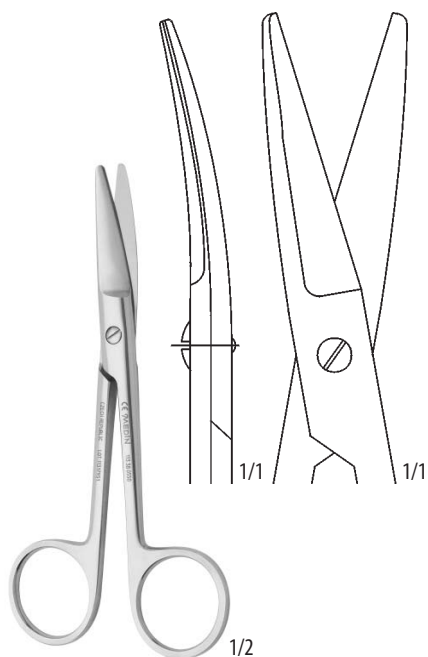

NŮŽKY ENUKLEAČNÍ
ENUCLEATION SCISSORS

113 38 0550

zahnuté – curved

13,0 cm

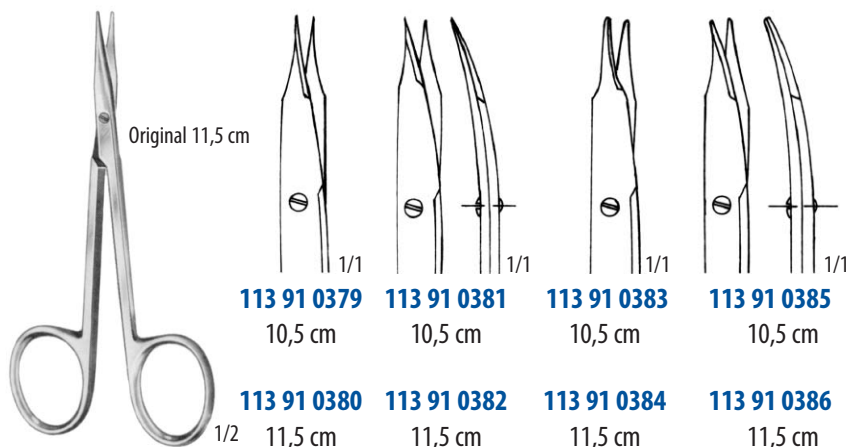

STEVENS

113 91 0379
10,5 cm

113 91 0381
10,5 cm

113 91 0383
10,5 cm

113 91 0385
10,5 cm

113 91 0380
11,5 cm

113 91 0382
11,5 cm

113 91 0384
11,5 cm

113 91 0386
11,5 cm

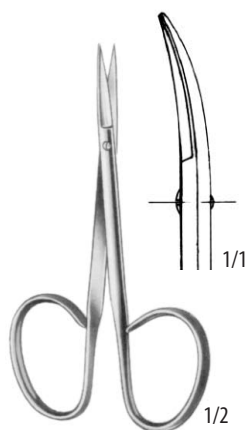

10,0 cm
sharp

113 91 0387 **113 91 0388**
rovné – straight zahnuté – curved

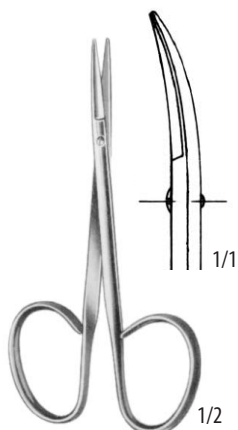

10,0 cm
blunt

113 91 0389 **113 91 0390**
rovné – straight zahnuté – curved

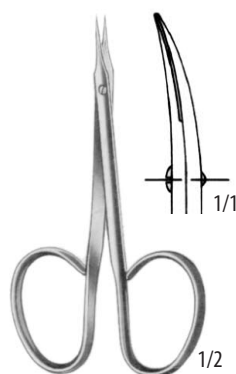

9,5 cm
sharp

113 91 0393 **113 91 0394**
rovné – straight zahnuté – curved

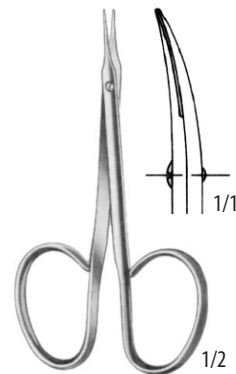

9,5 cm
blunt

113 91 0395 **113 91 0396**
rovné – straight zahnuté – curved

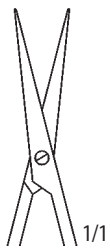

rovné – straight
113 38 0850



13,0 cm



zahnuté – curved
113 38 0860

Original 10,0 mm

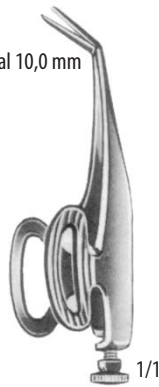

BARRAQUER
5,5 cm

- 113 91 0499** 5,0 mm
- 113 91 0500** 7,0 mm
- 113 91 0501** 10,0 mm

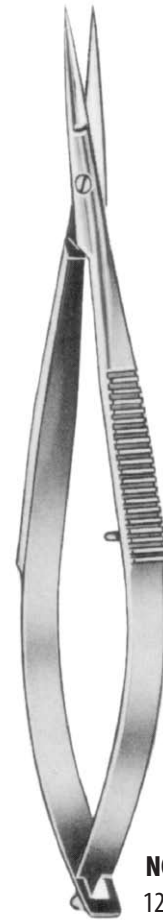

NOYES
12,0 cm



113 91 0490



113 91 0492

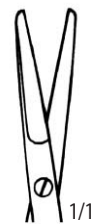

113 91 0494

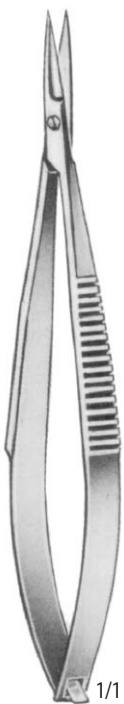

CASTROVIEJO
113 91 0502
9,0 cm



113 91 0503

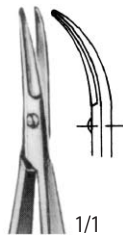

113 38 1020



113 91 0505



113 38 1030

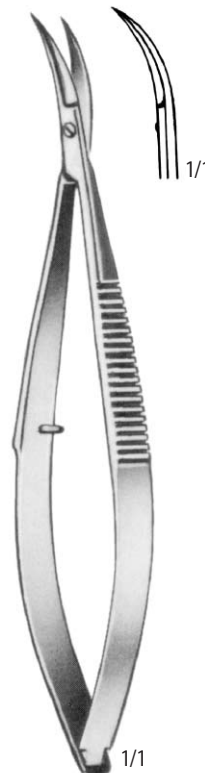

CASTROVIEJO
113 91 0507
10,0 cm

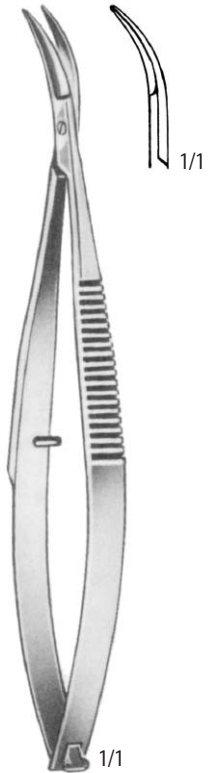

CASTROVIEJO
113 91 0508
10,0 cm



WESTCOTT
113 91 0518
11,0 cm



WESTCOTT
113 91 0517
11,0 cm

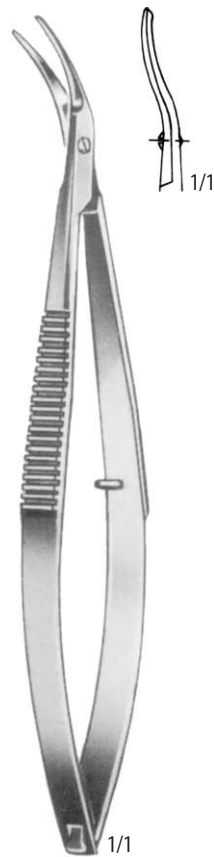

CASTROVIEJO
113 91 0521
11,0 cm

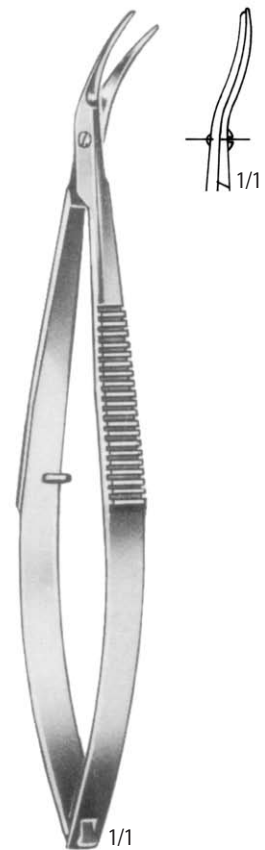

CASTROVIEJO
113 91 0522
11,0 cm



SPENCER

113 91 0399 9,0 cm
113 91 0400 10,5 cm



LITTAUER

113 91 0403 14,0 cm

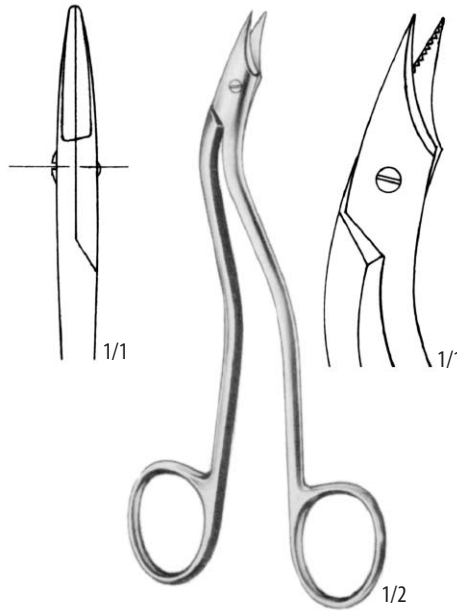

HEATH

113 91 0408 15,0 cm



NORTHBENT

113 91 0411 12,5 cm

MIKRO NŮŽKY
MICRO SCISSORS



18,0 cm



113 91 0573 25°



113 91 0574 45°



113 91 0575 60°



113 91 0576 90°

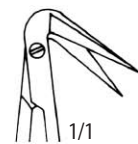

113 91 0577 125°



113 91 0578 25°



113 91 0579 45°

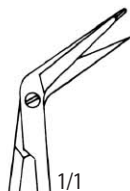

113 91 0580 60°



113 91 0581 90°

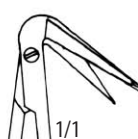

113 91 0582 125°

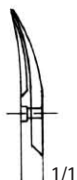

113 91 0537

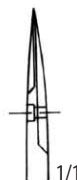

113 91 0539

GOMEL
14,5 cm

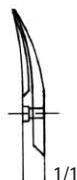

113 91 0538



113 91 0540

GOMEL
18,0 cm

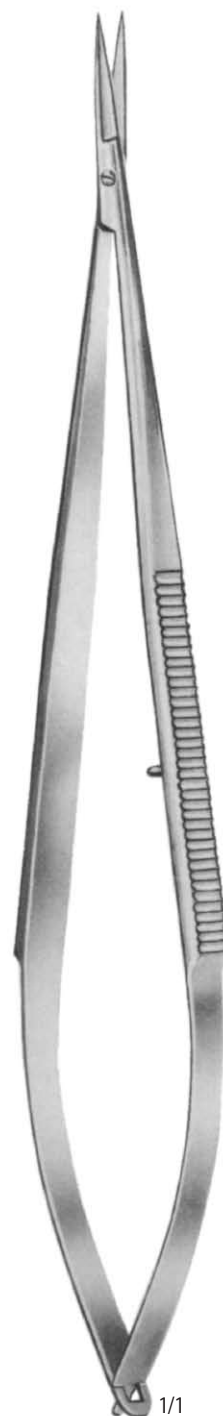

113 91 0552



113 91 0553

18,5 cm



NŮŽKY NA MĚKKÉ OBVAZY
PLASTER SCISSORS
113 05 0210
23,5 cm



NŮŽKY NA VLASY
HAIR SCISSORS
113 08 1000
16,5 cm



sterilizace při
143°C./290° F
autoclavable

UNIVERSAL
113 91 0432
18,0 cm

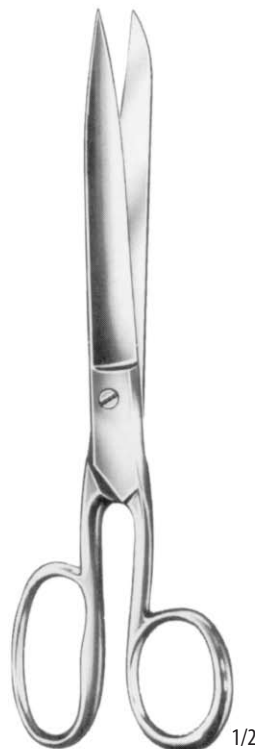

SMITH (MOD. USA)
113 91 0437
20,0 cm



LORENZ
113 91 0439
23,0 cm



Original 16,0 cm

113 91 0444 – 16,0 cm
113 91 0445 – 19,0 cm

1/2

LISTER-EXCENTRIC
se zuby – saw edge



Original 18,0 cm

113 91 0446 – 9,0 cm
113 91 0447 – 11,0 cm
113 91 0448 – 14,0 cm
113 05 0030 – 15,0 cm
113 91 0450 – 18,0 cm
113 05 0040 – 20,0 cm

1/2

LISTER



Original 20,0 cm

113 91 0452 – 20,0 cm
113 91 0453 – 22,0 cm

1/2

ESMARCH



1/2

SEUTIN
113 91 0454
23,0 cm



1/2

113 91 0455
se zuby – saw edge
20,0 cm



1/2

BRUNS
23,0 cm
113 91 0457
hladký – smooth

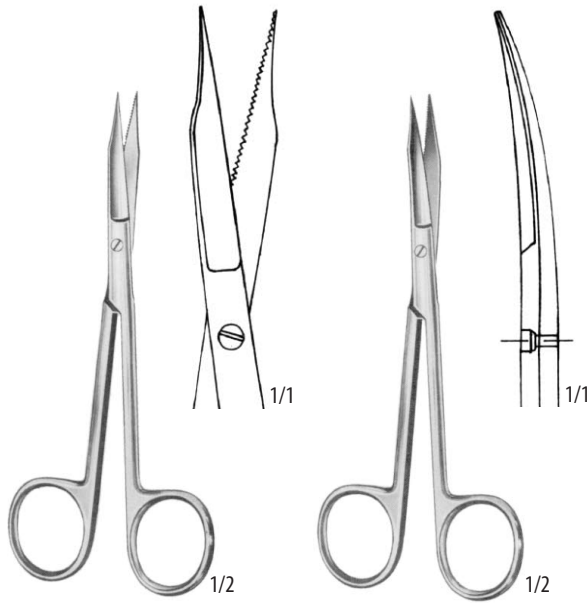

GOLDMANN-FOX

se zuby – saw edge

113 91 0474
rovné – straight

13,0 cm

113 91 0475
zahnuté – curved

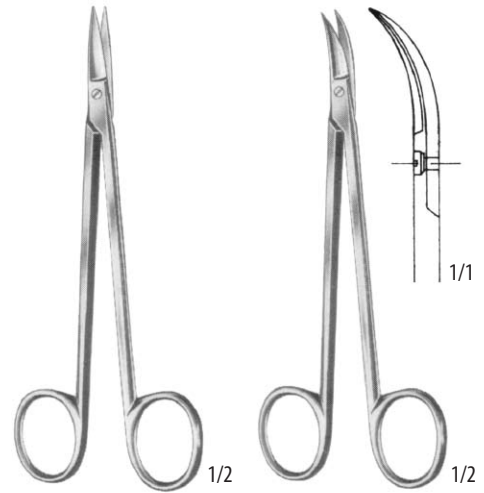

QUINBY

12,0 cm

113 91 0483
rovné – straight

113 91 0484
zahnuté – curved

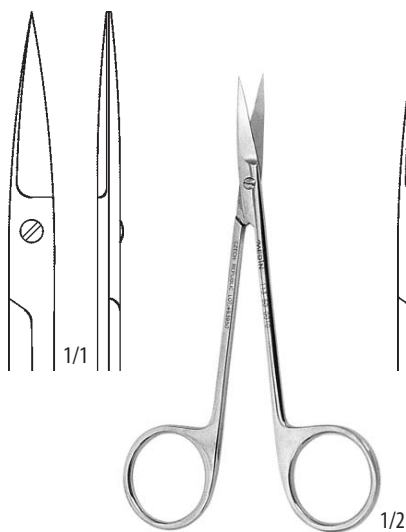

113 50 0010
rovné – straight

12,0 cm

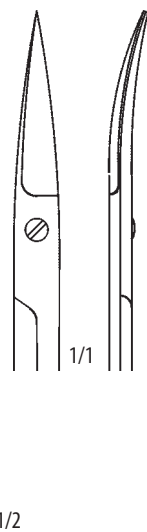

113 50 0020
zahnuté – curved

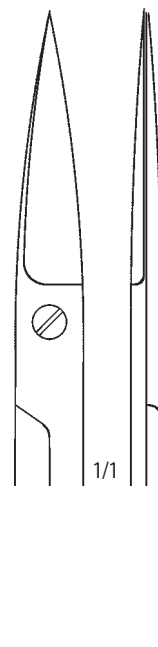

113 50 0030
rovné – straight

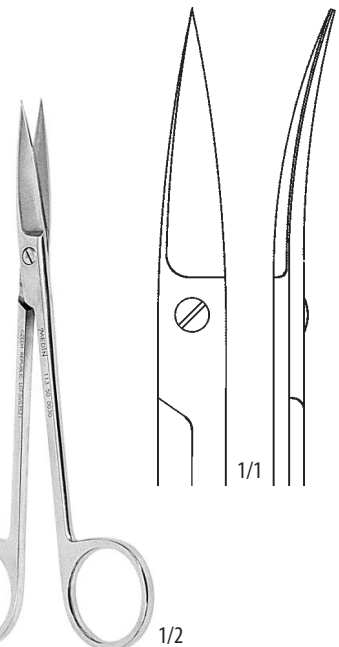

14,5 cm

113 50 0040
zahnuté – curved

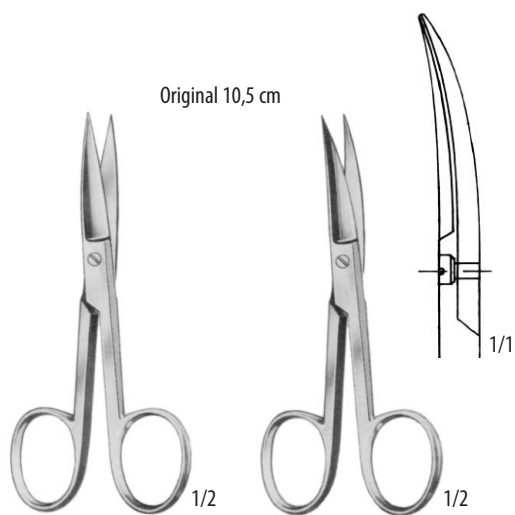

113 91 0458 9,0 cm
113 91 0459 10,5 cm

113 91 0460
113 91 0461

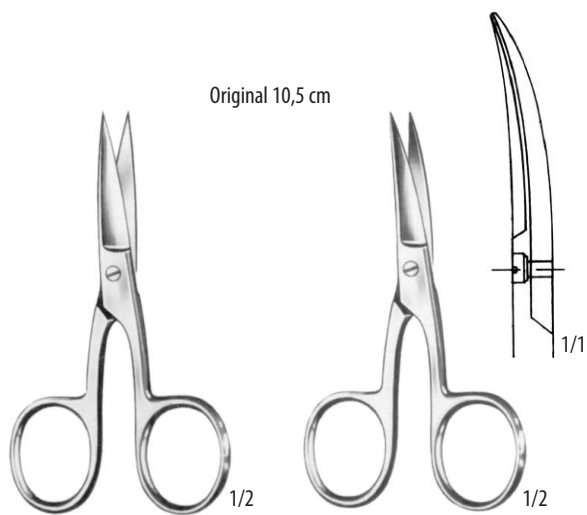

113 91 0462 9,0 cm
113 91 0463 10,5 cm

113 91 0464
113 91 0465

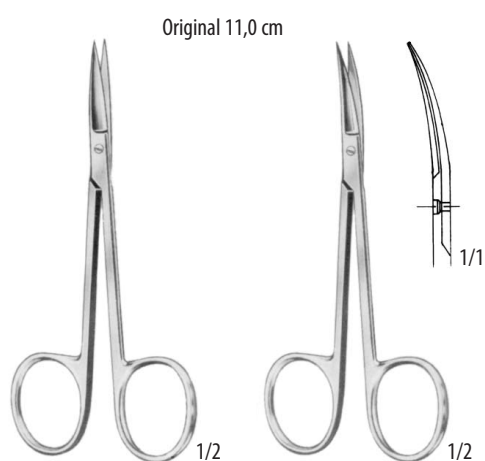

113 91 0466 10,0 cm
113 91 0467 11,0 cm

113 91 0468
113 91 0469



113 91 0470
10,5 cm



KÖNIG
113 91 0472
13,0 cm

113 91 0473
15,0 cm



IRIS
SUPER CUT
10 cm

113 91 0685

rovné hrotnaté – straight sharp

113 91 0686

zahnuté hrotnaté – curved sharp



JABALEY
SUPER CUT
12 cm

113 91 0687

rovné hrotnaté – straight sharp

113 91 0688

zahnuté hrotnaté – curved sharp



STEVENS
SUPER CUT
12,5 cm

113 91 0689

rovné hrotnaté – straight sharp

113 91 0690

zahnuté hrotnaté – curved sharp



LISTER (BANDAGE)

113 91 0691

14 cm



MAYO
SUPER CUT
15 cm

113 91 0692
rovné – straight

113 91 0693
zahnuté – curved

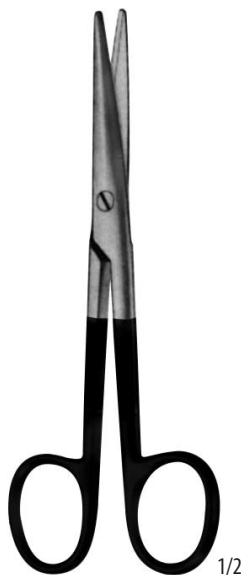

MAYO-STILLE
SUPER CUT

113 91 0694
15 cm
rovné – straight

113 91 0695
17 cm
rovné – straight

113 91 0696
15 cm
zahnuté – curved

113 91 0697
17 cm
zahnuté – curved



MAYO-HARRINGTON
SUPER CUT

113 91 0698
20 cm
rovné – straight

113 91 0699
23 cm
rovné – straight



RANGEL-STILLE
SUPER CUT

113 91 0700
12,5 cm
zahnuté – curved

113 91 0701
15 cm
zahnuté – curved

113 91 0702
18 cm
zahnuté – curved

113 91 0703
20 cm
zahnuté – curved

113 91 0704
23 cm
zahnuté – curved



METZENBAUM
SUPER CUT

113 91 0705

15 cm
rovné – straight

113 91 0706

18 cm
rovné – straight

113 91 0707

20 cm
rovné – straight

113 91 0708

23 cm
rovné – straight

113 91 0709

26 cm
rovné – straight



METZENBAUM
SUPER CUT

113 91 0710

15 cm
zahnuté – curved

113 91 0711

18 cm
zahnuté – curved

113 91 0712

20 cm
zahnuté – curved

113 91 0713

23 cm
zahnuté – curved

113 91 0714

26 cm
zahnuté – curved



BABY METZENBAUM
SUPER CUT

113 91 0715

12,5 cm
rovné – straight

113 91 0716

12,5 cm
zahnuté – curved

**IRIS**

bez tvrdokovu – without TC
11,5 cm

113 91 0717

rovné – straight

113 91 0718

zahnuté – curved

**IRIS**

s tvrdokovem – with TC
11,5 cm

113 91 0719

rovné – straight

113 91 0720

zahnuté – curved

**LA GRANGE**

bez tvrdokovu – without TC
11,5 cm

113 91 0721**LA GRANGE**

s tvrdokovem – with TC
11,5 cm

113 91 0722

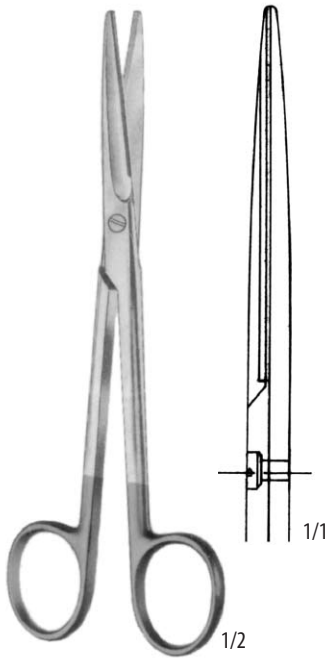

MAYO

113 91 0601
113 91 0602
113 91 0603

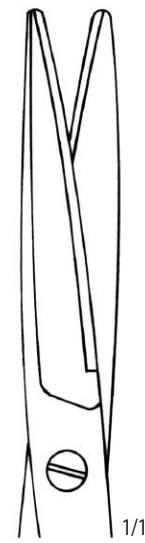

Original 17,0 cm

14,5 cm
17,0 cm
23,0 cm



113 91 0604
113 91 0605
113 91 0606



MAYO



PARAMETRIUM

Original 23,0 cm

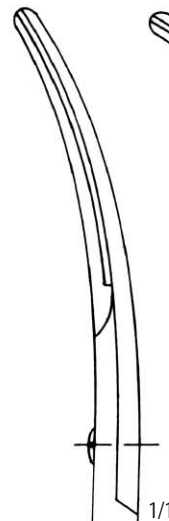
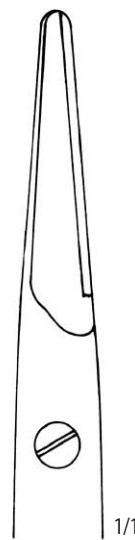

113 91 0607
22,5 cm

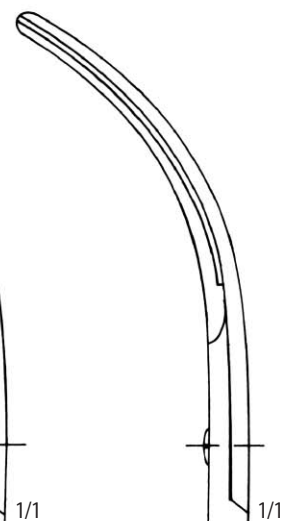

113 91 0608
23,0 cm

NŮŽKY TVRDOKOVOVÉ
SCISSORS WITH TUNGSTEN CARBIDE INSERT



1/2

MAYO-STILLE

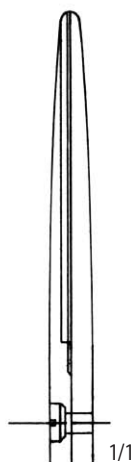

1/1

113 91 0609
113 91 0610

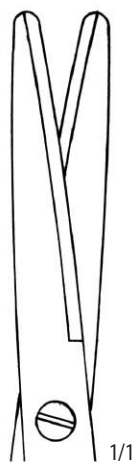

1/1

Original 17,0 cm

15,0 cm
17,0 cm

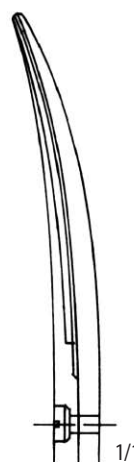

1/1

113 91 0611
113 91 0612



1/2

MAYO-STILLE

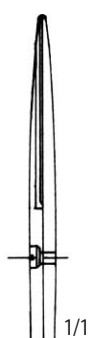

1/1



2/3

113 91 0617

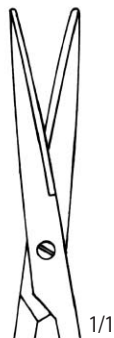

1/1

METZENBAUM

11,5 cm

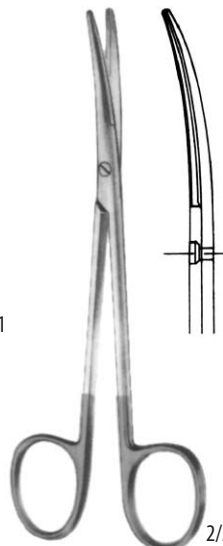

2/3

113 91 0618

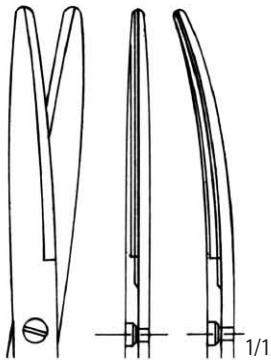

Original 18,0 cm

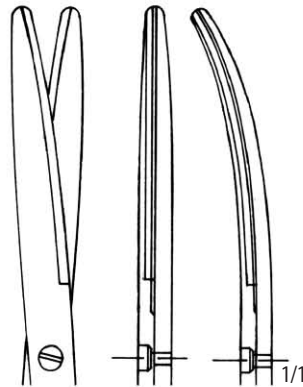

Original 20,0 cm

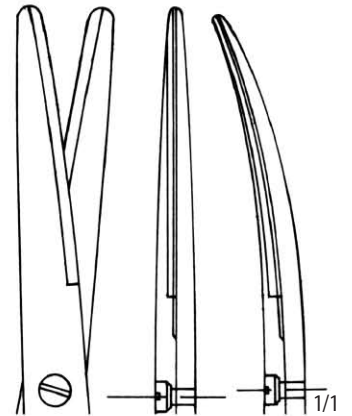

Original 23,0 cm



Original 18,0 cm



METZENBAUM

rovné – straight

113 91 0621

18,0 cm

113 91 0622

20,0 cm

113 91 0623

23,0 cm

113 91 0624

25,0 cm

113 91 0625

28,0 cm

zahnuté – curved

113 91 0627

113 91 0628

113 91 0629

113 91 0630

113 91 0631

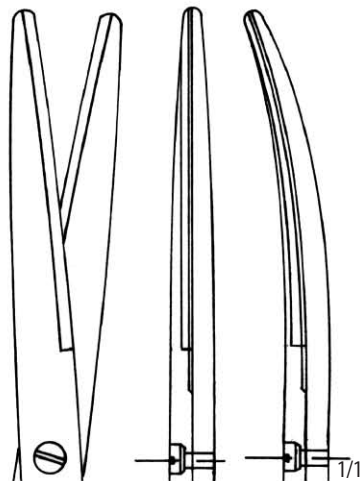

Original 25,0 cm

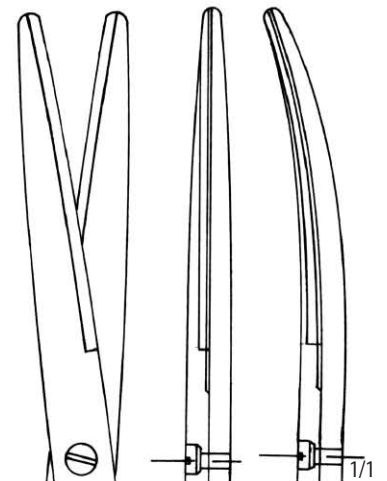

Original 28,0 cm

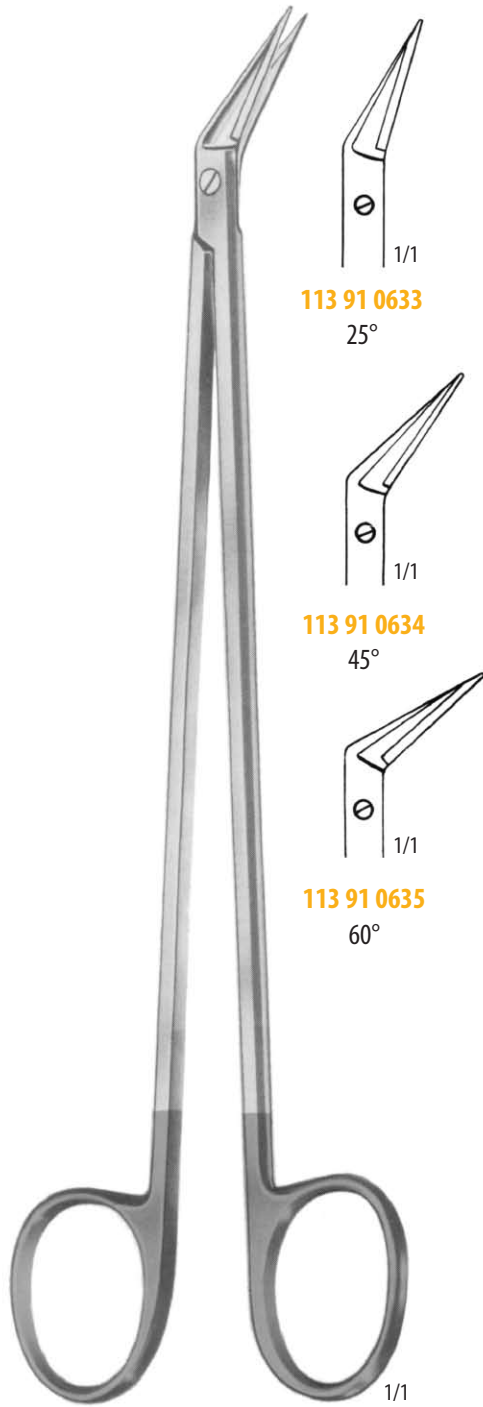

POTTS-SMITH
19,0 cm

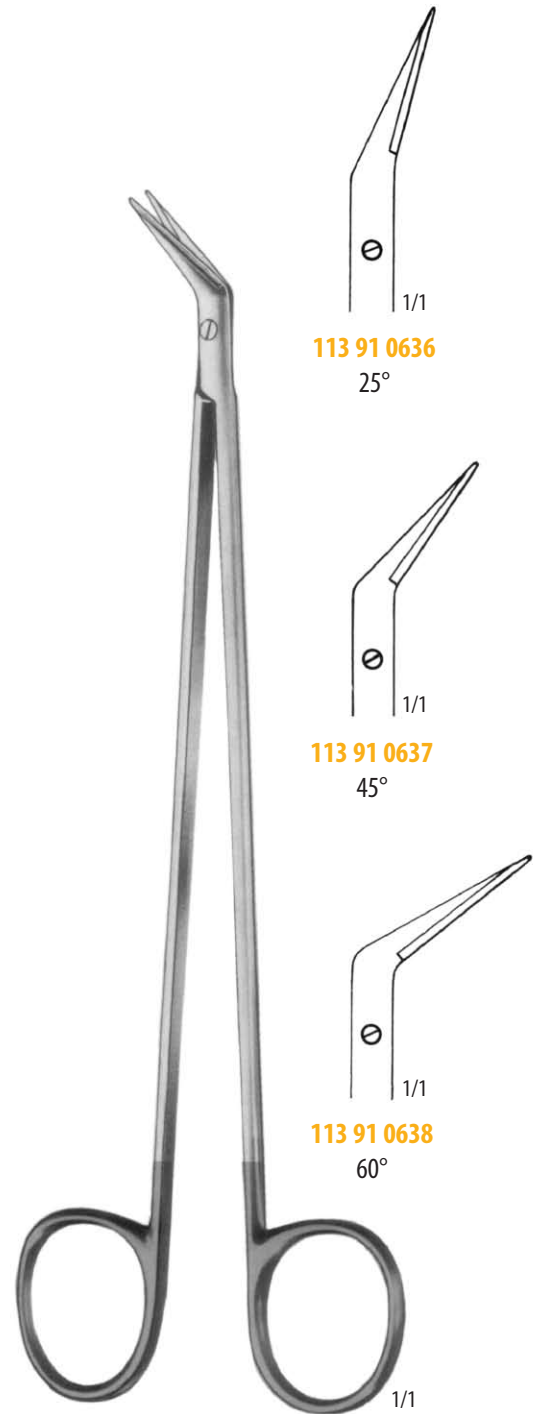

DE BAKY
18,0 cm

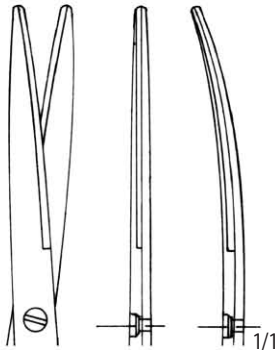

Original 18,0 cm

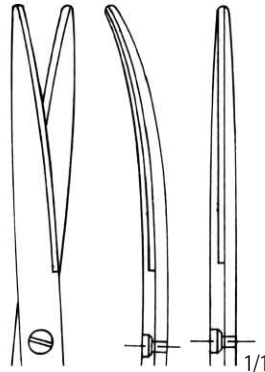

Original 20,0 cm

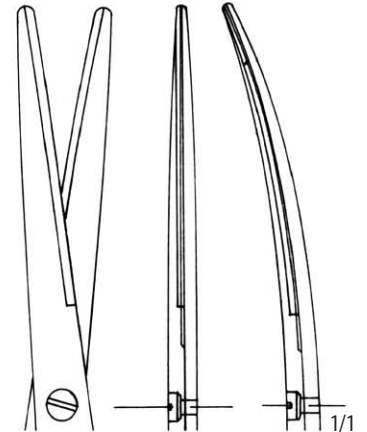

Original 23,0 cm

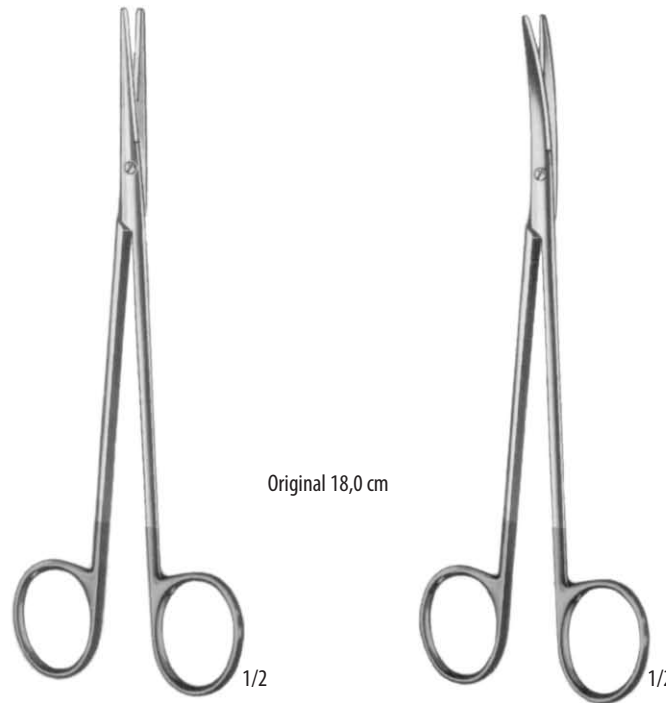

Original 18,0 cm

METZENBAUM – DELICATE

rovné – straight

113 91 0645

18,0 cm

113 91 0646

20,0 cm

113 91 0647

23,0 cm

113 91 0648

25,0 cm

113 91 0649

28,0 cm

zahnuté – curved

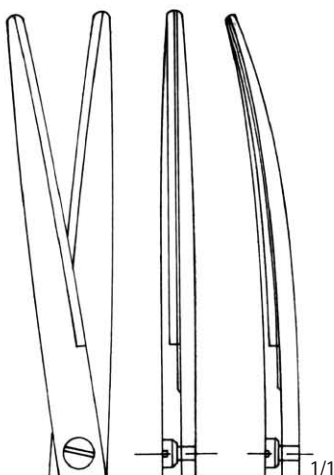
113 91 0650
113 91 0651
113 91 0652
113 91 0653
113 91 0654

Original 25,0 cm

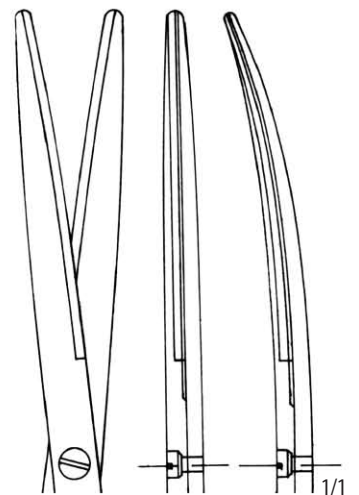

Original 28,0 cm

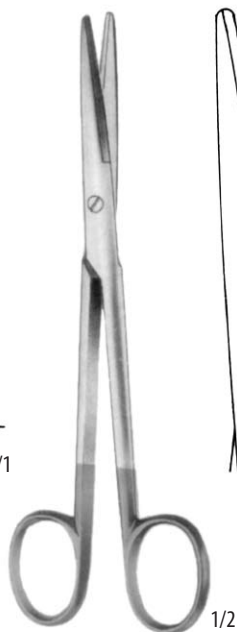
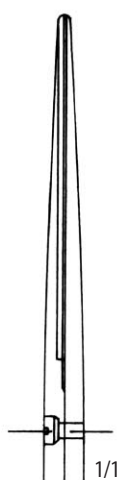
**LEXER****113 91 0639**

16,0 cm

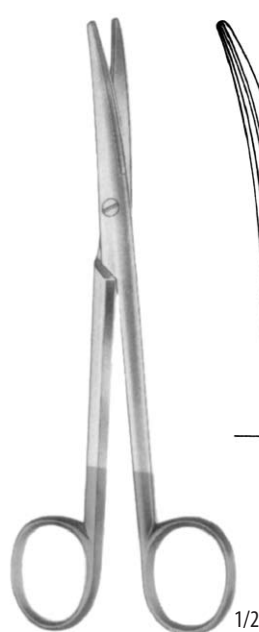
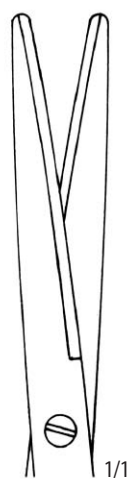
**LEXER****113 91 0640**

16,0 cm

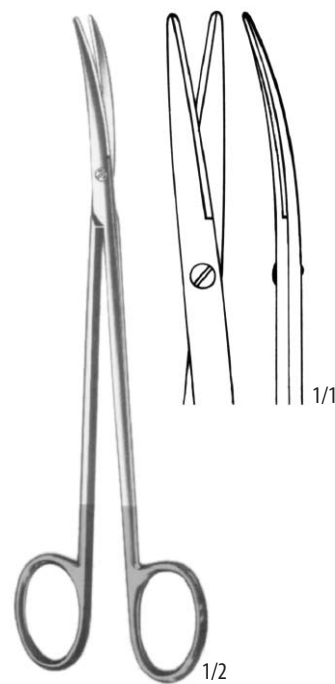
**TOENNIS-ADSON-DELICATE****113 91 0665**

17,5 cm

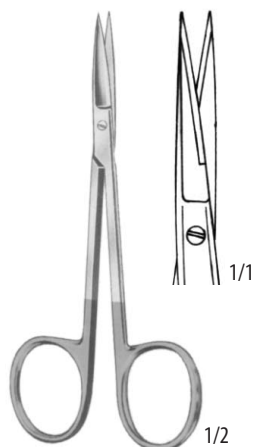
**113 91 0668**

11,5 cm

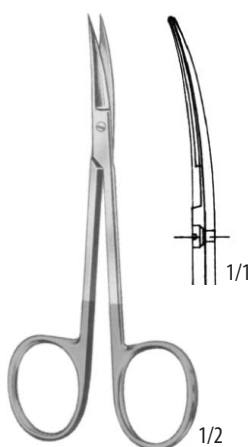
**113 91 0669**

11,5 cm

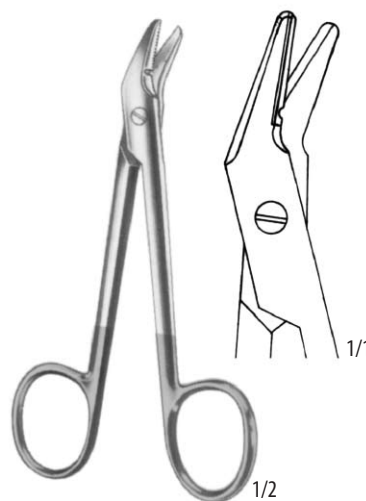
**UNIVERSAL****113 91 0670**

12,0 cm

**LISTER****113 91 0671**

18,0 cm







KUEHNE
114 02 0010
10,5 cm

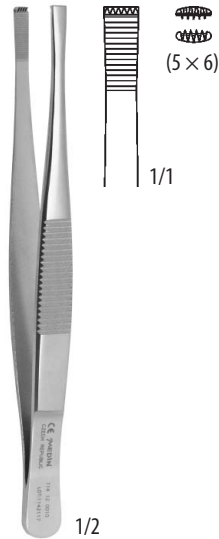

114 12 0010
14,0 cm



114 12 0020
20,0 cm



114 12 0030
10,8 cm

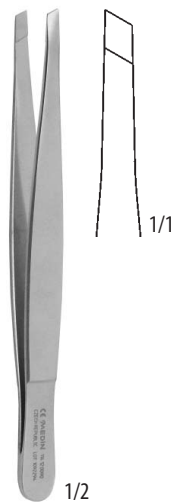

114 12 0090
13,0 cm



114 12 0100
14,3 cm

PINZETY ANATOMICKÉ
DRESSING FORCEPS

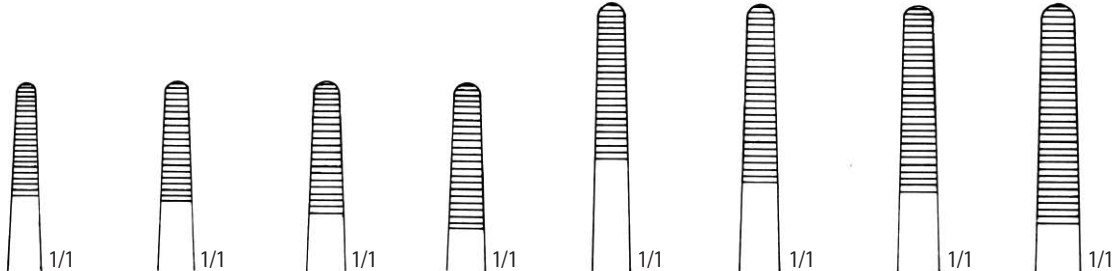

Original 14,5 cm



114 91 0002 114 91 0003 114 91 0004 114 08 0030 114 91 0006 114 08 0040 114 08 0050 114 08 0060

114 91 0002	11,5 cm
114 91 0003	13,0 cm
114 91 0004	14,5 cm
114 08 0030	16,0 cm
114 91 0006	18,0 cm
114 08 0040	20,0 cm
114 08 0050	25,0 cm
114 08 0060	30,0 cm

STANDARD 1/2

PINZETY CHIRURGICKÉ
TISSUE FORCEPS

Original 14,5 cm

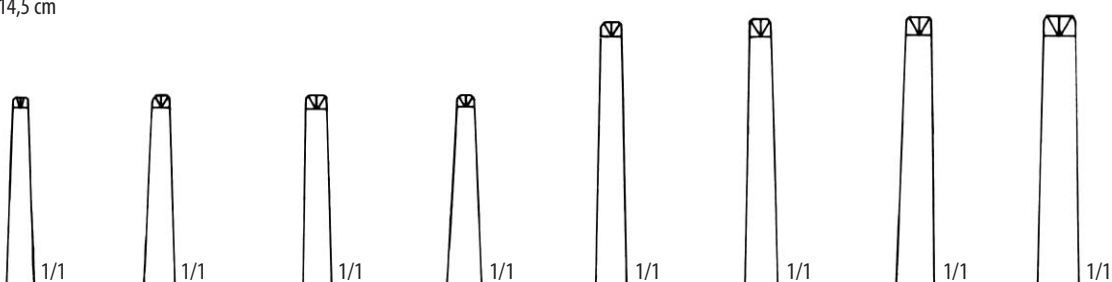
114 91 0011 114 91 0012 114 08 0381 114 08 0430 114 91 0015 114 08 0340 114 08 0350 114 08 0360

114 91 0011	11,5 cm
114 91 0012	13,0 cm
114 08 0381	14,5 cm
114 08 0430	16,0 cm jemná – fine
114 91 0015	18,0 cm
114 08 0340	20,0 cm
114 08 0350	25,0 cm
114 08 0360	30,0 cm

STANDARD 1/2



114 91 0019 13,0 cm
 114 91 0020 14,5 cm
 114 91 0021 16,0 cm
 114 91 0022 18,0 cm
 114 91 0023 20,0 cm
 114 91 0024 25,0 cm

114 91 0026 13,0 cm
 114 91 0027 14,5 cm
 114 91 0028 16,0 cm



114 91 0029 13,0 cm
 114 91 0030 14,5 cm
 114 91 0031 16,0 cm

114 91 0033 11,5 cm
 114 91 0034 13,0 cm
 114 08 0101 14,5 cm jemná – fine
 114 91 0036 16,0 cm
 114 91 0037 18,0 cm
 114 91 0038 20,0 cm
 114 91 0039 25,0 cm
 114 91 0040 30,0 cm



114 08 0090
14,5 cm



114 08 0231
velmi jemná – very fine
14,5 cm



114 08 0140
jemná – fine
20,0 cm



114 08 0240
velmi jemná – very fine
20,0 cm



114 08 0250
24,5 cm

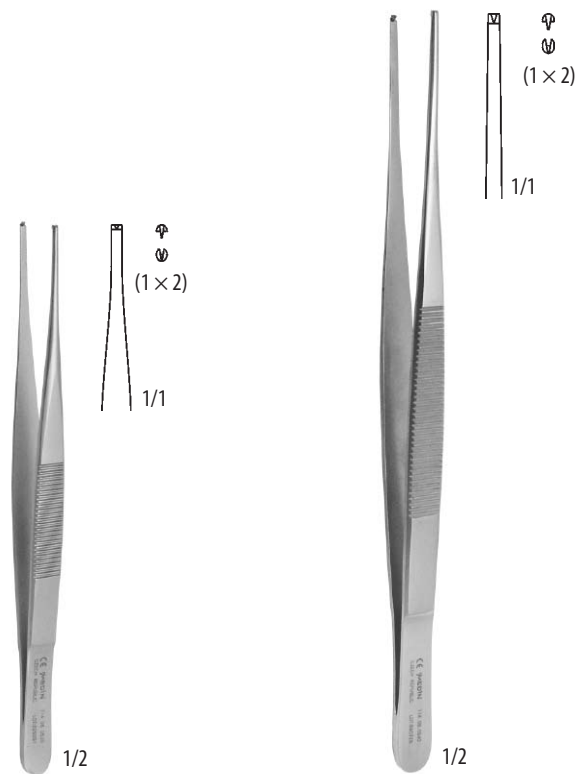

114 08 0530
 velmi jemná – very fine
 14,5 cm

114 08 0540
 20,2 cm

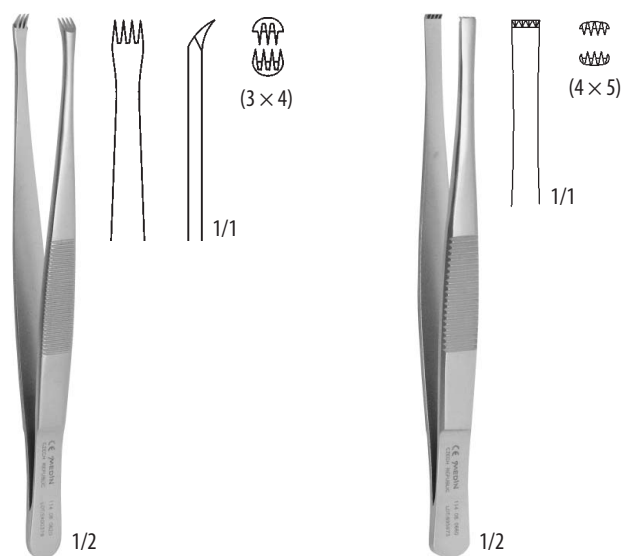

114 08 0620
 14,0 cm

114 08 0660
 14,0 cm

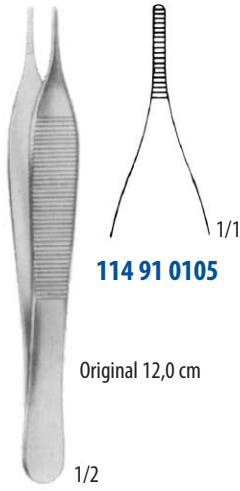

114 91 0105

Original 12,0 cm

1/2

ADSON

- 114 91 0105** 12,0 cm
- 114 91 0107** 15,0 cm

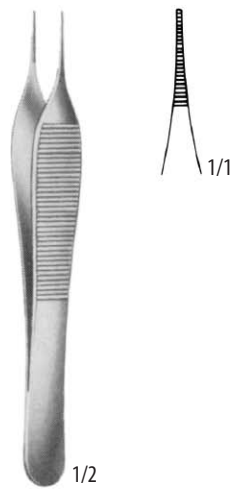

MICRO-ADSON

- 114 91 0108** 12,0 cm

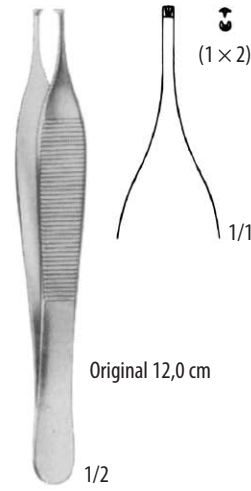

ADSON

- 114 91 0111** 12,0 cm
- 114 91 0113** 15,0 cm

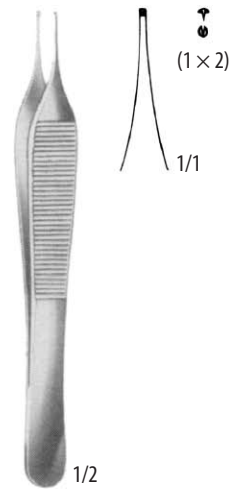

MICRO-ADSON

- 114 91 0114** 12,0 cm



- 114 08 1350** 14,5 cm



- ADSON-BROWN**
- 114 91 0119** 12,0 cm



- McINDOE**
- 114 91 0126** 15,0 cm

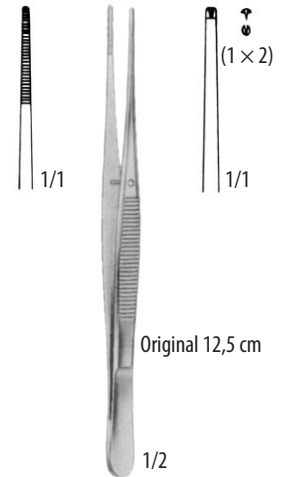

- SEMKEN**
- 114 91 0128** 12,5 cm
- 114 91 0129** 15,5 cm
- 114 91 0132**
- 114 91 0133**



CUSHING
114 91 0152
17,5 cm



CUSHING
114 91 0154
17,5 cm



TAYLOR
114 91 0138
17,5 cm



TAYLOR
114 91 0139
17,5 cm



TAYLOR
114 91 0142
17,5 cm



TAYLOR
114 91 0143
17,5 cm

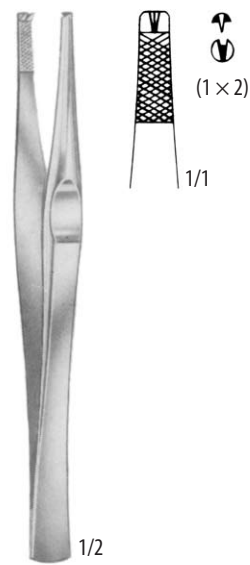

LANE
114 91 0144
14,5 cm

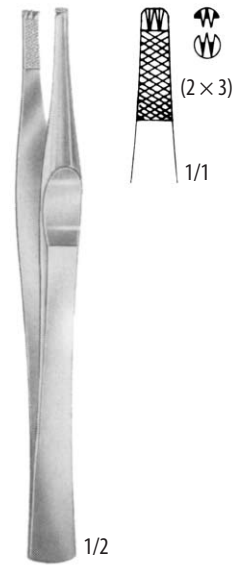

LANE
114 91 0146
14,5 cm

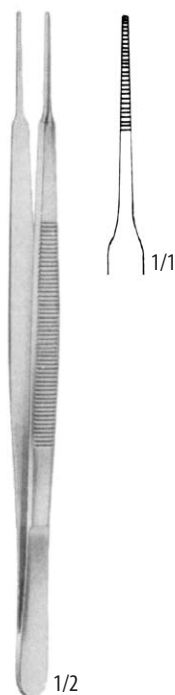

GERALD
114 91 0148
18,0 cm

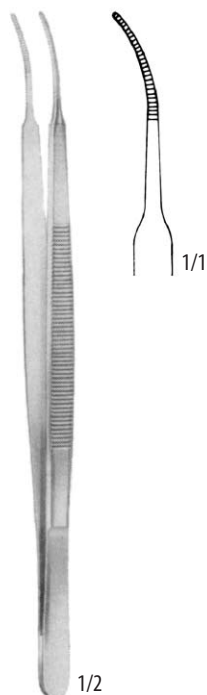

GERALD
114 91 0149
18,0 cm

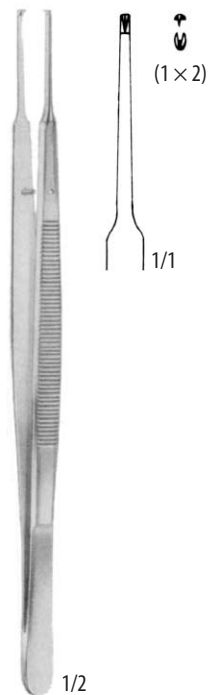

GERALD
114 91 0150
18,0 cm

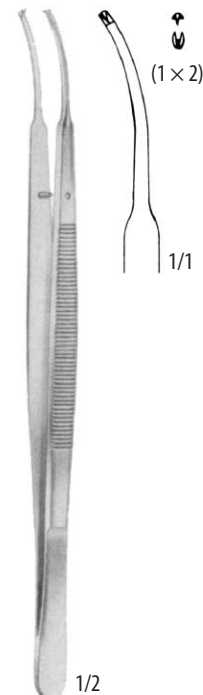

GERALD
114 91 0151
18,0 cm



POTTS-SMITH
114 91 0156 18,0 cm
114 91 0157 21,0 cm
114 91 0158 25,0 cm



POTTS-SMITH
114 91 0162 18,0 cm
114 91 0163 21,0 cm
114 91 0164 25,0 cm

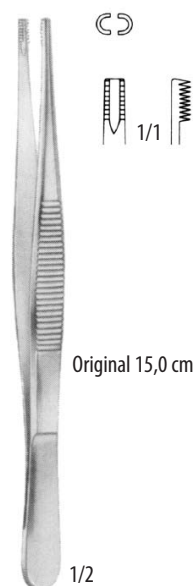

BROWN
114 91 0172 15,0 cm
114 91 0173 20,0 cm
114 91 0174 25,0 cm



WANGENSTEEN
114 91 0179
23,0 cm



STILLE-BARRAYA
114 91 0180 18,0 cm
114 91 0181 20,0 cm
114 91 0182 25,0 cm



COLLIN-DUVAL
114 91 0193
20,0 cm

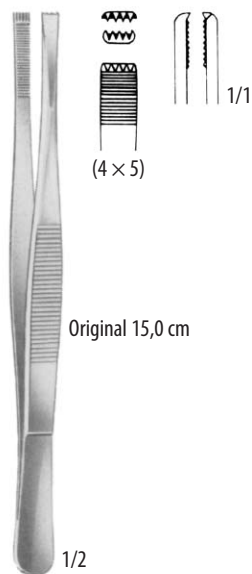

ADLERKREUTZ
114 91 0190 15,0 cm
114 91 0191 20,0 cm

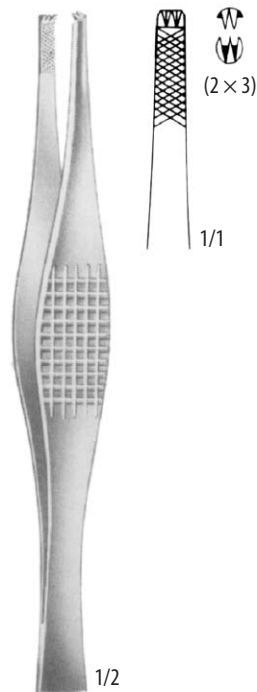

FERRIS-SMITH
114 91 0183
18,0 cm



SINGLEY-TUTTLE
114 91 0198
23,0 cm



NELSON
114 91 0199
23,0 cm



GILLIES
114 91 0200
15,0 cm



RUSS. MODELL
114 91 0208 15,0 cm
114 91 0209 20,0 cm
114 91 0210 25,0 cm

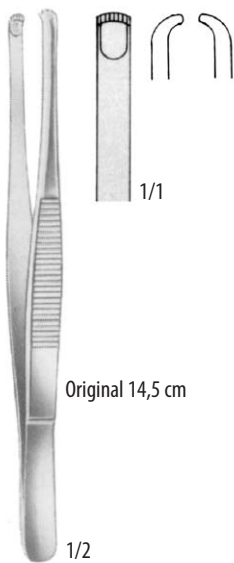

DURANTE
114 91 0211 14,5 cm
114 91 0212 16,0 cm
114 91 0213 20,0 cm

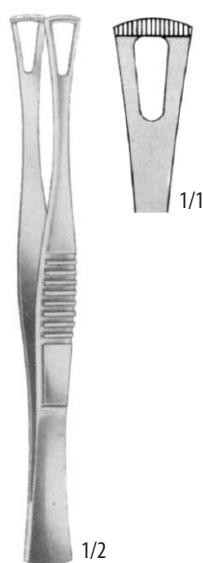

DUVAL
114 91 0214
14,5 cm

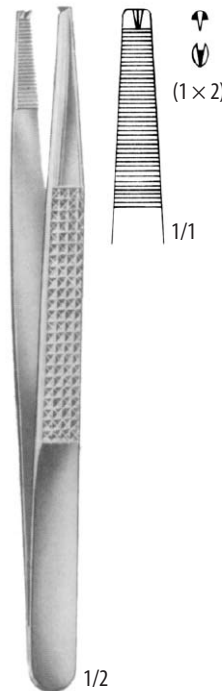

BONNEY
114 91 0215
18,0 cm

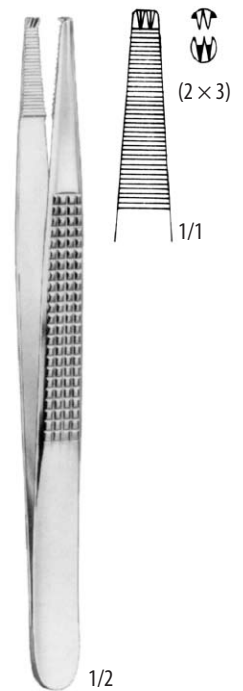

BONNEY
114 91 0216
18,0 cm



114 91 0228
 ø 3,0 mm

114 91 0229
 ø 5,0 mm

114 91 0230
 ø 3,0 mm

114 91 0231
 ø 5,0 mm

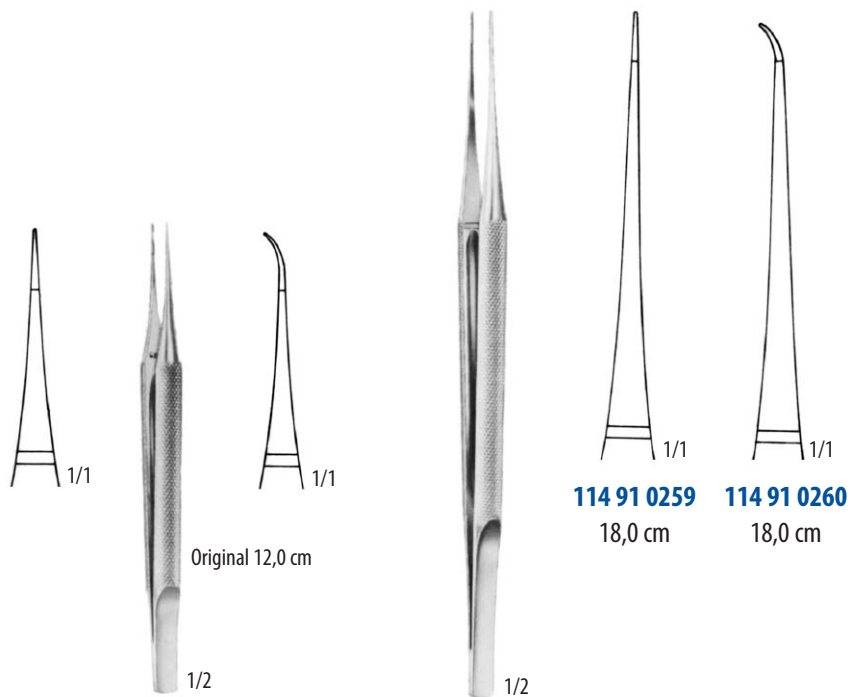
1/2

YASARGIL
 22,0 cm

1/1

1/1

1/1

1/1

Original 12,0 cm

1/2

1/2

114 91 0259
 18,0 cm

114 91 0260
 18,0 cm

114 91 0255 12,0 cm
114 91 0256 15,0 cm

114 91 0257
114 91 0258

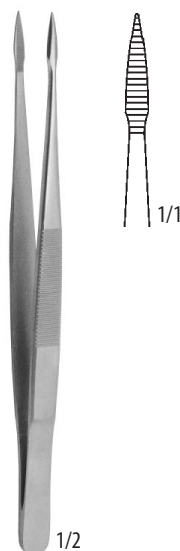
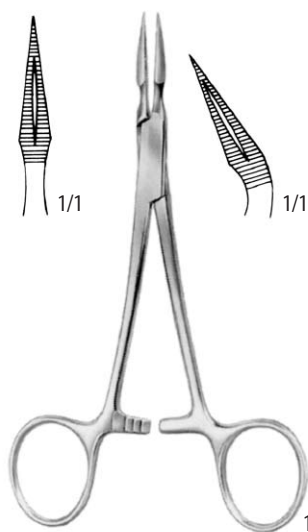
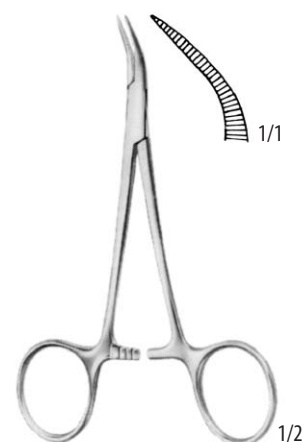
PINZETY NA TRÍŠKY
SPLINTER FORCEPS

114 08 0980
 14,0 cm

STIEGLITZ
114 91 0318 13,5 cm **114 91 0319**

PEET
114 91 0323
 11,5 cm

PINZETY TECHNICKÉ
TECHNICAL FORCEPS

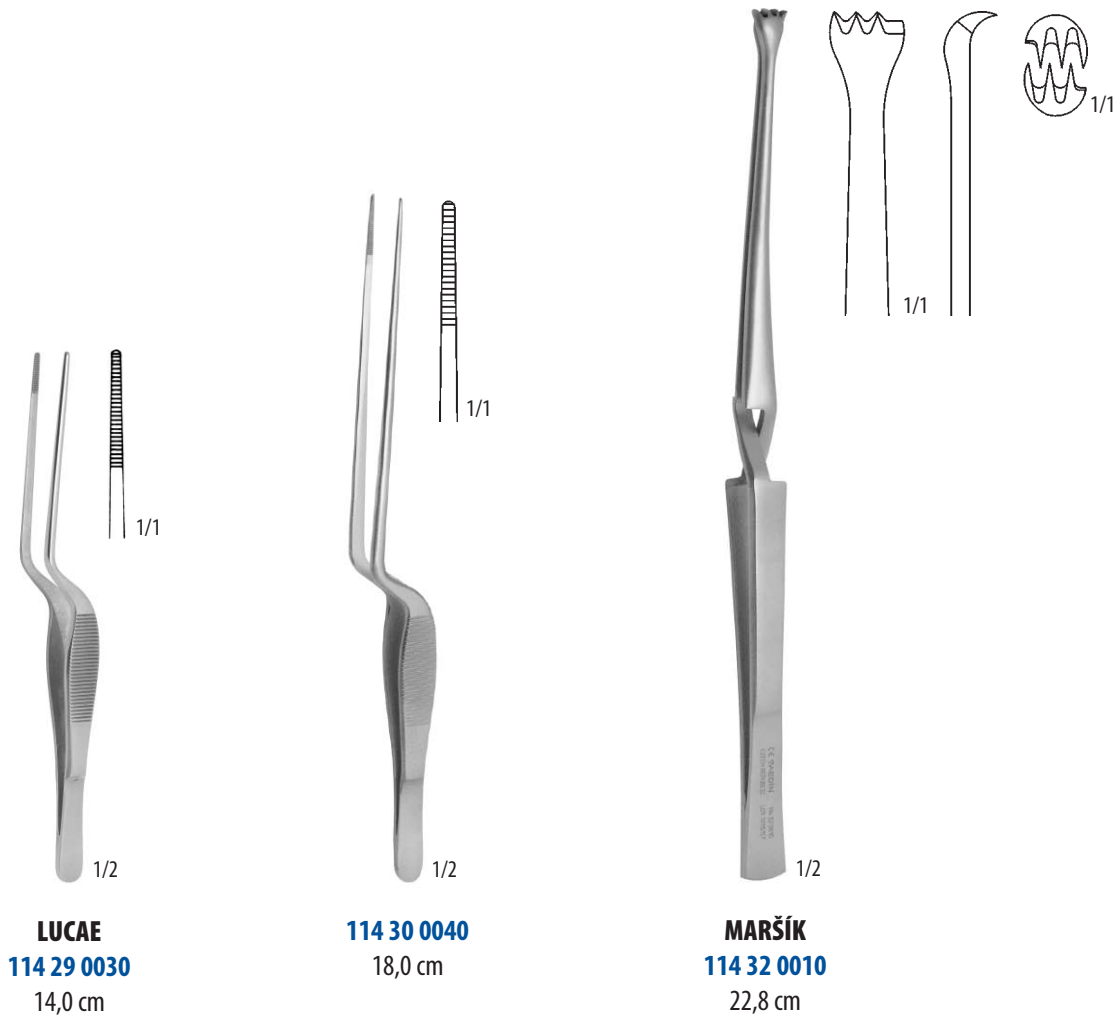
114 08 1020
 13,5 cm

114 08 1030
 19,0 cm

114 08 1040
 24,0 cm



PINZETY OČNÍ
EYE FORCEPS



GRAEFE
10,5 cm

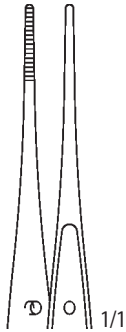

1,0 mm

114 38 0010

114 38 0030
nemagnetická
non magnetic

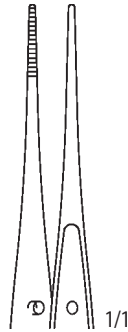

0,8 mm

114 38 0020
jemná – fine

114 38 0040
jemná, nemagnetická
fine, non magnetic

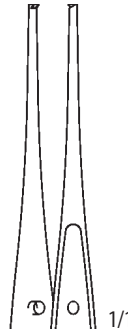

1,0 mm

114 38 0150

114 38 0170
nemagnetická
non magnetic

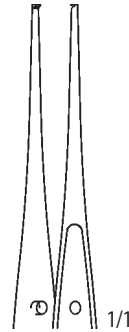

0,8 mm

114 38 0160
jemná – fine

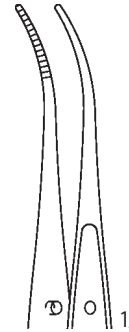

0,8 mm

114 38 0100
jemná – fine

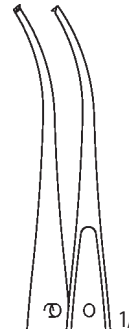

0,8 mm

114 38 0200
jemná – fine



GRAEFE
10,0 cm

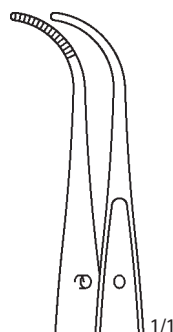

1,0 mm

114 38 0110

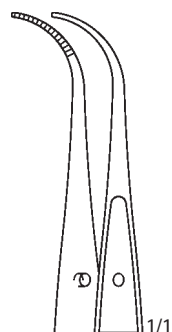

1,0 mm

114 38 0120
nemagnetická
non magnetic

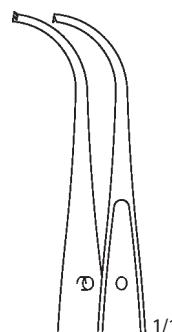

1,0 mm

114 38 0210
nemagnetická
non magnetic

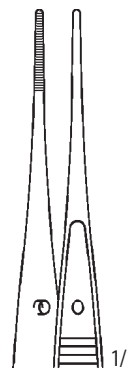

1,2 mm

114 91 0366

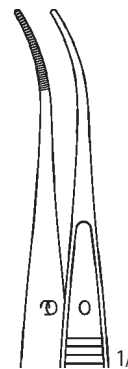

1,2 mm

114 91 0368

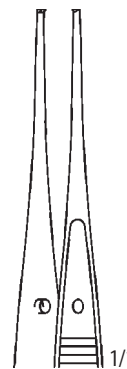

1,2 mm

114 91 0372

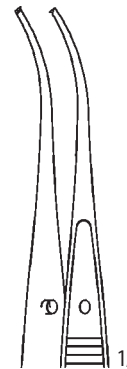

1,2 mm

114 91 0374



GRAEFE
10,0 cm



GRAEFE
114 38 0350
 11,0 cm



GRAEFE
114 38 0360
 11,0 cm



ELSCHNIG
114 38 0370
 10,5 cm

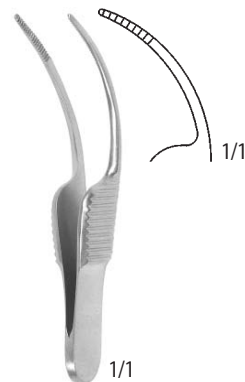

PINZETA NA DUHOVKU
IRIS FORCEPS
114 38 0250
 anatomická – tissue
 4,8 cm

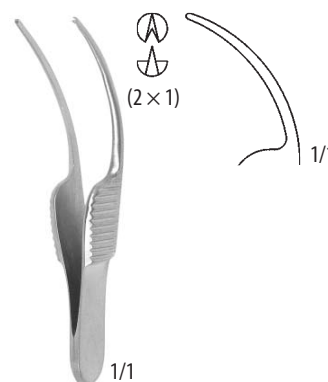

PINZETA NA DUHOVKU
IRIS FORCEPS
114 38 0270
 chirurgická – dressing
 4,8 cm



KOUTNÝ
114 38 0230
 10,0 cm



KUHNT
114 38 0590
10,2 cm

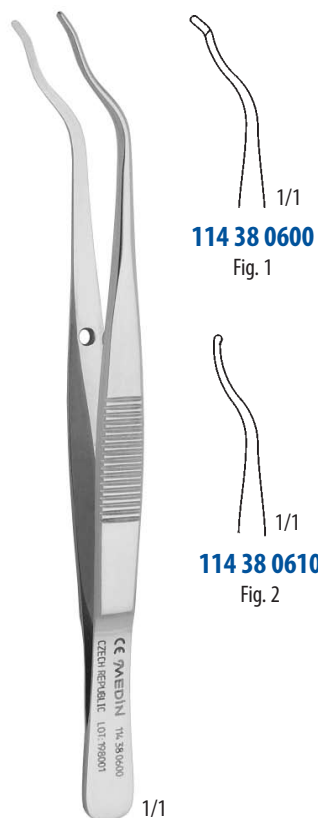

ELSCHNIG
10,7 cm



114 38 0610
Fig. 2



ARRUGA
114 38 0620
10,8 cm



KALT
114 38 0630
10,2 cm



BONEFONT
114 38 0640
10,7 cm



VERHOFF
114 38 0650
10,6 cm

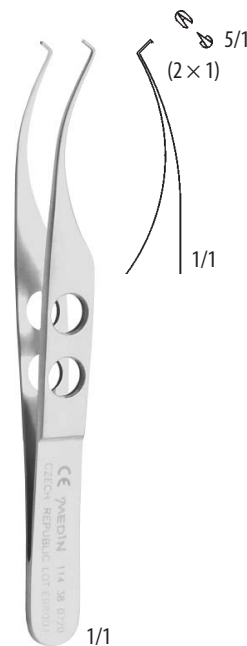

KOLIBRI
114 38 0720
8,0 cm



PINZETA ENUKLEAČNÍ
ENUCLEATION FORCEPS
114 38 0750
14,0 cm



114 38 0810
pravá – right

114 38 0820
levá – left

PINZETA NA OPERACI ŠILHÁNÍ
STRABISMUS FORCEPS
se zámkem – with lock
9,5 cm

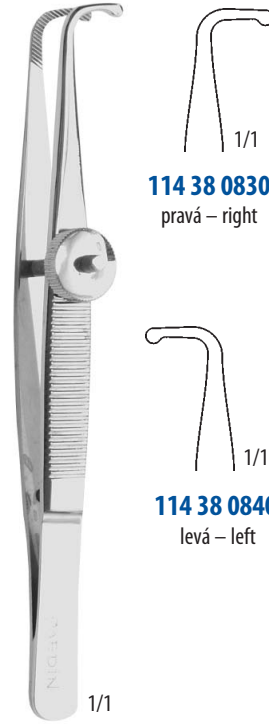

114 38 0830
pravá – right

114 38 0840
levá – left

BLASCOVICS
se šroubem – with screw
9,5 cm

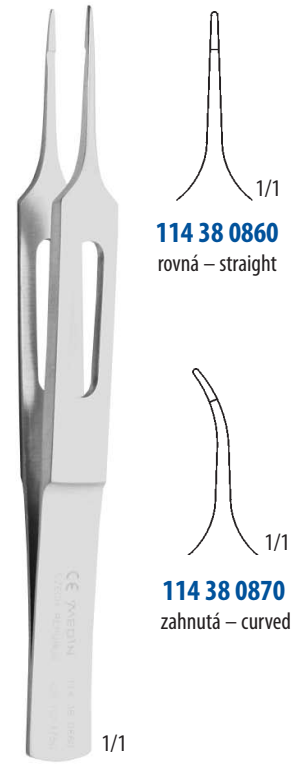

114 38 0860
rovná – straight

114 38 0870
zahnutá – curved

PINZETA NA ROHOVKU
CORNEAL SUTURING FORCEPS
10,0 cm



CASTROVIEJO
114 38 0850
10,0 cm



DESMARRES



114 38 0910
Fig. 1
8,8 cm

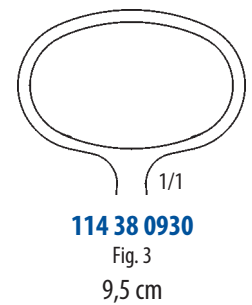

114 38 0930
Fig. 3
9,5 cm



114 38 0920
Fig. 2
9,2 cm

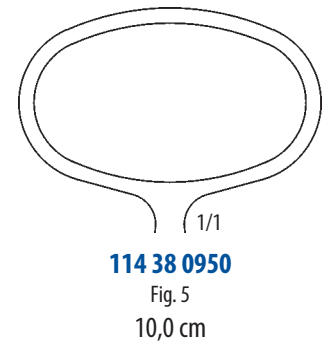

114 38 0950
Fig. 5
10,0 cm

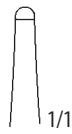

114 38 1110



114 38 1120

1/1

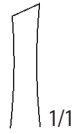
BEER
8,5 cm

1/1

1/1

PINZETA NA ŘASY
CILIA FORCEPS
114 38 1170
8,7 cm

2/1



2/1

1/1

PINZETA NA KERATOPLASTIKU
KERATOPLASTIC FORCEPS
114 38 1230
8,5 cm

1/1

1/1

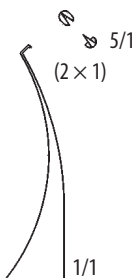
KALT
114 38 1260
9,5 cm

 5/1
(2 × 1)

1/1

1/1

KOLIBRI
114 38 1300
8,0 cm

1/1

1/1

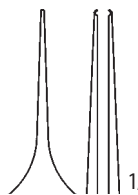
PINZETA ŠICÍ
SUTURING FORCEPS
114 38 1310
hladká – smooth
8,5 cm

1/1

1/1

PINZETA ŠICÍ
SUTURING FORCEPS
114 38 1320
háčková – hooked
8,5 cm

2/1



2/1

1/1

1/1

PINZETA ŠICÍ
SUTURING FORCEPS
114 38 1330
8,2 cm

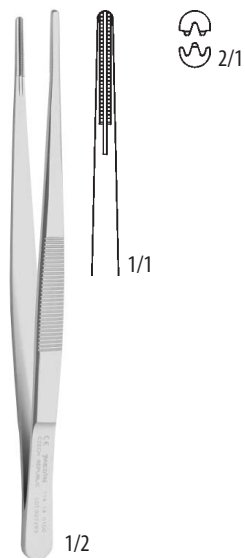
PINZETY ATRAUMATICKÉ
NON-TRAUMATIC VASCULAR TISSUE FORCEPS

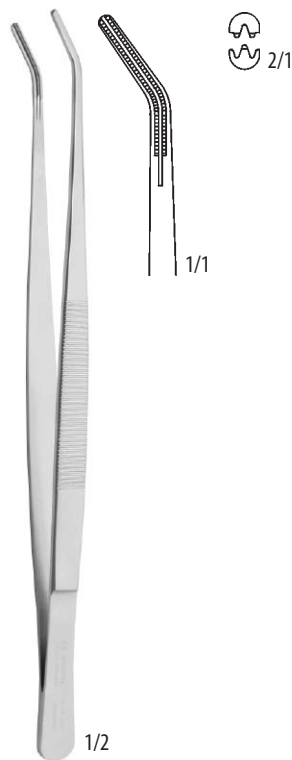
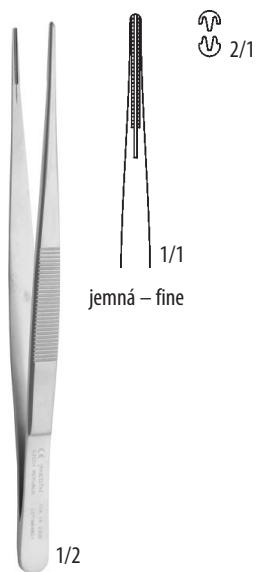
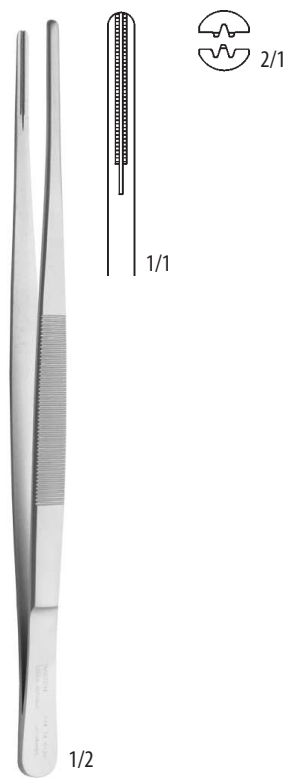
114 14 0100
 14,5 cm

114 14 0110
 20,0 cm

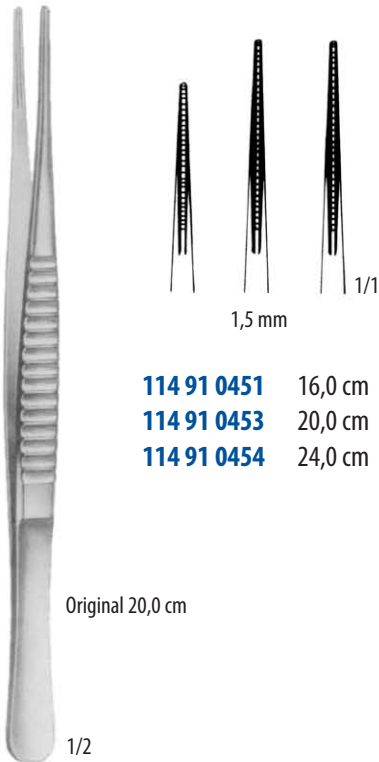
114 14 0120
 19,8 cm

114 14 0300
 14,5 cm

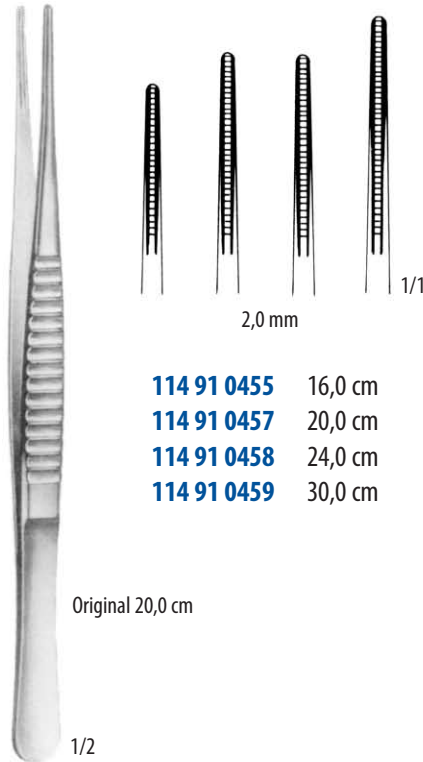
114 14 0130
 20,0 cm

114 14 0140
 24,8 cm



114 91 0451 16,0 cm
114 91 0453 20,0 cm
114 91 0454 24,0 cm

DE BAKEY

114 91 0455 16,0 cm
114 91 0457 20,0 cm
114 91 0458 24,0 cm
114 91 0459 30,0 cm

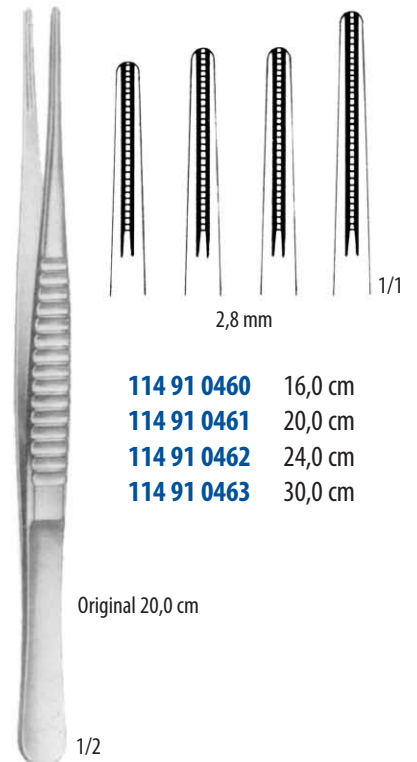
DE BAKEY

114 91 0460 16,0 cm
114 91 0461 20,0 cm
114 91 0462 24,0 cm
114 91 0463 30,0 cm

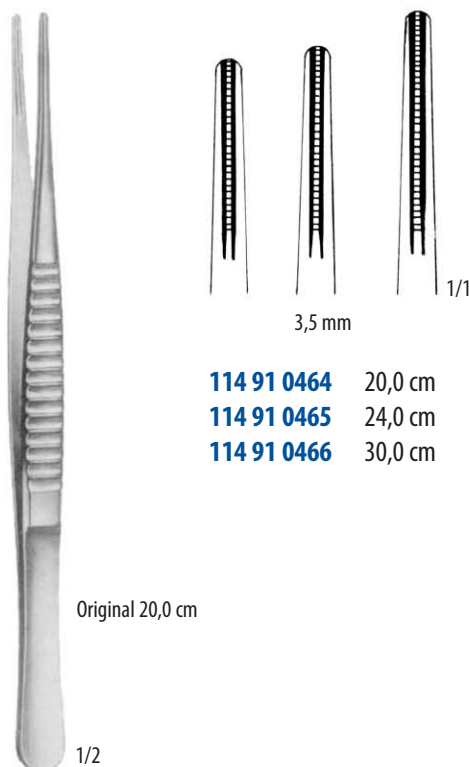
DE BAKEY

114 91 0464 20,0 cm
114 91 0465 24,0 cm
114 91 0466 30,0 cm

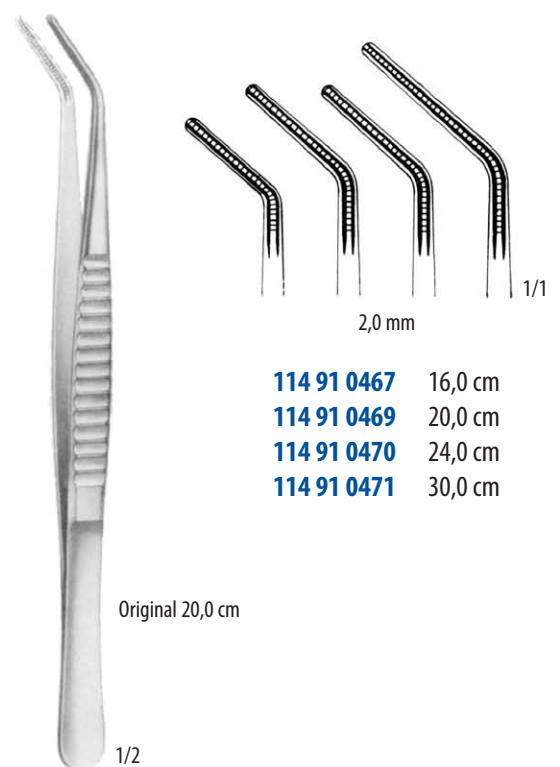
DE BAKEY

114 91 0467 16,0 cm
114 91 0469 20,0 cm
114 91 0470 24,0 cm
114 91 0471 30,0 cm

DE BAKEY

PINZETY BIPOLÁRNÍ
BIPOLAR FORCEPS



1/2

bajonetová – bay-shaped

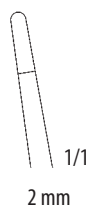
114 08 1470
 22,5 cm

114 08 1480
 22,5 cm

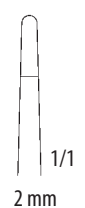
114 08 1490
 22,5 cm

1/2

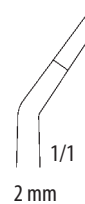
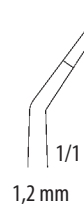
114 08 1500
 19,5 cm

114 08 1510
 19,5 cm

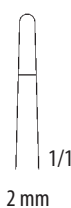
114 08 1530
 19,3 cm

114 08 1540
 19,3 cm

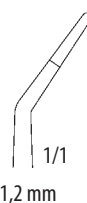
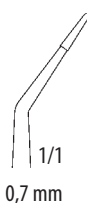

1/2

114 08 1560
 16,5 cm

114 08 1570
 16,5 cm

114 08 1580
 16,5 cm

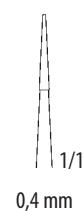
114 08 1690
 16,3 cm

114 08 1700
 16,3 cm

114 08 1710
 16,3 cm

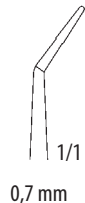
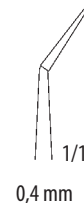
114 08 1720
 11,5 cm

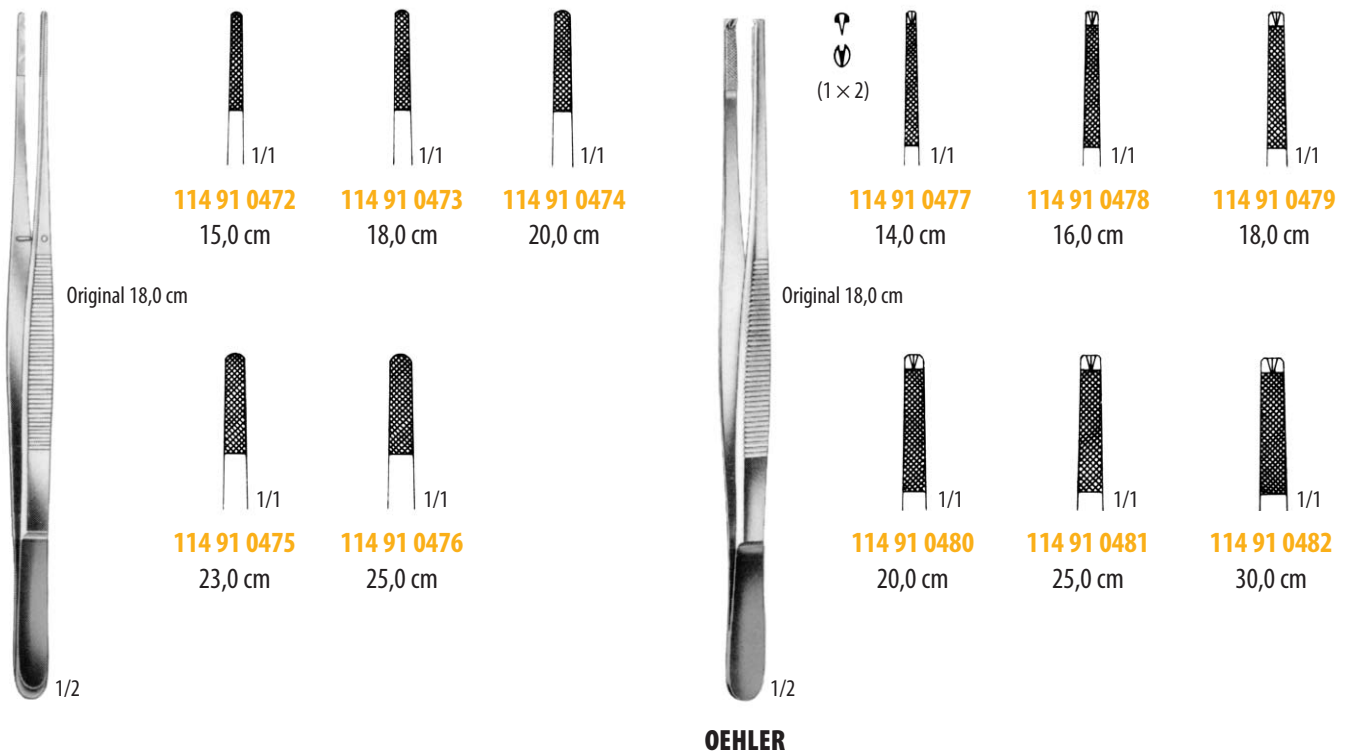
114 08 1730
 11,5 cm

1/2

114 08 1750
 11,3 cm

114 08 1760
 11,3 cm



SEMKEN
 114 91 0483 12,5 cm
 114 91 0484 15,5 cm



GILLIES
 114 91 0485 15,0 cm



JEWELER
 114 91 0486 15,0 cm

PINZETY TVRDOKOVOVÉ
FORCEPS WITH TUNGSTEN CARBIDE INSERT



Original 12,0 cm



114 91 0487
12,0 cm

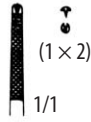

(1 × 2)
114 91 0490
12,0 cm



114 91 0489
15,0 cm

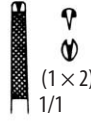

(1 × 2)
114 91 0491
15,0 cm

ADSON

1/2

1/1

1/1



1/2



114 91 0492

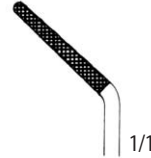

114 91 0493



1/1



1/2

CUSHING
17,5 cm

CUSHING-TAYLOR
114 91 0494
18,0 cm



Original 24,0 cm

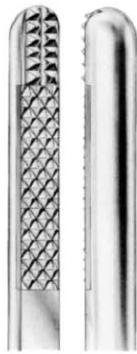

3/1

DE BAKY

1,5 cm

114 91 0495 16,0 cm

114 91 0496 20,0 cm

114 91 0497 24,0 cm

2,0 cm

114 91 0498 16,0 cm

114 91 0499 20,0 cm

114 91 0500 24,0 cm

1/2



1/2

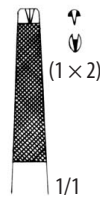

1/1

BONNEY
114 91 0501
18,0 cm



1/2

Original 23,0 cm



1/1

114 91 0502
15,0 cm



1/1

114 91 0503
23,0 cm

WANGENSTEEN





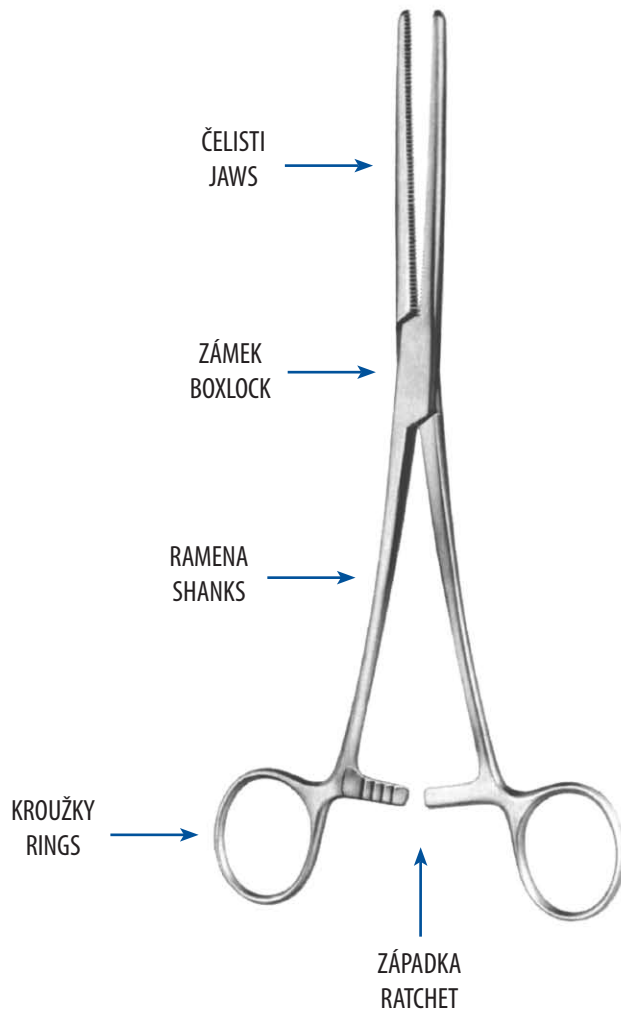

 ŠPIČKA
TIPS

 BEZ ZUBŮ
WITHOUT TEETH

(1 × 2)

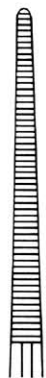
 SE ZUBY 1 × 2
WITH TEETH 1 × 2

 ZAKŘIVENÍ ČELISTI
JAW CURVATURE

 ROVNÁ
STRAIGHT

 ZAHNUTÁ
CURVED

 VROUBKOVÁNÍ
SERRATIONS

 HORIZONTÁLNÍ
HORIZONTAL

 PODÉLNÉ
LONGITUDINAL

 KRÍŽENÉ
CROSS



1/2

MICRO-BULLDOG

115 14 0010

2,6 cm



1/2

MICRO-BULLDOG

115 14 0020

2,4 cm

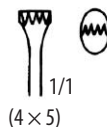

1/2

ALLIS
115 91 0364
15,0 cm

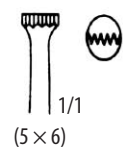

1/2

ALLIS
115 91 0365 15,0 cm
115 91 0366 19,0 cm
115 91 0367 25,0 cm



Original 18,0 cm

1/2

BABCOCK



1/1

115 91 0382
16,0 cm



1/1

115 91 0384
18,0 cm



1/1

115 91 0385
20,0 cm



1/1

115 91 0386
24,0 cm

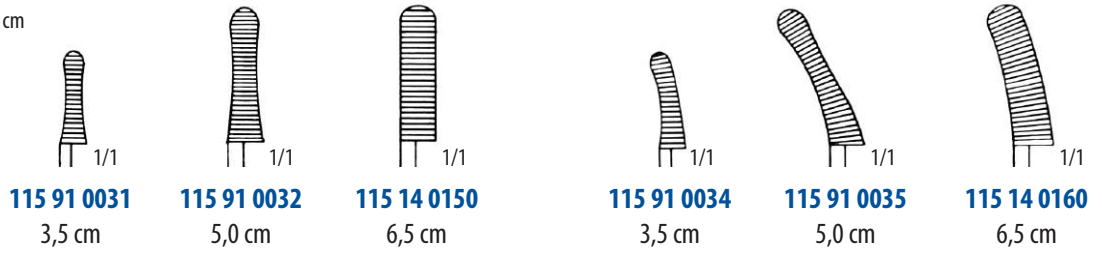
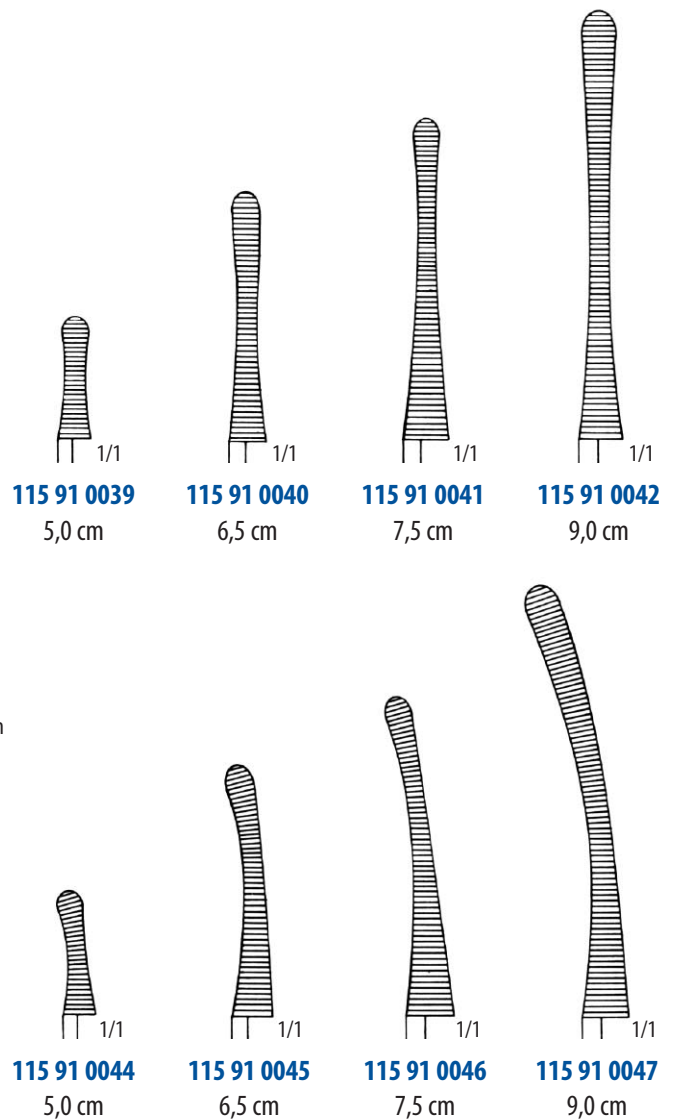

DIEFFENBACH

JOHNS-HOPKINS
115 91 0037
 24,5 cm



CHAPUT
115 91 0048
13,0 cm

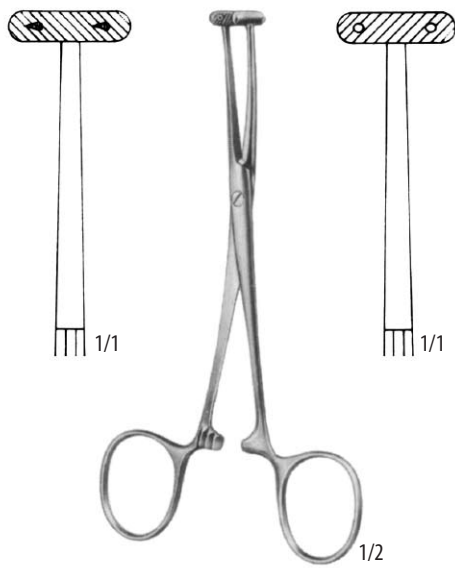

TUFFIER
115 91 0049
13,0 cm



MARTEL
115 91 0050
14,0 cm

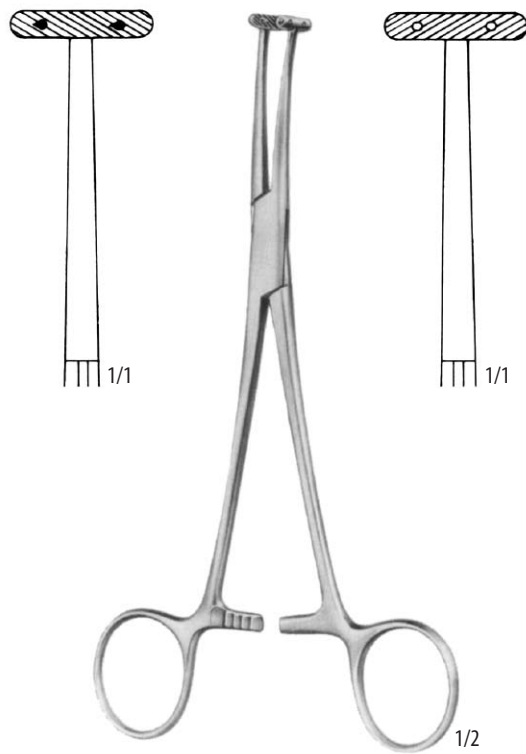

WILLET-MARTEL
115 91 0051
19,0 cm

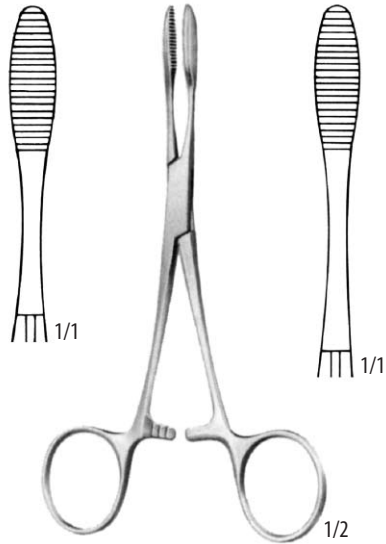

115 91 0052
14,0 cm

PEAN

115 91 0053
16,0 cm



115 08 0071
17,5 cm

PEAN

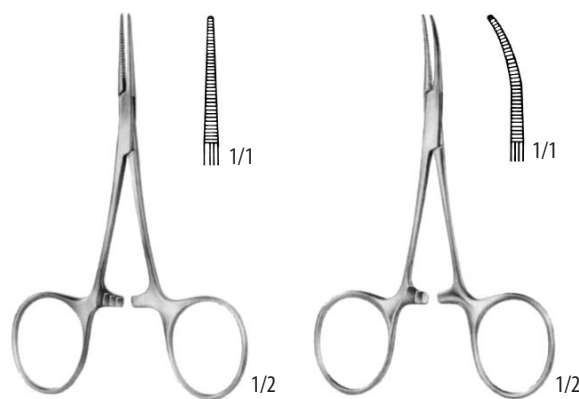

115 91 0068
10,0 cm

HARTMANN

115 91 0069
10,0 cm

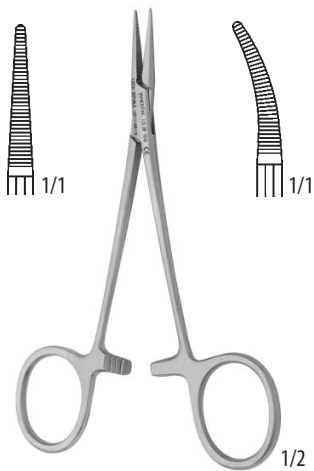
**MOSQUITO-HALSTED**

standard – standard

115 08 0010

12,0 cm

115 08 0020

12,0 cm

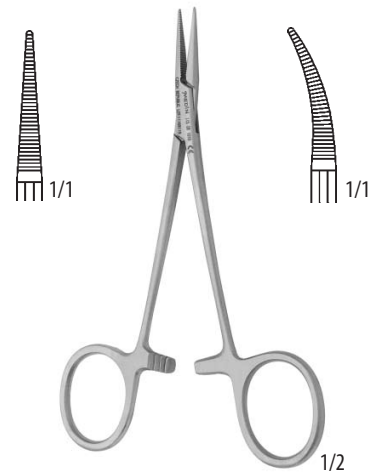
**MOSQUITO-HALSTED**

jemné – fine

115 08 1010

12,0 cm

115 08 1020

12,0 cm

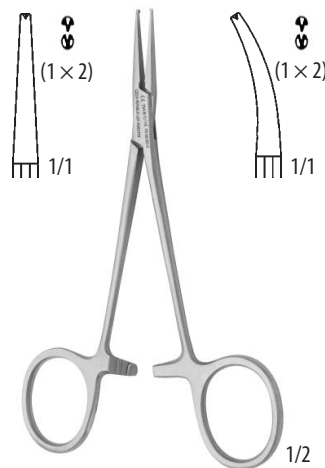
**MOSQUITO-HALSTED**

hladká čelist – smooth jaw

115 08 0040

12,0 cm

115 08 0060

12,0 cm

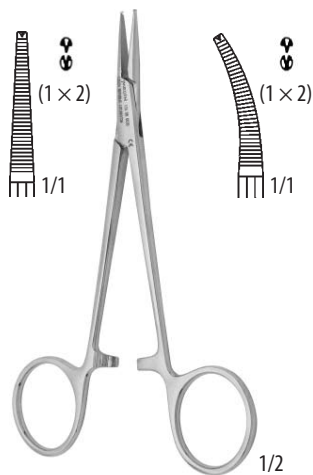
**MOSQUITO-HALSTEAD**

standard – standard

115 08 0030

12,0 cm

115 08 0050

12,0 cm

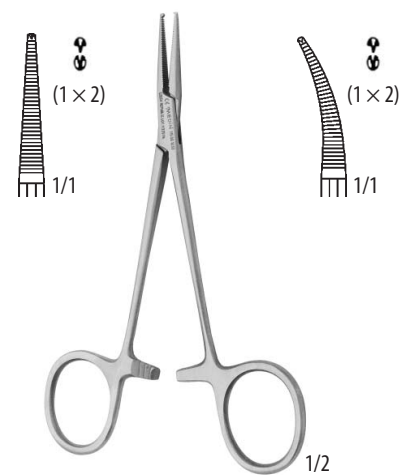
**MOSQUITO-HALSTEAD**

jemné – fine

115 08 1030

12,0 cm

115 08 1050

12,0 cm

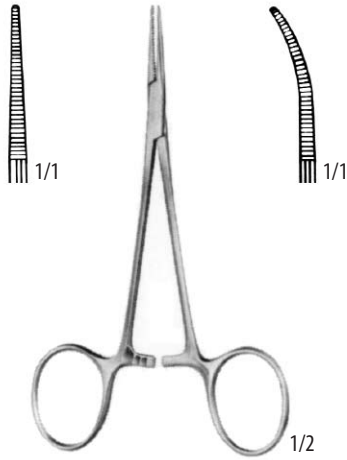
MICRO-MOSQUITO
115 91 0073

12,0 cm

115 91 0075

12,0 cm

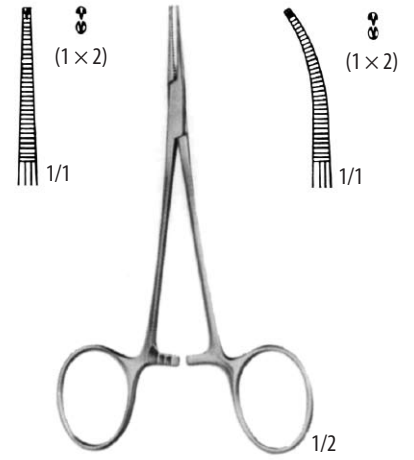
MICRO-MOSQUITO
115 91 0077

12,0 cm

115 91 0079

12,0 cm

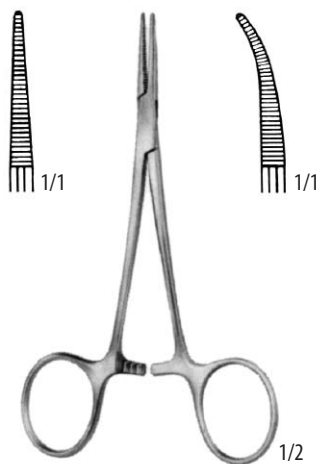
HALSTEAD-MOSQUITO
115 91 0080

12,5 cm

115 91 0082

12,5 cm

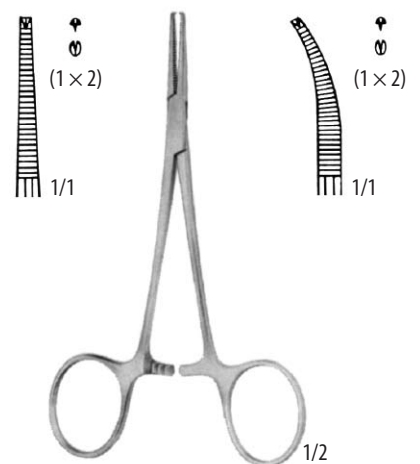
HALSTEAD-MOSQUITO
115 91 0084

12,5 cm

115 91 0086

12,5 cm

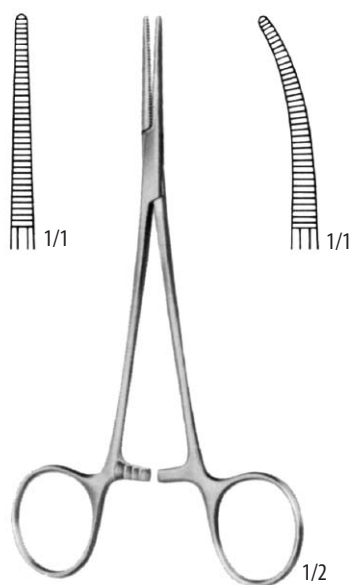
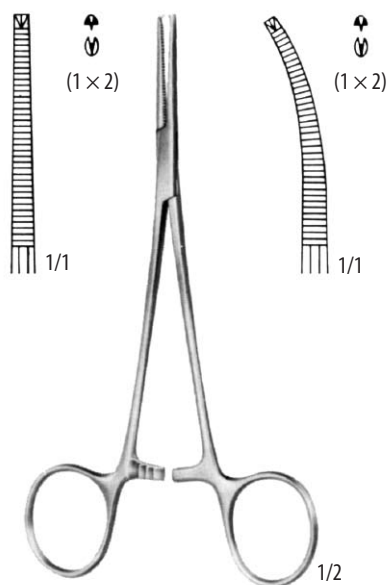
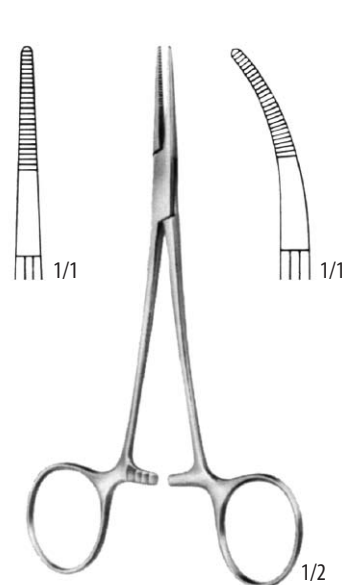
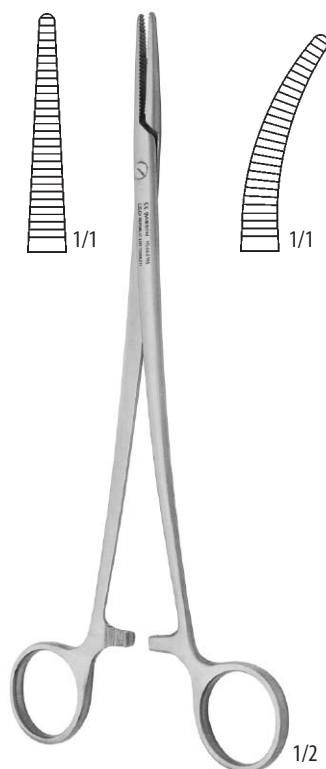
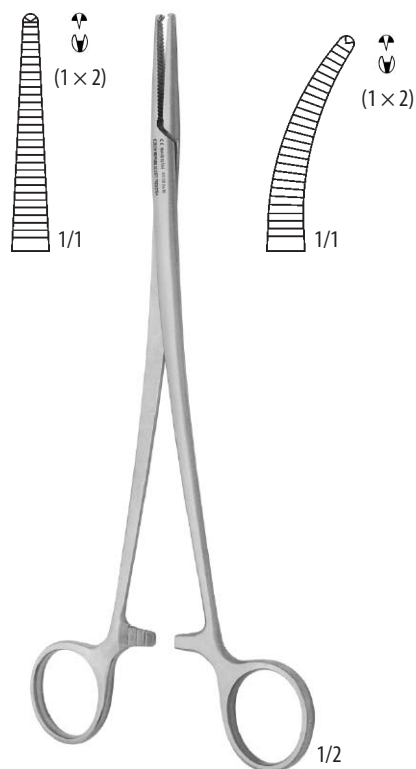
**LERICHE**115 91 0097
15,0 cm115 91 0098
15,0 cm**LERICHE**115 91 0099
15,0 cm115 91 0100
15,0 cm**PROVIDENCE-HOSPITAL**115 91 0101
14,0 cm115 91 0102
14,0 cm**PEAN**115 08 0190
20,0 cm115 08 0200
20,0 cm**KOCHER**

jemné – fine

115 08 0410
20,0 cm115 08 0420
20,0 cm

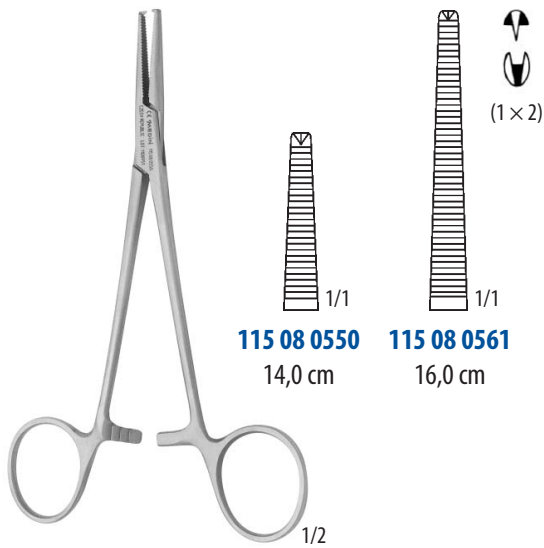

115 08 0550
14,0 cm

115 08 0561
16,0 cm

ROCHESTER-OCHSNER

115 08 0550

14,0 cm

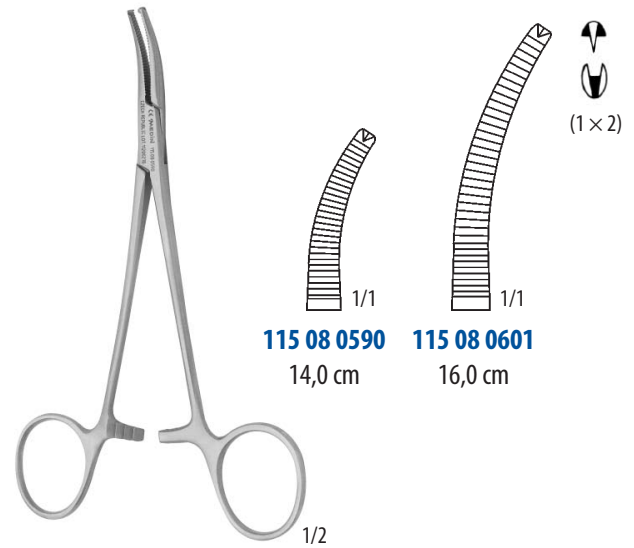

115 08 0590
14,0 cm

115 08 0601
16,0 cm

ROCHESTER-OCHSNER

115 08 0590

14,0 cm

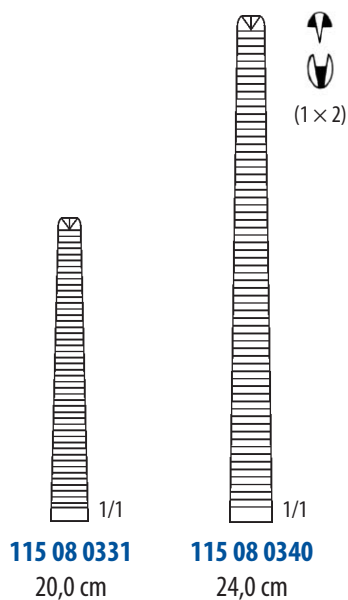

115 08 0331
20,0 cm

115 08 0340
24,0 cm



KOCHER
115 08 0331
20,0 cm

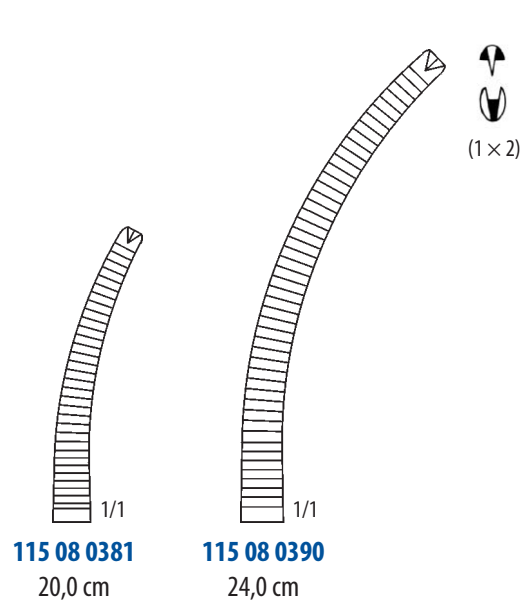

115 08 0381
20,0 cm

115 08 0390
24,0 cm

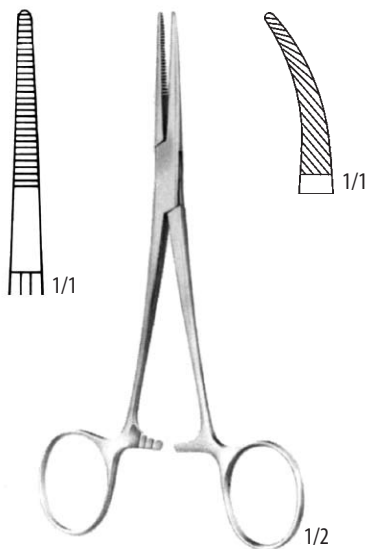

KELLY

115 91 0103
14,0 cm

115 08 0500
14,0 cm

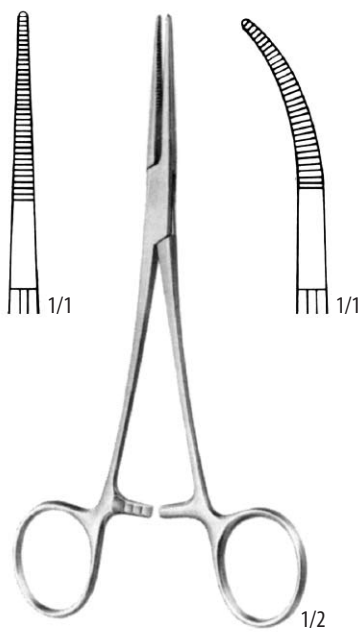

KELLY-RANKIN

115 91 0105
16,0 cm

115 91 0106
16,0 cm

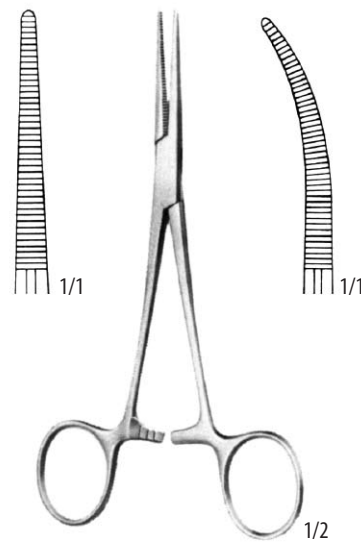

CRILE

115 91 0111
14,0 cm

115 91 0112
14,0 cm

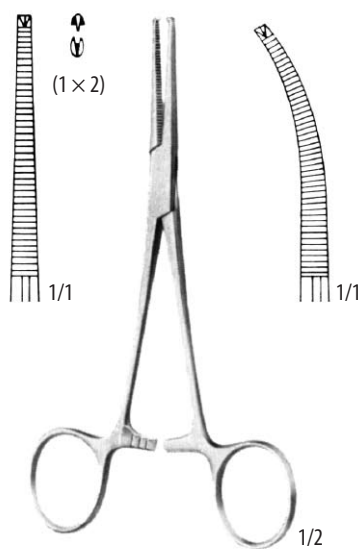

CRILE

115 91 0113
14,0 cm

115 91 0114
14,0 cm

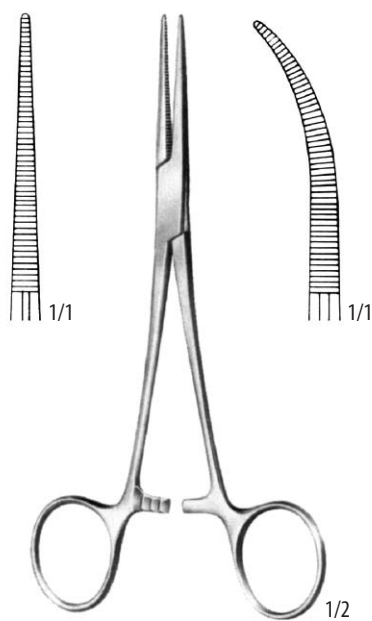

CRILE-RANKIN

115 91 0115
16,0 cm

115 91 0116
16,0 cm

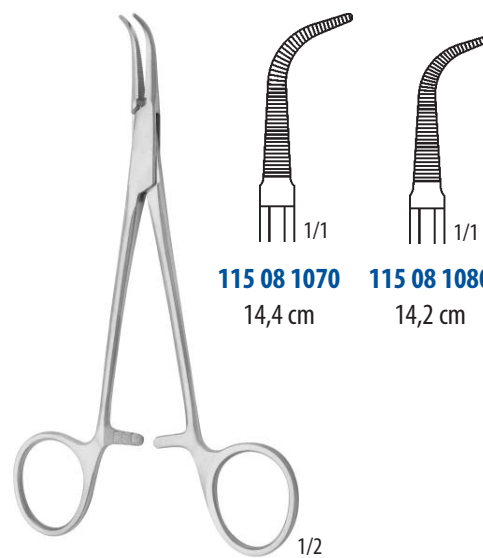

PEAN

115 08 1070
14,4 cm

115 08 1070
14,4 cm

115 08 1080
14,2 cm

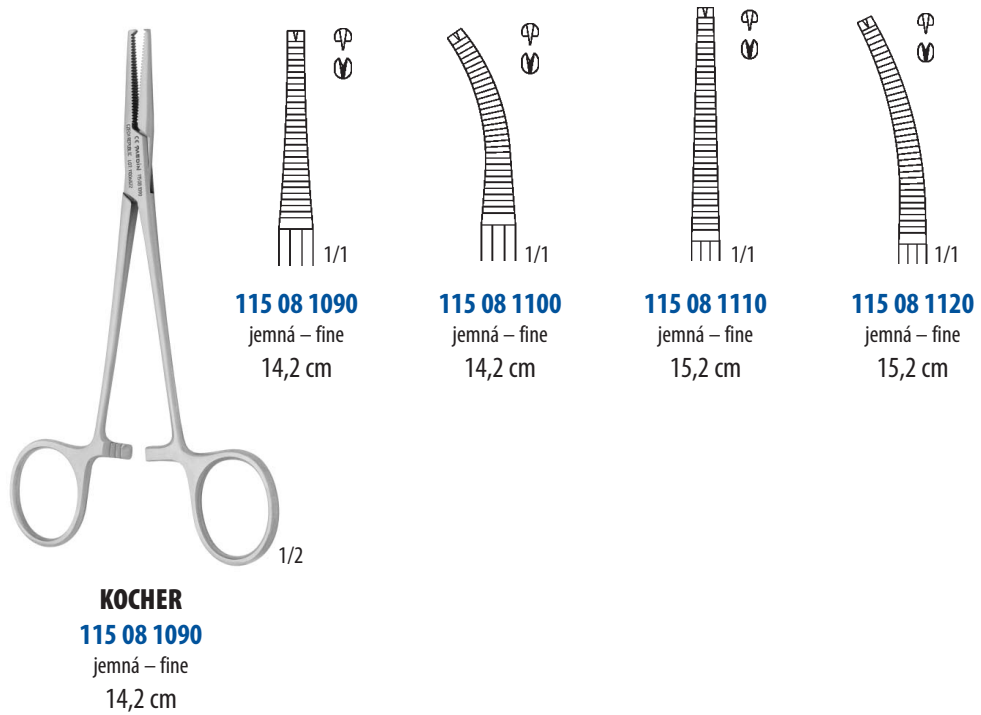
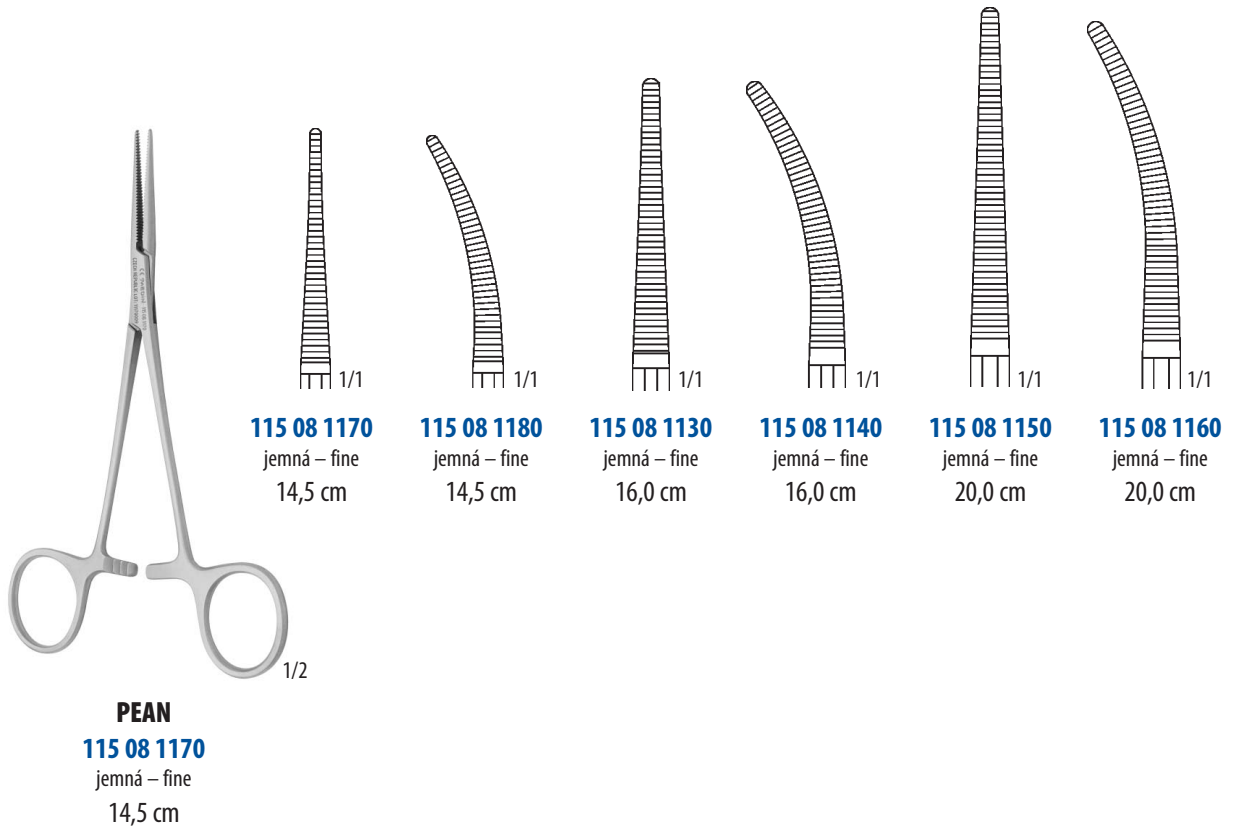

**ROCHESTER-PEAN****115 08 0231**

16,0 cm

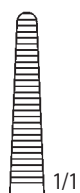

1/1

115 08 0220

14,0 cm

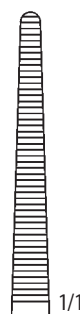

1/1

115 08 0231

16,0 cm

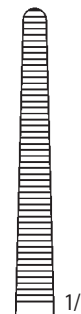

1/1

115 08 0121

20,0 cm

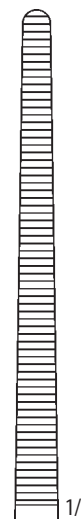

1/1

115 08 0130

24,0 cm



1/1

115 91 0117

14,0 cm

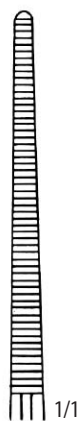

1/1

115 91 0118

16,0 cm

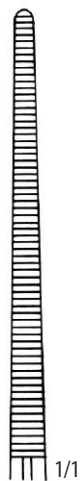

1/1

115 91 0119

18,0 cm

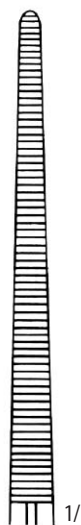

1/1

115 91 0120

20,0 cm

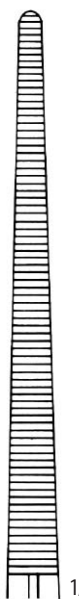

1/1

115 91 0121

22,0 cm

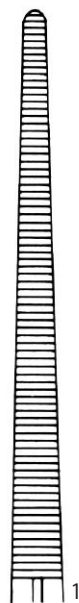

1/1

115 91 0122

24,0 cm

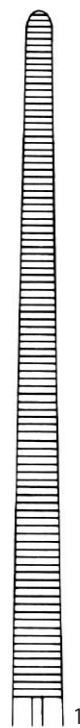

1/1

115 91 0123

26,0 cm

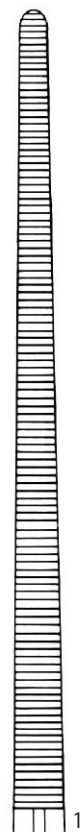

1/1

115 91 0124

30,0 cm

ROCHESTER-PEAN
115 08 0271

16,0 cm

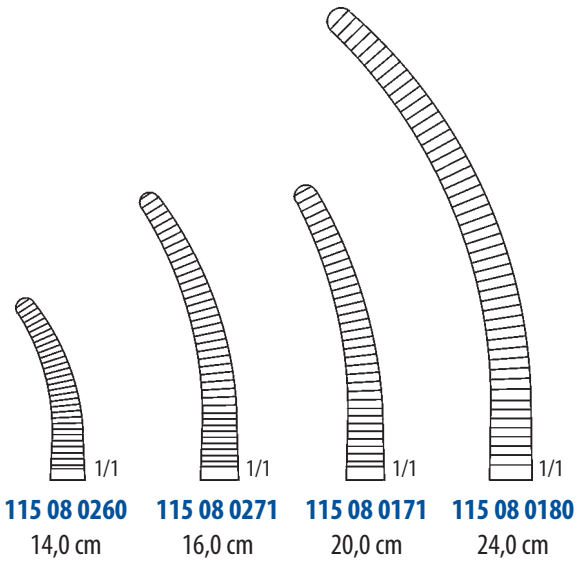
115 08 0260

14,0 cm

115 08 0271

16,0 cm

115 08 0171

20,0 cm

115 08 0180

24,0 cm

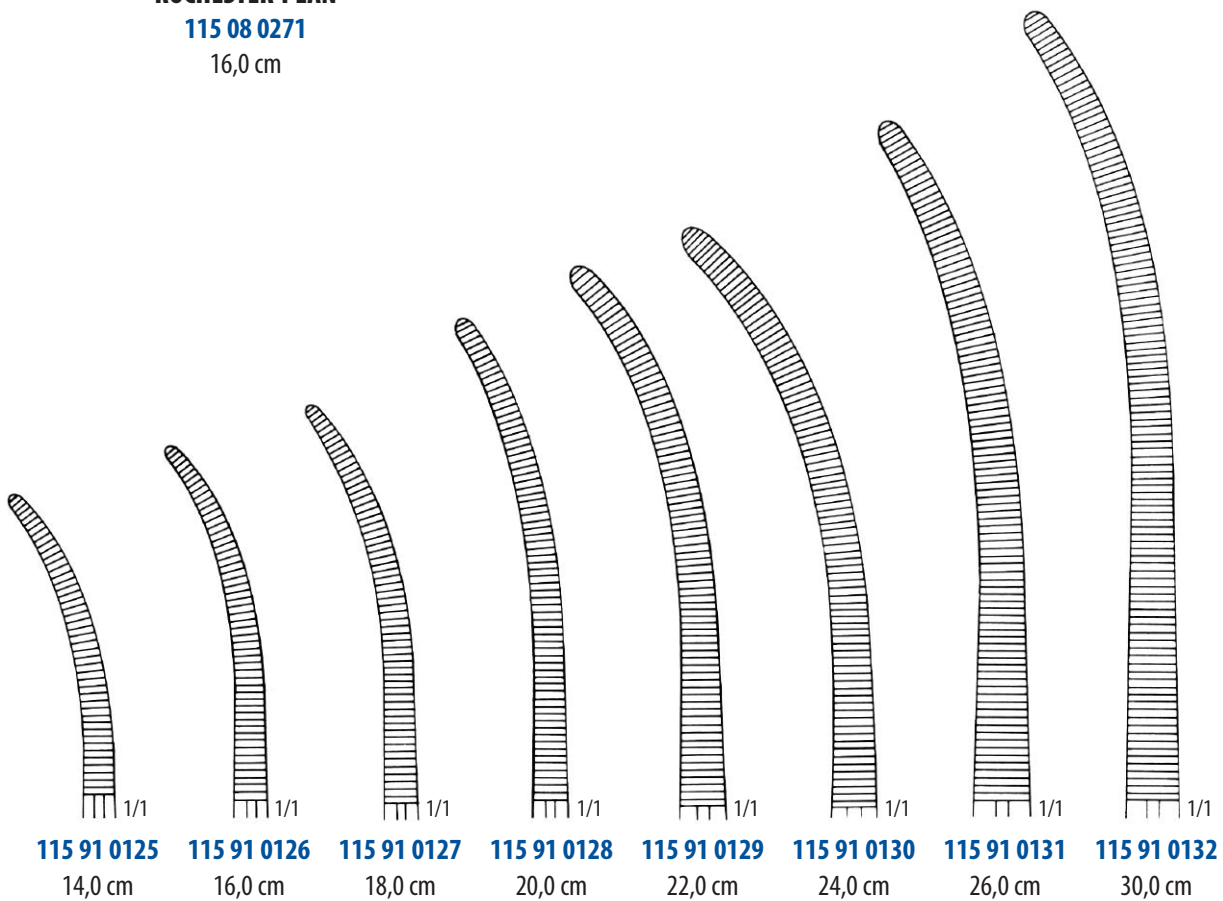
115 91 0125

14,0 cm

115 91 0126

16,0 cm

115 91 0127

18,0 cm

115 91 0128

20,0 cm

115 91 0129

22,0 cm

115 91 0130

24,0 cm

115 91 0131

26,0 cm

115 91 0132

30,0 cm

SVORKY NA CÉVY
ARTERY FORCEPS**OCHSNER-KOCHER****115 91 0138**

24,0 cm

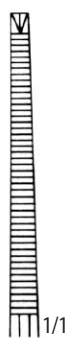
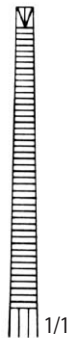
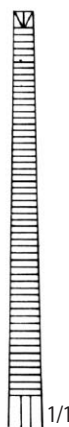
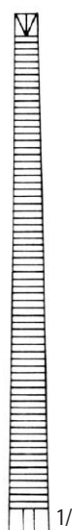
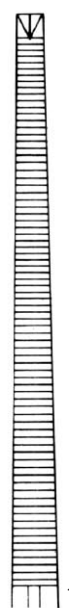
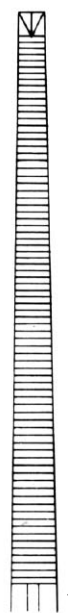
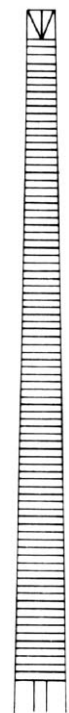
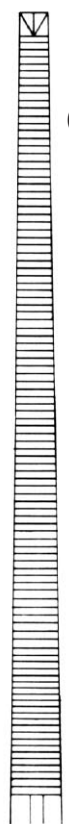
**115 91 0133**
14,0 cm**115 91 0134**
16,0 cm**115 91 0135**
18,0 cm**115 91 0136**
20,0 cm**115 91 0137**
22,0 cm**115 91 0138**
24,0 cm**115 91 0139**
26,0 cm**115 91 0140**
30,0 cm

(1 × 2)

OCHSNER-KOCHER
115 91 0138

24,0 cm

1/2

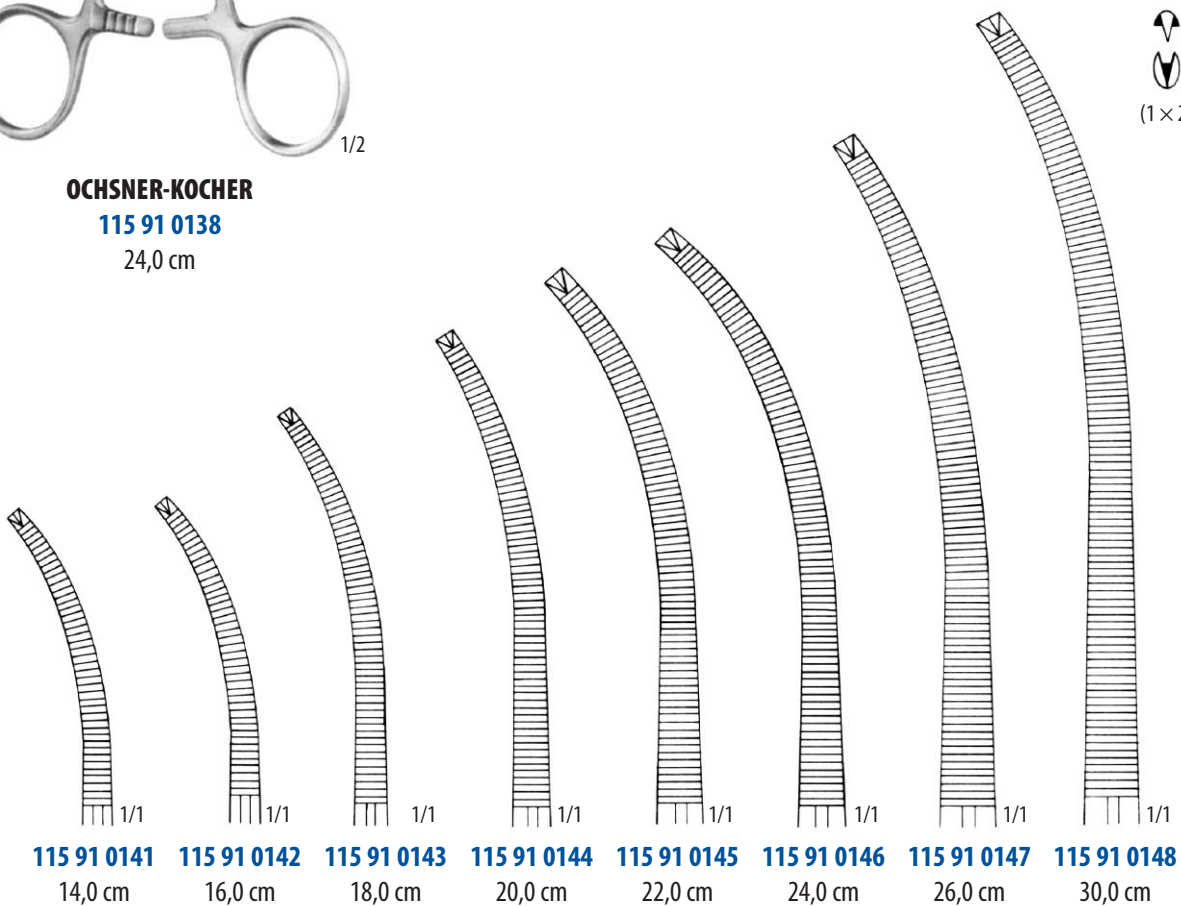
(1 × 2)

115 91 0141
14,0 cm

115 91 0142
16,0 cm

115 91 0143
18,0 cm

115 91 0144
20,0 cm

115 91 0145
22,0 cm

115 91 0146
24,0 cm

115 91 0147
26,0 cm

115 91 0148
30,0 cm

SVORKY NA CÉVY
ARTERY FORCEPS



1/2

OVERHOLT-GEISSENDOERFER

115 91 0161

21,0 cm

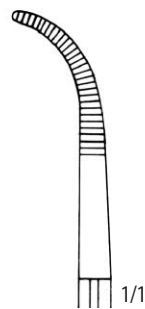

Fig. 1

21,0 cm
27,0 cm

115 91 0161

115 91 0168

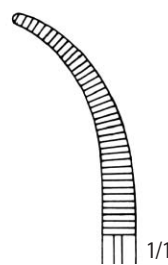

Fig. 2

115 91 0162

115 91 0169

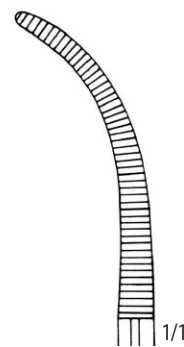

Fig. 3

115 91 0163

115 91 0170

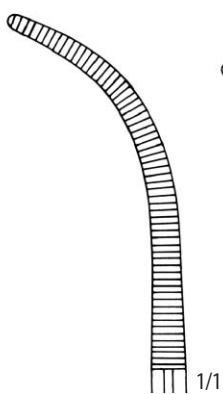

Fig. 4

21,0 cm
27,0 cm

115 91 0164

115 91 0171

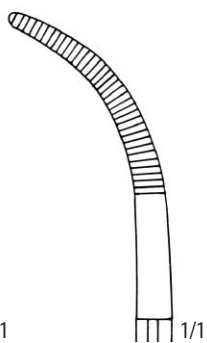

Fig. 5

115 91 0165

115 91 0172

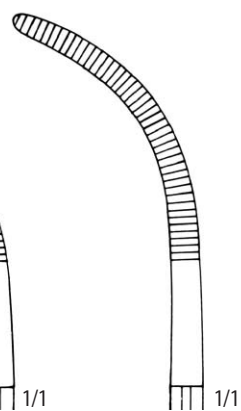

Fig. 6

115 91 0166

115 91 0173

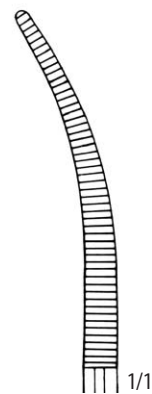

Fig. 7

115 91 0167

115 91 0174



1/1

115 14 1150

19,5 cm

Fig. 1

1/1

115 14 1160

22,2 cm

Fig. 2

Original 19,5 cm

1/2

OVERHOLT

19,5 cm

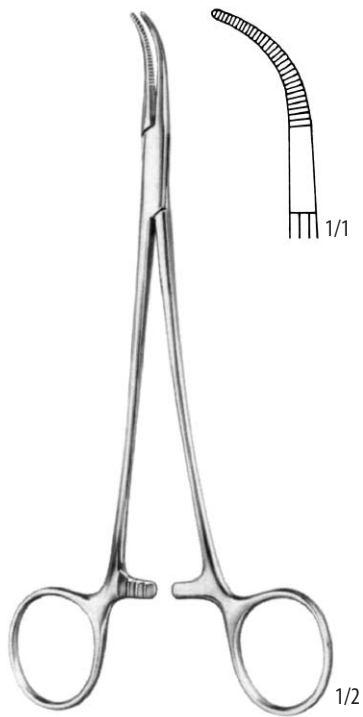

OVERHOLT
115 91 0176
 18,5 cm

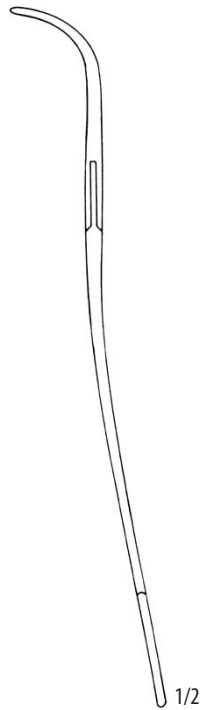

OVERHOLT
115 91 0177
 20,5 cm

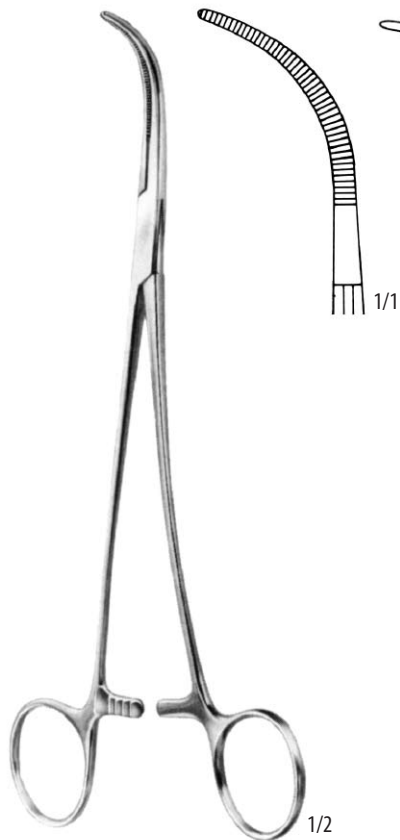

OVERHOLT
115 91 0178
 21,0 cm

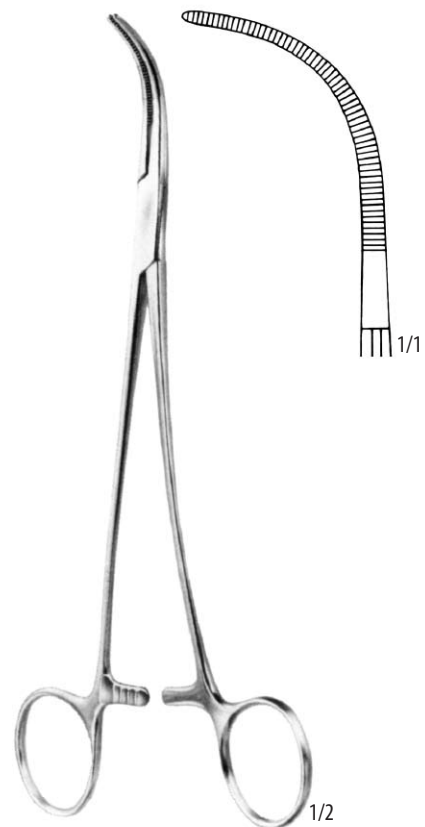
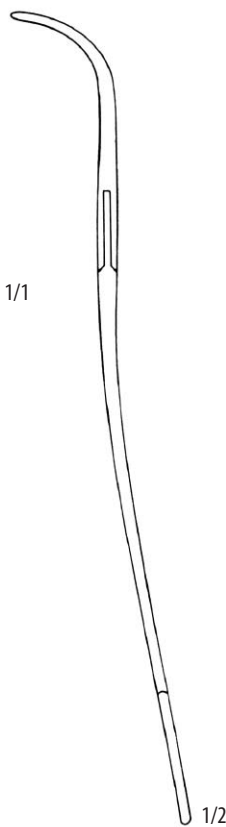

OVERHOLT
115 91 0179
 21,5 cm



BABY-ADSON
115 91 0180
14,0 cm



BABY-ADSON
115 91 0181
18,0 cm

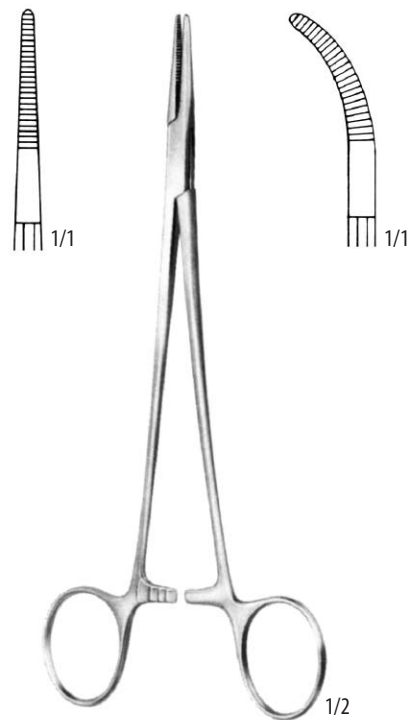

ADSON
115 91 0182
18,5 cm

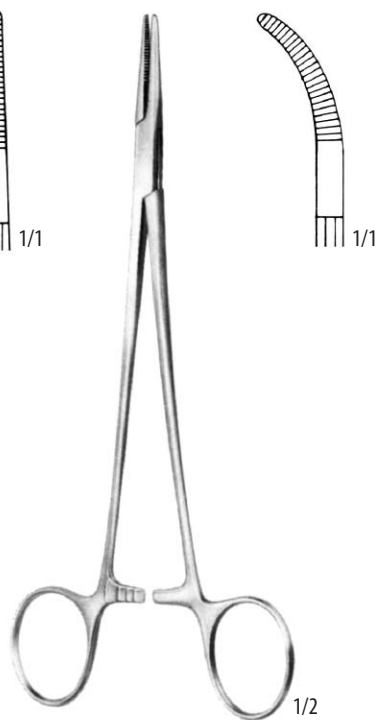

ADSON
115 91 0183
18,5 cm

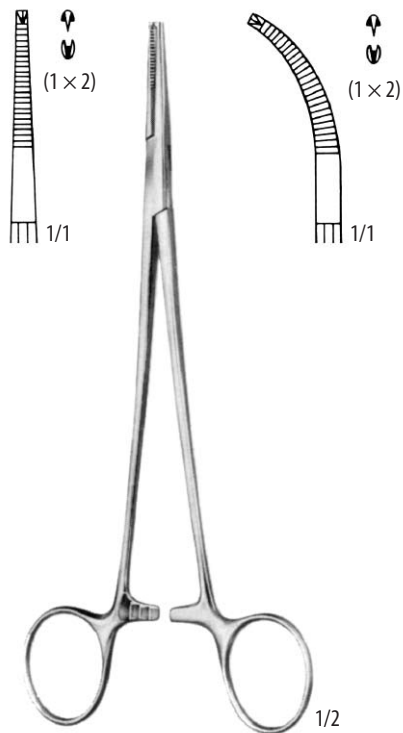

ADSON
115 91 0184
18,5 cm



ADSON
115 91 0185
18,5 cm



MEEKER
115 91 0186
18,0 cm



MEEKER
115 91 0187
28,0 cm

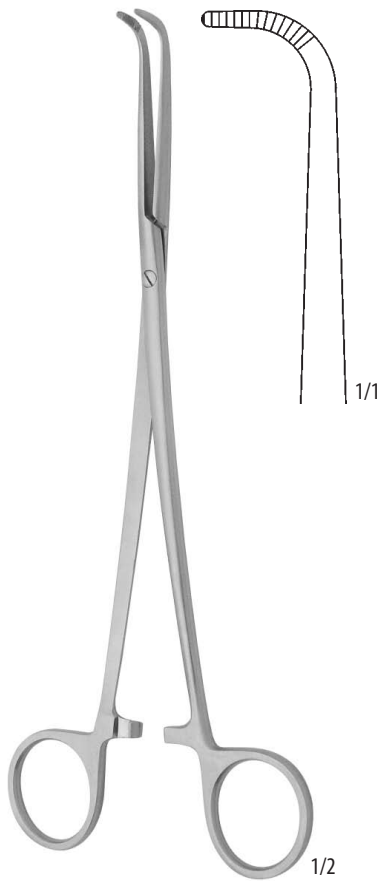

KELLY
115 08 0520
22,5 cm

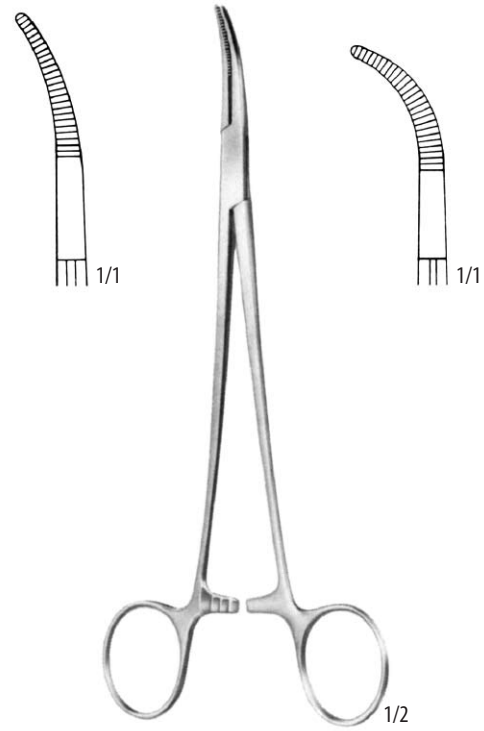

SCHNIDT-SAWTELL
115 91 0192 **115 91 0193**
19,0 cm 19,0 cm

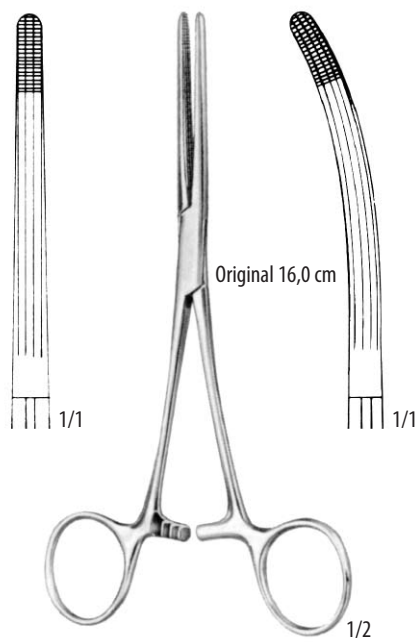

ROCHESTER-CARMALT
115 91 0196 16,0 cm **115 91 0198**
115 91 0197 20,0 cm **115 91 0199**

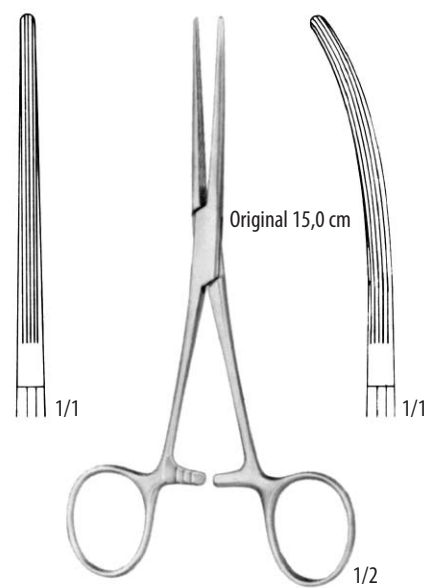

BAINBRIDGE
115 91 0200 15,0 cm **115 91 0202**
115 91 0201 18,5 cm **115 91 0203**

SVORKY NA CÉVY
ARTERY FORCEPS

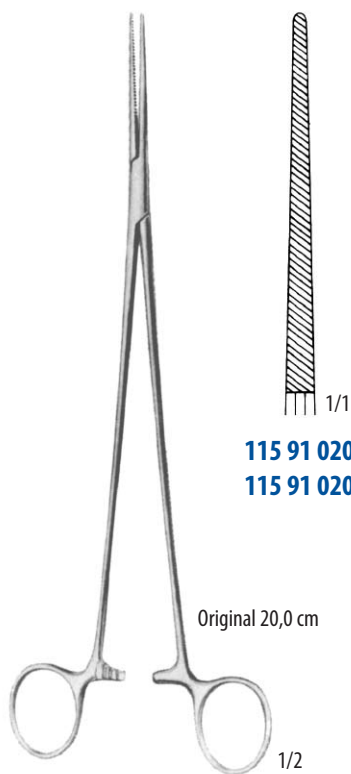

Original 20,0 cm

BENGOLEA

115 91 0204
115 91 0205

20,0 cm
26,0 cm

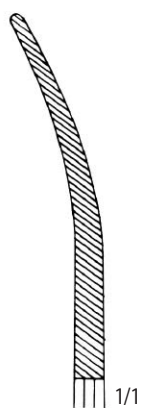

115 91 0206
115 91 0207

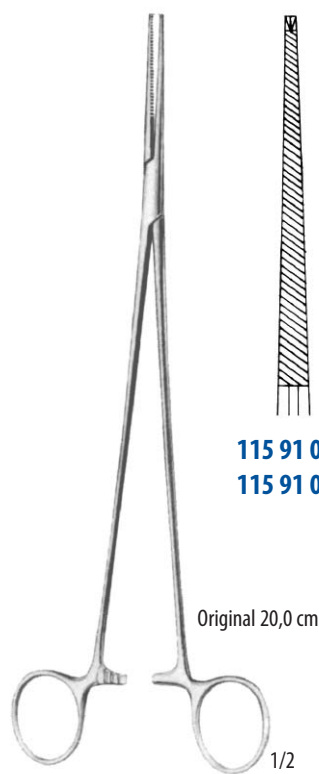

Original 20,0 cm

BENGOLEA

115 91 0208
115 91 0209

20,0 cm
26,0 cm



Original 24,0 cm

GRAFOORD-SELLORS

115 91 0212
22,0 cm

115 91 0213
23,0 cm

115 91 0214
24,0 cm



OVERHOLT-MIXTER

115 91 0215
21,0 cm

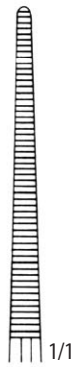

115 91 0216
20,0 cm
Fig. 1

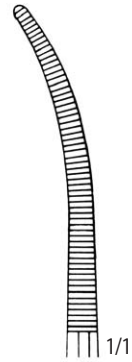

115 91 0217
20,0 cm

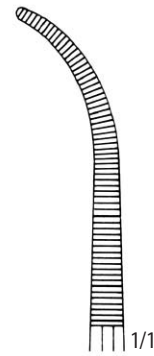

115 91 0218
20,0 cm

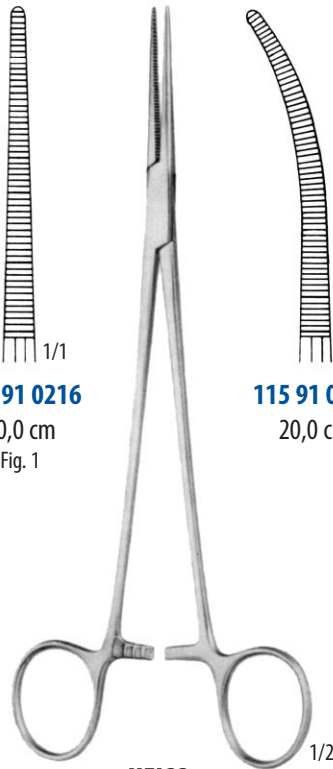

HEISS

1/2

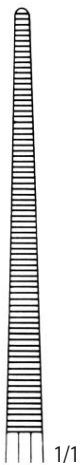

115 91 0219
22,0 cm

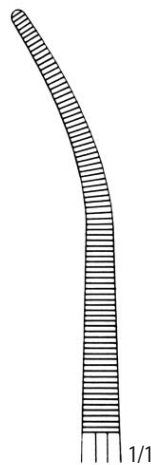

115 91 0220
22,0 cm

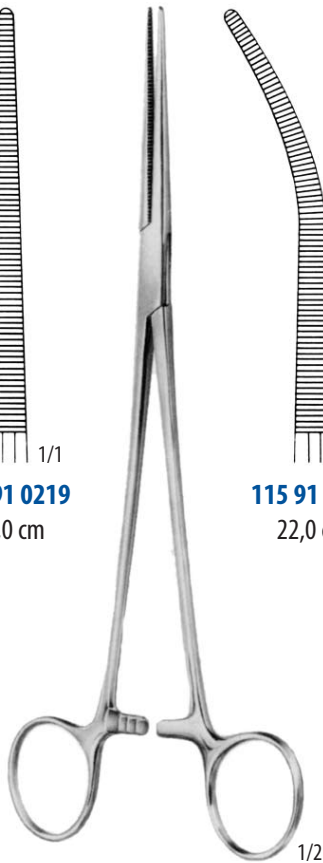

ROBERTS

1/2

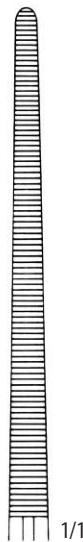

115 91 0221
24,0 cm

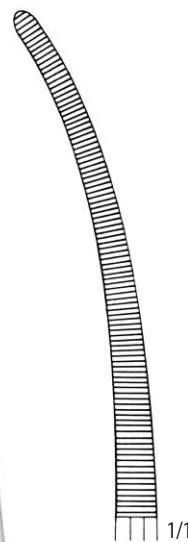

115 14 1600
23,0 cm

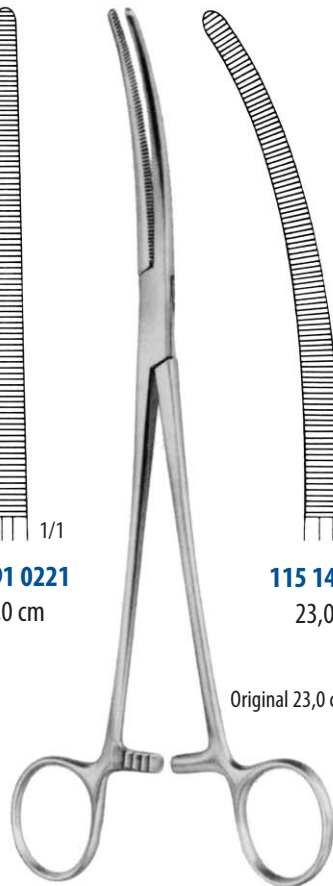

SAROT

1/2

Original 23,0 cm

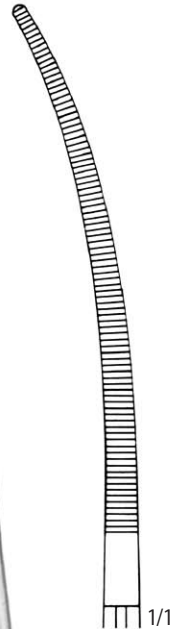

115 91 0223
24,0 cm

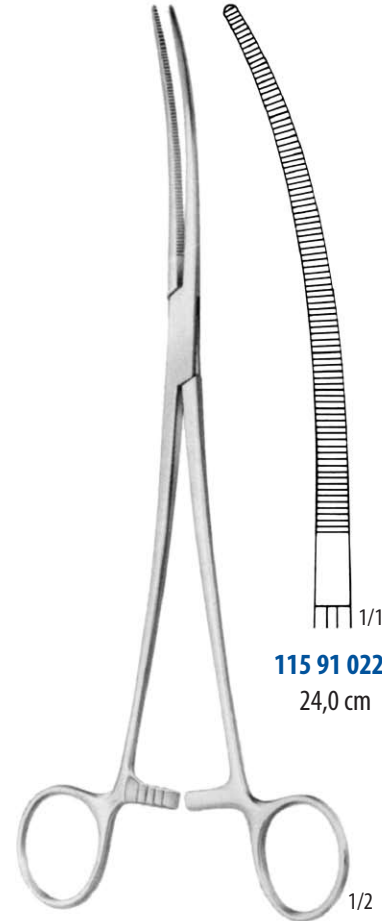

CRAFOORD

1/2



RUMEL
23,0 cm

1/2

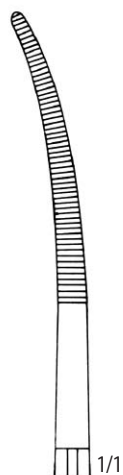

115 91 0224
23,0 cm
Fig. 1

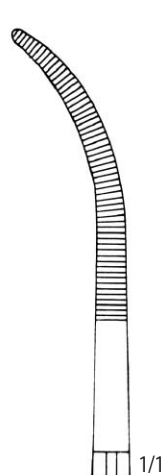

115 91 0225
23,0 cm
Fig. 2

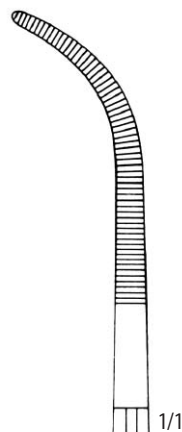

115 91 0226
23,0 cm
Fig. 3

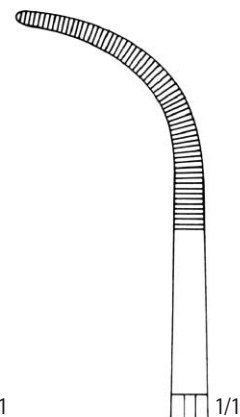

115 91 0227
23,0 cm
Fig. 4



ZENKER
29,5 cm

1/2

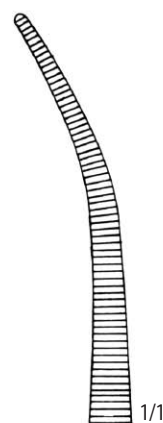

115 91 0229
29,5 cm

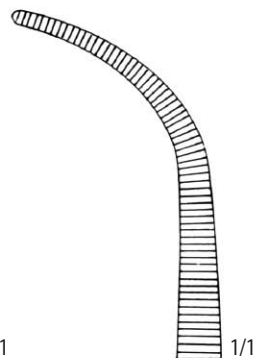

115 91 0230
29,5 cm

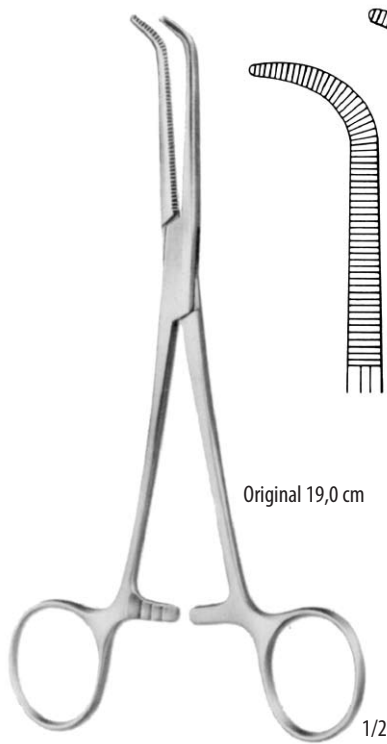
MIXTER

115 91 0231 15,5 cm
115 91 0232 19,0 cm

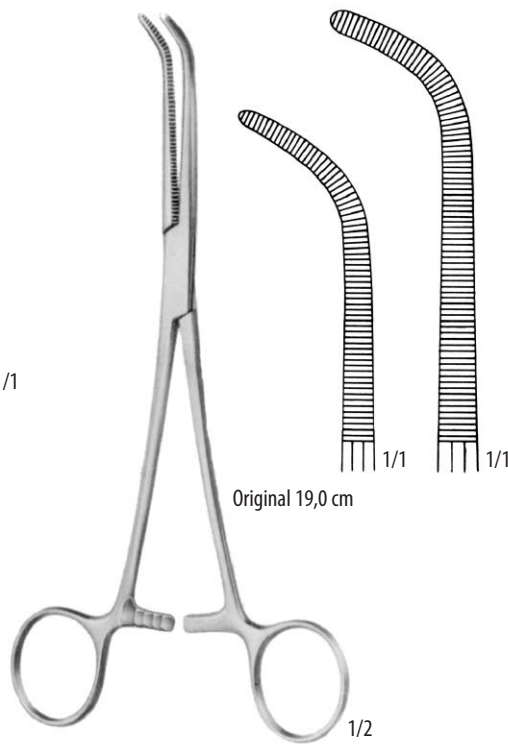
MIXTER-O'SHAUGNESSY

115 91 0233 15,5 cm
115 91 0234 19,0 cm

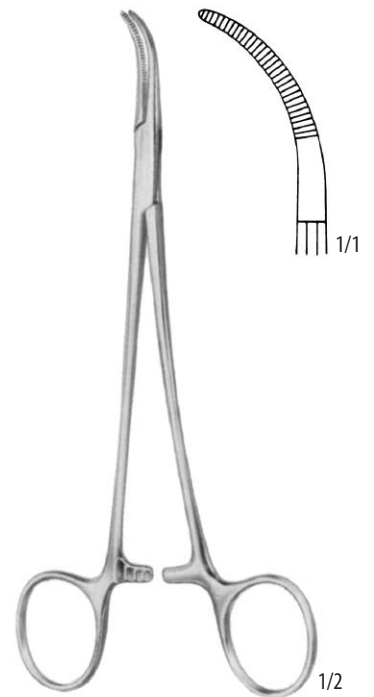
BABY-MIXTER

115 91 0235
18,0 cm

BABY-MIXTER

14,0 cm

115 91 0236

115 91 0237

MIXTER

22,0 cm

115 91 0238

22,0 cm

Fig. 1

115 91 0239

25,0 cm

Fig. 2

115 91 0240

28,0 cm

Fig. 3

**BRIDGE**

115 91 0242
28,0 cm

115 91 0243
28,0 cm

**LAWRENCE**

115 91 0244
28,0 cm

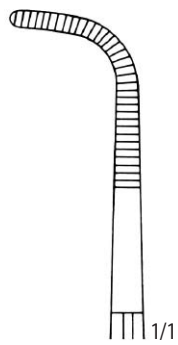
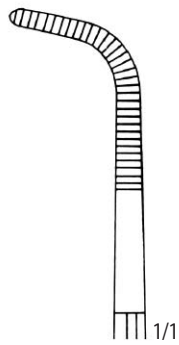
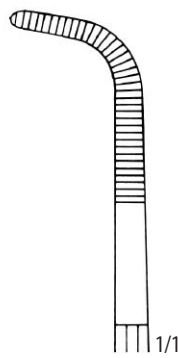

KANTROWITZ

Original 20,0 cm

115 91 0245
20,0 cm

115 91 0246
24,0 cm

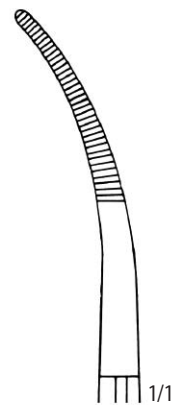
115 91 0247
28,0 cm

TOENNIS

Original 21,0 cm

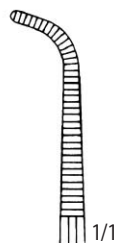
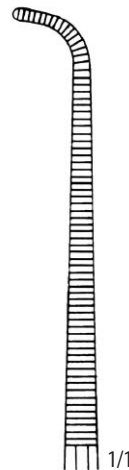
115 91 0253 21,0 cm **115 91 0255**
115 91 0254 26,0 cm **115 91 0256**

GEMINI

Original 18,0 cm

115 91 0249
18,0 cm

115 91 0251
25,0 cm

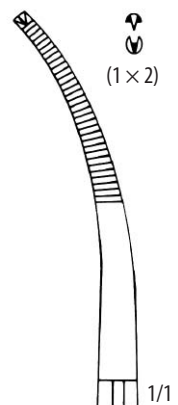
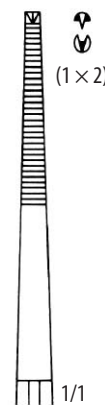
115 91 0252
28,0 cm

TOENNIS

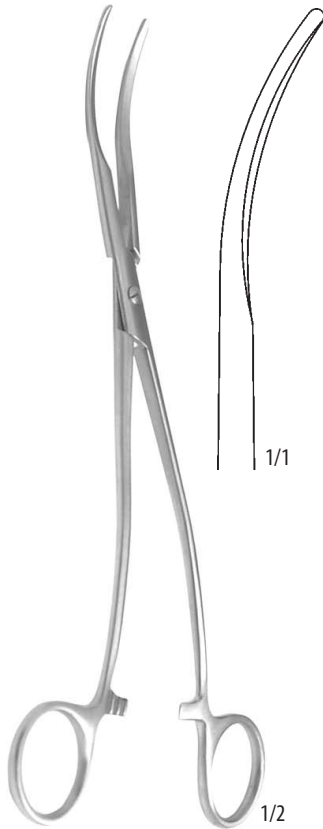
Original 21,0 cm

115 91 0257 21,0 cm **115 91 0259**
115 91 0258 26,0 cm **115 91 0260**



SEMB
115 14 1170
21,4 cm



SEMB
25,0 cm

115 14 1180

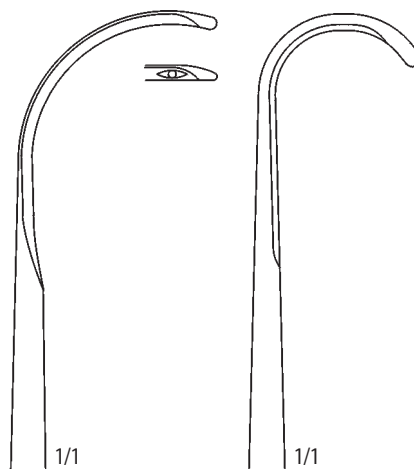

115 14 1190

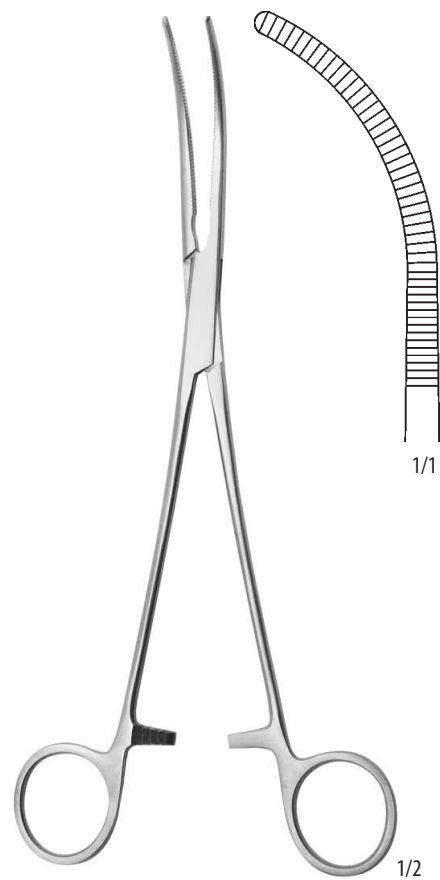

115 99 0074
22,8 cm

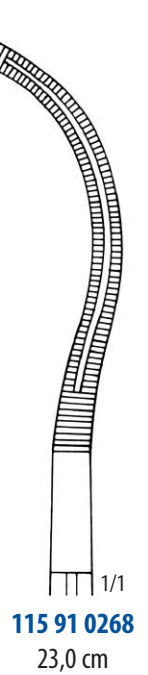
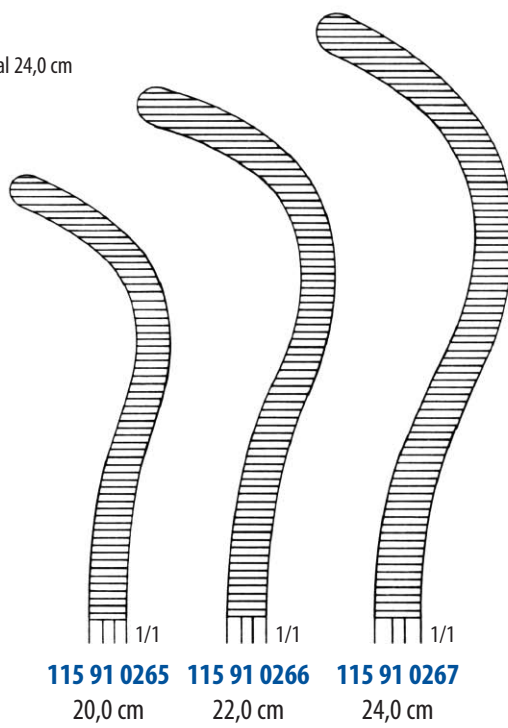
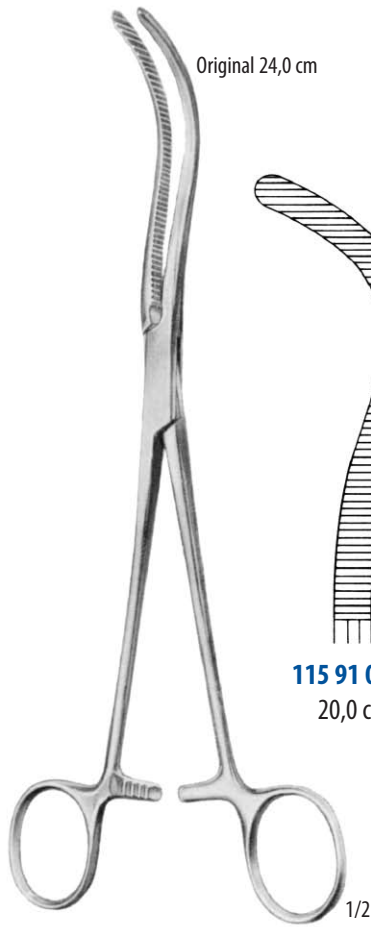

GUYON

STILLE

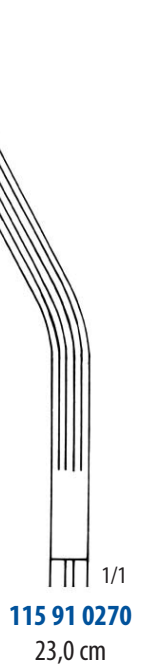
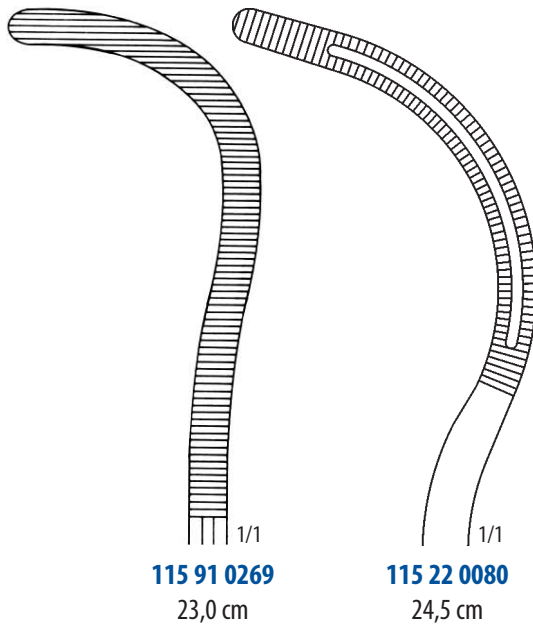

GUYON

STILLE

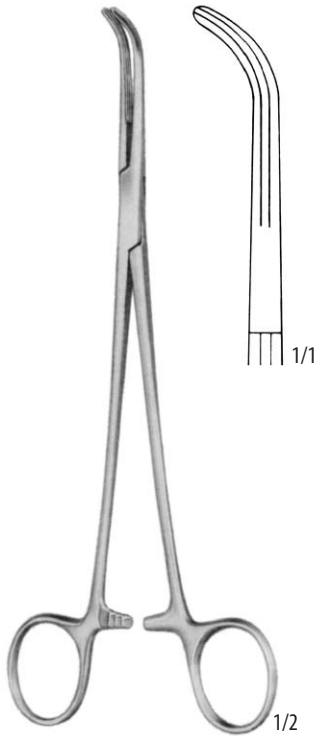

LAHEY
115 91 0261
19,0 cm

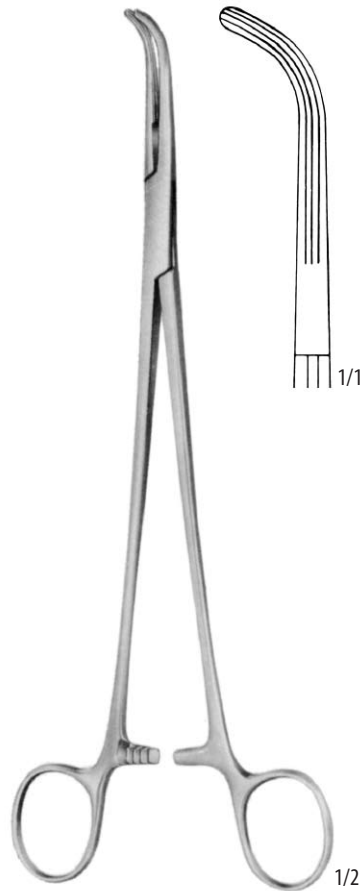

LAHEY
115 91 0262
23,0 cm



LOWER
115 91 0263
18,0 cm

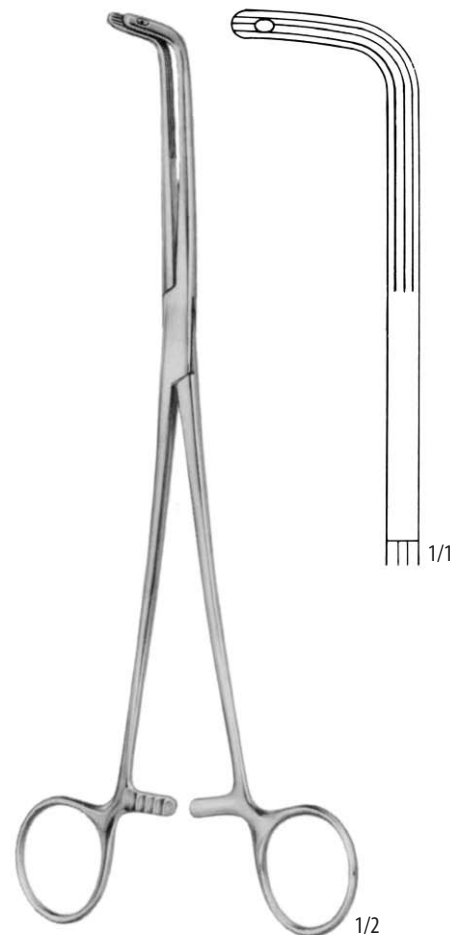

FINOCCHIETTO
115 91 0264
24,0 cm

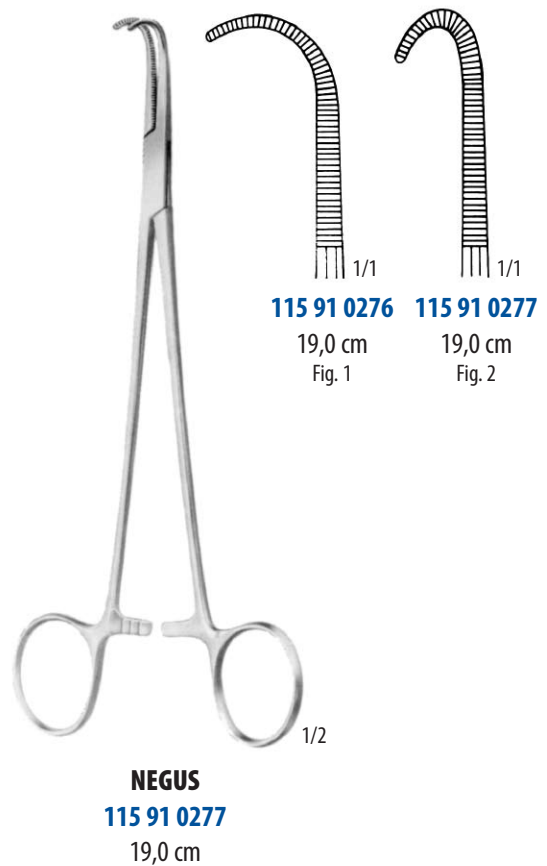
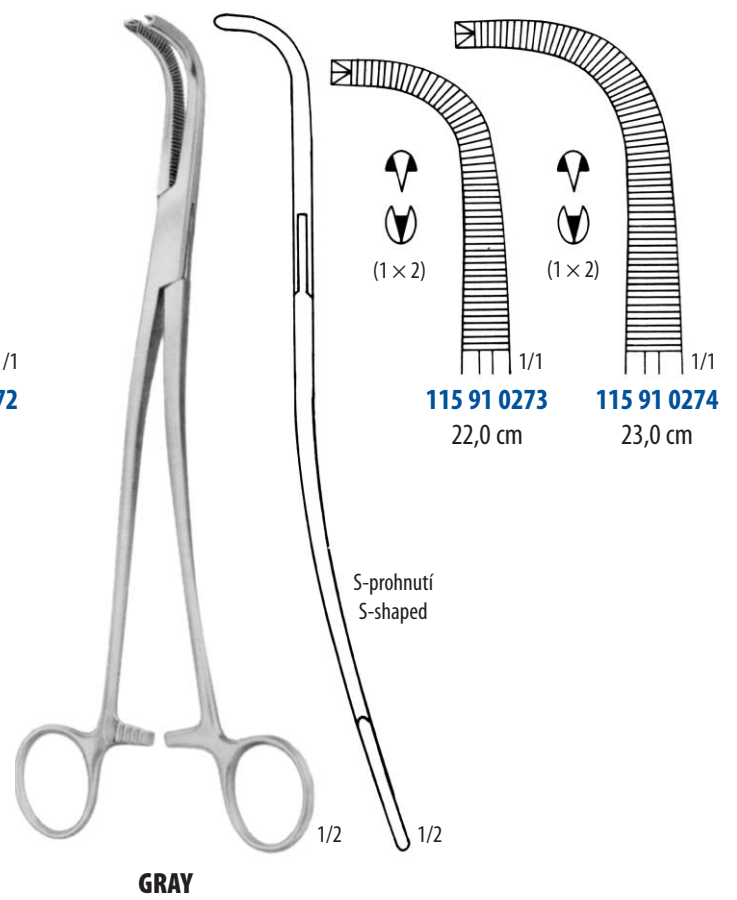
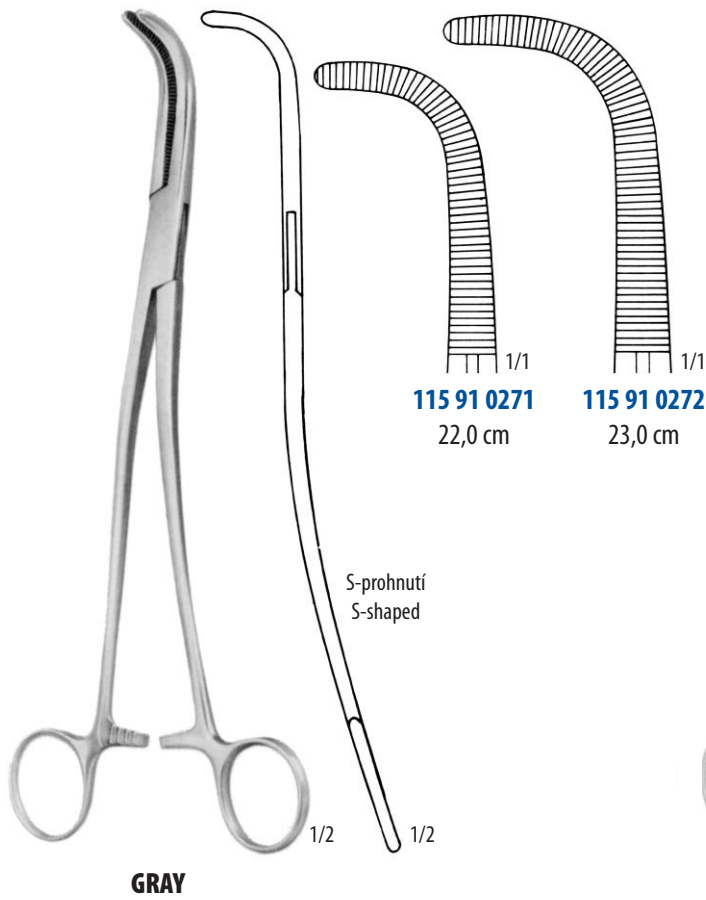

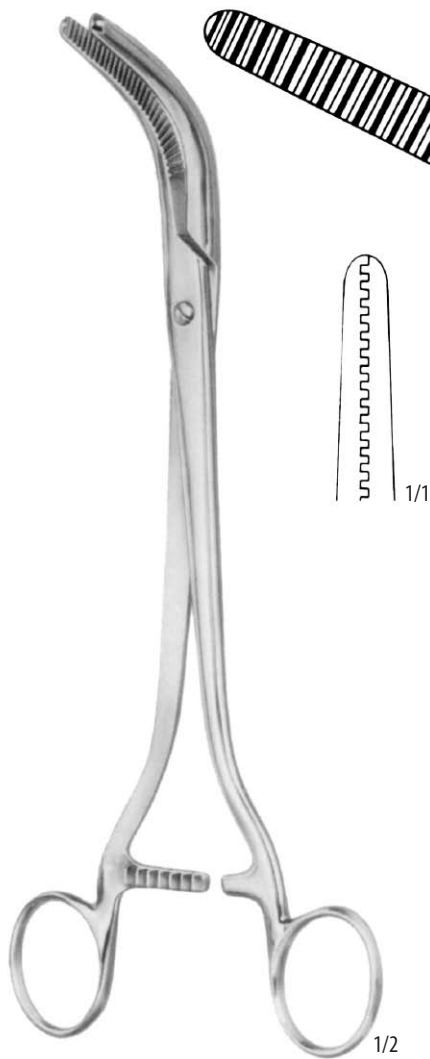
SVORKY NA HYSTEREKTOMII
 HYSTERECTOMY CLAMP-FORCEPS

WERTHEIM
115 91 0281
 27,0 cm

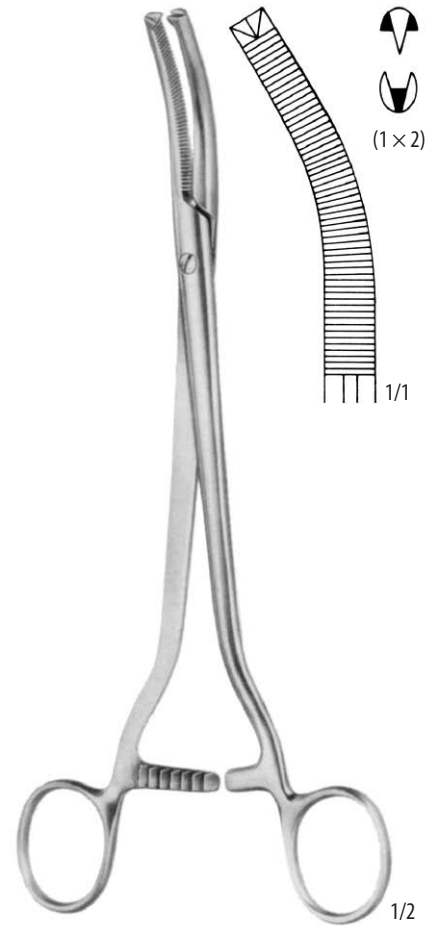
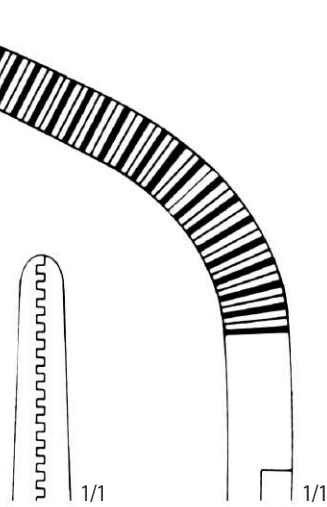

WERTHEIM
115 91 0282
 24,0 cm

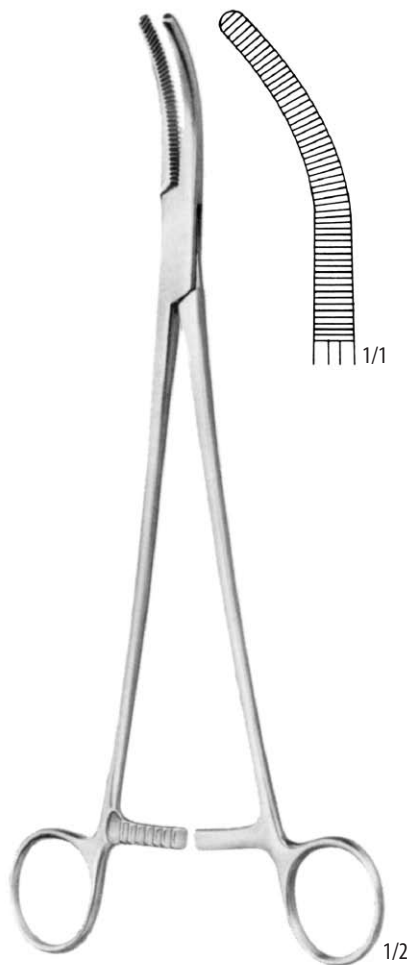

WERTHEIM
115 91 0283
 25,0 cm

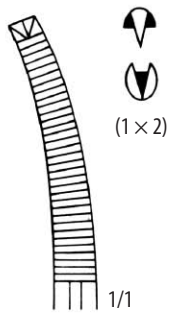

115 91 0284

lehce zahnuté – slightly curved

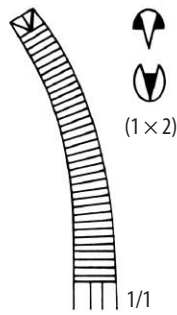

115 91 0285

více zahnuté – more curved

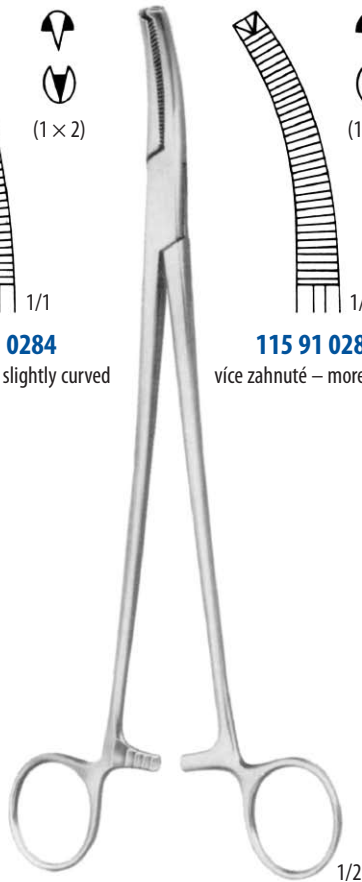

WERTHEIM
23,0 cm

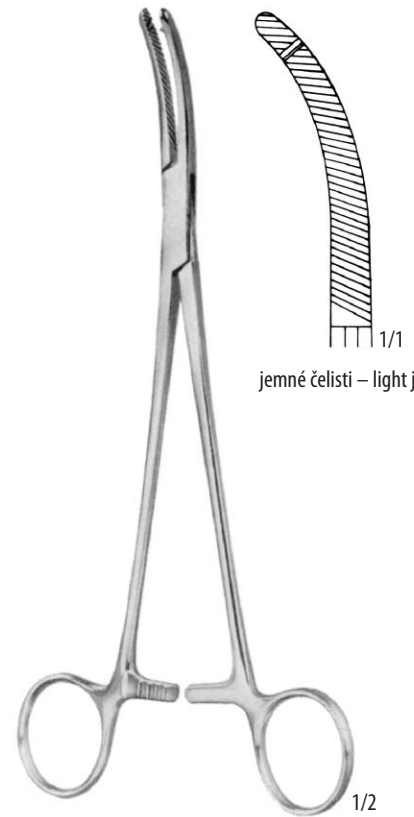

HEANEY
115 91 0286
21,0 cm

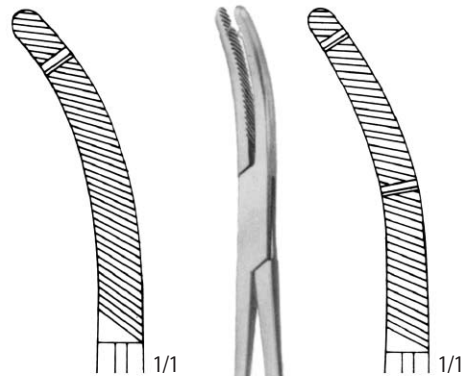

Original 21,0 cm

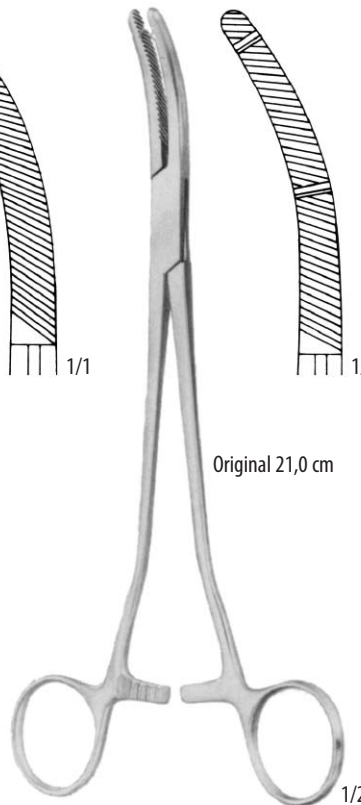

HEANEY

115 91 0287
115 91 0288

21,0 cm
23,0 cm

115 91 0289
115 91 0290

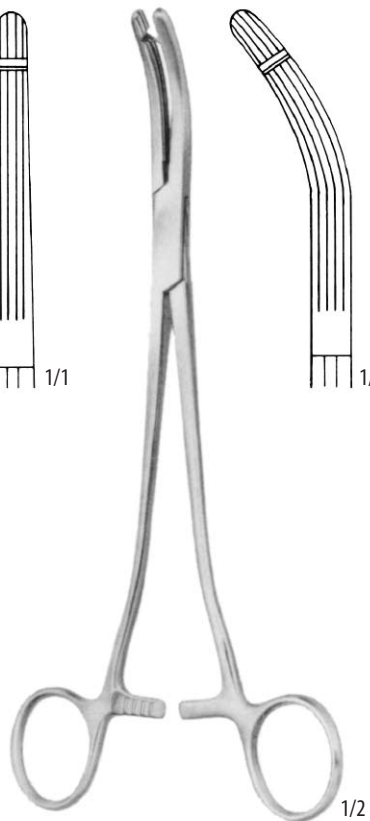
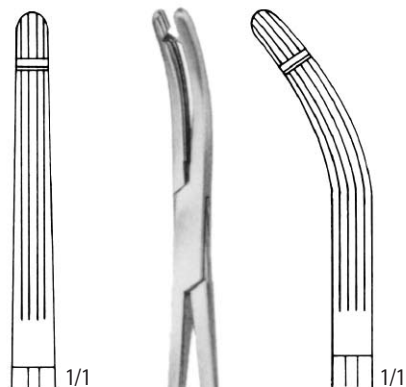
SVORKY NA HYSTEREKTOMII
HYSTERECTOMY CLAMP-FORCEPS

HEANEY-BALANTINE
115 91 0291 21,0 cm **115 91 0292**

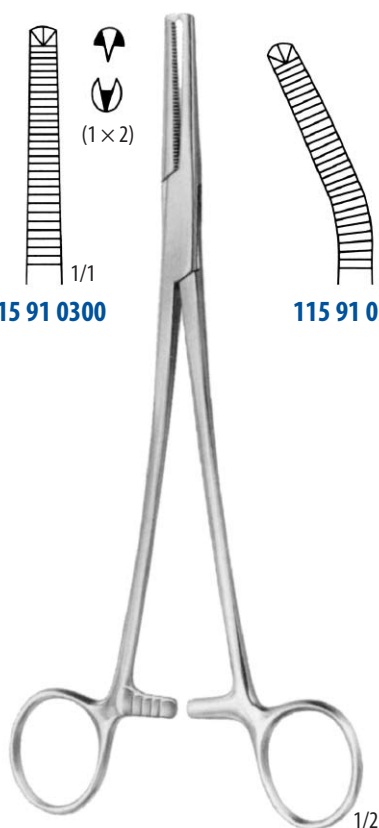
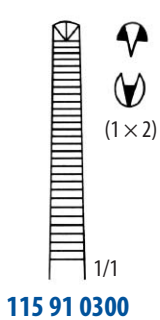

PHANEUF
 21,5 cm

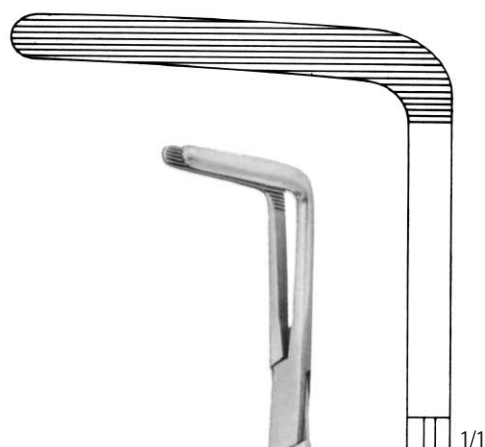

WERTHEIM-CULLEN
115 91 0299
 21,5 cm

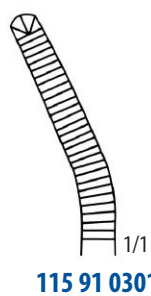

115 91 0301



115 19 0010
20,0 cm

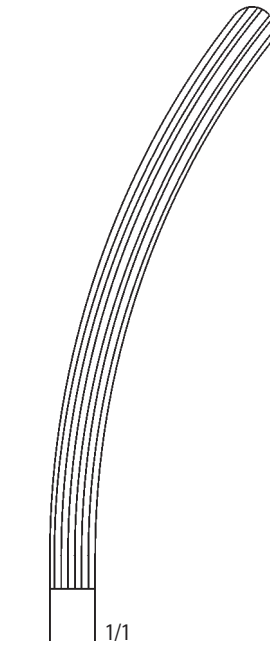

115 19 0020
20,0 cm



115 19 0070
24,0 cm

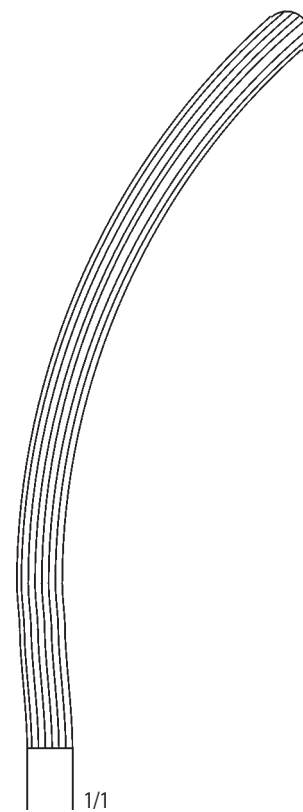

115 19 0080
24,0 cm

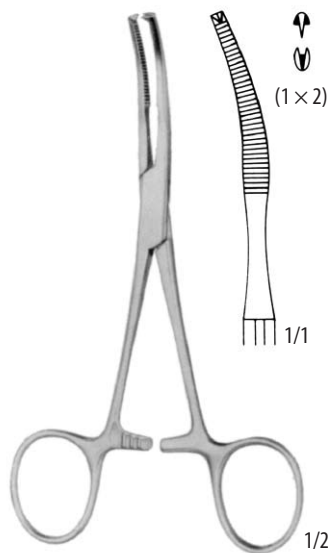
SVORKY NA POBŘÍŠNICI
PERITONEAL CLAMP-FORCEPS
**BABY-MIKULICZ****115 91 0322**

14,0 cm

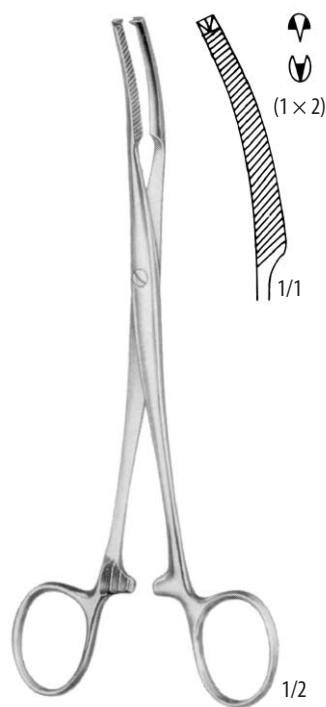
**MIKULICZ****115 27 0070**

18,0 cm

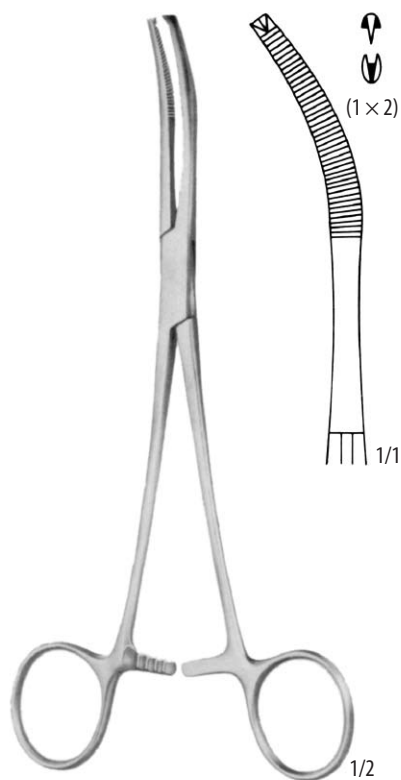
**MIKULICZ****115 91 0326**

20,0 cm

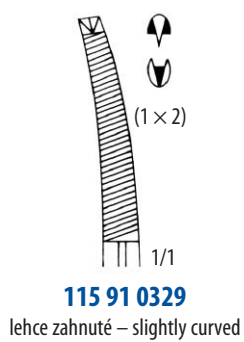
**115 91 0329**

lehce zahnuté – slightly curved

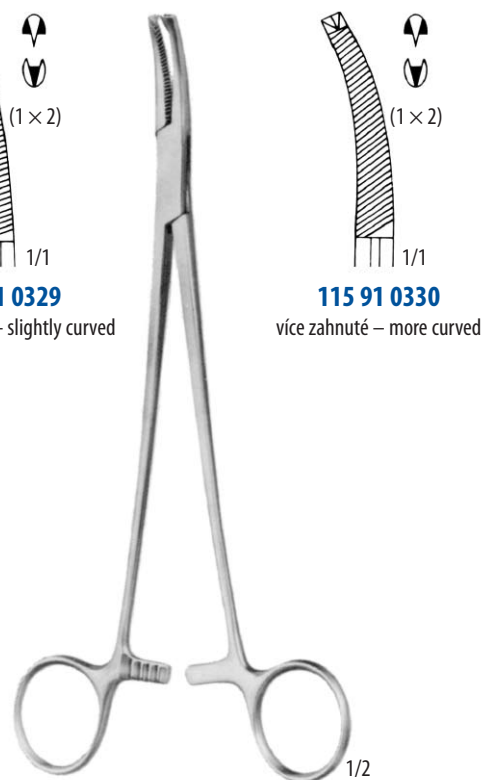
**115 91 0330**

více zahnuté – more curved

FAURE

20,0 cm



PARAMETRIUM
21,0 cm

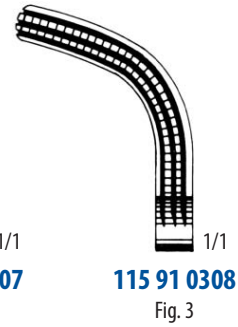
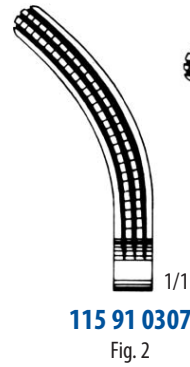
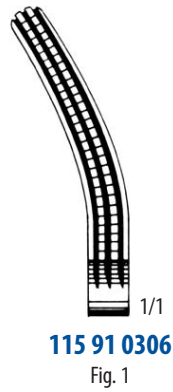
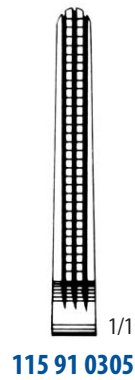

PARAMETRIUM
24,0 cm

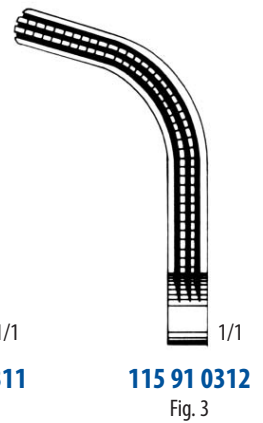
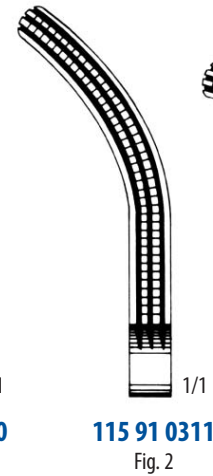
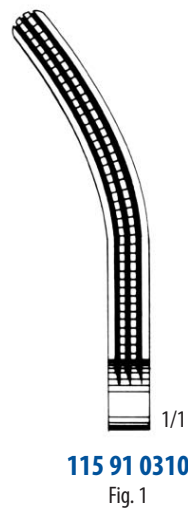
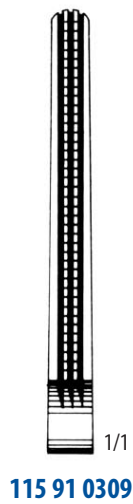

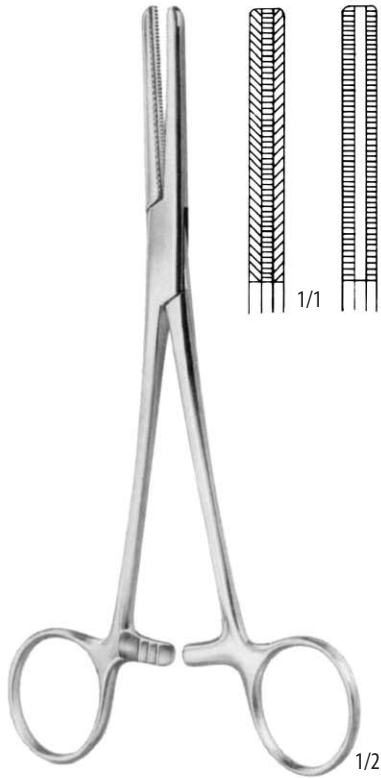

FERGUSSON
115 91 0313
16,0 cm

115 91 0314
20,0 cm

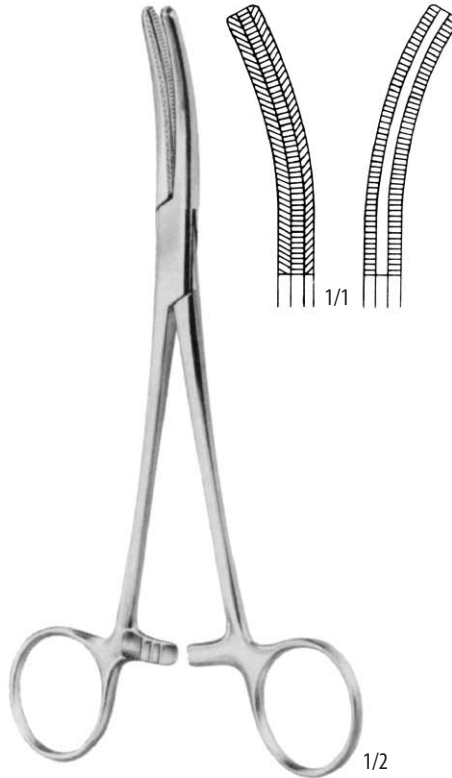

FERGUSSON
115 91 0315
16,0 cm

115 91 0316
20,0 cm



PRATT
115 91 0317
15,0 cm



DE BAKEY

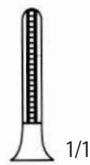
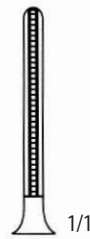
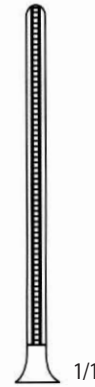
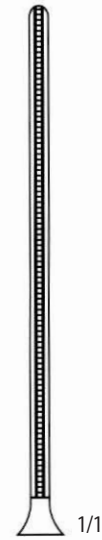

DE BAKEY

 115 91 0600
 7,5 cm

 115 91 0601
 8,5 cm

 115 91 0602
 10,5 cm

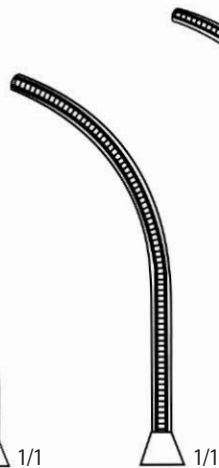
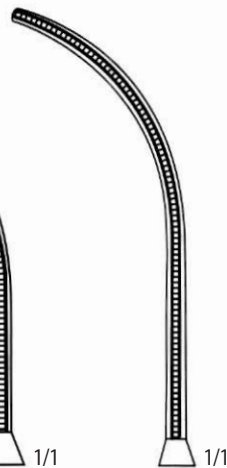
 115 91 0603
 12,0 cm

DE BAKEY

 115 91 0604
 7,0 cm

 115 91 0605
 8,0 cm

 115 91 0606
 10,0 cm

 115 91 0607
 11,5 cm

 SANTULLI
 115 91 0608
 7,0 cm

1/1

SVORKY ATRAUMATICKÉ NA CÉVY
 ARTERY FORCEPS ATRAUMATIC JAWS

DE BAKEY



GLOVER

115 91 0609
 6,0 cm

115 91 0610
 7,0 cm

115 91 0611
 9,0 cm

115 91 0612
 11,0 cm

GLOVER

115 91 0613
 5,5 cm

115 91 0614
 6,5 cm

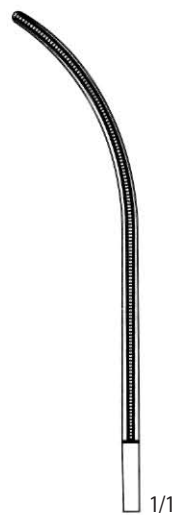
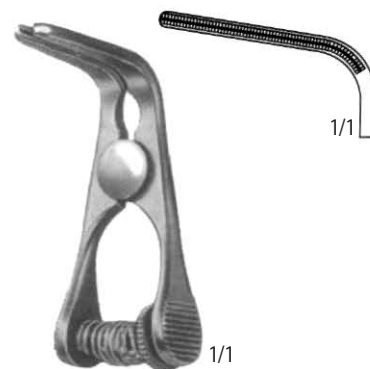
115 91 0615
 8,5 cm

115 91 0616
 10,5 cm

GLOVER
115 91 0617
 5,0 cm

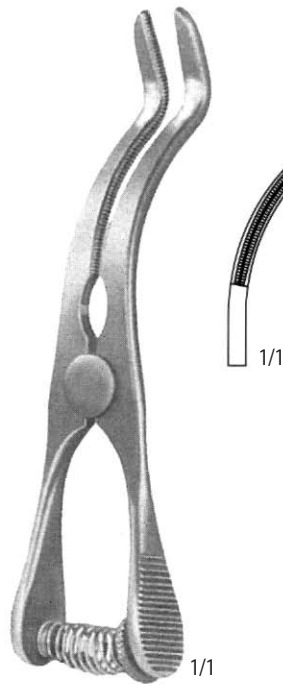

DE BAKEY

DE BAKEY-SATINSKY
115 91 0618

7,0 cm

DE BAKEY-CAROTIS
115 91 0619

9,0 cm

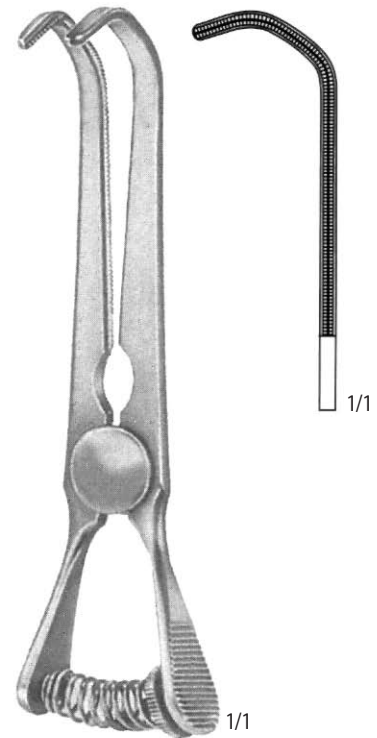
DE BAKEY-SATINSKY
115 91 0620

10,0 cm

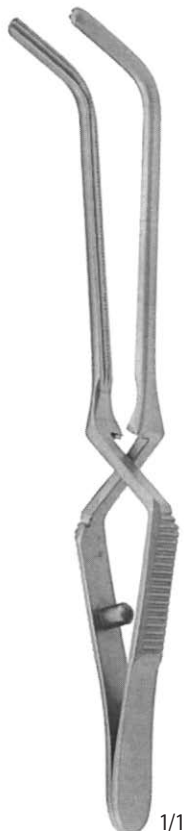
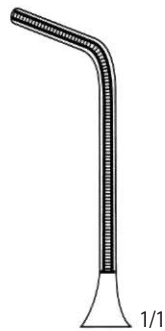
GREGORY-SOFT

115 91 0621

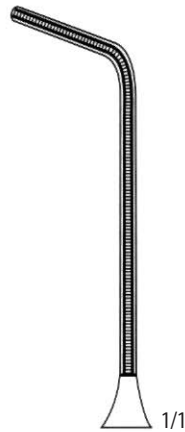
9,0 cm

115 91 0622

11,0 cm



115 91 0623

11,0 cm

115 91 0624

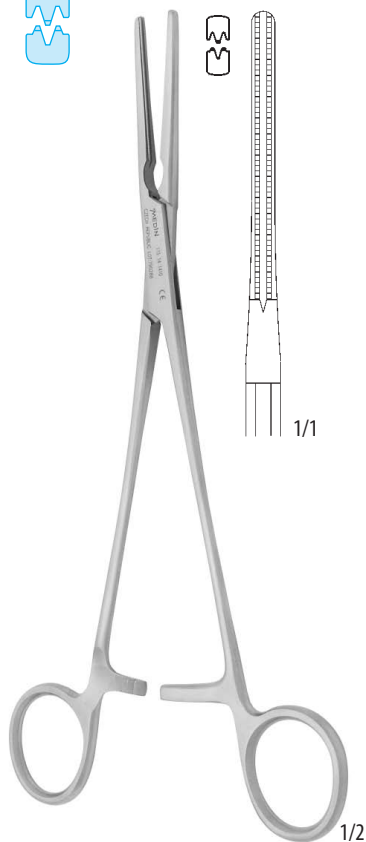
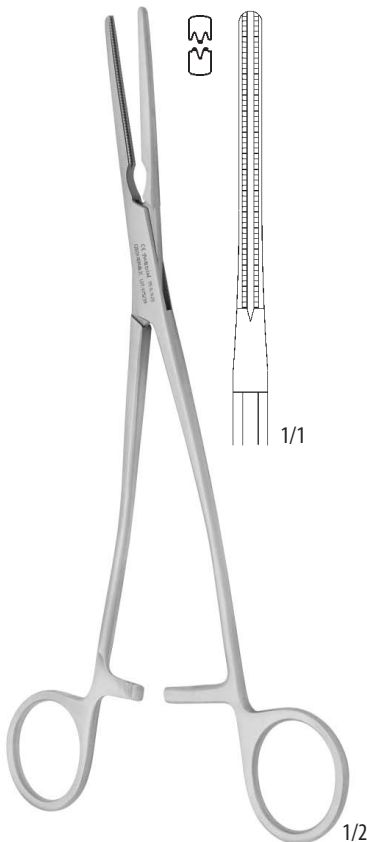
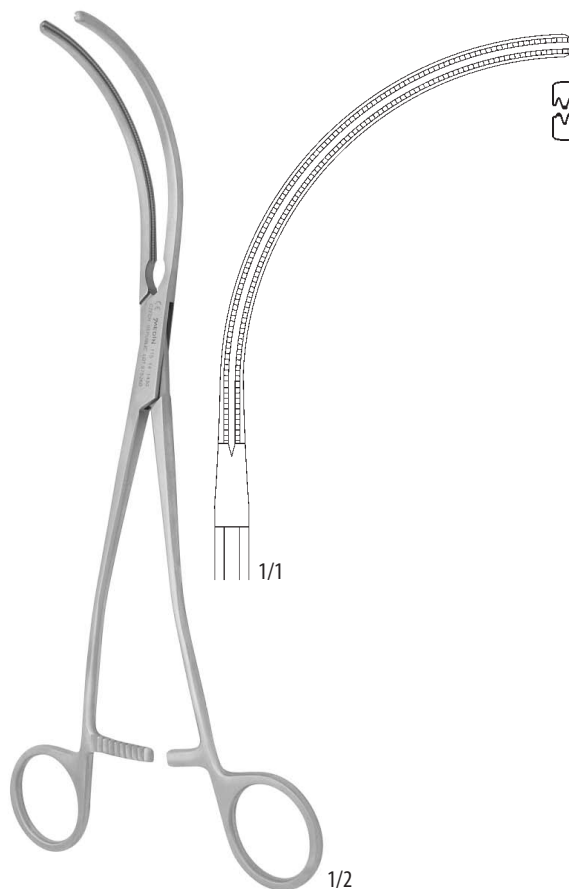
11,0 cm

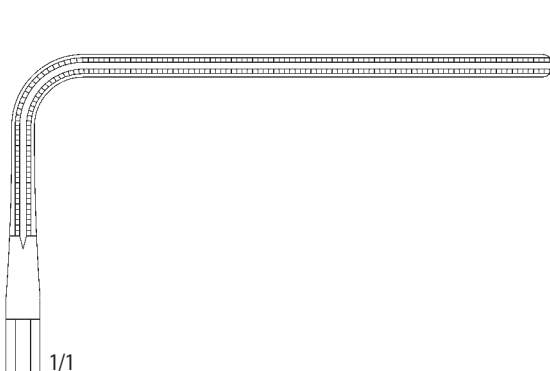
SVORKY ATRAUMATICKÉ NA CÉVY
ARTERY FORCEPS ATRAUMATIC JAWS

115 14 1410
 22,0 cm

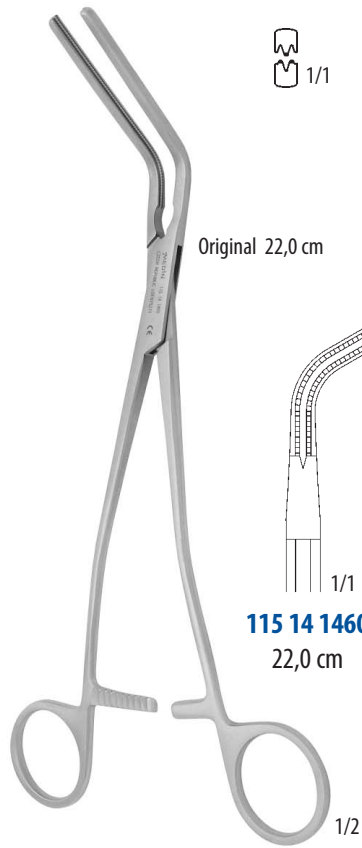
115 14 1420
 22,0 cm

115 14 1430
 23,5 cm

115 14 1440
 20,5 cm

115 14 1450
 20,5 cm



115 14 1460
22,0 cm



115 14 1480
22,4 cm



SVORKY ATRAUMATICKÉ NA CÉVY
 ARTERY FORCEPS ATRAUMATIC JAWS

DE BAKEY

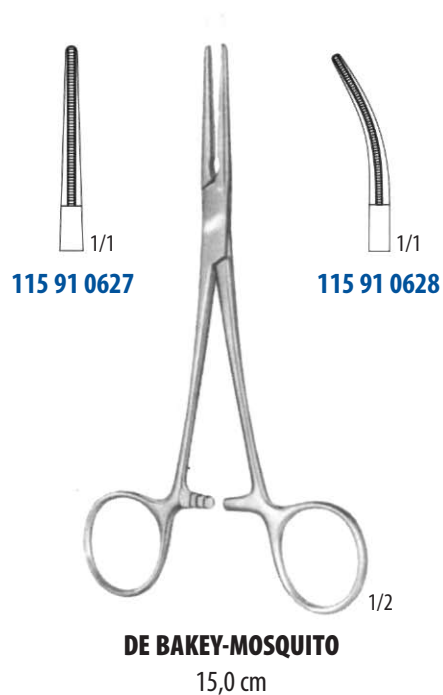



DE BAKEY



DE BAKEY-PEAN

1/2

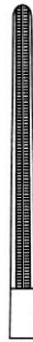

1/1

115 91 0591

14,0 cm



1/1

115 91 0630

16,0 cm



1/1

115 91 0631

18,0 cm



1/1

115 91 0597

20,0 cm



1/1

115 91 0592

14,0 cm



1/1

115 91 0632

16,0 cm



1/1

115 91 0633

18,0 cm



1/1

115 91 0634

20,0 cm

SVORKY ATRAUMATICKÉ NA CÉVY
 ARTERY FORCEPS ATRAUMATIC JAWS

DE BAKÉY

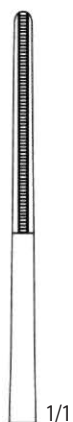

1/1

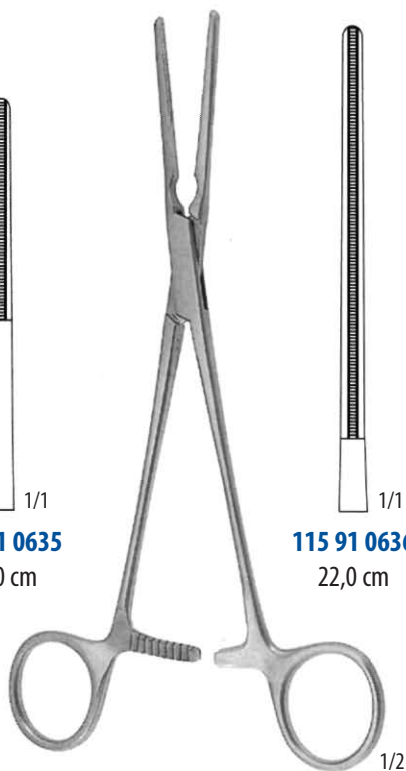
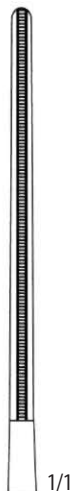
115 91 0635
 21,0 cm
**POTTS**

1/1

115 91 0636
 22,0 cm
**POTTS**

1/1

115 91 0637
 21,0 cm

1/1

115 91 0638
 22,0 cm
**POTTS**
115 91 0639
 21,0 cm

1/1

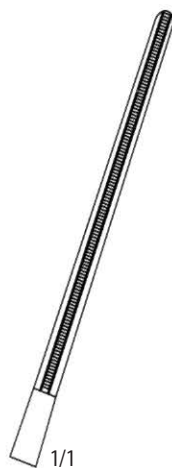

1/1

115 91 0640
 22,0 cm

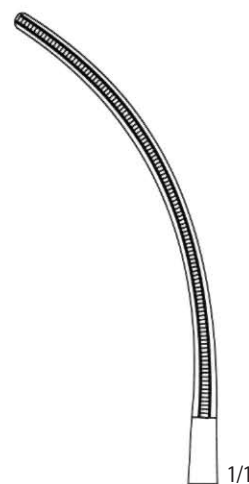
POTTS
 22,0 cm

1/1

115 91 0641

1/1

115 91 0642



DE BAKEY



DE BAKEY

1/2

115 91 0643
19,0 cm

1/1

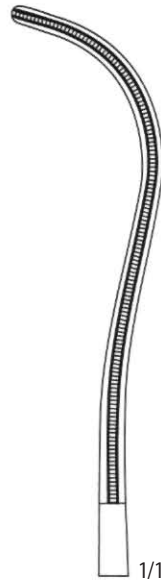

1/1

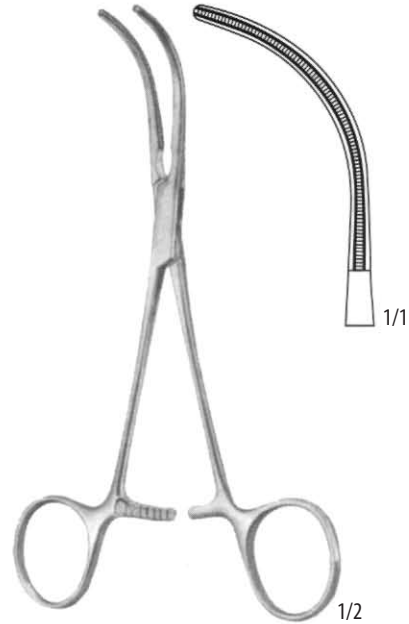
115 91 0644
23,0 cm

DE BAKEY

1/2

115 91 0645
16,0 cm

1/1

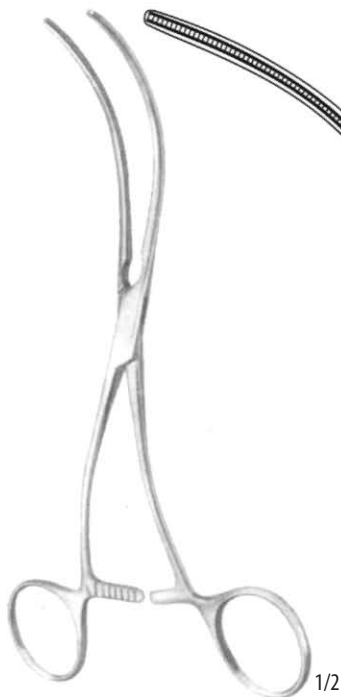

DE BAKEY

1/2

115 91 0646
19,0 cm

1/1

115 91 0490
20,0 cm

1/1

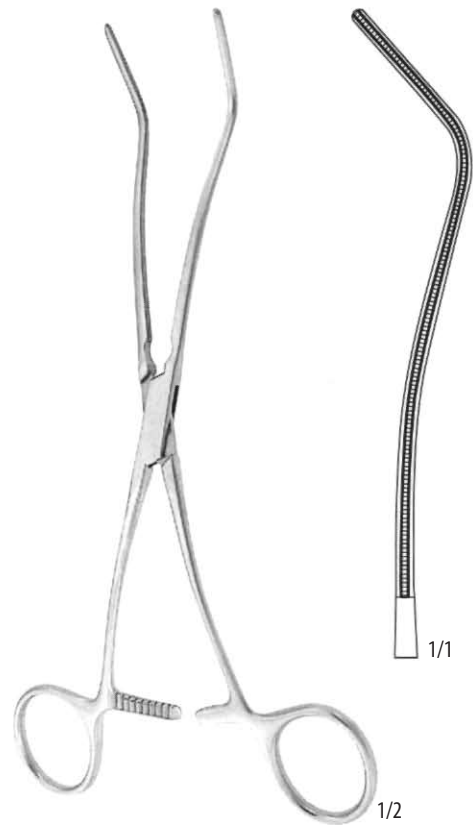

DE BAKEY

1/2

115 91 0647
20,0 cm

1/1

SVORKY ATRAUMATICKÉ NA CÉVY
ARTERY FORCEPS ATRAUMATIC JAWS

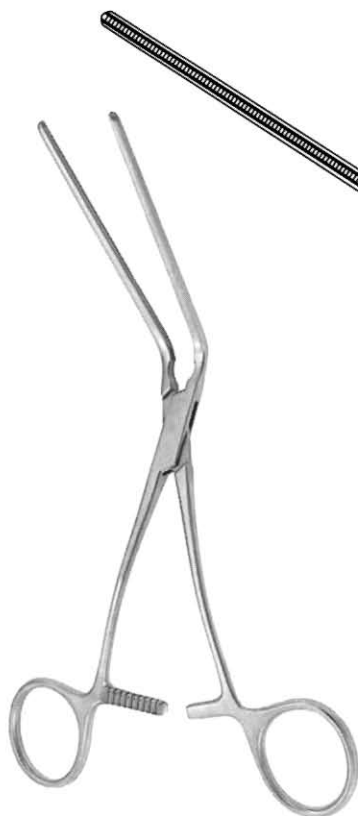
DE BAKY

1/2

LELAND-JONES

1/2

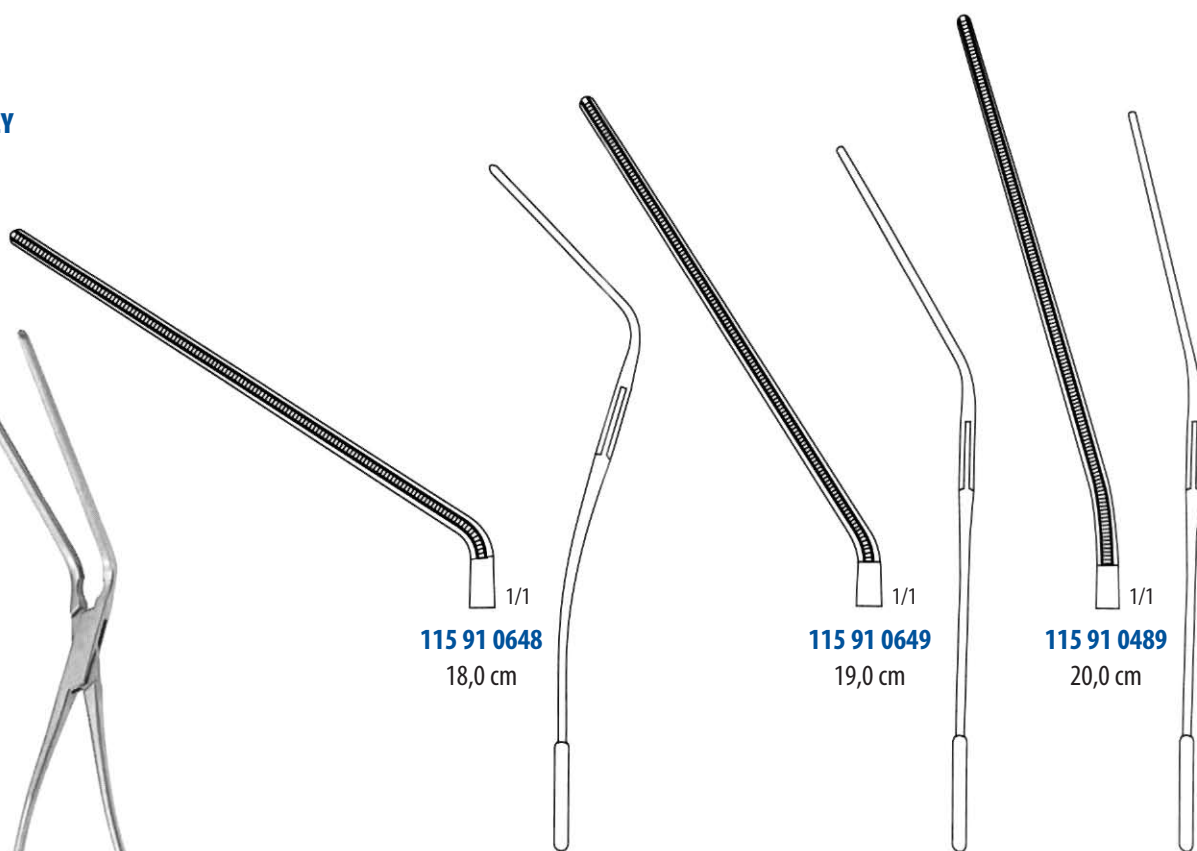
BAINBRIDGE

115 91 0648
18,0 cm

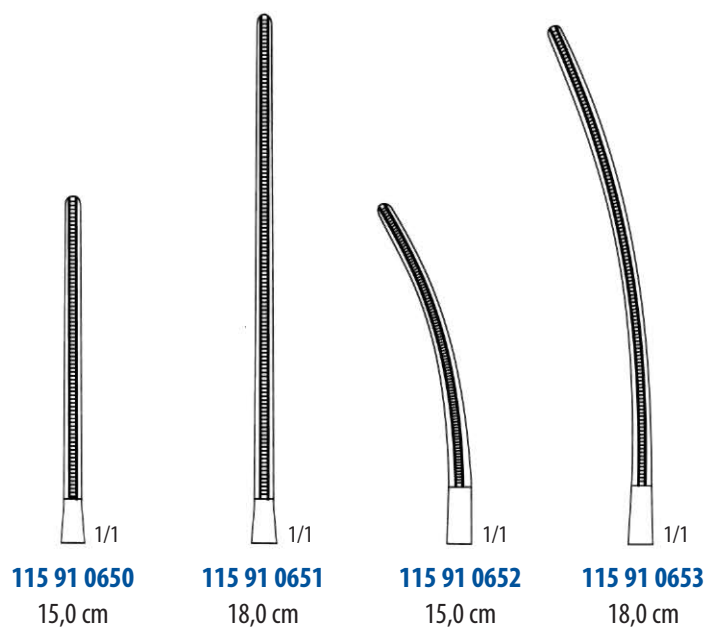
115 91 0649
19,0 cm

115 91 0489
20,0 cm

115 91 0650
15,0 cm

115 91 0651
18,0 cm

115 91 0652
15,0 cm

115 91 0653
18,0 cm



DE BAKEY



SVORKY ATRAUMATICKÉ NA CÉVY
 ARTERY FORCEPS ATRAUMATIC JAWS



DE BAKEY

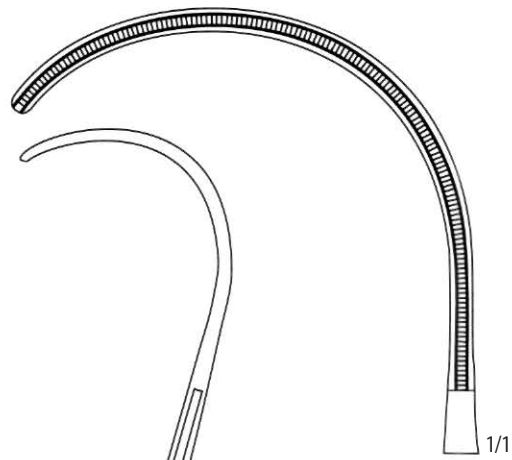
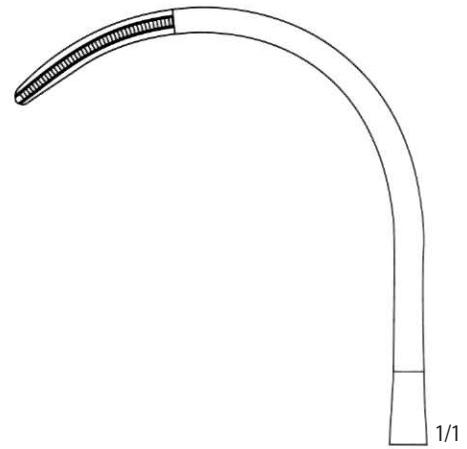

DE BAKEY

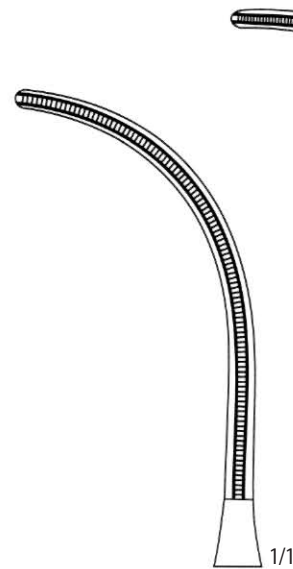
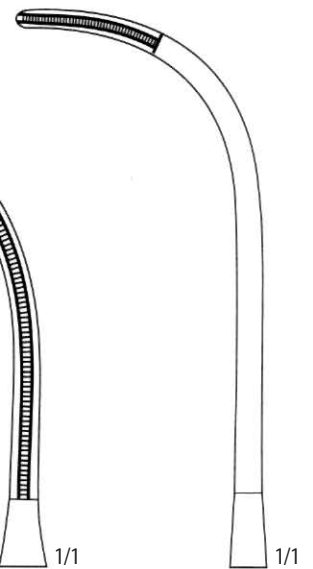

 115 91 0658
 25,0 cm

 115 91 0659
 26,0 cm

DE BAKEY

 115 91 0660
 24,0 cm

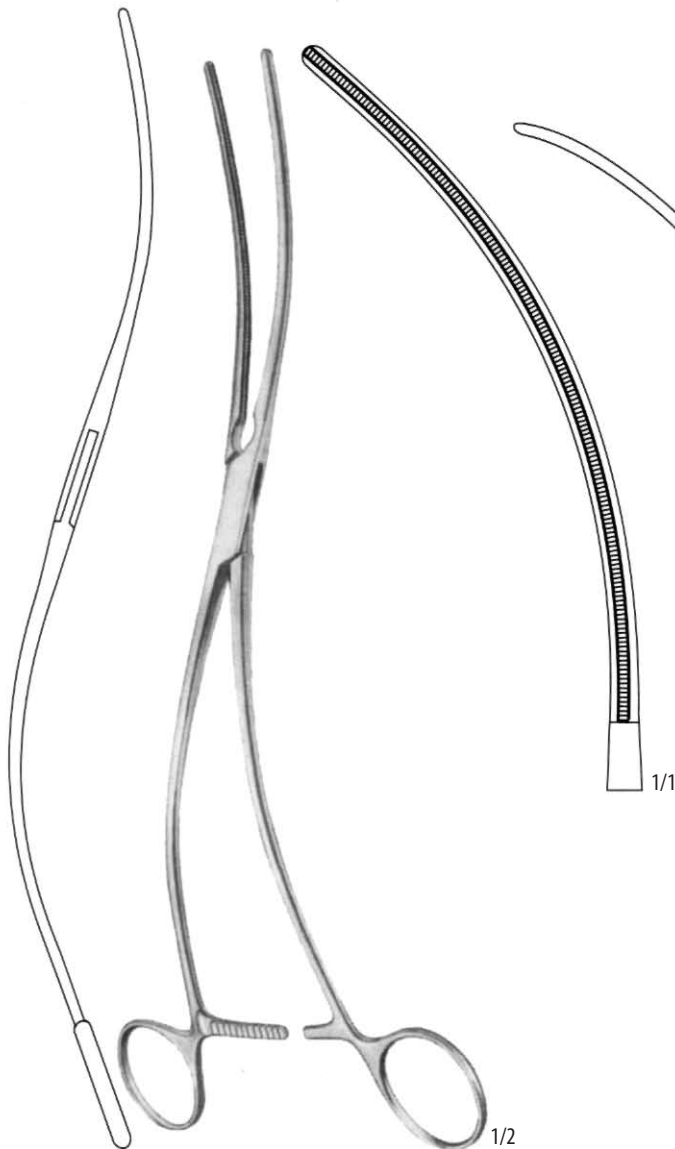
 115 91 0661
 24,0 cm



DE BAKEY



DE BAKEY
115 91 0662
30,0 cm

1/2

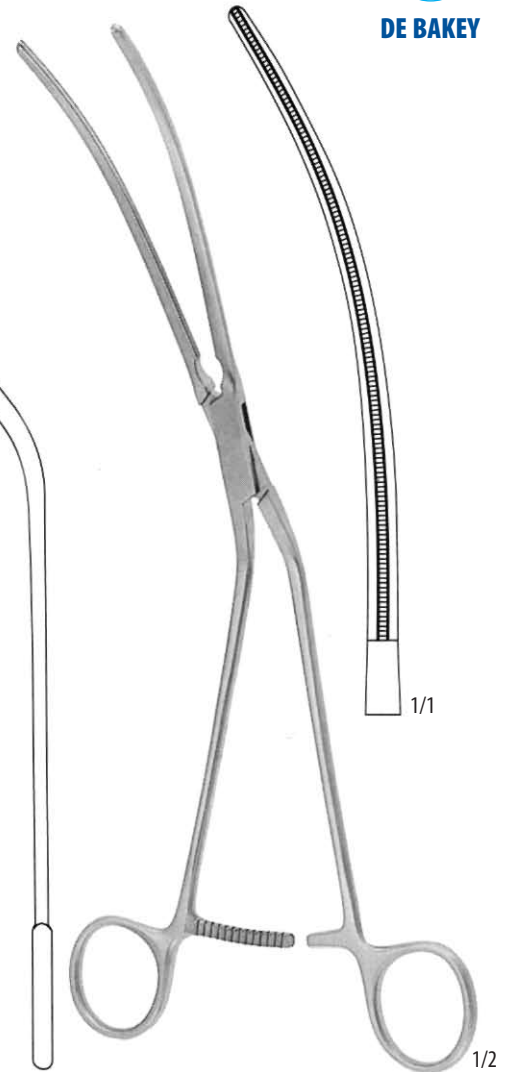

DE BAKEY
115 91 0663
28,0 cm

1/2

SVORKY ATRAUMATICKÉ NA CÉVY
 ARTERY FORCEPS ATRAUMATIC JAWS

DE BAKEY

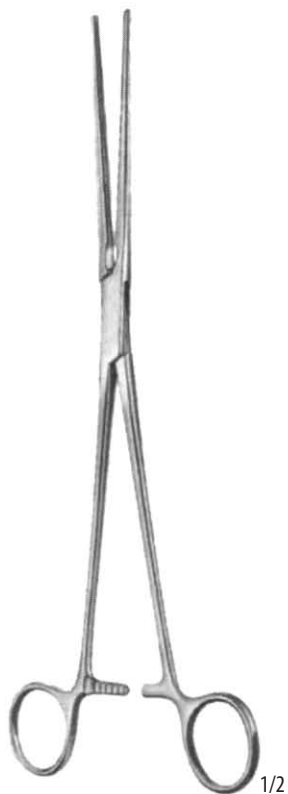

DE BAKEY

1/2

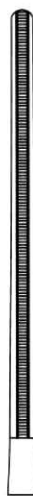

1/1

115 91 0664

21,0 cm

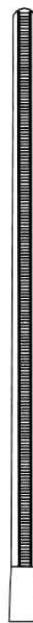

1/1

115 91 0665

23,0 cm



1/1

115 91 0666

27,0 cm



1/1

115 91 0667

31,0 cm

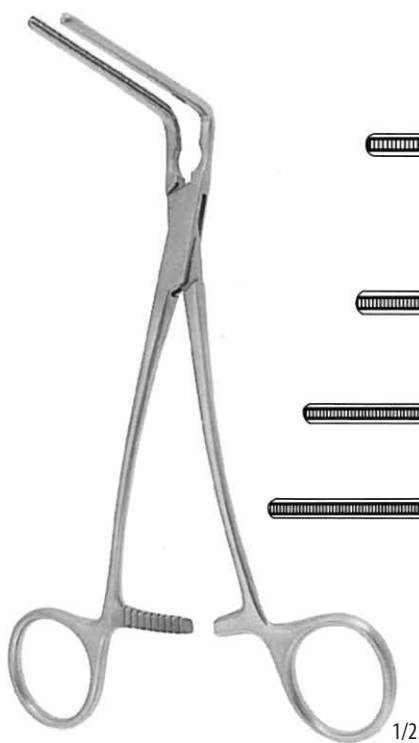

DE BAKEY



115 91 0668

18,0 cm

115 91 0669

19,0 cm

115 91 0670

23,0 cm

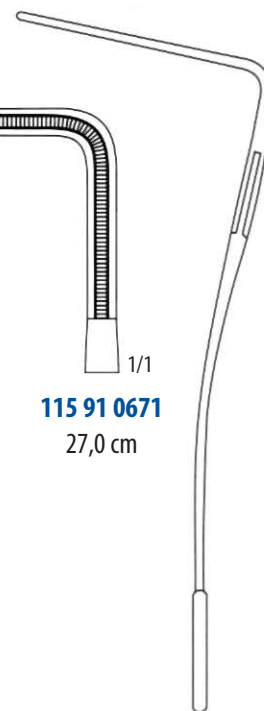

115 91 0671

27,0 cm



DE BAKEY



DE BAKEY

1/2

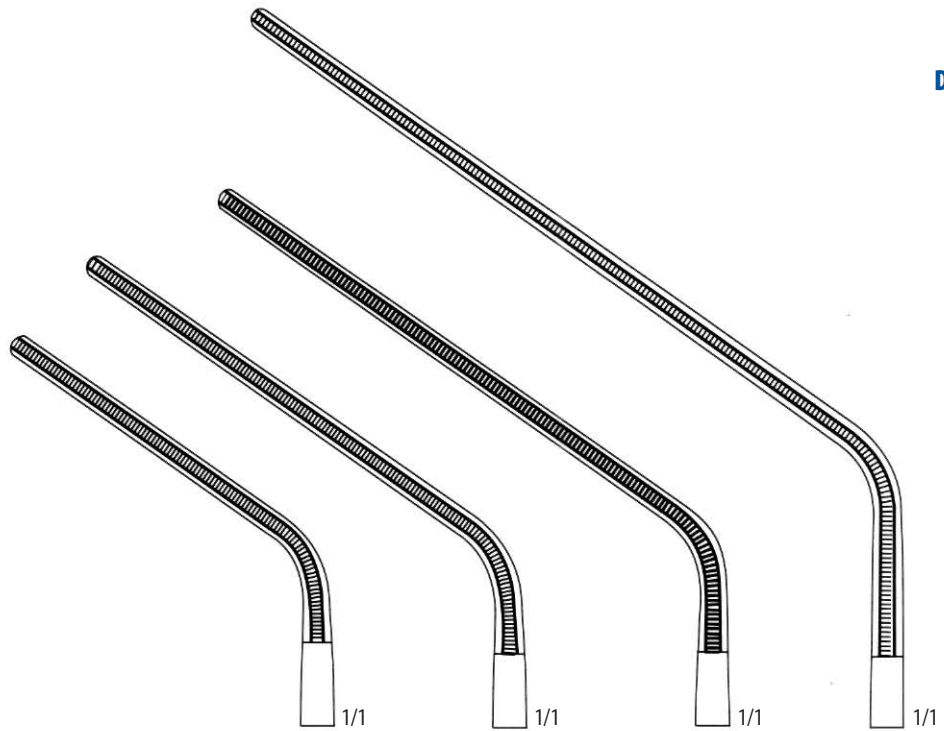
 115 91 0672
 20,0 cm

 115 91 0598
 21,0 cm

 115 91 0673
 25,0 cm

 115 91 0674
 29,0 cm

DE BAKEY

1/2

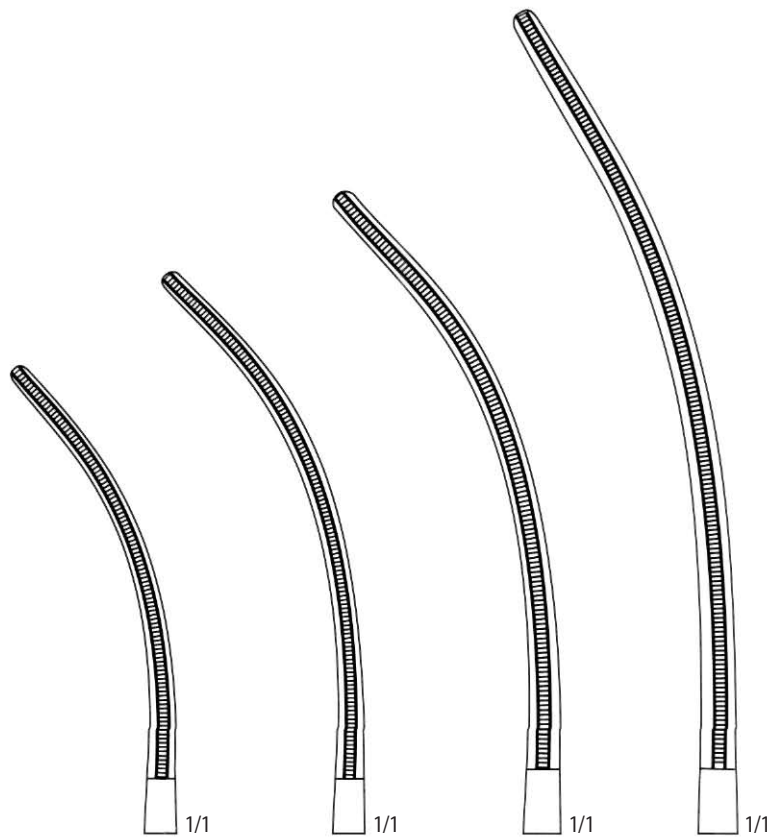

 115 91 0675
 21,5 cm

 115 91 0676
 23,0 cm

 115 91 0677
 27,0 cm

 115 91 0678
 31,0 cm

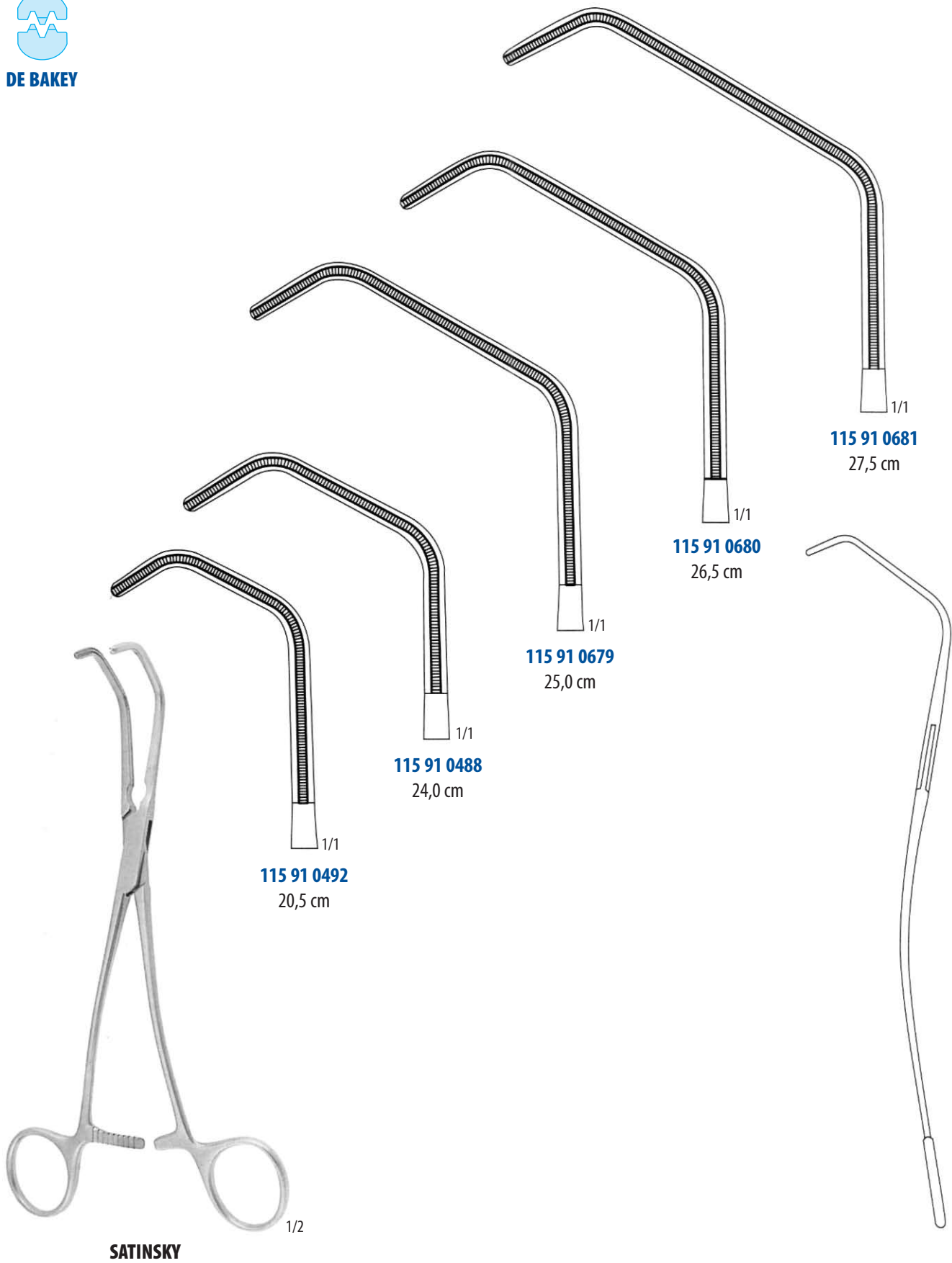
SVORKY ATRAUMATICKÉ NA CÉVY
ARTERY FORCEPS ATRAUMATIC JAWS

DE BAKEY



DE BAKÉY



LAMBERT-KAY

1/2

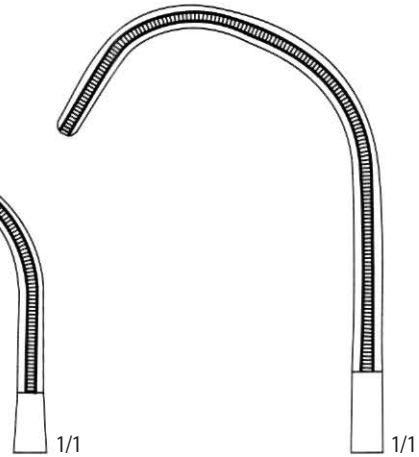
 115 91 0682
 21,0 cm

 115 91 0683
 21,0 cm

DE BAKÉY

1/2

 115 91 0684
 17,0 cm

1/1

1/2



DE BAKÉY-BAHNSON

1/2

 115 91 0685
 23,0 cm

1/1

 115 91 0686
 24,0 cm

1/1

 115 91 0687
 25,0 cm

1/1



DE BAKEY



HARKEN

1/2

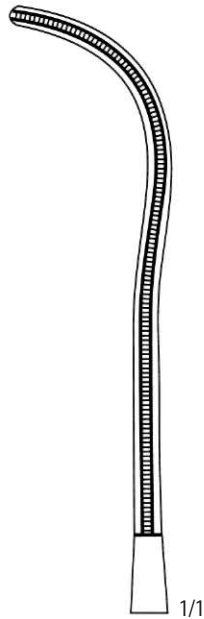

115 91 0688

24,0 cm

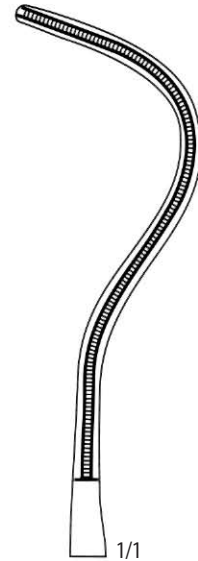

115 91 0689

24,0 cm

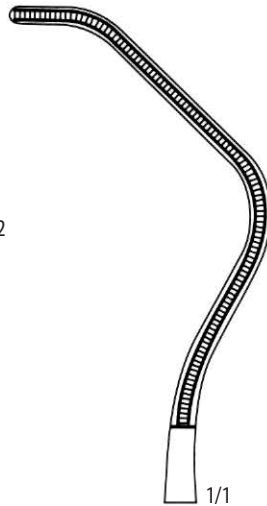

115 91 0690

24,0 cm

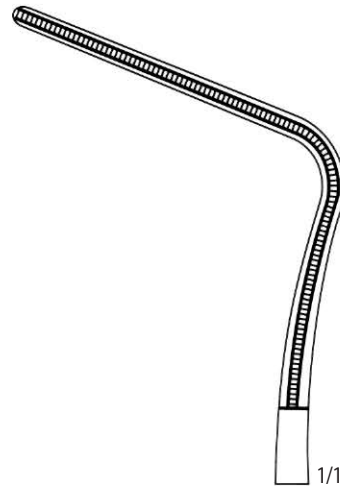

115 91 0691

24,0 cm



DE BAKÉY

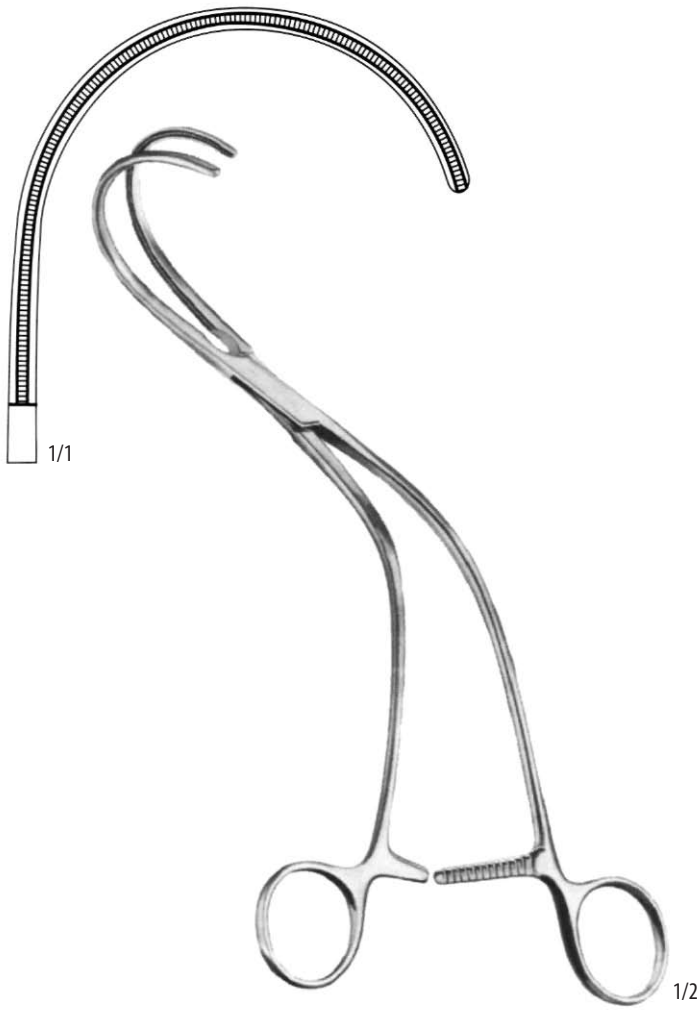

WEBER
115 91 0692
26,0 cm

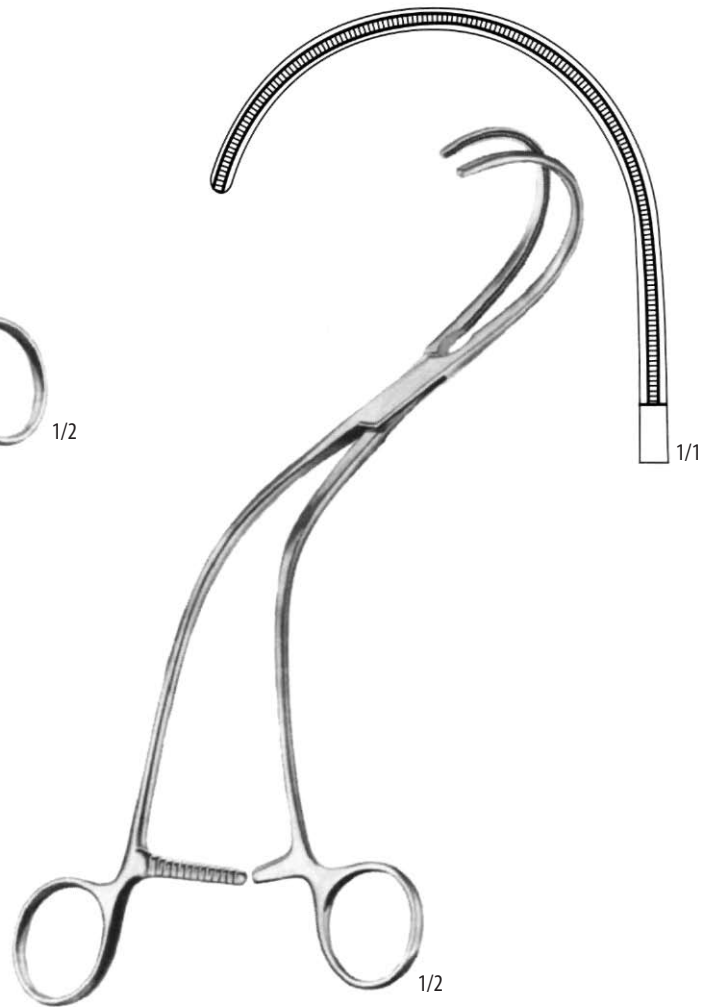

WEBER
115 91 0693
26,0 cm

SVORKY ATRAUMATICKÉ NA CÉVY
 ARTERY FORCEPS ATRAUMATIC JAWS

DE BAKEY

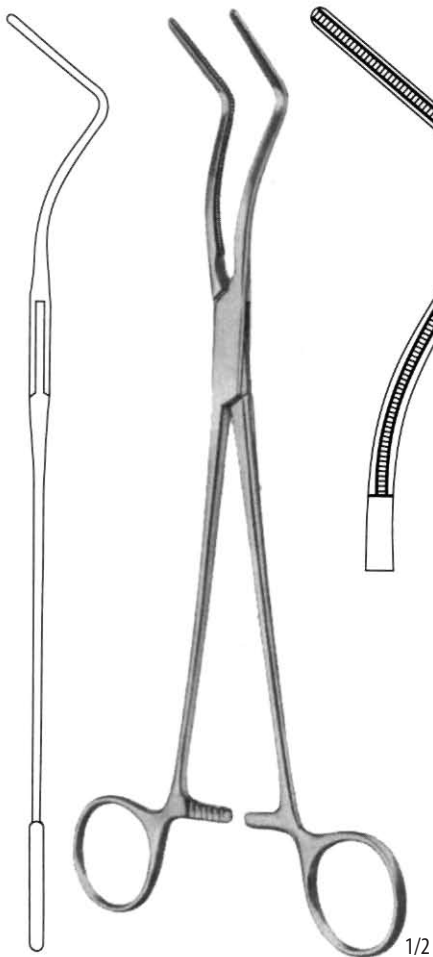

LEES
115 91 0694
 25,0 cm

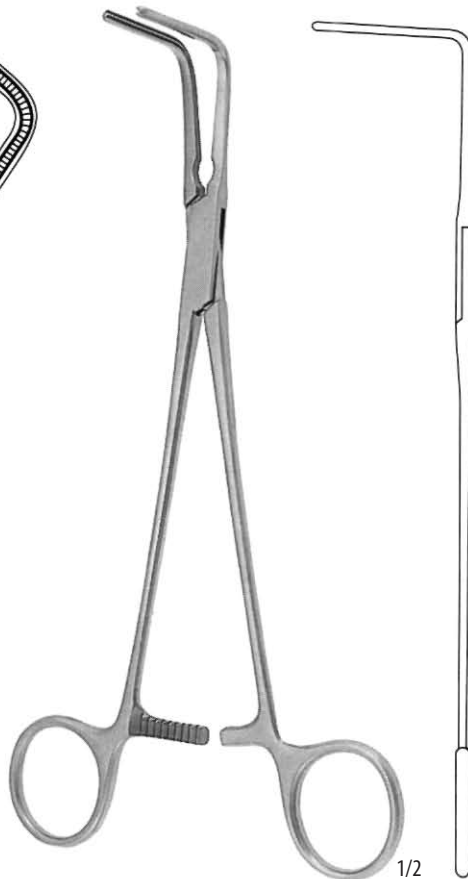

LEES



115 91 0599
 23,0 cm

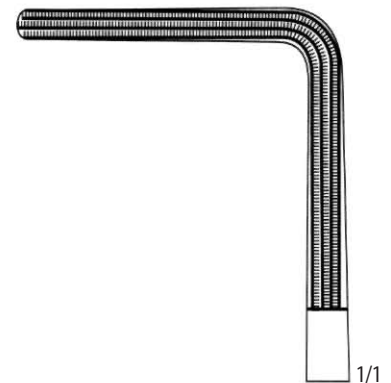

115 91 0695
 25,0 cm



DE BAKEY



DE BAKEY
115 91 0696
27,0 cm

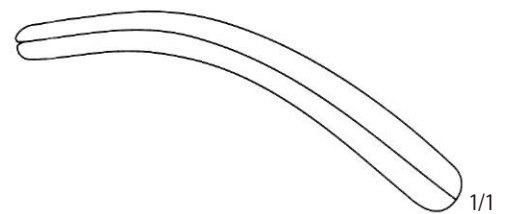
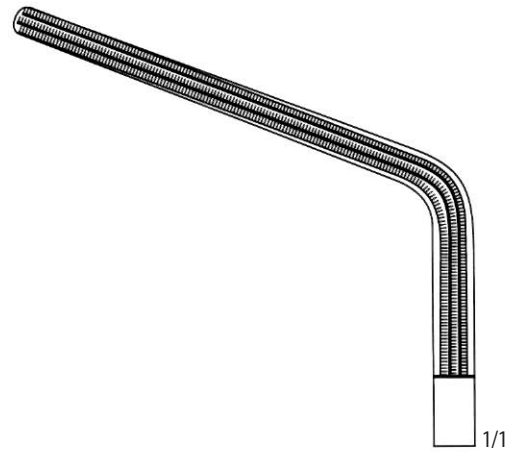

horní pohled – top view

SVORKY ATRAUMATICKÉ NA CÉVY
 ARTERY FORCEPS ATRAUMATIC JAWS

DE BAKEY

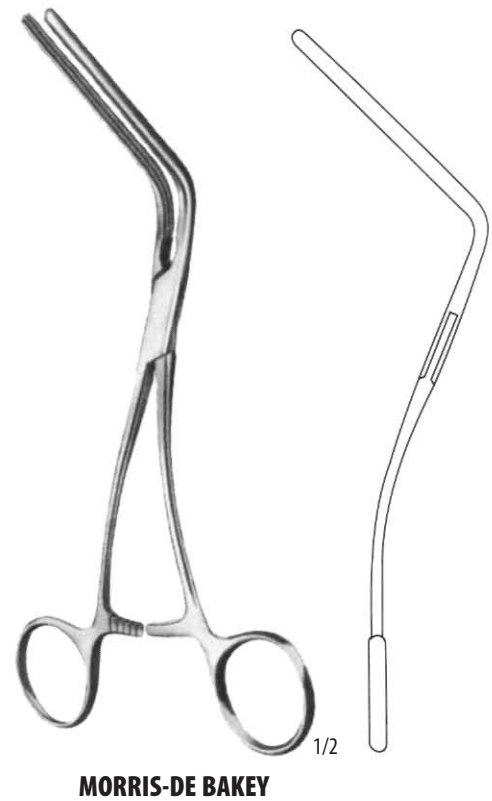
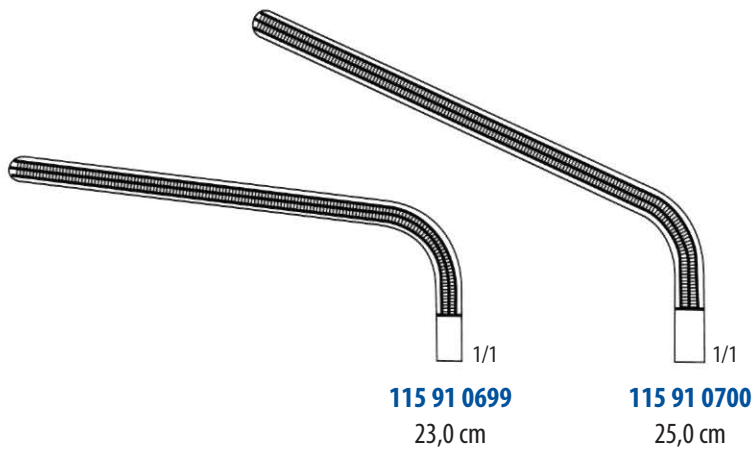
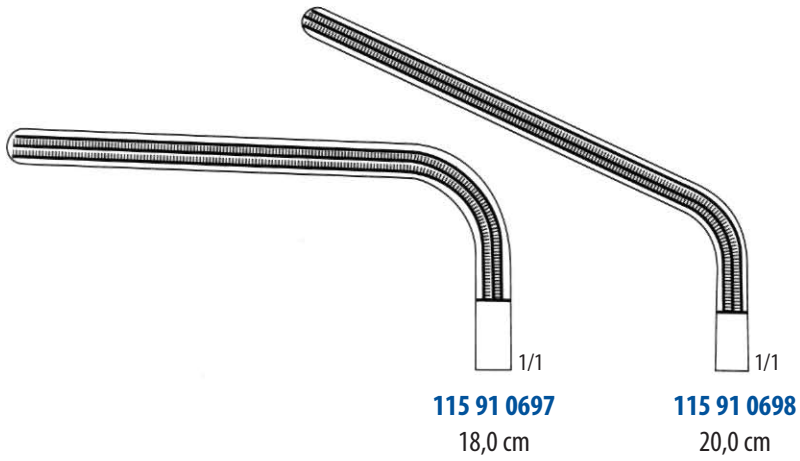



DE BAKÉY



OCHSNER
115 91 0701
 23,5 cm

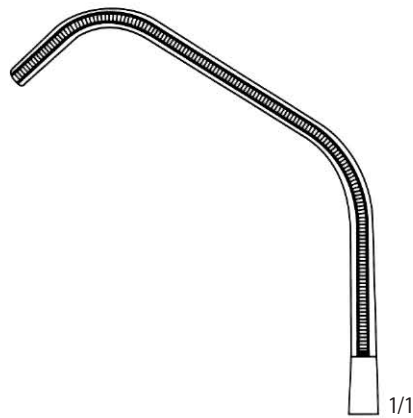

1/1

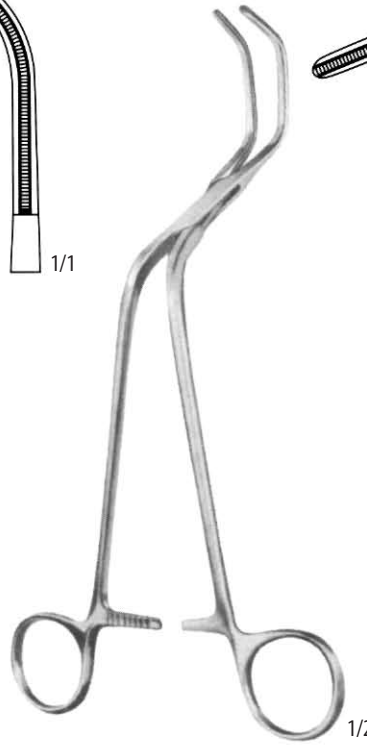

DIETRICH
115 91 0702
 21,0 cm

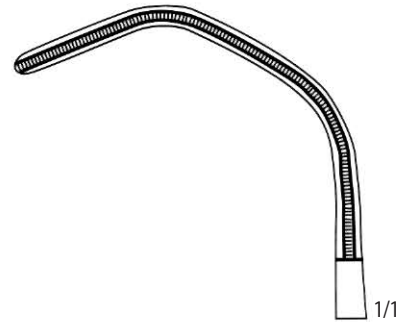

1/1



GREGORY

115 91 0703
 14,0 cm

1/1

115 91 0704
 16,0 cm

1/1

115 91 0705
 18,0 cm

1/1

SVORKY ATRAUMATICKÉ NA CÉVY
 ARTERY FORCEPS ATRAUMATIC JAWS

DE BAKEY



DALE

1/2



1/1

115 91 0706

17,0 cm

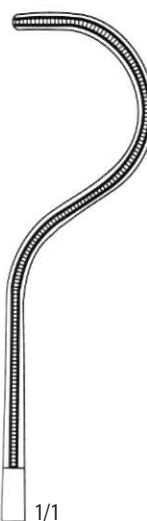

1/1

115 91 0707

18,0 cm

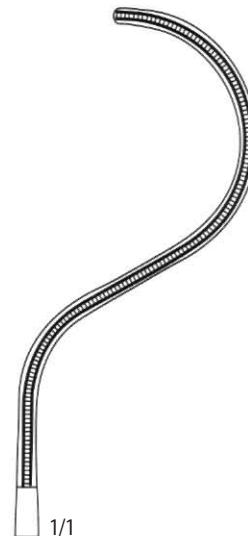

1/1

115 91 0708

18,5 cm

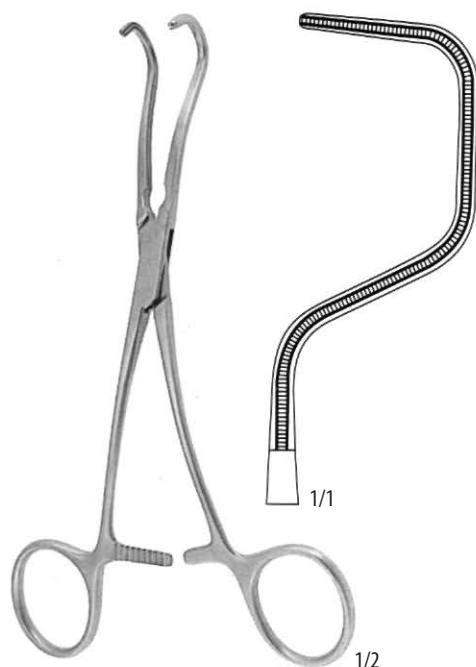

DALE

115 91 0709

18,5 cm

1/1

1/2



DERRA

1/1

115 91 0710

16,0 cm

1/1

115 91 0711

17,0 cm

1/1

115 91 0712

18,0 cm

1/2



DE BAKEY



1/2

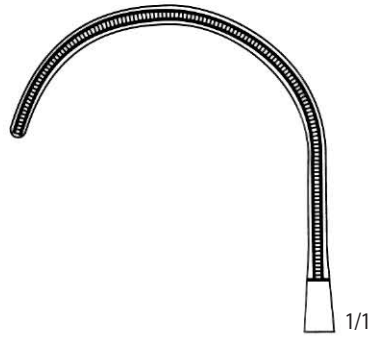

1/1

115 91 0713

16,0 cm

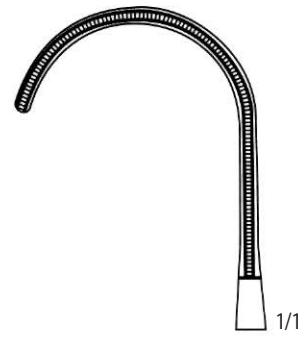

1/1

115 91 0714

17,0 cm



1/2

BECK
115 91 0715
17,0 cm

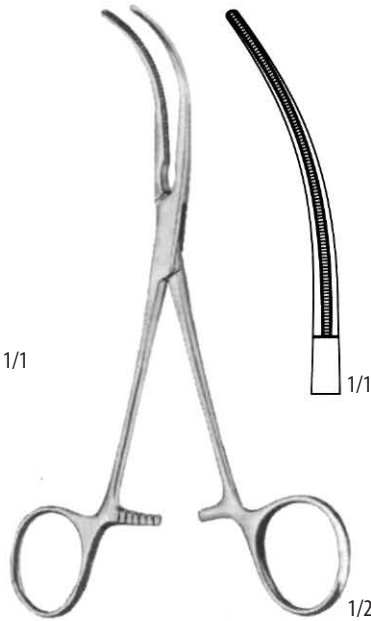

1/2

GLOVER
115 91 0716
17,0 cm

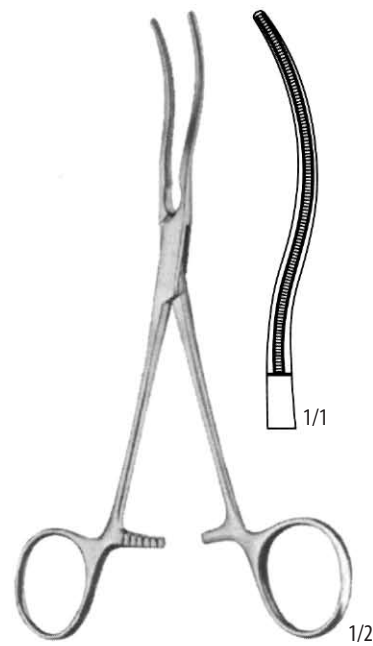

1/2

GLOVER
115 91 0717
17,0 cm

SVORKY ATRAUMATICKÉ NA CÉVY
 ARTERY FORCEPS ATRAUMATIC JAWS

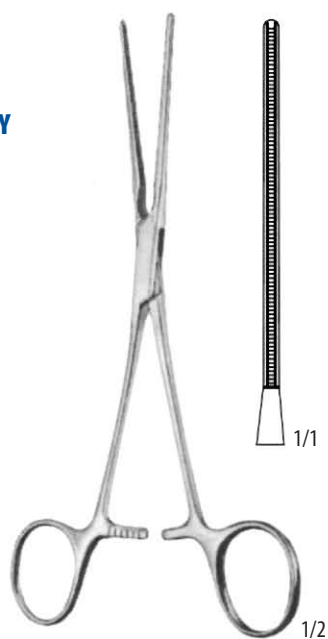

DE BAKEY

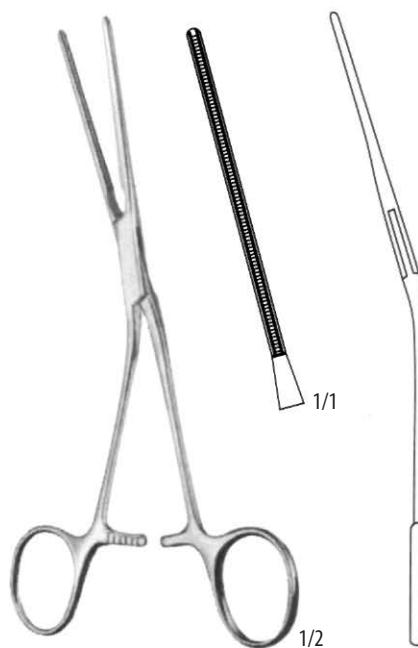

DE BAKEY
115 91 0718
 17,0 cm

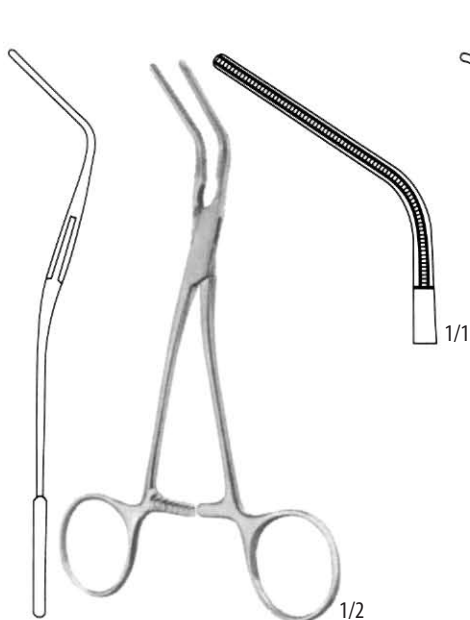

DE BAKEY
115 91 0719
 17,0 cm



DE BAKEY
115 91 0720
 15,0 cm

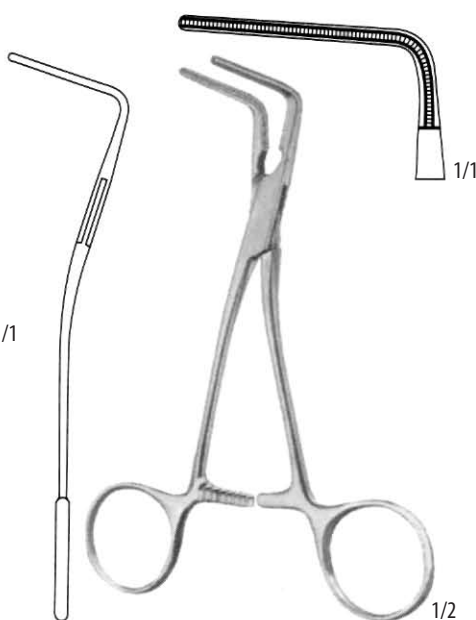

DE BAKEY
115 91 0721
 15,0 cm

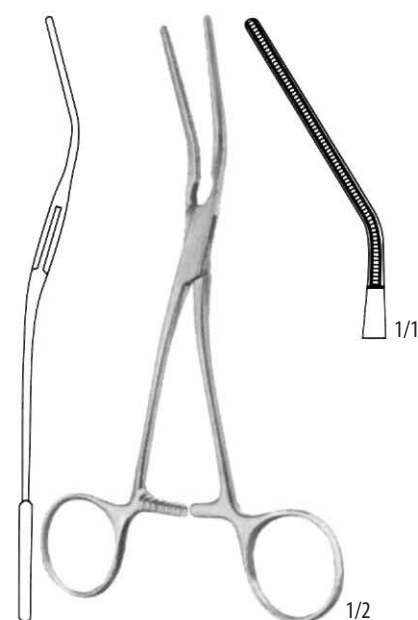

DE BAKEY
115 91 0722
 16,0 cm

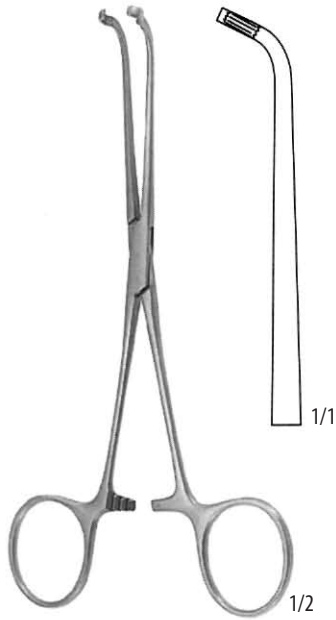

JAVID
115 91 0723
 18,0 cm

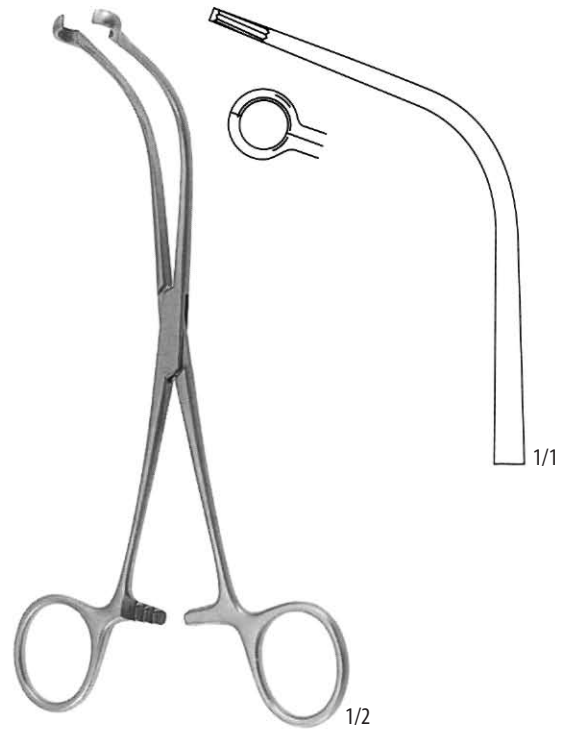

JAVID
115 91 0724
 19,0 cm

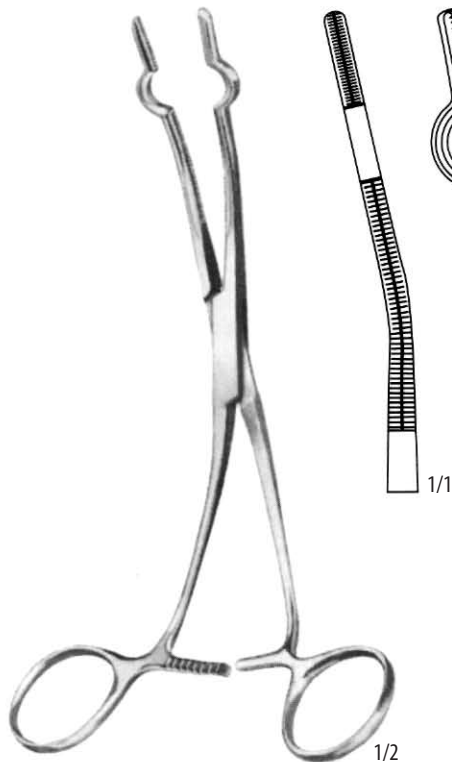

COOLEY

115 91 0725	16,0 cm	24 Ch
115 91 0726	16,0 cm	26 Ch
115 91 0727	20,0 cm	28 Ch
115 91 0728	20,0 cm	30 Ch
115 91 0729	20,0 cm	32 Ch
115 91 0730	20,0 cm	36 Ch



COOLEY

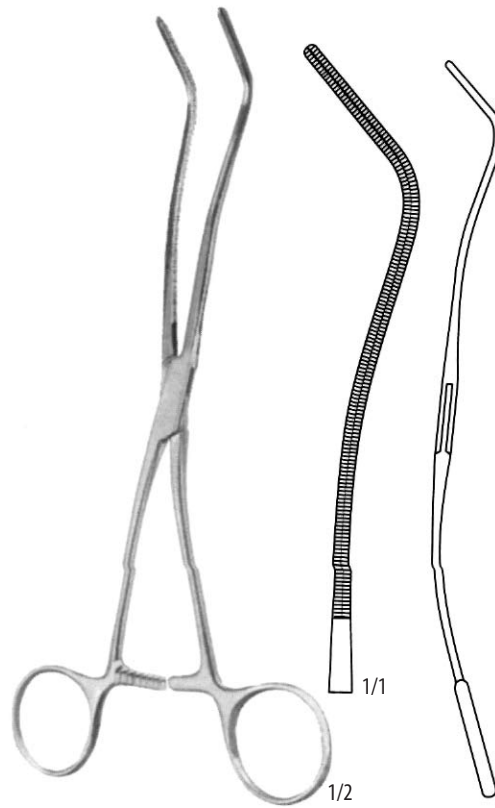

COOLEY
115 91 0731
20,0 cm

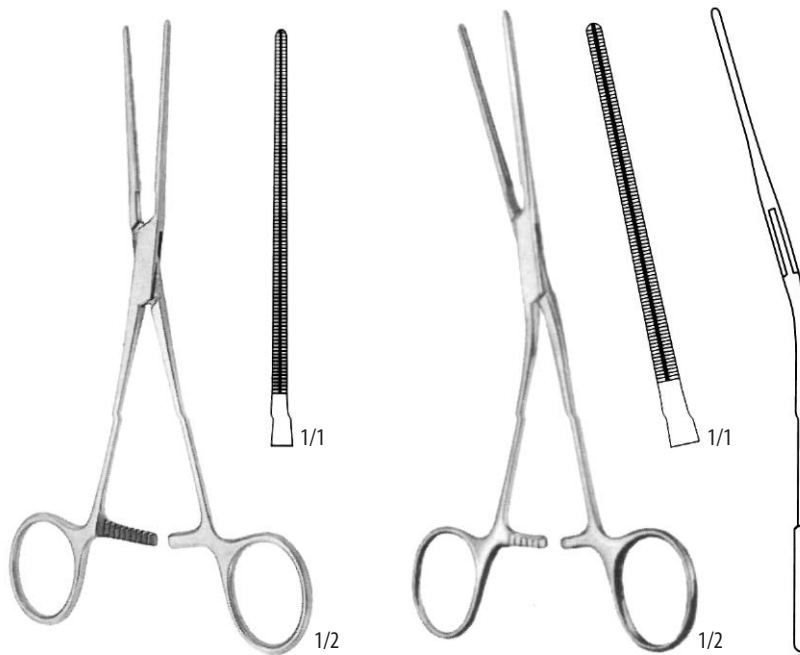

COOLEY
115 91 0732
17,0 cm

COOLEY
115 91 0733
17,0 cm



COOLEY

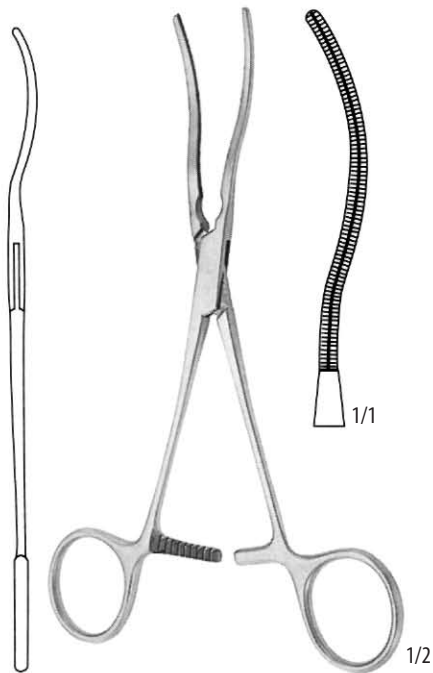

COOLEY
115 91 0734
 17,0 cm

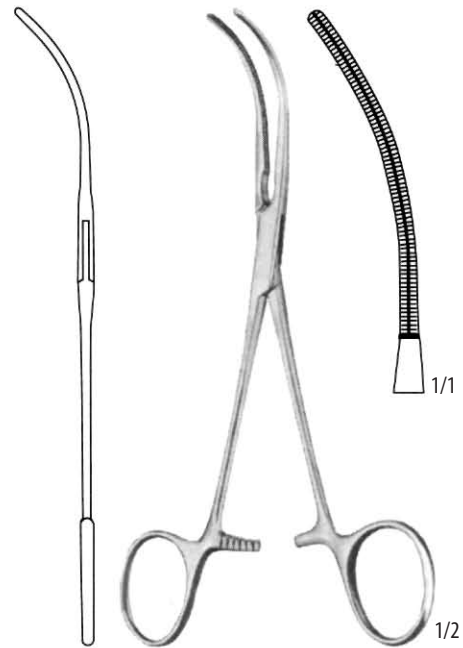

COOLEY
115 91 0735
 17,0 cm

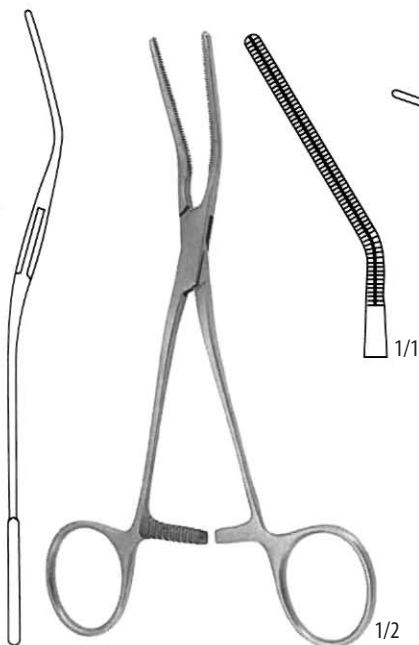

COOLEY
115 91 0736
 17,0 cm

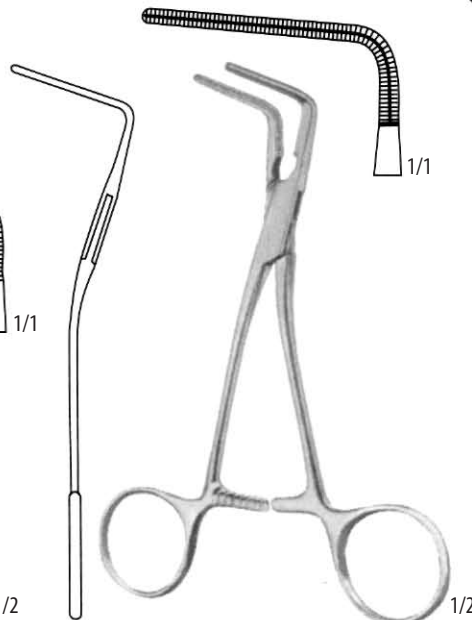

COOLEY
115 91 0737
 15,0 cm

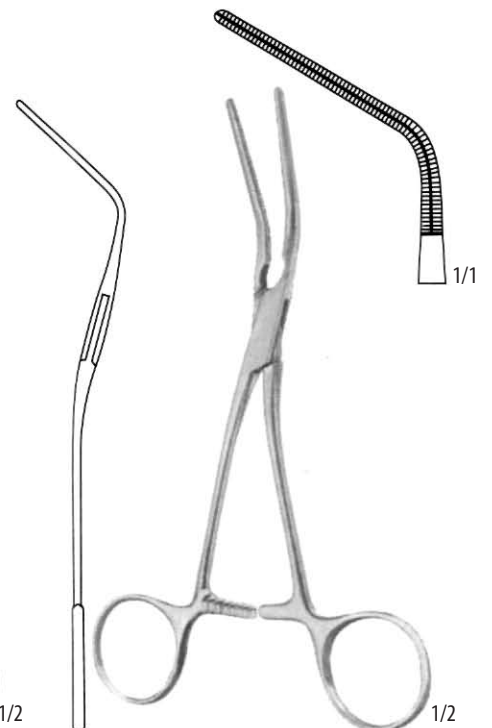

COOLEY
115 91 0738
 15,5 cm

SVORKY ATRAUMATICKÉ NA CÉVY
 ARTERY FORCEPS ATRAUMATIC JAWS

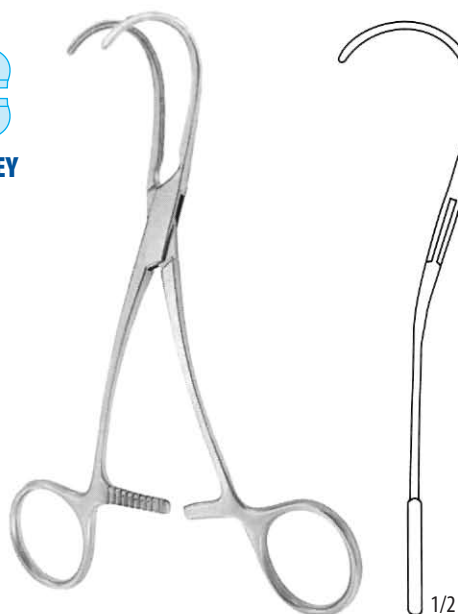

COOLEY



COOLEY

115 91 0739

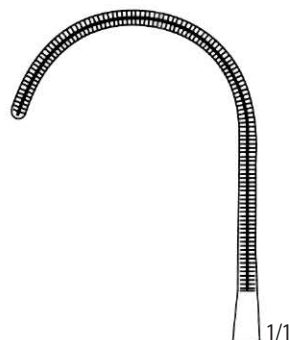
16,0 cm



1/1

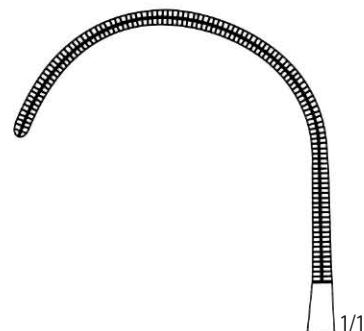

1/1

115 91 0740

17,0 cm

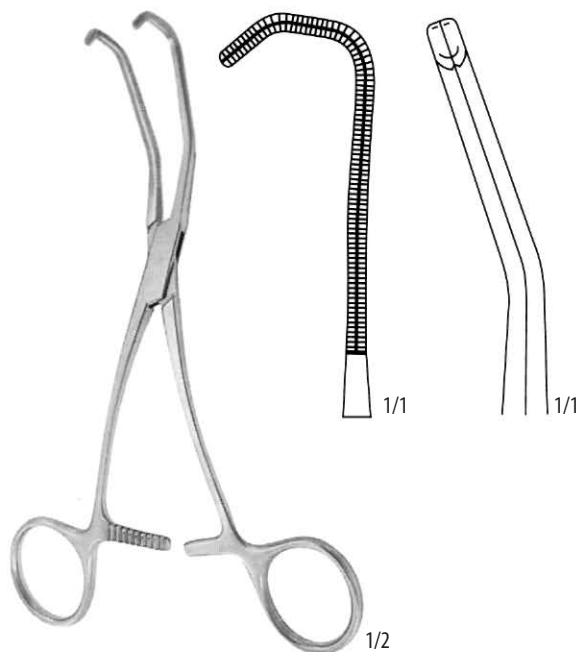
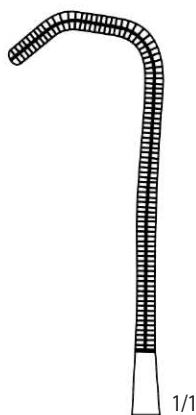
 COOLEY
 115 91 0741
 17,0 cm

1/1

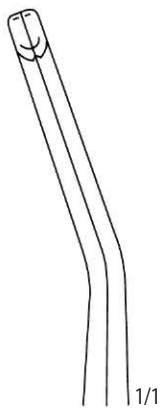

1/1

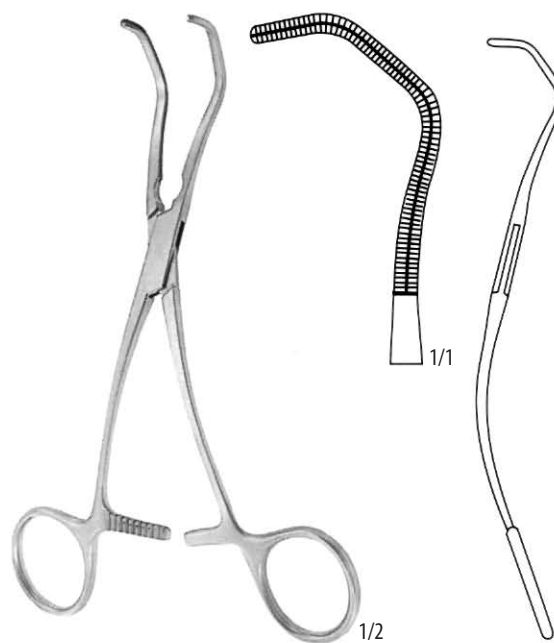
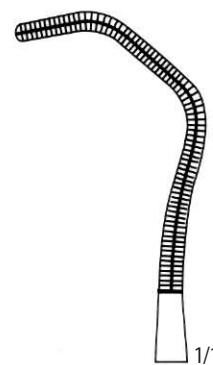
 COOLEY
 115 91 0742
 16,0 cm

1/1



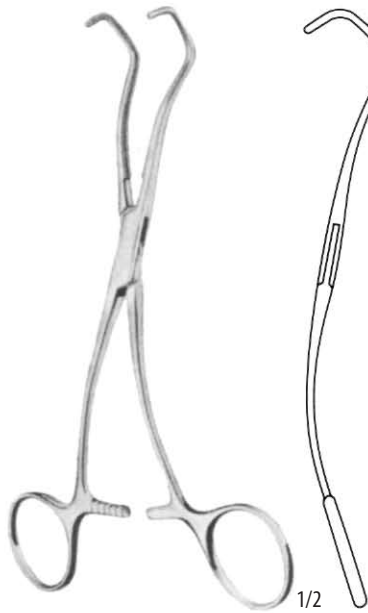
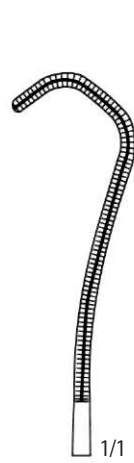

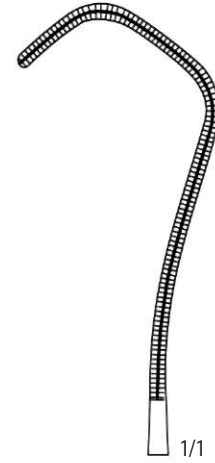
COOLEY-DERRA

115 91 0743
16,0 cm

115 91 0744
17,0 cm

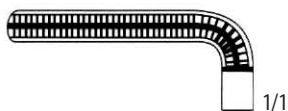
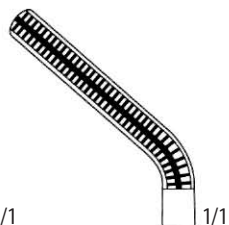
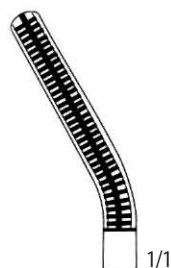
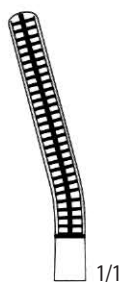
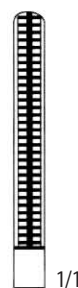
115 91 0745
18,0 cm

COOLEY

BECK
115 91 0746
17,0 cm

SVORKY ATRAUMICKÉ NA CÉVY
ARTERY FORCEPS ATRAUMATIC JAWS
**DARDIK**
115 91 0747
 13,0 cm

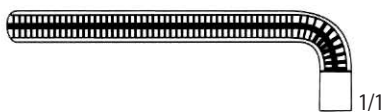
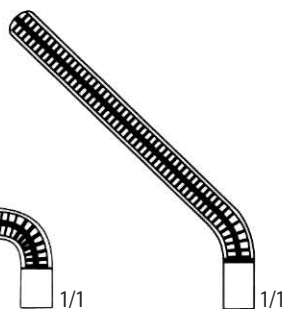
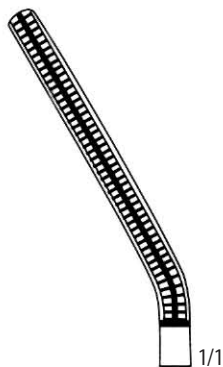
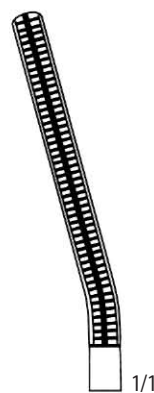
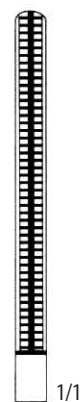
115 91 0748
 14,5 cm

115 91 0749
 15,0 cm

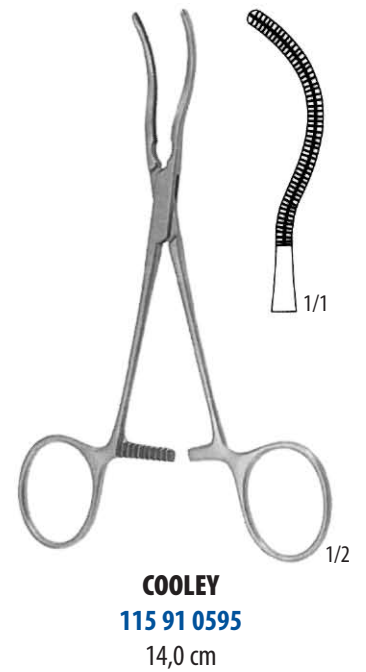
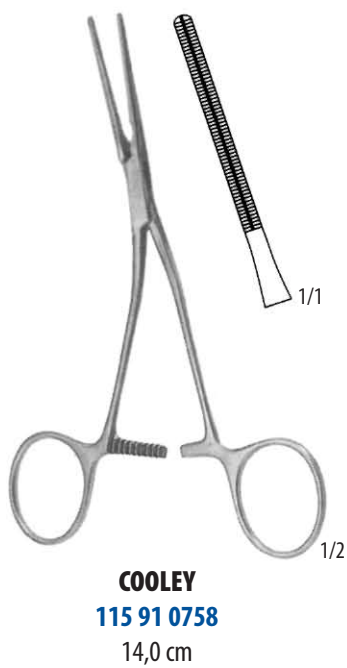
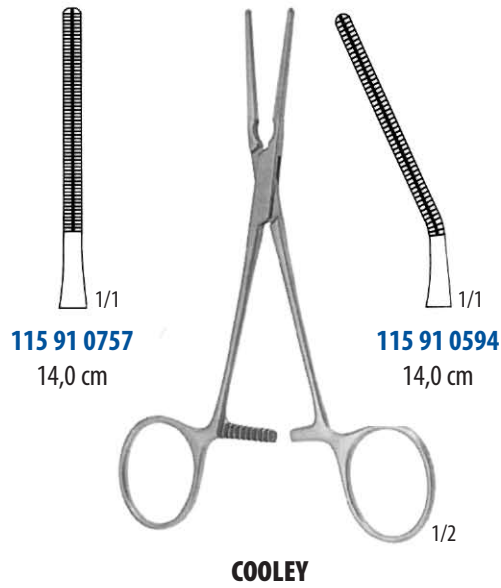
115 91 0750
 15,0 cm

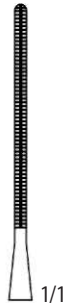
115 91 0751
 15,0 cm
**DARDIK**

1/2

115 91 0752
 13,5 cm

115 91 0753
 16,0 cm

115 91 0754
 17,0 cm

115 91 0755
 17,0 cm

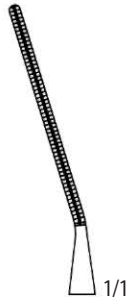
115 91 0756
 17,0 cm



COOLEY

SVORKY ATRAUMATICKÉ NA CÉVY
ARTERY FORCEPS ATRAUMATIC JAWS

1/1

115 91 0760
 14,0 cm

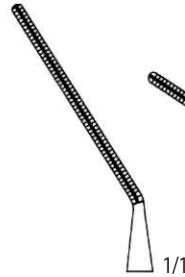
1/1

115 91 0761
 14,0 cm

1/1

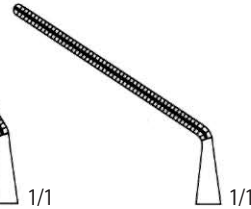
115 91 0762
 14,0 cm

1/1

115 91 0763
 13,0 cm

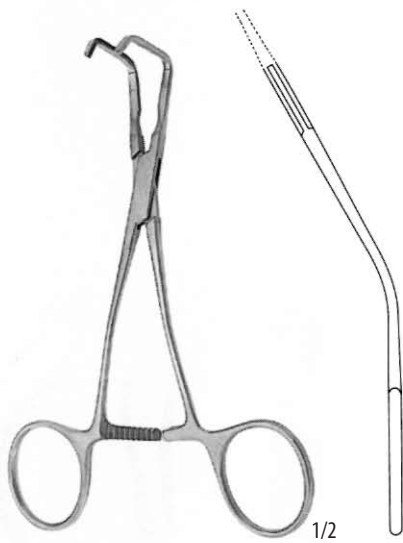

1/1

115 91 0764
 14,0 cm

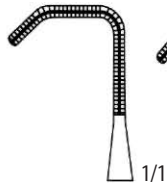
1/2

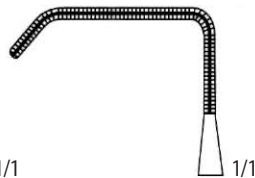

1/1

115 91 0765
 13,0 cm

1/1

115 91 0766
 13,0 cm

1/1

115 91 0767
 14,0 cm

1/1

115 91 0768
 13,5 cm

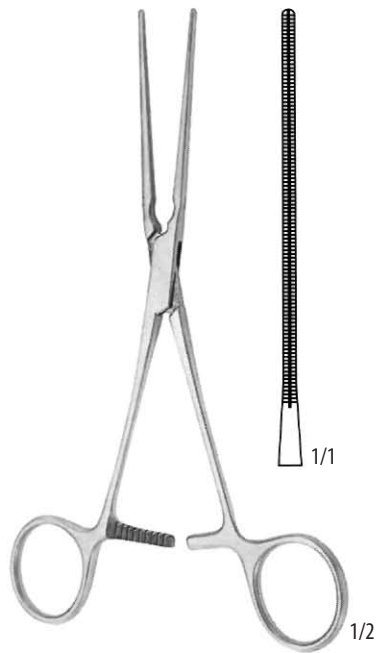

115 91 0769
16,5 cm

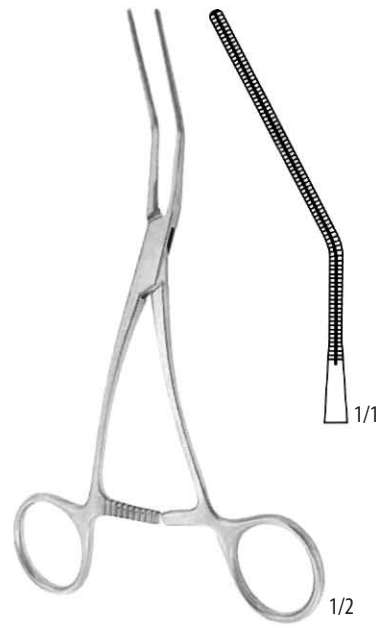

115 91 0770
16,0 cm

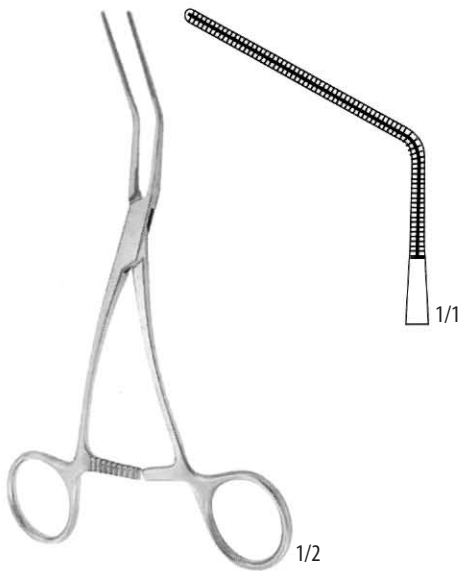

115 91 0771
15,0 cm

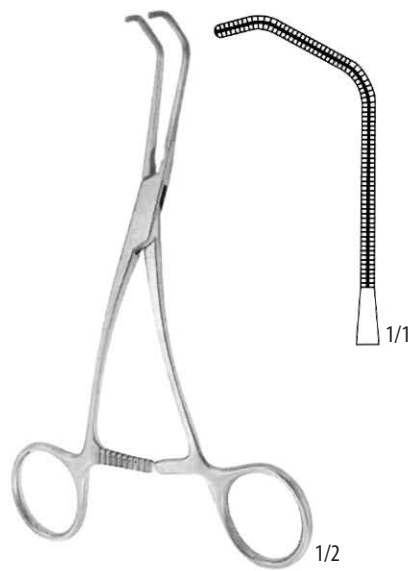

115 91 0772
15,0 cm

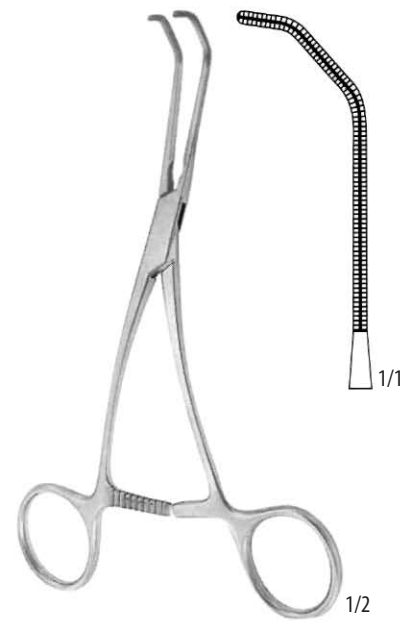

115 91 0773
15,5 cm

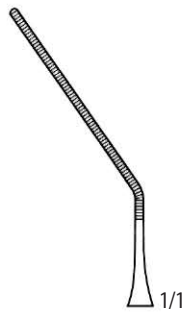

115 91 0774
13,0 cm

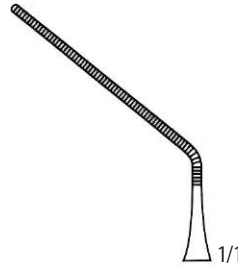

115 91 0775
13,0 cm



115 91 0776
11,0 cm

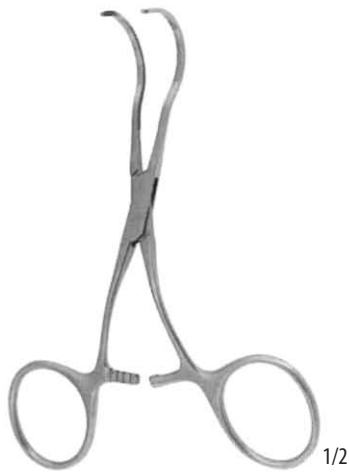

CASTANEDA

1/2

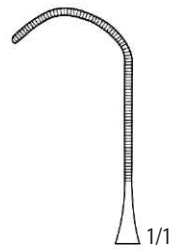

115 91 0777
12,0 cm

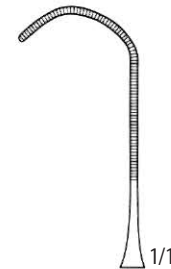

115 91 0778
12,0 cm

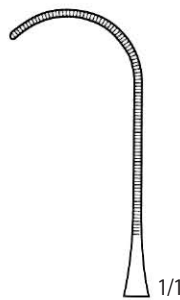

115 91 0779
12,0 cm

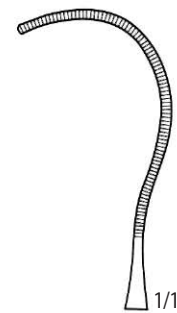

115 91 0780
12,0 cm

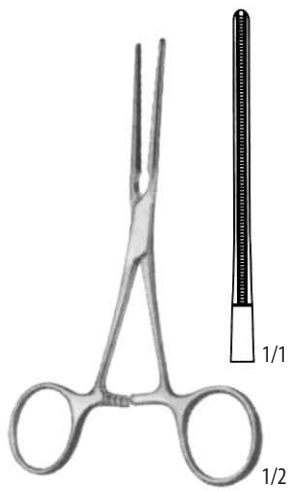

DE BAKEY
115 91 0781
12,0 cm

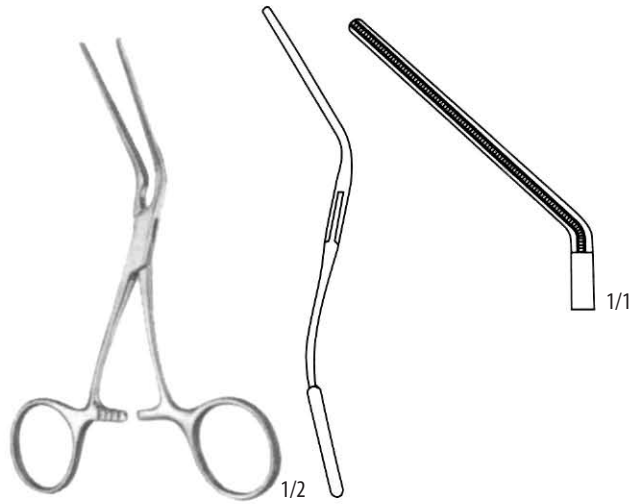

DE BAKEY
115 91 0782
13,0 cm

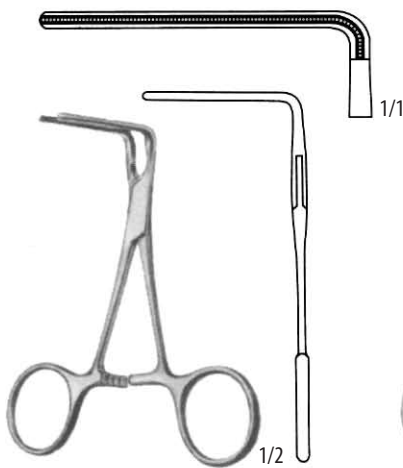

DE BAKEY
115 91 0783
10,0 cm

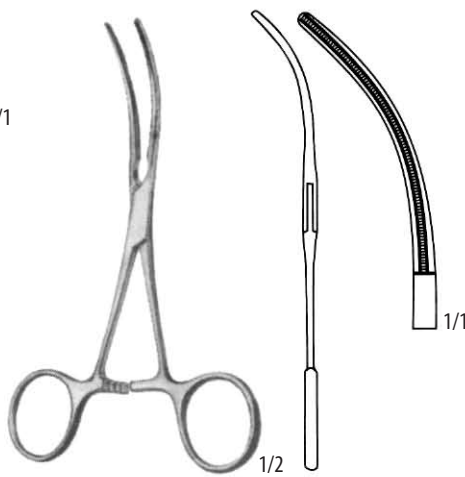

DE BAKEY
115 91 0784
11,0 cm

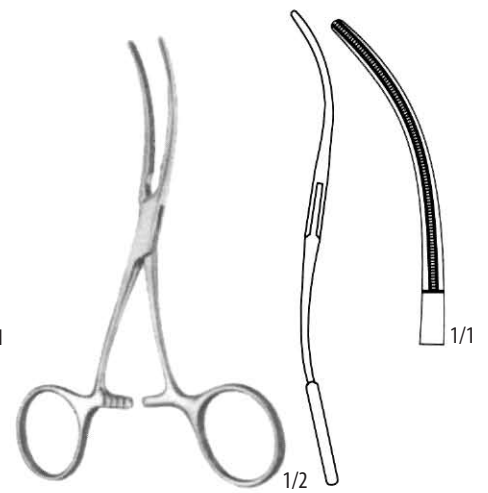

DE BAKEY
115 91 0785
12,0 cm

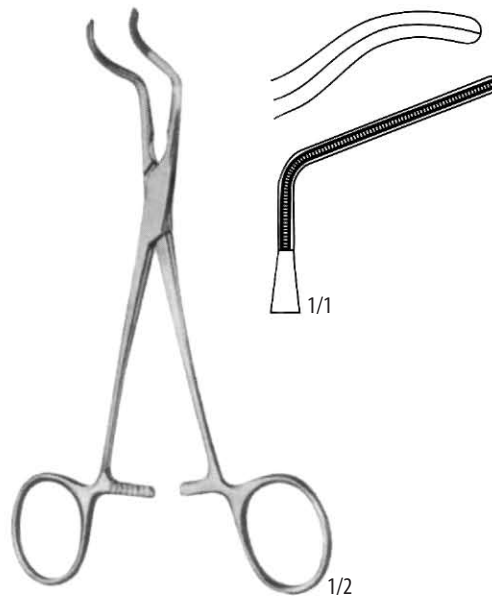

DE BAKEY

**SUBRAMANIAN-MINIATURE**

115 91 0786

15,5 cm

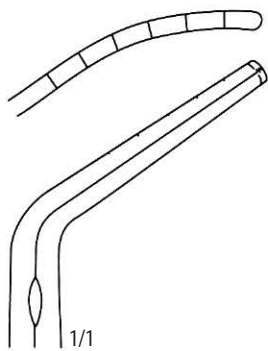
**SUBRAMANIAN**

115 91 0787

16,0 cm

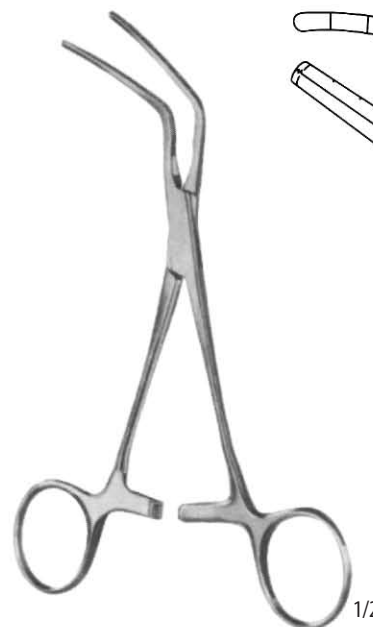
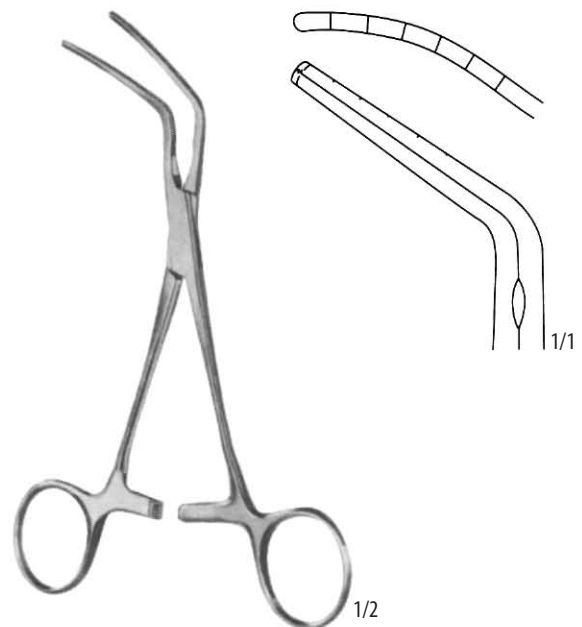
**SUBRAMANIAN**

115 91 0788

16,0 cm



SATINSKY
26,0 cm

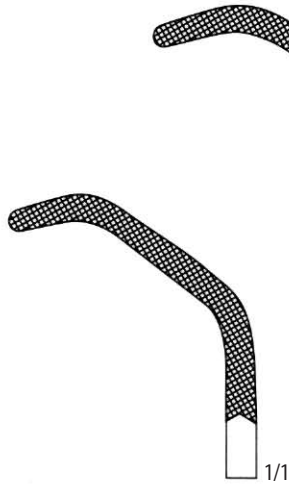

115 91 0796

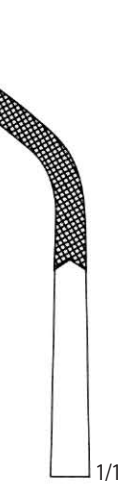

115 91 0797



BABY-SATINSKY
115 91 0798
15,0 cm

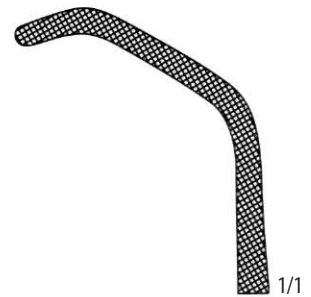

1/1

1/2



HARKEN
24,0 cm



115 91 0799
24,0 cm



115 91 0800
24,0 cm

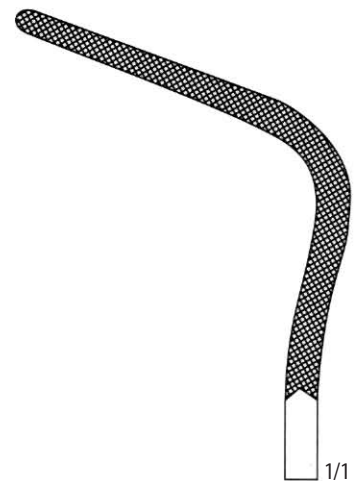

115 91 0801
24,0 cm

1/1

1/1

1/1

1/2



SCHAEDEL
115 91 0332
9,0 cm



JONES
115 91 0333 – 5,0 cm
115 91 0334 – 9,0 cm



ENGL. MODELL
115 91 0335
9,0 cm



DOYEN
115 91 0336
18,0 cm



BERNHARD
115 91 0337
16,5 cm



LANE
115 91 0338 – 15,0 cm
115 91 0339 – 18,0 cm
115 91 0340 – 20,0 cm



BACKHAUS
115 08 0780
11,8 cm



BACKHAUS
115 08 0790
12,0 cm

BACKHAUS-CLIP
115 91 0341

11,0 cm



Original 15,0 cm

BACKHAUS
115 91 0343 – 11,0 cm

115 91 0345 – 15,0 cm

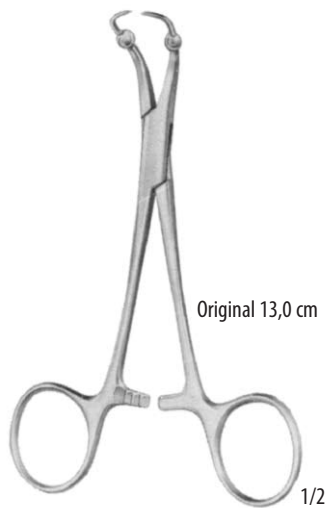

Original 13,0 cm

BACKHAUS
115 08 0810 – 8,0 cm

115 08 0820 – 13,0 cm

Original 13,0 cm

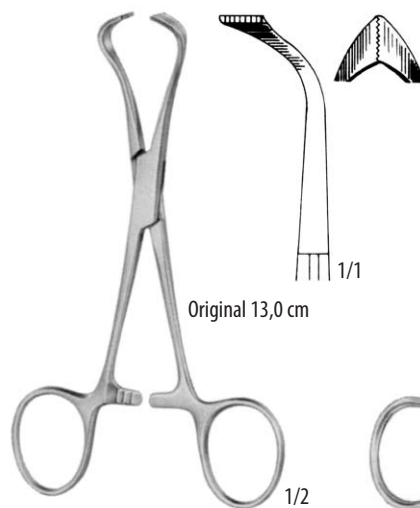
ROEDER
115 91 0348 – 13,0 cm

115 91 0349 – 15,0 cm

Original 13,0 cm

LORNA
115 91 0350 – 10,0 cm

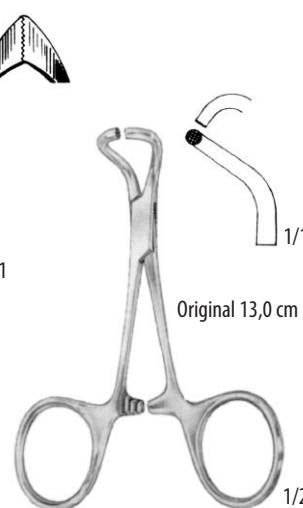
115 91 0351 – 13,0 cm

Original 13,0 cm

TOHOKU-JAPAN
115 91 0352 – 10,0 cm

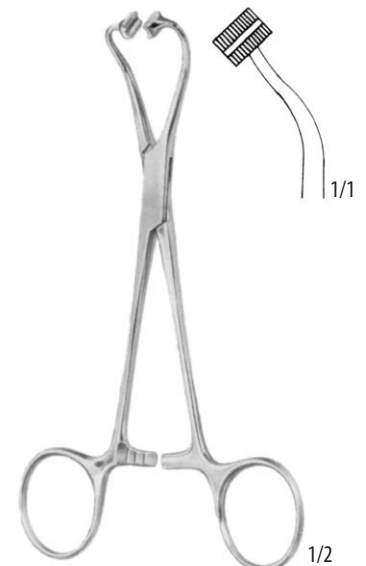
115 91 0353 – 13,0 cm

PEERS
115 91 0354

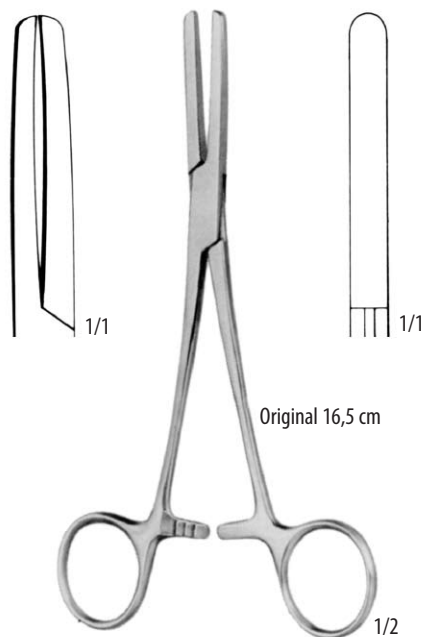
14,5 cm

SVORKY NA TRUBICE
TUBING CLAMPS

PRESBYTERIAN
115 91 0355 – 16,5 cm
115 91 0356 – 18,0 cm



KLINIKUM BERLIN
115 91 0357
14,5 cm

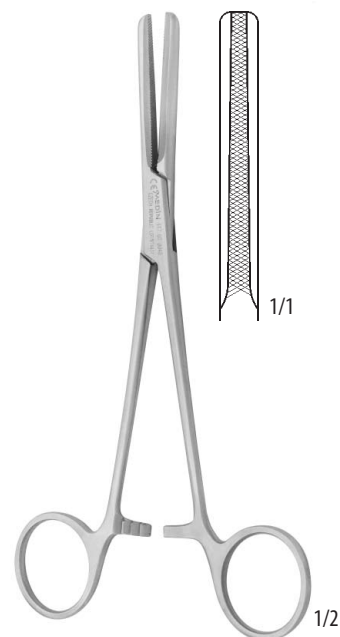

117 07 0040
16,0 cm

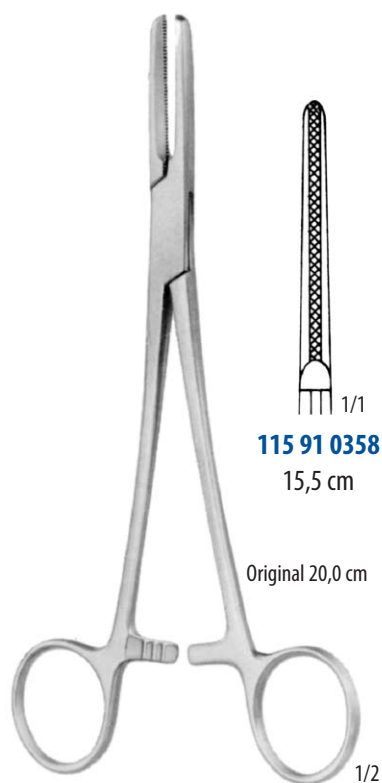

115 91 0358
15,5 cm

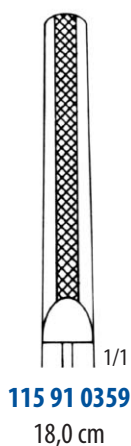

115 91 0359
18,0 cm

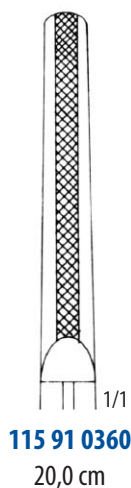

115 91 0360
20,0 cm

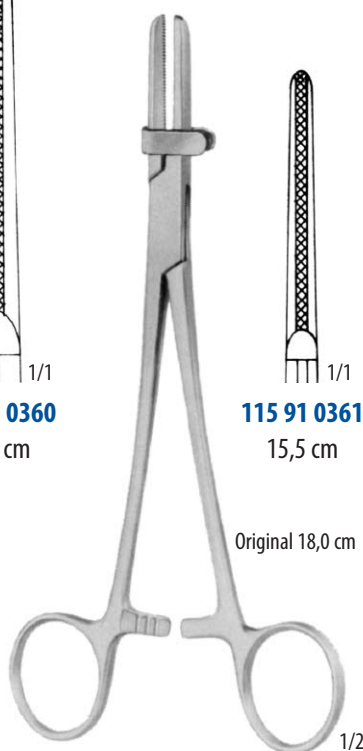

115 91 0361
15,5 cm

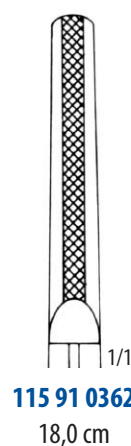

115 91 0362
18,0 cm

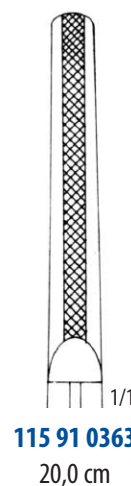

115 91 0363
20,0 cm



115 08 1000
32,5 cm





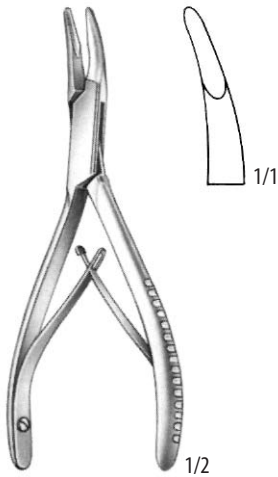

MINI-FRIEDMAN
116 91 0017
12,0 cm



FRIEDMAN
116 91 0514
14,0 cm

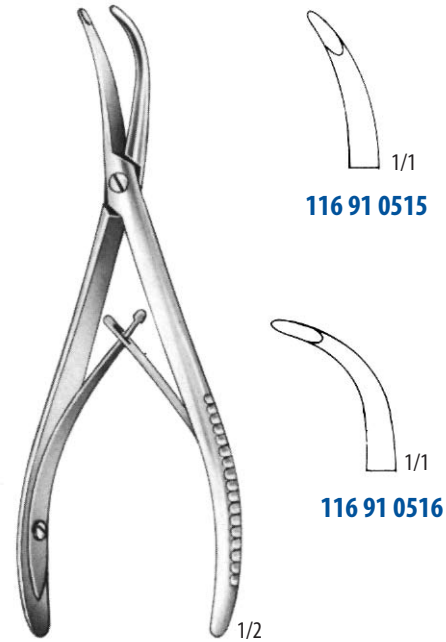

STELLBRINK
17,0 cm



116 91 0516

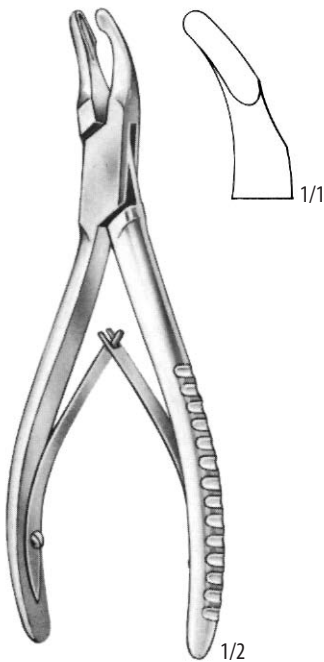

CLEVELAND
116 91 0518
17,0 cm

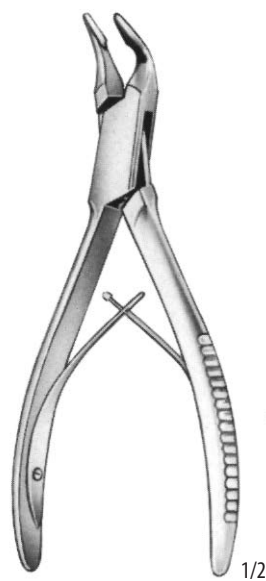

BLUMENTHAL
15,5 cm

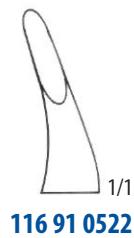

116 91 0522

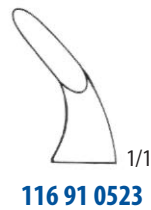

116 91 0523



116 91 0524

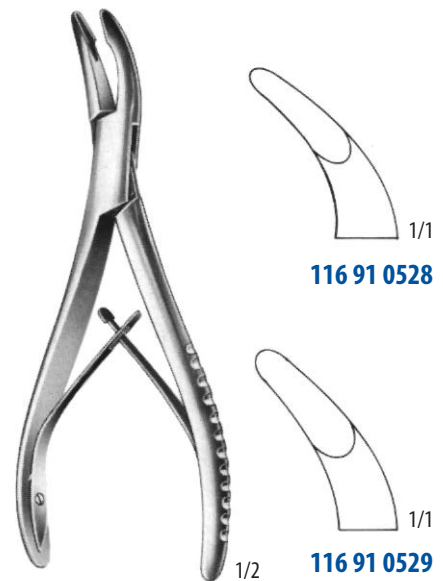

LUER
15,0 cm

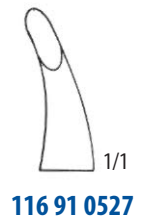

116 91 0527



116 91 0528

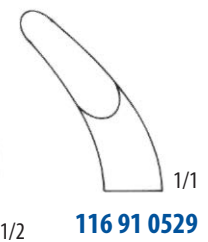

116 91 0529



LUER
rovné – straight
116 08 0030
17,0 cm

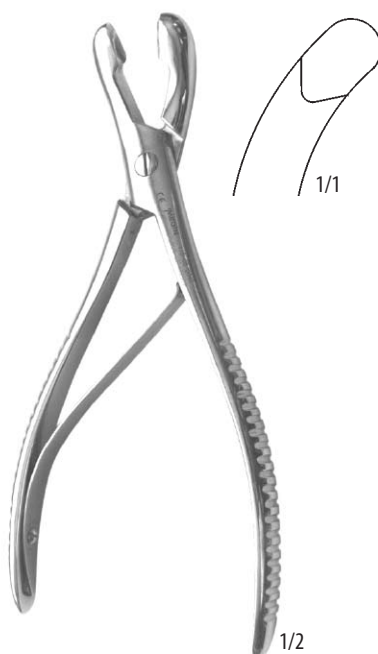

LUER
zahnuté – curved
116 08 0040
17,0 cm

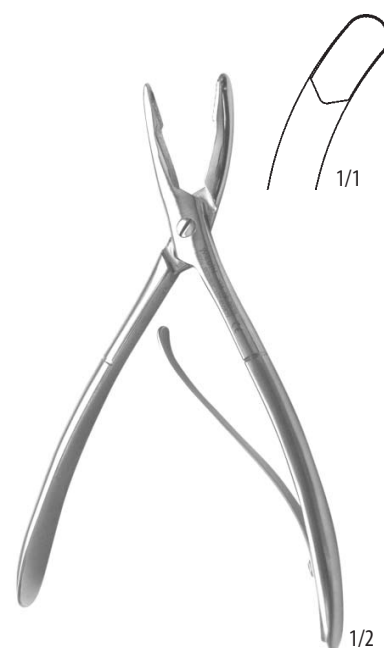

LUER
zahnuté – curved
116 08 0070
15,0 cm

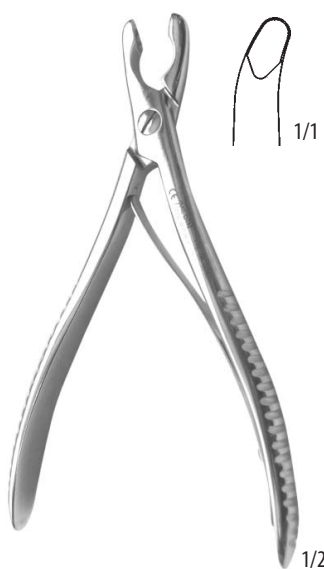

LUER
zahnuté – curved
116 08 0080
14,5 cm

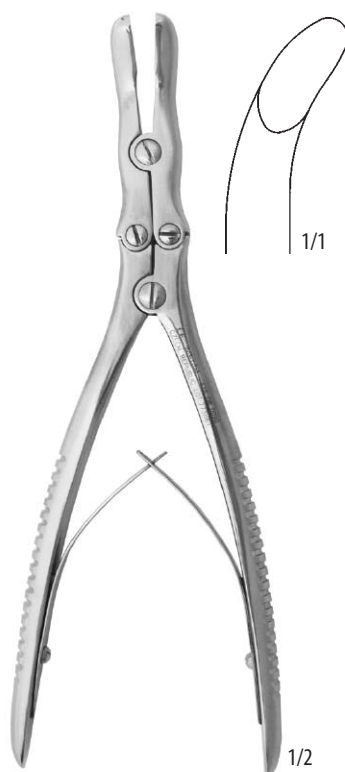

RUSKIN
zahnuté – curved
116 08 0090
20,0 cm

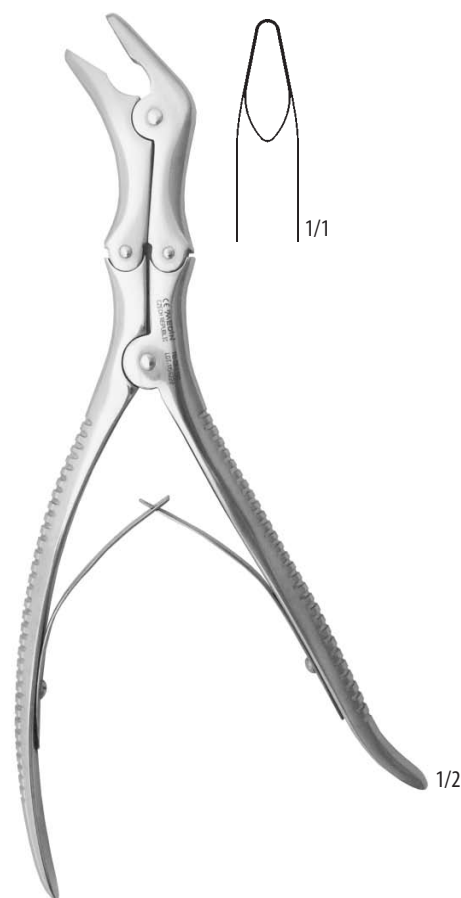

LUER
lomené – angled
116 08 0130
23,5 cm

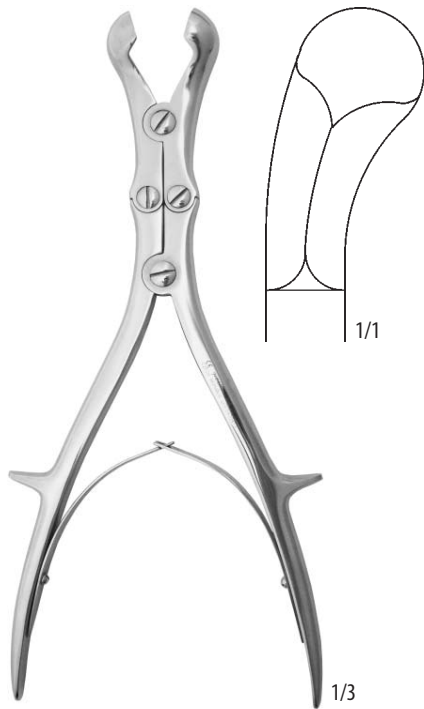

LUER
zahnuté – curved
116 08 0140
27,5 cm

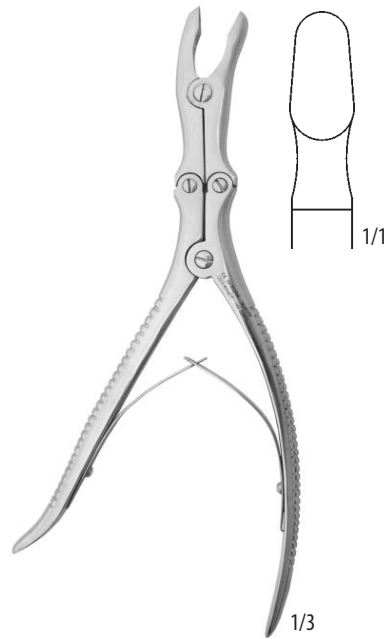

LUER
mírně lomené – light angled
116 08 0150
24,5 cm

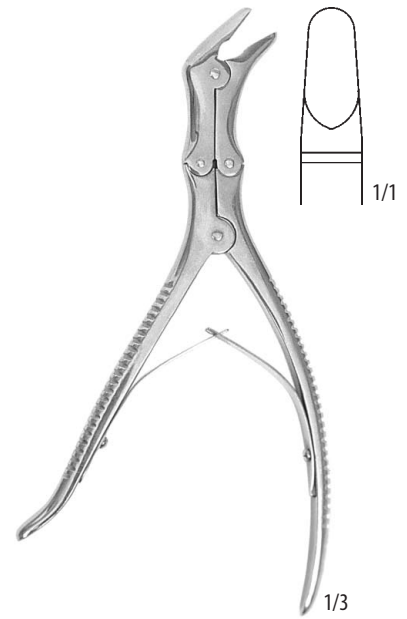

LUER
lomené – angled
116 08 0160
23,5 cm

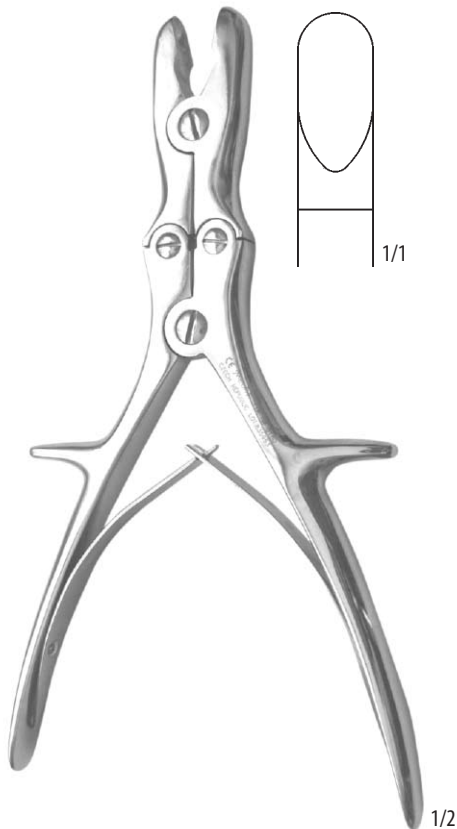

LUER
rovné – straight
116 08 0180
21,5 cm

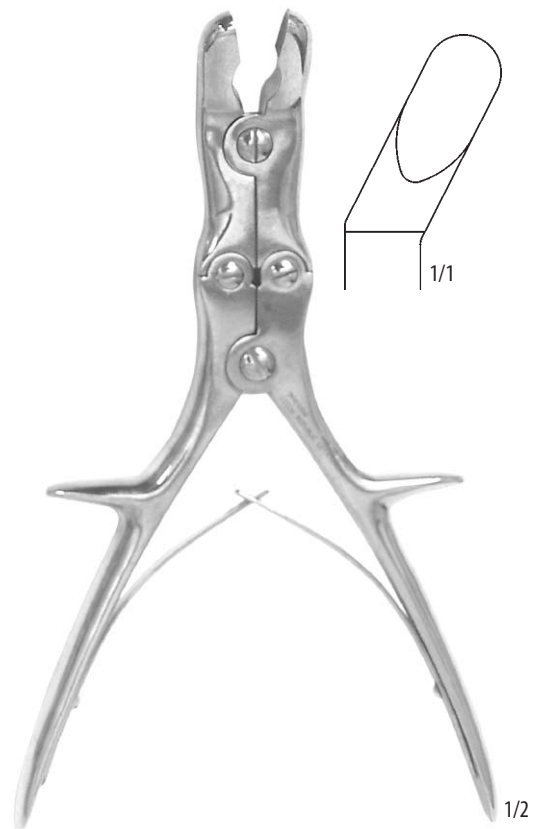

LUER-STILLE
zahnuté – curved
116 08 0190
21,5 cm



MARQUARDT
116 91 0258
20,0 cm



MAYFIELD
116 91 0259
17,0 cm

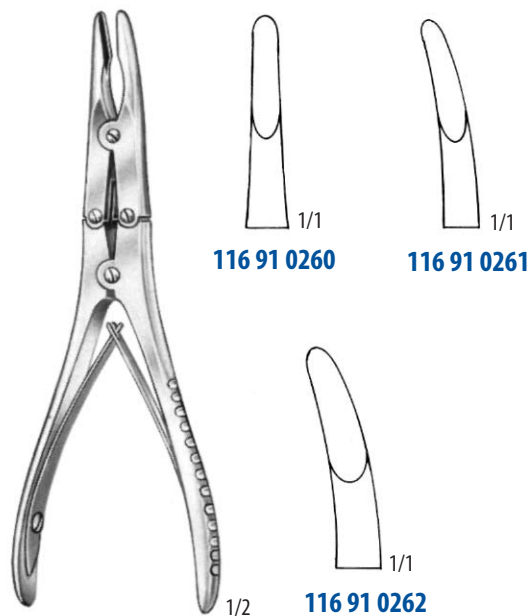

BÖHLER
15,0 cm

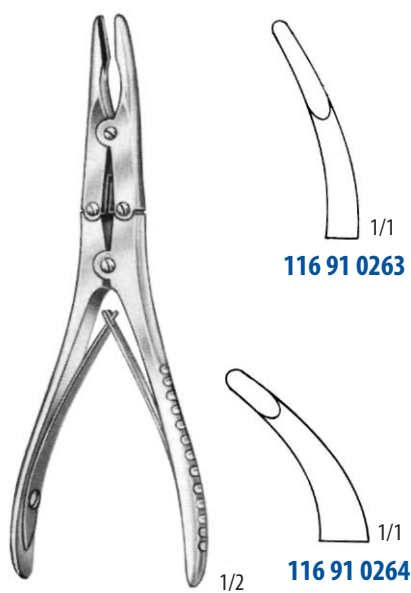

KEINERT-KUTZ
15,0 cm



BEYER
116 91 0266
18,0 cm

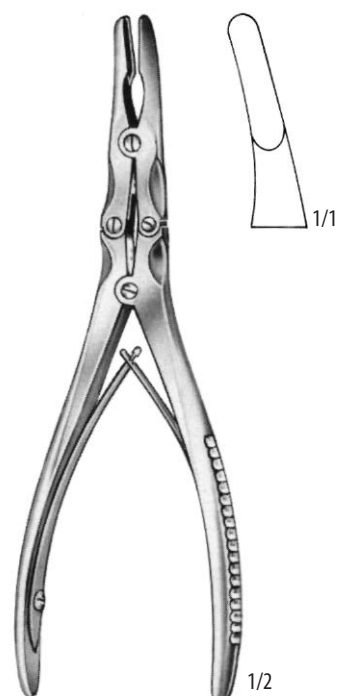

ZAUFAL-JANSEN
116 91 0267
18,0 cm

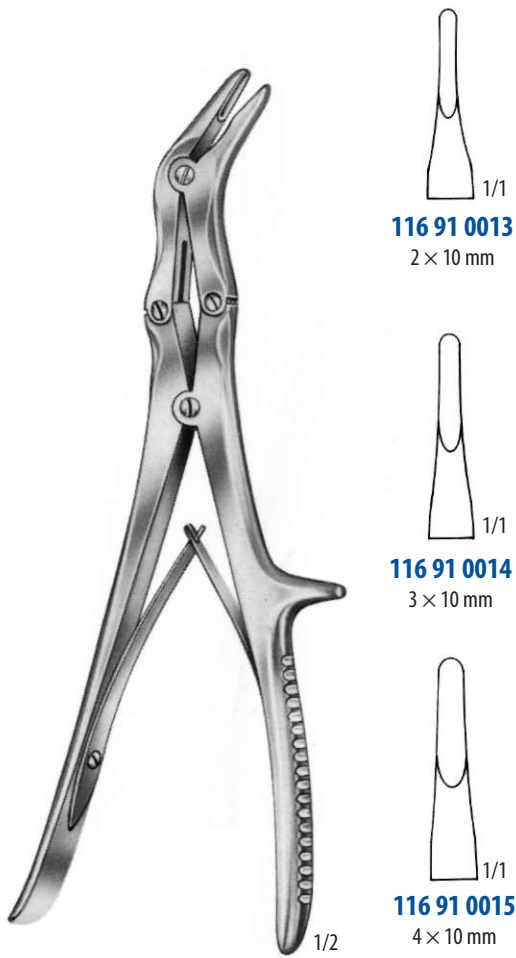

ECHLIN
23,0 cm

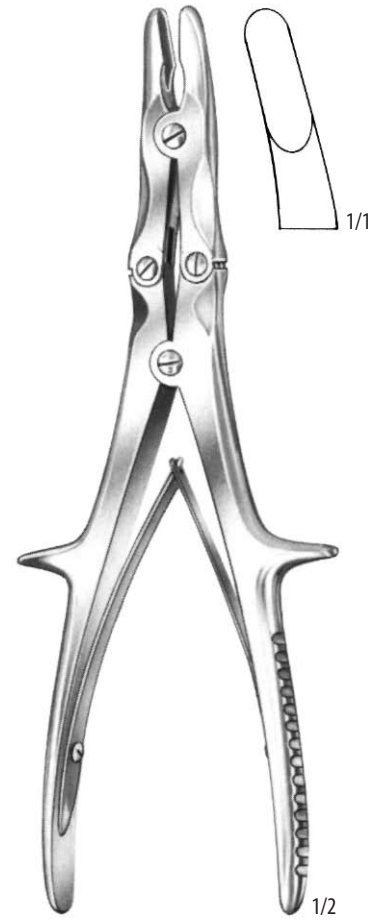

STILLE-RUSKIN
116 91 0271
23,0 cm



RUSKIN
116 91 0280
23,0 cm



SMITH-PETERSON
24,0 cm

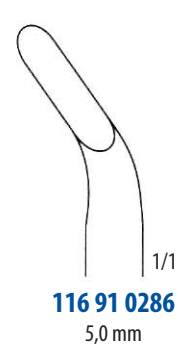
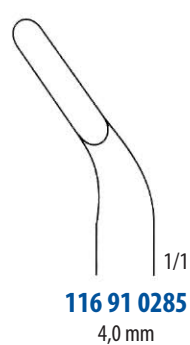
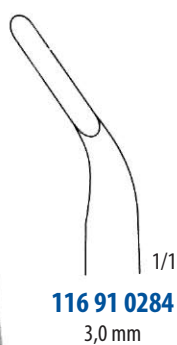
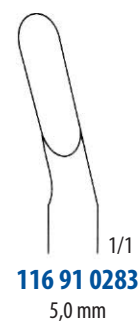
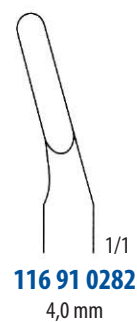
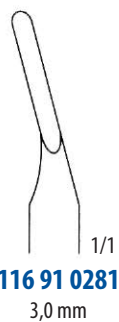

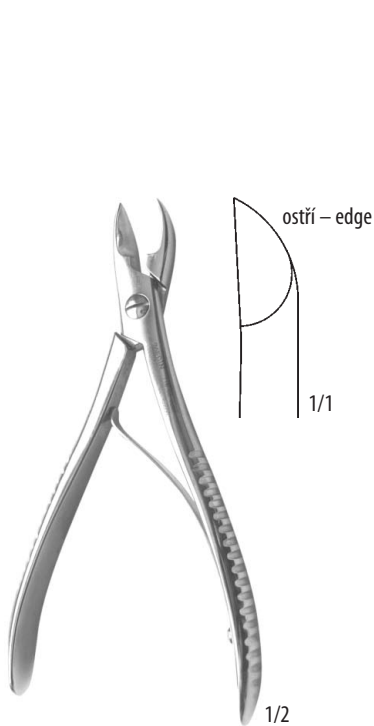

rovné – straight
116 08 0280
14,0 cm

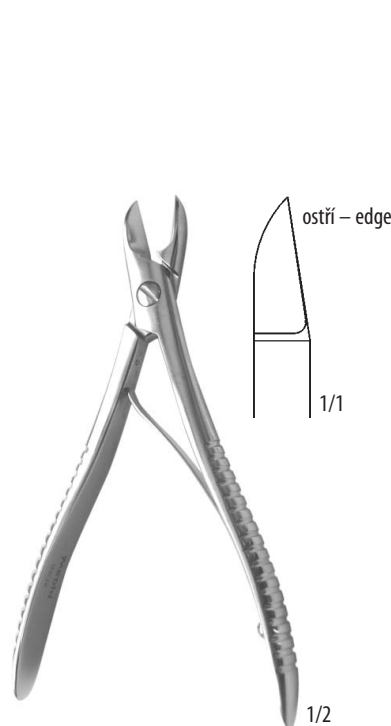

LISTON
rovné – straight
116 08 0410
14,0 cm

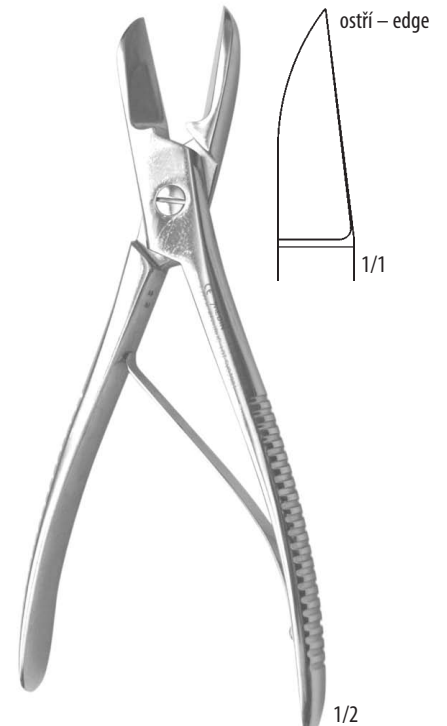

LISTON
rovné – straight
116 08 0440
19,0 cm

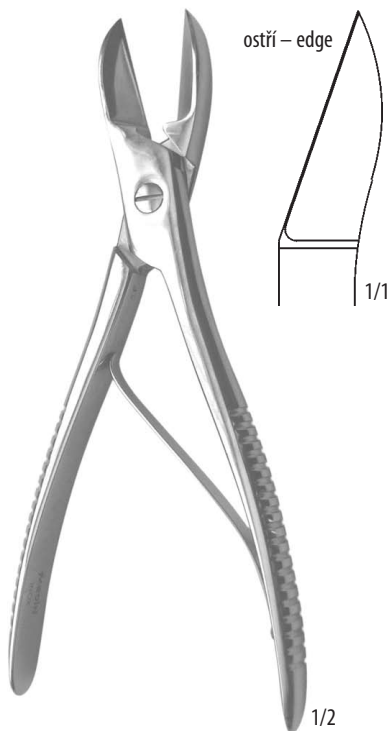

LISTON
zahnuté – curved
116 08 0450
19,0 cm



Original 17 cm
116 91 0291
17,0 cm

116 91 0294
14,0 cm

116 91 0295
17,0 cm

116 91 0293
22,0 cm

116 91 0297
22,0 cm

LISTON
17,0 cm

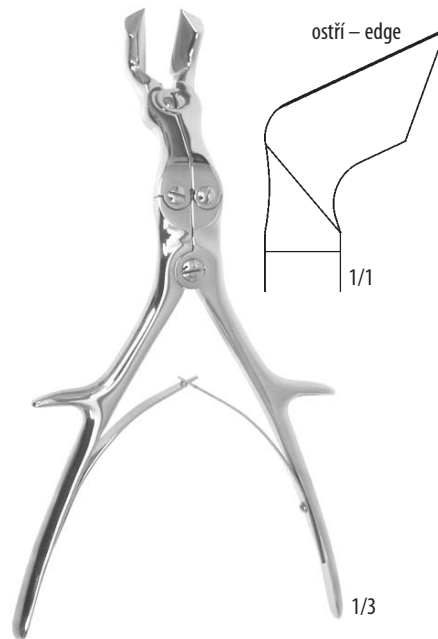
**LISTON**

dvojitě zahnuté – double curved

116 08 0470

24,6 cm

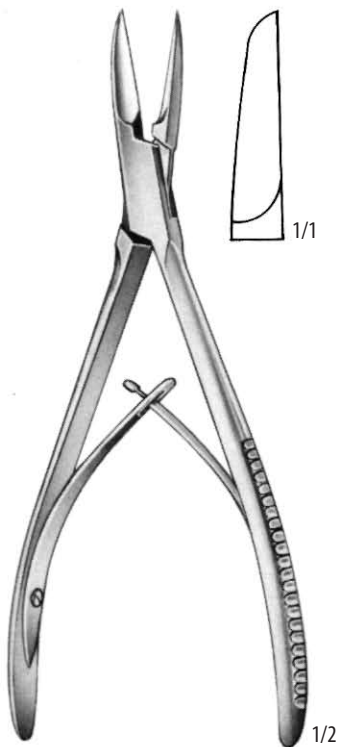
**COTTLE KAZANJIAN****116 91 0287**

19,0 cm

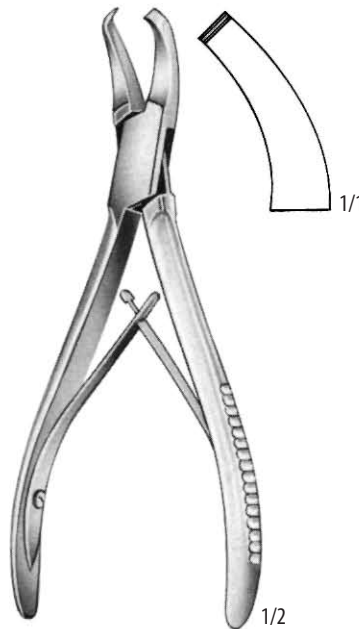
**CLEVELAND-GARDNER****116 91 0288**

16,0 cm

**MARKWALDER****116 91 0289**

20,0 cm



LITTAUER-LISTON
116 91 0298
15,0 cm

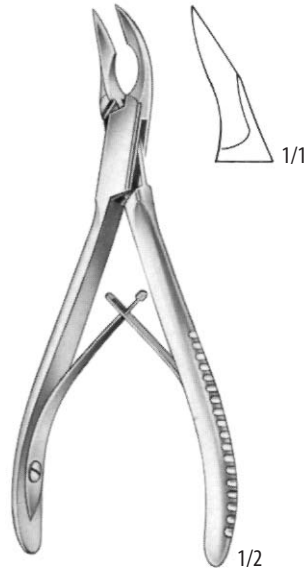

CLEVELAND
116 91 0299
15,0 cm

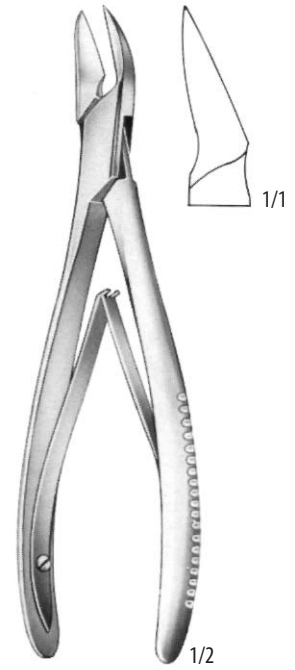

CLEVELAND
116 91 0300
17,0 cm



116 91 0301
12,0 cm

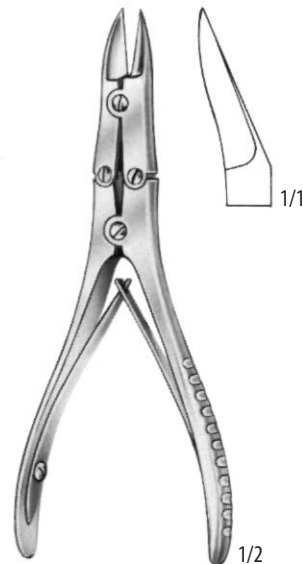

WALTON-LISTON
116 91 0305
15,0 cm



1/3

116 91 0548

22,0 cm



1/3

GLUCK**116 91 0140**

22,0 cm



1/3

BETHUNE**116 91 0549**

34,0 cm



1/3

SAUERBRUCH**116 91 0550**

26,0 cm



1/3

CORYLLOS**116 91 0551**

35,0 cm



1/3

CORYLLOS**116 91 0552**

35,0 cm



GIERTZ-STILLE
116 91 0256
27,0 cm



SAUERBRUCH-FREY
116 91 0553
36,0 cm



BRUNNER
32,0 cm



116 91 0555
32,0 cm



116 91 0556
32,0 cm



čistění nástroje
cleaning of the instrument

116 11 0700

délka ramene – length of the arm
12,0 cm

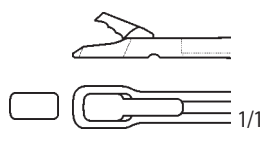

116 11 0670

přímé – straight
5,5 × 3,5 mm

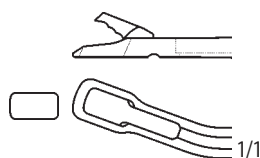

116 11 0680

vyhnuté vpravo 20° – right-bent 20°
5,5 × 3,5 mm

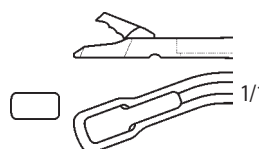

116 11 0690

vyhnuté vlevo 20° – left-bent 20°
5,5 × 3,5 mm

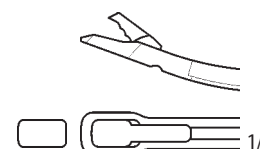

116 11 0675

zahnuté nahoru 20° – up curved 20°
5,5 × 3,5 mm

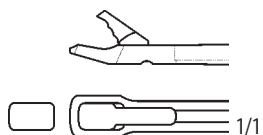

116 11 0620

čelist nahoru 16° – tip up 16°
4,5 × 3,5 mm

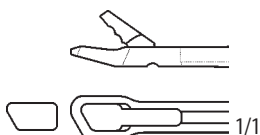

116 11 0630

šikmé levé – slant left
čelist nahoru 15° – tip up 15°
5 × 3,5 mm

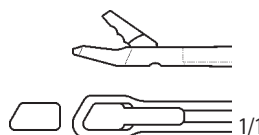

116 11 0640

šikmé pravé – slant right
čelist nahoru 15° – tip up 15°
5 × 3,5 mm

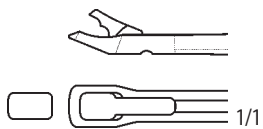

116 11 0570

čelist nahoru 22° – tip up 22°
5,5 × 3,5 mm

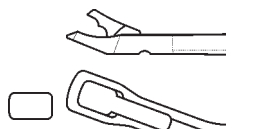

116 11 0580

vyhnuté vpravo 20° – right-bent 20°
čelist nahoru 22° – tip up 22°
5,5 × 3,5 mm

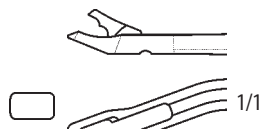

116 11 0590

vyhnuté vlevo 20° – left-bent 20°
čelist nahoru 22° – tip up 22°
5,5 × 3,5 mm

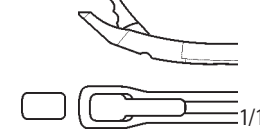

116 11 0575

zahnuté nahoru 20° – up curved 20°
čelist nahoru 22° – tip up 22°
5,5 × 3,5 mm

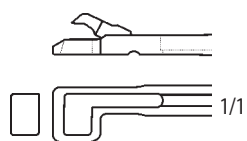

116 11 0810

čelist 90° vlevo – tip 90° left
7,5 × 5,5 mm

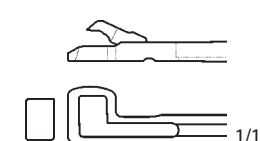

116 11 0820

čelist 90° vpravo – tip 90° right
5,5 × 7,5 mm



úzké – narrow
2,6 mm

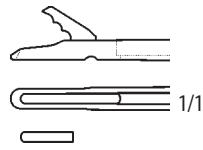

116 11 0750
přímé – straight
5 × 1,3 mm

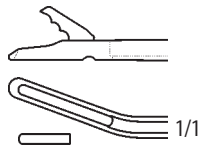

116 11 0760
vyhnuté vpravo 20° – right-bent 20°
5 × 1,3 mm

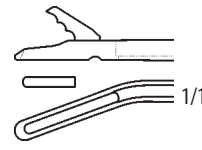

116 11 0770
vyhnuté vlevo 20° – left-bent 20°
5 × 1,3 mm

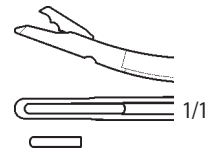

116 11 0755
zahnuté nahoru 20° – up curved 20°
5 × 1,3 mm



úzké – narrow
2,6 mm

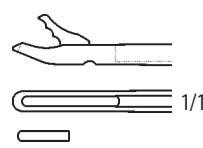

116 11 0780
čelist nahoru 22° – tip up 22°
5 × 1,3 mm

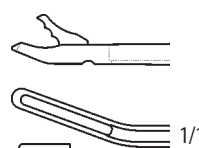

116 11 0790
vyhnuté vpravo 20° – right-bent 20°
čelist nahoru 22° – tip up 22°
5 × 1,3 mm

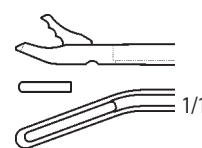

116 11 0800
vyhnuté vlevo 20° – left-bent 20°
čelist nahoru 22° – tip up 22°
5 × 1,3 mm

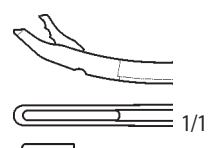

116 11 0785
zahnuté nahoru 20° – up curved 20°
čelist nahoru 22° – tip up 22°
5 × 1,3 mm

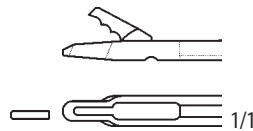

116 11 0600
přímé – straight
5,5 × 1 mm

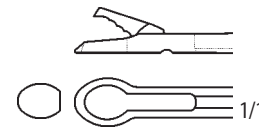

116 11 0700
oválné – oval
6,3 × 4,5 mm

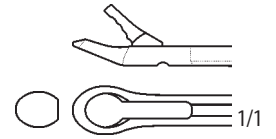

116 11 0710
oválné – oval
čelist nahoru 22° – tip up 22°
6,3 × 4,5 mm

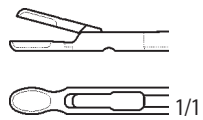

116 11 0830
miskové – bowl-shaped
3,5 × 2,7 mm

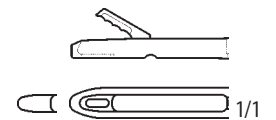

116 11 0650
miskové – bowl-shaped
4 × 2,2 mm

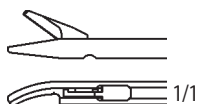

116 11 0950
nůžky – scissors
zahnuté vlevo – left curved

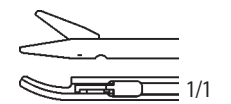

116 11 0960
nůžky – scissors
zahnuté vpravo – right curved

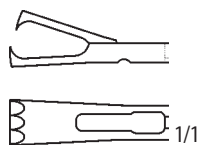
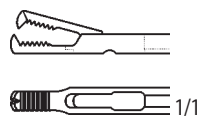
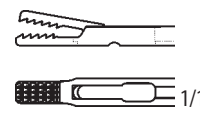
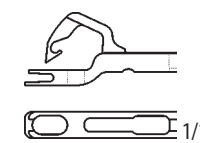
KLEŠTĚ ARTROSKOPICKÉ
ARTHROSCOPY FORCEPS**116 11 0660**úchopné – grasping
6 mm**116 11 0850**úchopné – grasping
2,5 mm**116 11 0840**úchopné – grasping
3 mm**116 11 0860**propichovací – piercing
3 mm**116 11 0870**propichovací – piercing
3 mm
30° nahoru – 30° up**116 11 0900**

šicí – suturing

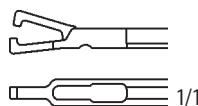
**116 11 1000**

extraktor stehů – suture extractor

otočné 360° – turning round 360°

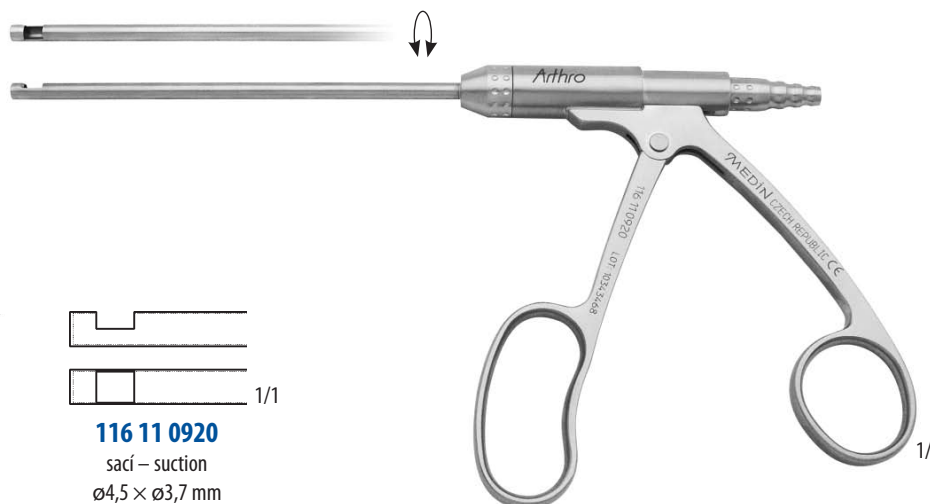
**116 11 0920**sací – suction
ø4,5 × ø3,7 mm**116 11 0920**délka ramene – length of the arm
12,0 cm

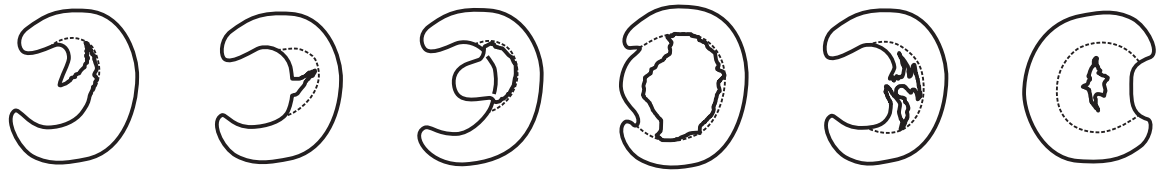

	papouščí zobák	radiální trhlina	lalúčkovitá trhlina	ucho od košíku	rozsáhlá trhlina	trhlina v diskoidním menisku
	parrot beak	transverse	flap	bucket handle	complex	discoid meniscus degeneration and tear
zadní posterior 	116 11 0600	116 11 0600	116 11 0600	116 11 0600	116 11 0600	116 11 0600
	116 11 0750	116 11 0750	116 11 0750	116 11 0750	116 11 0750	116 11 0750
	116 11 0755	116 11 0755	116 11 0755	116 11 0755	116 11 0755	116 11 0755
	116 11 0760	116 11 0760	116 11 0760	116 11 0760	116 11 0760	116 11 0760
	116 11 0770	116 11 0770	116 11 0770	116 11 0770	116 11 0770	116 11 0770
	116 11 0780	116 11 0780	116 11 0780	116 11 0780	116 11 0780	116 11 0780
	116 11 0785	116 11 0785	116 11 0785	116 11 0785	116 11 0785	116 11 0785
	116 11 0790	116 11 0790	116 11 0790	116 11 0790	116 11 0790	116 11 0790
	116 11 0800	116 11 0800	116 11 0800	116 11 0800	116 11 0800	116 11 0800
	116 11 0670	116 11 0670	116 11 0670	116 11 0670	116 11 0670	116 11 0670
	116 11 0675	116 11 0675	116 11 0675	116 11 0675	116 11 0675	116 11 0675
	116 11 0680	116 11 0680	116 11 0680	116 11 0680	116 11 0680	116 11 0680
	116 11 0690	116 11 0690	116 11 0690	116 11 0690	116 11 0690	116 11 0690
	116 11 0950	116 11 0950	116 11 0950	116 11 0950	116 11 0950	116 11 0950
116 11 0960	116 11 0960	116 11 0960	116 11 0960	116 11 0960	116 11 0960	
116 11 0700	116 11 0700	116 11 0700	116 11 0700	116 11 0700	116 11 0700	
116 11 0710	116 11 0710	116 11 0710	116 11 0710	116 11 0710	116 11 0710	
střední middle 	116 11 0670	116 11 0670	116 11 0670	116 11 0670	116 11 0670	116 11 0670
	116 11 0675	116 11 0675	116 11 0675	116 11 0675	116 11 0675	116 11 0675
	116 11 0680	116 11 0680	116 11 0680	116 11 0680	116 11 0680	116 11 0680
	116 11 0690	116 11 0690	116 11 0690	116 11 0690	116 11 0690	116 11 0690
	116 11 0700	116 11 0700	116 11 0700	116 11 0700	116 11 0700	116 11 0700
116 11 0710	116 11 0710	116 11 0710	116 11 0710	116 11 0710	116 11 0710	
přední anterior 	116 11 0700	116 11 0700	116 11 0700	116 11 0700	116 11 0700	116 11 0700
	116 11 0710	116 11 0710	116 11 0710	116 11 0710	116 11 0710	116 11 0710
	116 11 0810	116 11 0810	116 11 0810	116 11 0810	116 11 0810	116 11 0810
	116 11 0820	116 11 0820	116 11 0820	116 11 0820	116 11 0820	116 11 0820
	116 11 0950	116 11 0950	116 11 0950	116 11 0950	116 11 0950	116 11 0950
	116 11 0960	116 11 0960	116 11 0960	116 11 0960	116 11 0960	116 11 0960



přímé: základní tvar pro přímý přístup
 straight: basic shape for direct approach



čelist nahoru: sklon čelisti umožňuje rozšířený přístup k střednímu menisku
 tip up: the inclination of the tip enables enhanced access to posterior meniscus



zahnuté nahoru: zahnutí odpovídá obrysu kondylu a udržuje řeznou plochu paralelně k tibialnímu platu
 up curved: curvature follows the contour of the condyle and keeps the cutting surface parallel to the tibial plateau



vyhnuté vlevo a vpravo: umožňují přístup k přední a zadní části

left and right bent: enable the access to anterior and posterior meniscus

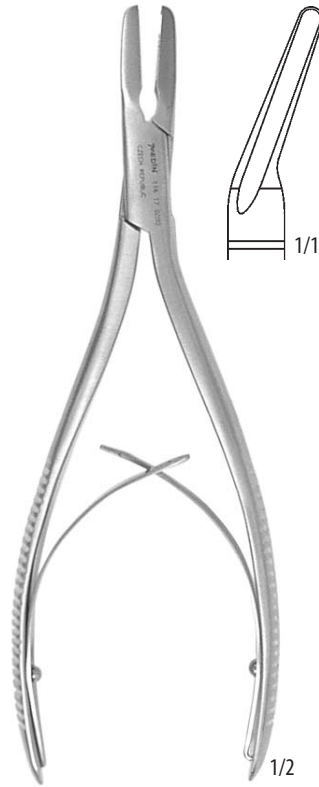

ZIELKE
116 17 0330
přímý – straight
20,4 cm

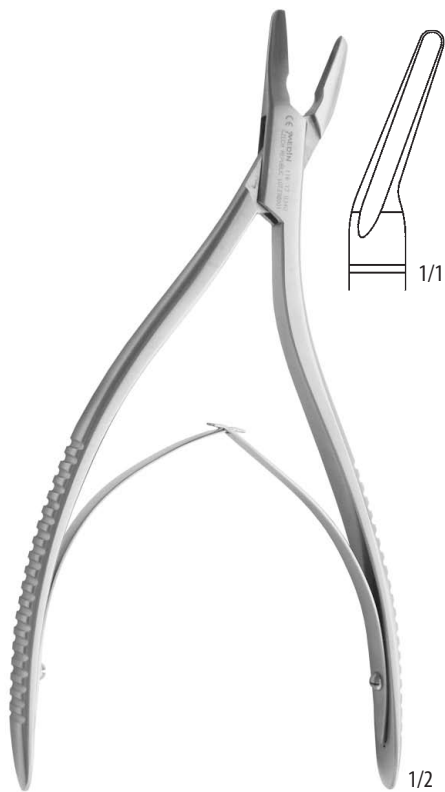

ZIELKE
116 17 0340
vyhnutý vpravo – eshewed right
20,6 cm

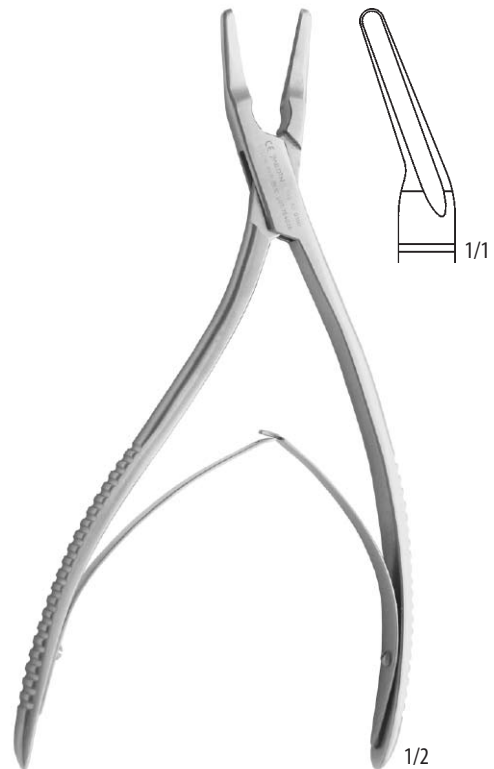

ZIELKE
116 17 0350
vyhnutý vlevo – eshewed left
20,0 cm

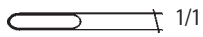

116 17 0360
12 × 2 mm

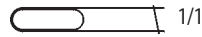

116 17 0380
12 × 3 mm

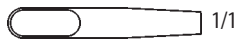
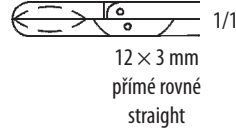

116 17 0390
12 × 4 mm



116 17 0400
12 × 5 mm



116 17 0410
12 × 6 mm

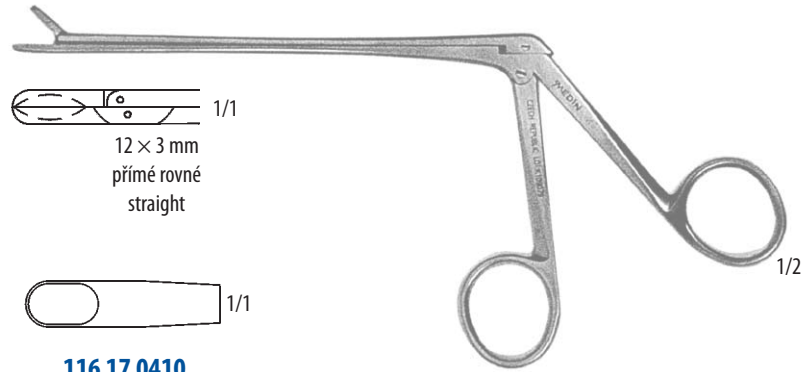

116 17 0380
délka ramene – length of arm
14,0 cm

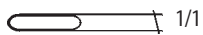

116 17 0440
12 × 2 mm

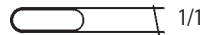

116 17 0460
12 × 3 mm

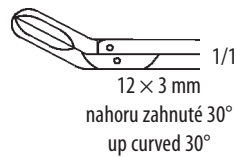

116 17 0470
12 × 4 mm



116 17 0480
12 × 5 mm



116 17 0490
12 × 6 mm

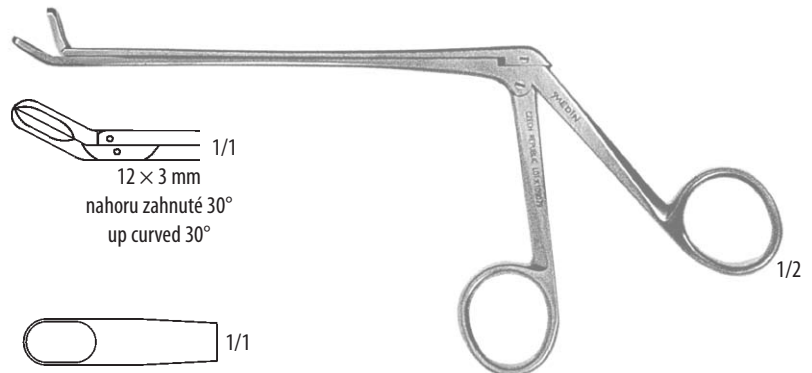

116 17 0460
délka ramene – length of arm
14,0 cm

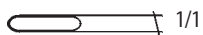

116 17 0520
12 × 2 mm

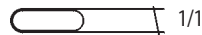

116 17 0540
12 × 3 mm

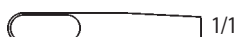
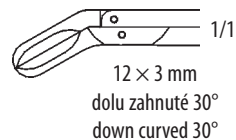

116 17 0550
12 × 4 mm



116 17 0560
12 × 5 mm

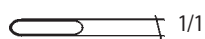
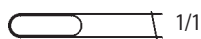
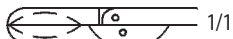

116 17 0570
12 × 6 mm

KLEŠTĚ NA MEZIOBRATLOVÉ PLOTÉNKY
LAMINECTOMY RONGEURS

116 17 0840
 12 × 2 mm

116 17 0860
 12 × 3 mm

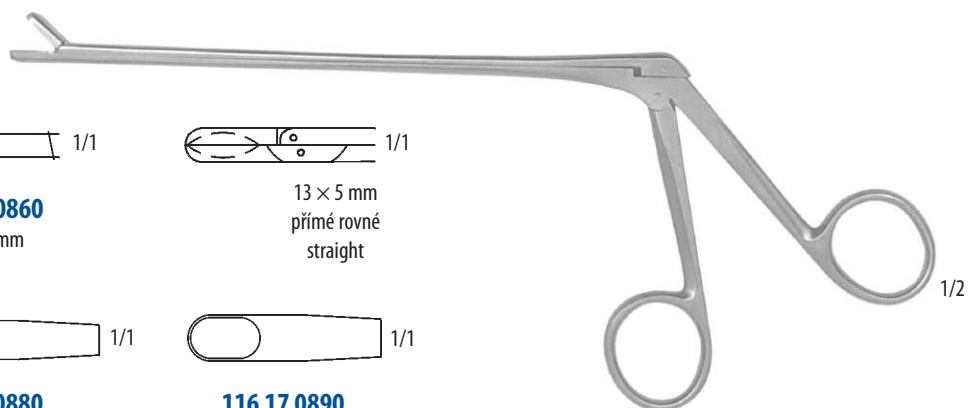
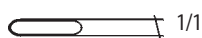
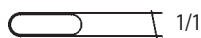
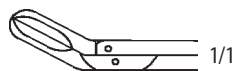
 13 × 5 mm
 přímé rovné
 straight

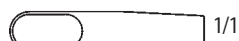
116 17 0870
 13 × 4 mm

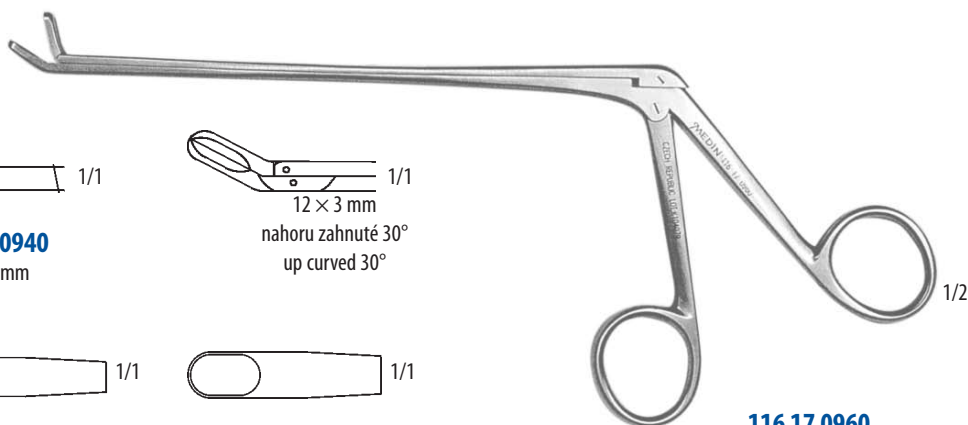
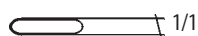
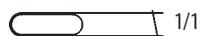
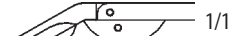
116 17 0880
 13 × 5 mm

116 17 0890
 12 × 6 mm

116 17 0880
 délka ramene – length of arm
 18,0 cm

116 17 0920
 12 × 2 mm

116 17 0940
 12 × 3 mm

 12 × 3 mm
 nahoru zahnuté 30°
 up curved 30°

116 17 0950
 13 × 4 mm

116 17 0960
 13 × 5 mm

116 17 0970
 12 × 6 mm

116 17 0960
 délka ramene – length of arm
 18,0 cm

116 17 1000
 12 × 2 mm

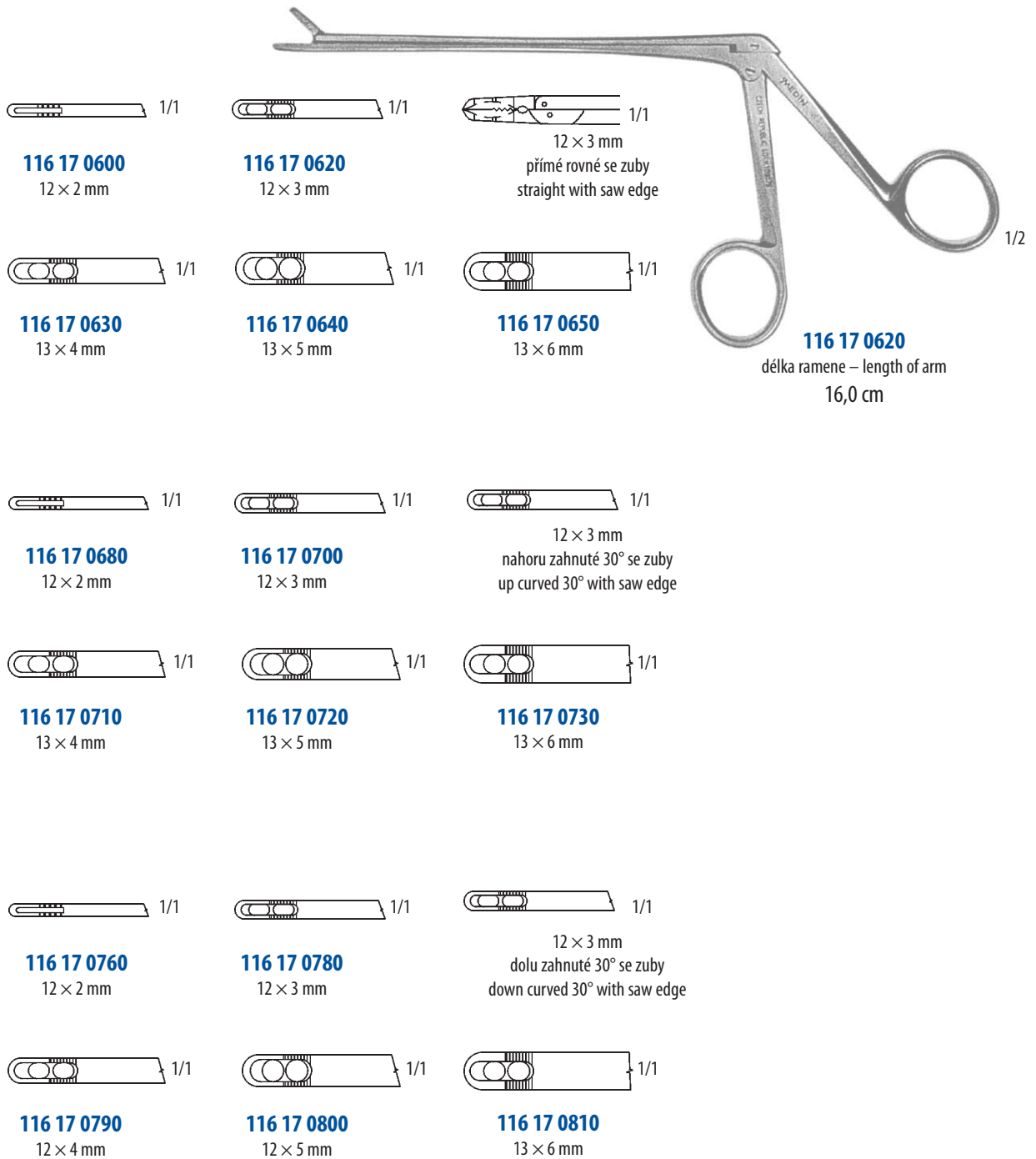
116 17 1020
 12 × 3 mm

 12 × 3 mm
 dolů zahnuté 30°
 down curved 30°

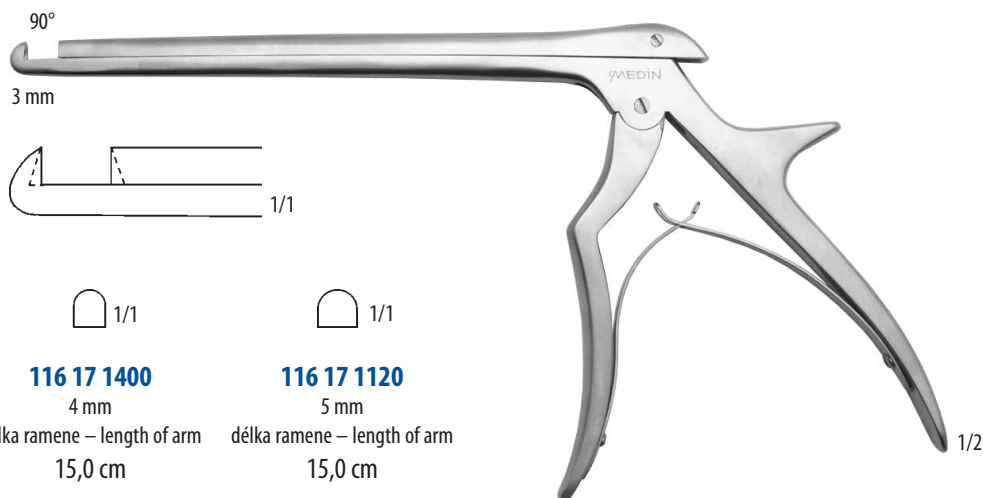
116 17 1030
 12 × 4 mm

116 17 1040
 12 × 5 mm

116 17 1050
 12 × 6 mm



**116 17 1110**

3 mm

délka ramene – length of arm
15,0 cm**116 17 1400**

4 mm

délka ramene – length of arm
15,0 cm**116 17 1120**

5 mm

délka ramene – length of arm
15,0 cm**116 17 1210**

3 mm

délka ramene – length of arm
18,0 cm**116 17 1410**

4 mm

délka ramene – length of arm
18,0 cm**116 17 1220**

5 mm

délka ramene – length of arm
18,0 cm**FERRIS-SMITH-KERRISON****116 17 1210**délka ramene – length of arm
18,0 cm**116 17 1310**

3 mm

délka ramene – length of arm
20,0 cm**116 17 1420**

4 mm

délka ramene – length of arm
20,0 cm**116 17 1320**

5 mm

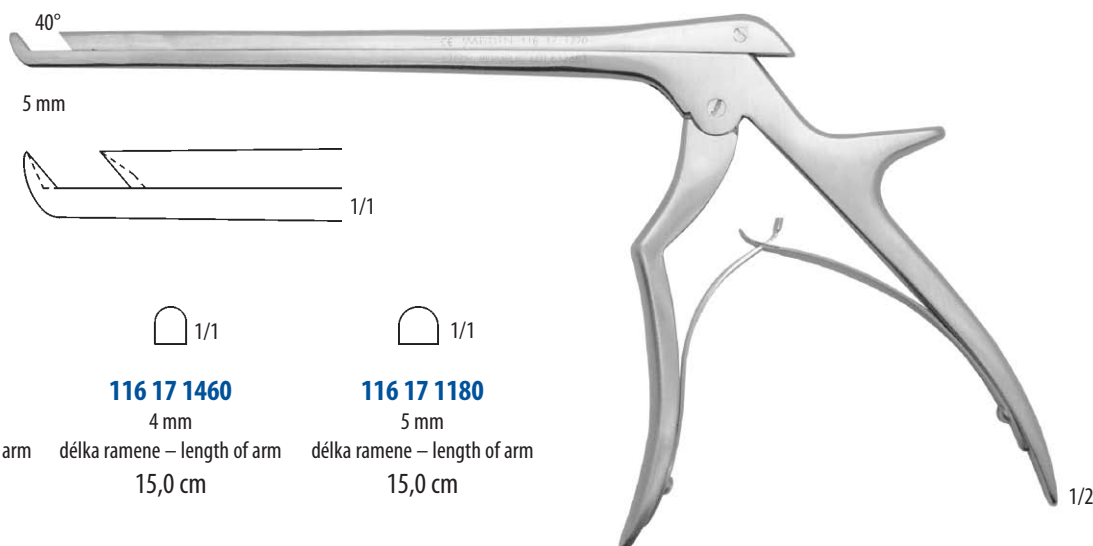
délka ramene – length of arm
20,0 cm**116 17 1170**

3 mm

délka ramene – length of arm
15,0 cm**116 17 1460**

4 mm

délka ramene – length of arm
15,0 cm**116 17 1180**

5 mm

délka ramene – length of arm
15,0 cm**116 17 1270**

3 mm

délka ramene – length of arm
18,0 cm**116 17 1470**

4 mm

délka ramene – length of arm
18,0 cm**116 17 1280**

5 mm

délka ramene – length of arm
18,0 cm**KERRISON****116 17 1270**délka ramene – length of arm
20,0 cm**116 17 1370**

3 mm

délka ramene – length of arm
20,0 cm**116 17 1480**

4 mm

délka ramene – length of arm
20,0 cm**116 17 1380**

5 mm

délka ramene – length of arm
20,0 cm



1/2

KERRISON
116 91 0317

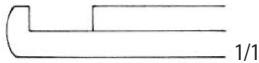
 délka ramene – length of arm
 18,0 cm

 1/1
 1 mm

116 91 0312

 délka ramene – length of arm
 15,0 cm

 1/1
 2 mm

116 91 0313

 délka ramene – length of arm
 15,0 cm

116 91 0316

 délka ramene – length of arm
 18,0 cm

116 91 0317

 délka ramene – length of arm
 18,0 cm

116 91 0328

 délka ramene – length of arm
 20,0 cm

116 91 0329

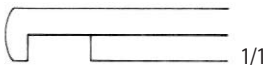
 délka ramene – length of arm
 20,0 cm

 1/1
 1 mm

116 91 0337

 délka ramene – length of arm
 15,0 cm

 1/1
 2 mm

116 91 0338

 délka ramene – length of arm
 15,0 cm

 1/1
 3 mm

116 91 0339

 délka ramene – length of arm
 15,0 cm

 1/1
 5 mm

116 91 0340

 délka ramene – length of arm
 15,0 cm

116 91 0341

 délka ramene – length of arm
 18,0 cm

116 91 0342

 délka ramene – length of arm
 18,0 cm

116 91 0343

 délka ramene – length of arm
 18,0 cm

116 91 0344

 délka ramene – length of arm
 18,0 cm

116 91 0349

 délka ramene – length of arm
 20,0 cm

116 91 0350

 délka ramene – length of arm
 20,0 cm

116 91 0351

 délka ramene – length of arm
 20,0 cm

116 91 0352

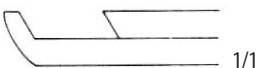
 délka ramene – length of arm
 20,0 cm

 1/1
 1 mm

116 91 0357

 délka ramene – length of arm
 15,0 cm

 1/1
 2 mm

116 91 0358

 délka ramene – length of arm
 15,0 cm

116 91 0361

 délka ramene – length of arm
 18,0 cm

116 91 0362

 délka ramene – length of arm
 18,0 cm

116 91 0370

 délka ramene – length of arm
 20,0 cm

116 91 0371

 délka ramene – length of arm
 20,0 cm



HARTMANN
116 29 0010
14,2 cm



HARTMANN
116 29 0030
14,2 cm

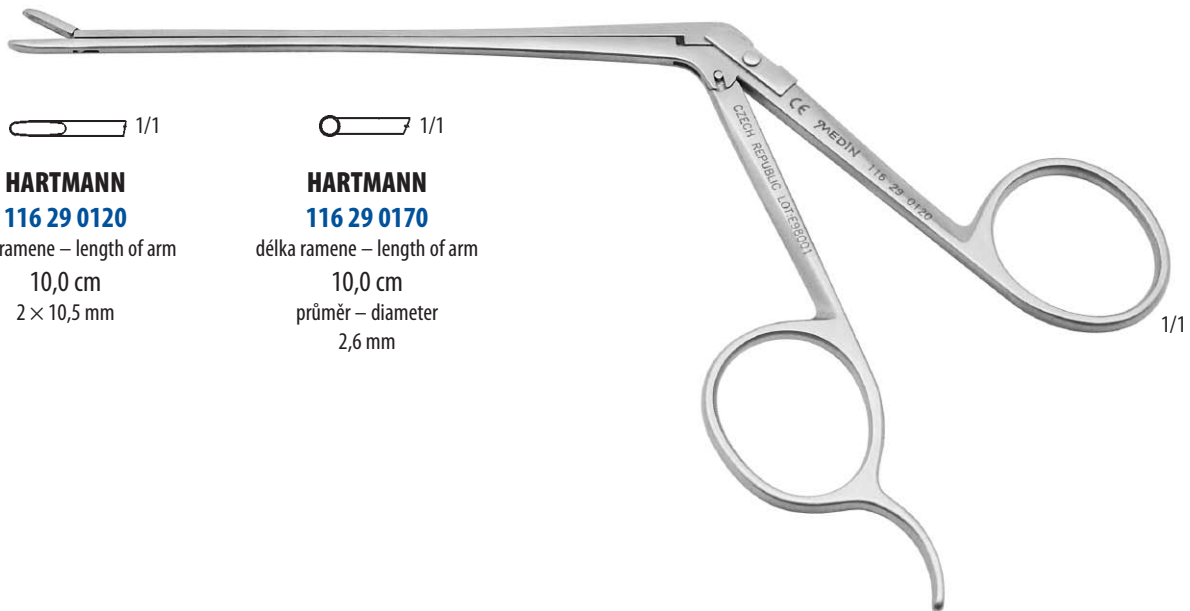



STRÜMPEL

116 29 0300

délka ramene – length of arm

10,0 cm

2,2 × 7,0 mm

KLEŠTĚ UŠNÍ ŠTÍPACÍ
MASTOID FORCEPS



JANSEN
rovné – straight
116 29 0400
18,0 cm
Fig. 1

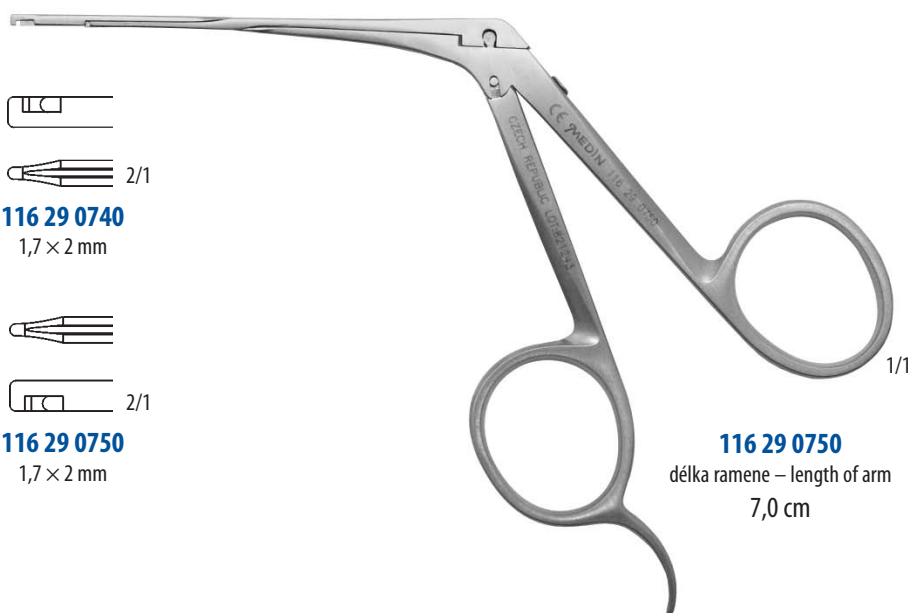

JANSEN
zahnuté – curved
116 29 0410
18,0 cm
Fig. 2

KLEŠTĚ UŠNÍ ŠTÍPACÍ
MASTOID FORCEPS



1/2

116 91 0001

14,5 cm

 pro měkký drát do průměru 1,5 mm
 for soft wires up to diameter 1,5 mm

 pro tvrdý drát do průměru 1,0 mm
 for hard wires up to diameter 1,0 mm

1/2

116 91 0004

18,0 cm

 pro měkký drát do průměru 2,0 mm
 for soft wires up to diameter 2,0 mm

1/1

1/2

116 91 0005

17,0 cm

 pro tvrdý drát do průměru 1,5 mm
 for hard wires up to diameter 1,5 mm



1/1

1/2

116 91 0006

22,0 cm

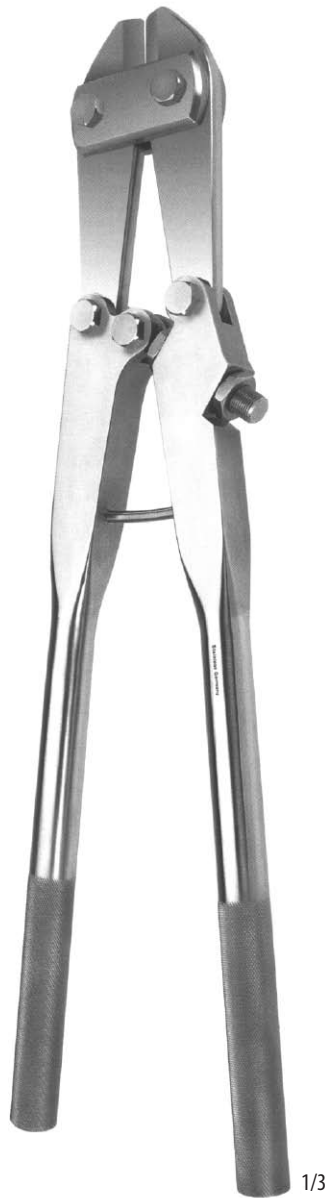
 do průměru 2,5 mm
 for wires up to diameter 2,5 mm

**116 91 0007**

47,0 cm

pro dráty, šrouby a hřebíky do průměru 6,0 mm
for wires, screws and nails up to diameter 6,0 mm



SADA GUMOVÝCH ČELISTÍ PRO 116 91 0008, 0539
SET OF RUBBER JAWS FOR 116 91 0008, 0539

116 91 0540

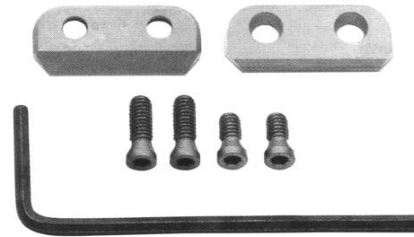

SADA ČELISTÍ PRO ŠTÍPACÍ KLEŠTĚ 116 91 0008
SET OF JAWS FOR WIRE FORCEPS 116 91 0008

116 91 0009

SADA ČELISTÍ PRO ŠTÍPACÍ KLEŠTĚ 116 91 0539
SET OF JAWS FOR WIRE FORCEPS 116 91 0539

116 91 0541



1/2

HERCULES
116 91 0008

28,0 cm
do průměru 4,0 mm
for wires up to diameter 4,0 mm



1/2

HERCULES
116 91 0539

23,0 cm
do průměru 3,0 mm
for wires up to diameter 3,0 mm

**116 91 0010**

21,5 cm

pro tvrdý drát do průměru 2,5 mm
for hard wires up to diameter 2,5 mm**116 91 0011**

23,0 cm

pro tvrdý drát do průměru 2,2 mm
for hard wires up to diameter 2,2 mm

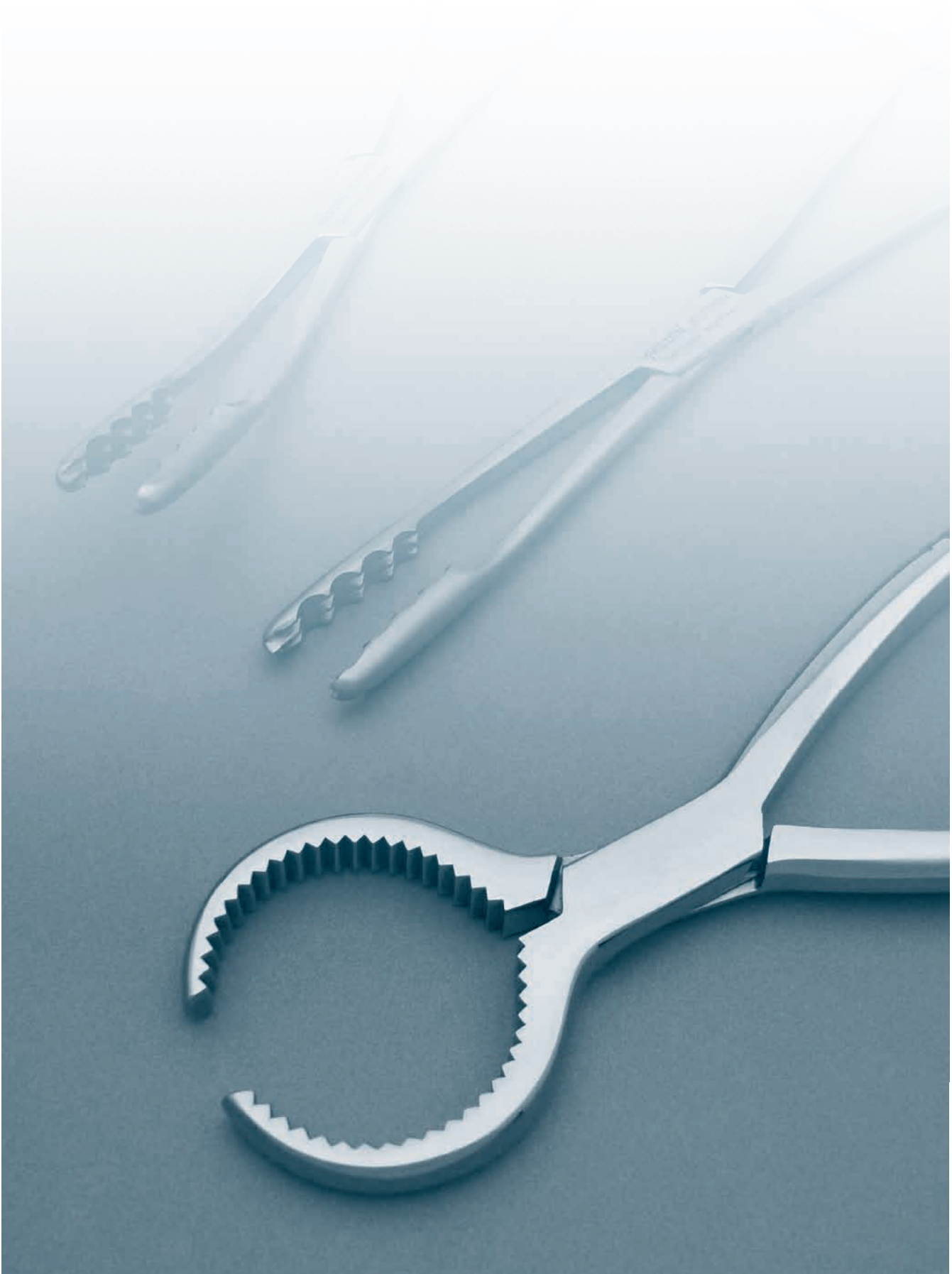





HENNING
117 91 0063
28,0 cm



WOLFF
117 91 0066 – 18,0 cm
117 91 0067 – 24,0 cm
117 05 0010 – 25,5 cm



BEESON
117 91 0064
30,0 cm

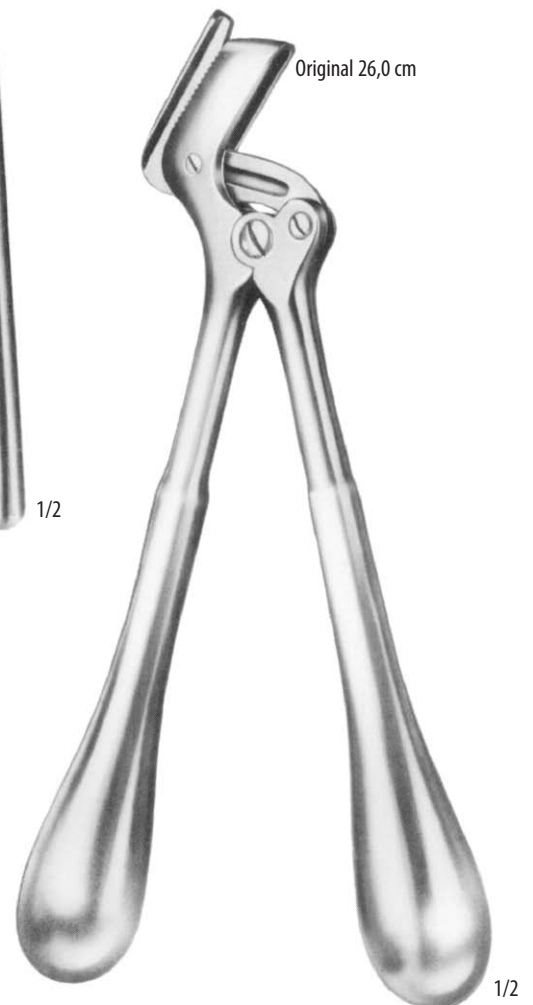

STILLE
117 91 0069 – 23,0 cm
117 91 0070 – 26,0 cm
117 91 0071 – 37,0 cm

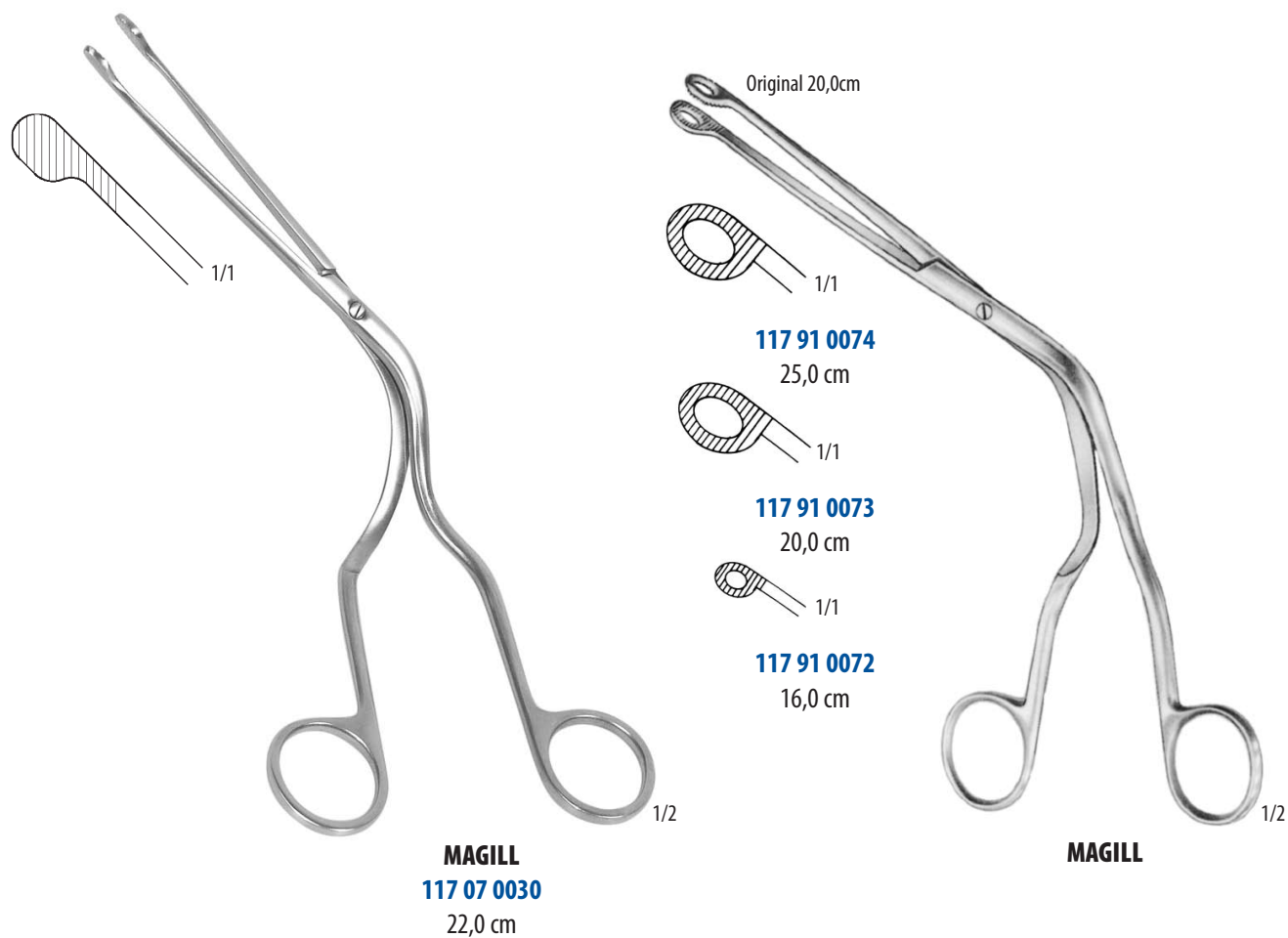
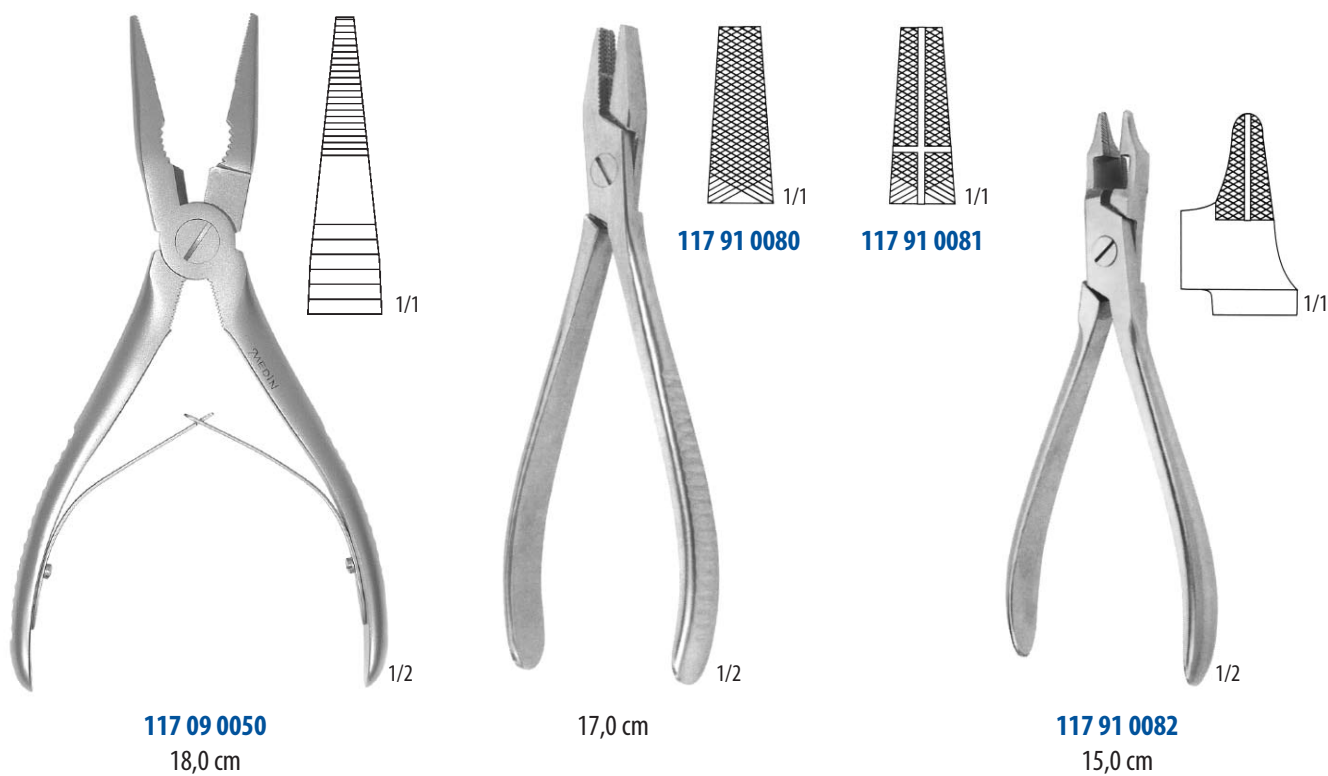
KLEŠTĚ ÚCHOPNÉ
GRASPING FORCEPSKLEŠTĚ ÚCHOPNÉ NA DRÁT
WIRE GRASPING FORCEPS

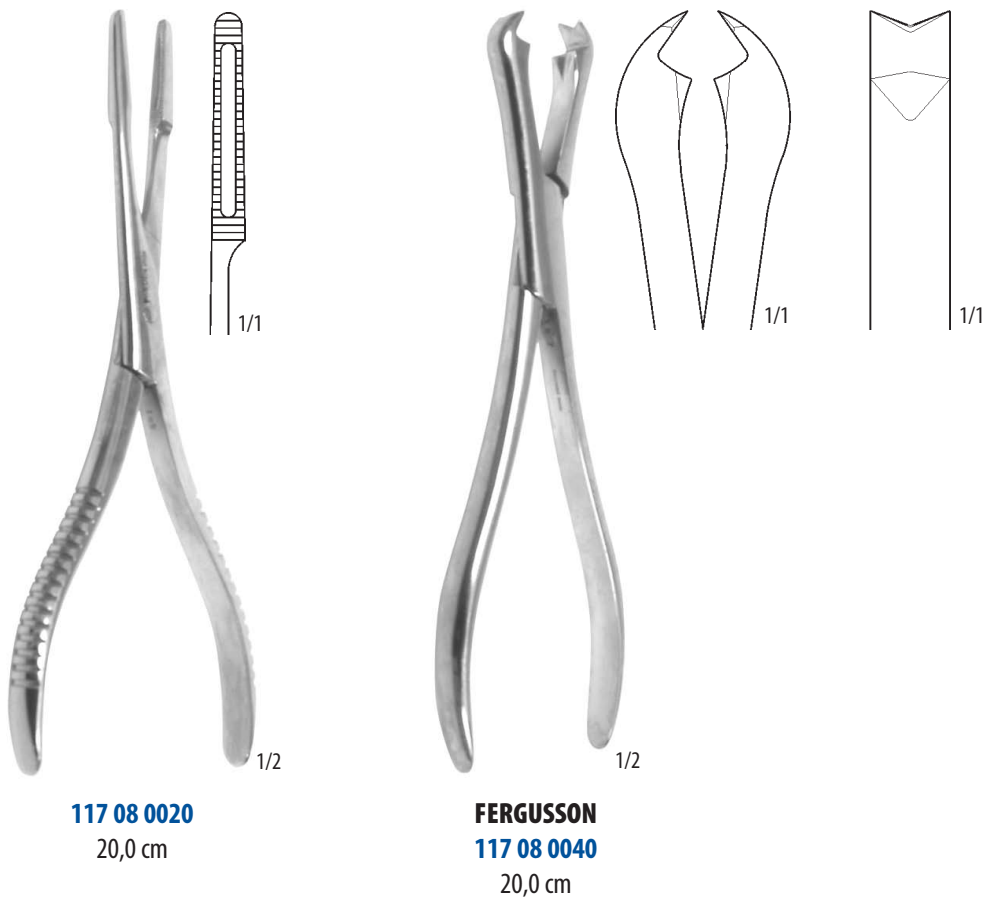
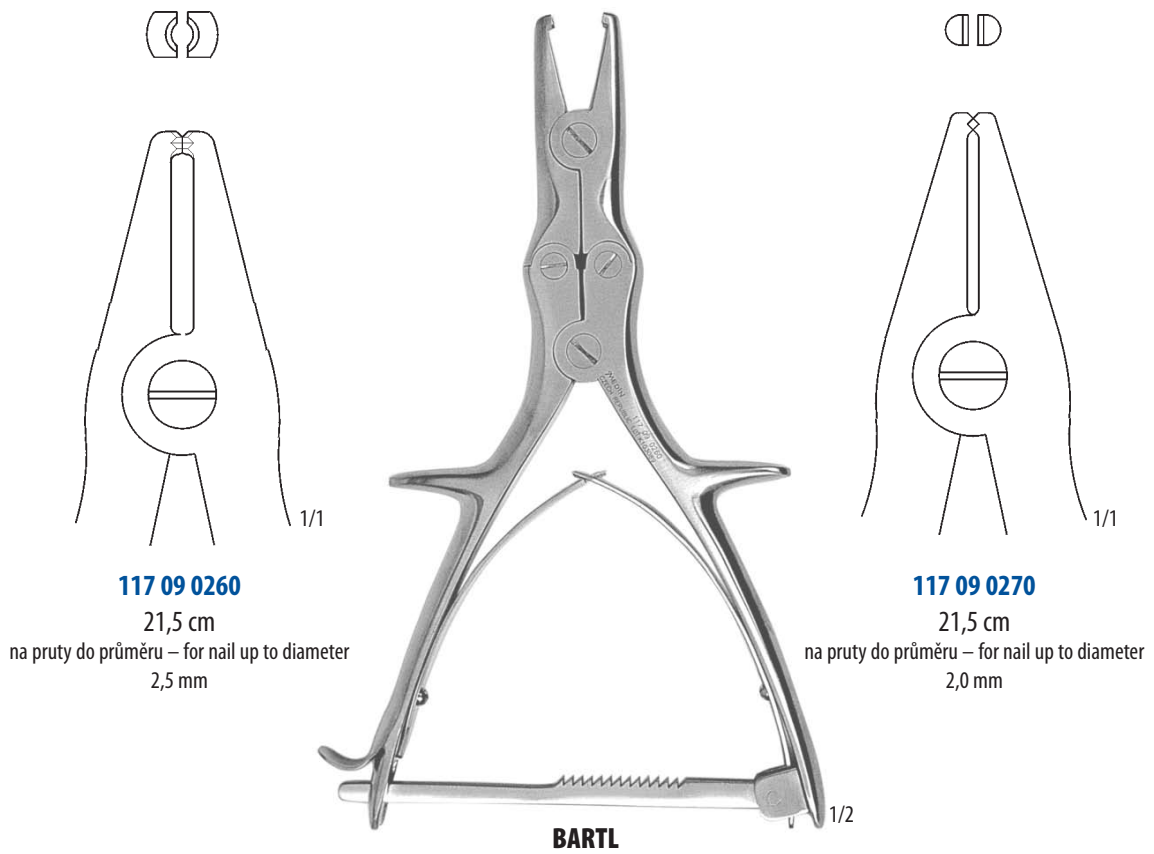



117 99 0039
23,5 cm

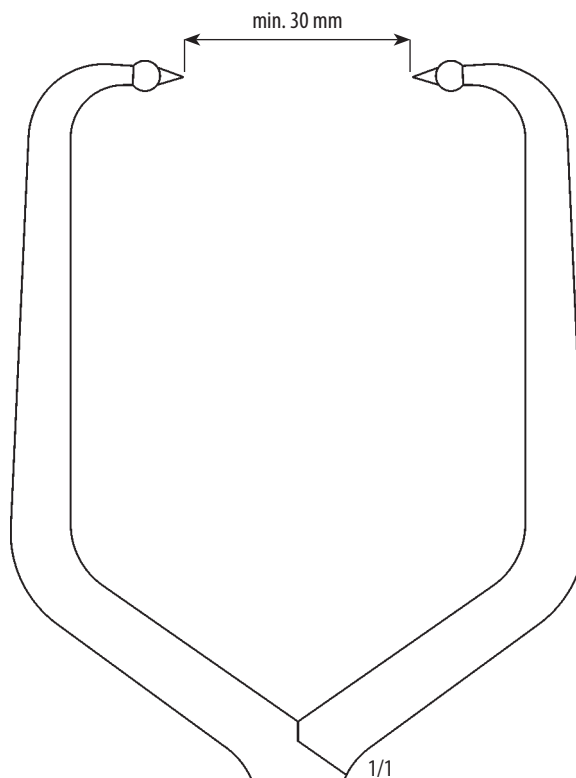

117 99 0039
23,5 cm
s kuličkou Ø 4 mm
with ball Ø 4 mm

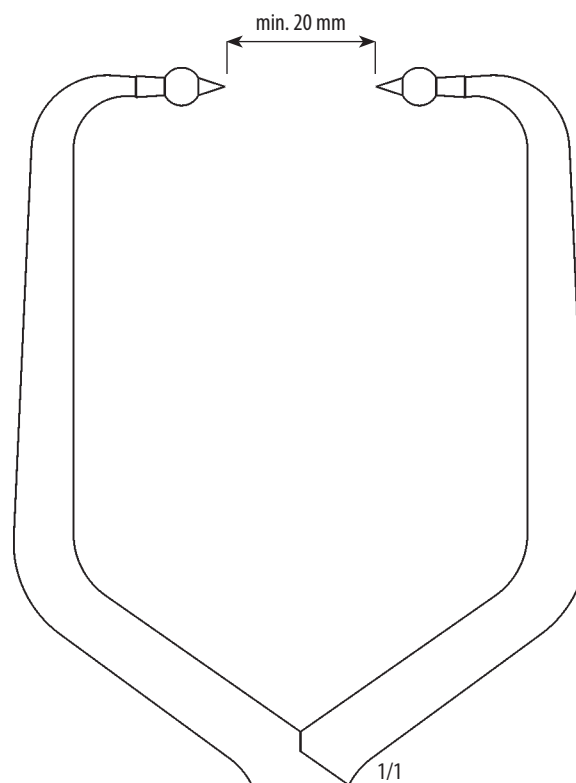

117 99 0044
23,5 cm
s kuličkou Ø 5 mm
with ball Ø 5 mm

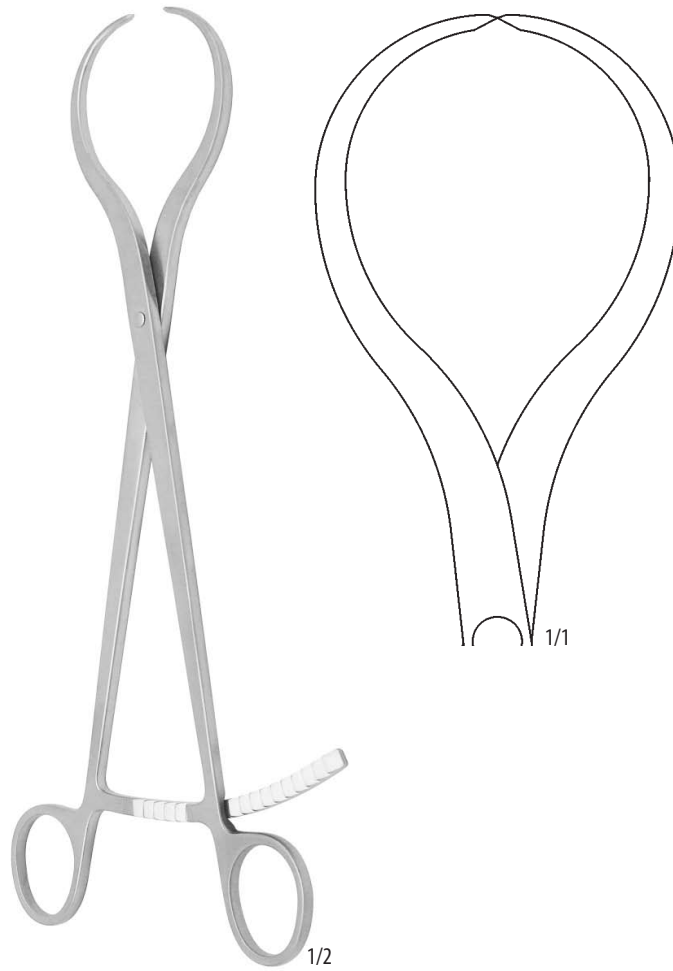

KLEŠTĚ NA DRŽENÍ KOSTÍ STAVĚCÍ
BONE FORCEPS
117 99 0041
25,0 cm

KLEŠTĚ NA DRŽENÍ KOSTÍ
BONE HOLDING FORCEPS

117 09 0150
17,3 cm

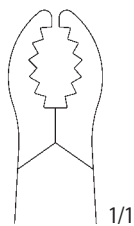

117 09 0140
17,3 cm
Ø 5 mm

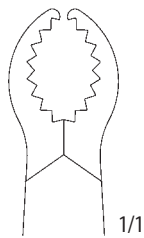

117 09 0150
17,3 cm
Ø 8 mm

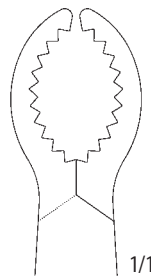

117 09 0130
17,3 cm
Ø 10 mm

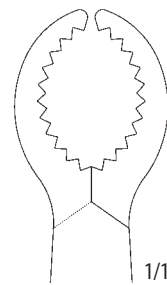

117 09 0160
17,3 cm
Ø 12 mm



NOVÁK
117 09 0190
19,0 cm

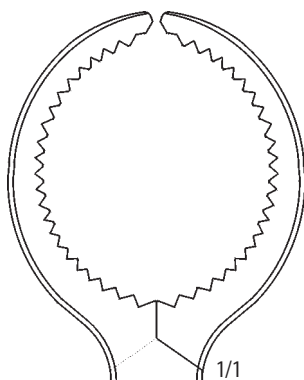

117 09 0190
19,0 cm
Ø 30 mm

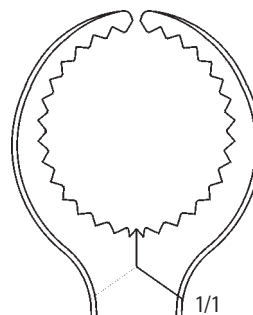

117 09 0180
18,0 cm
Ø 24 mm

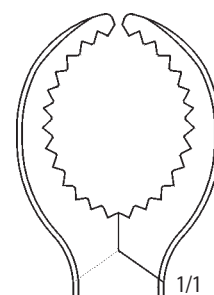

117 09 0170
18,0 cm
Ø 18 mm



117 91 0134
19,0 cm

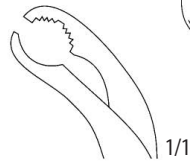

117 91 0133
15,0 cm

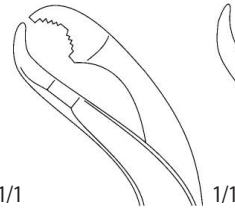

117 91 0134
19,0 cm

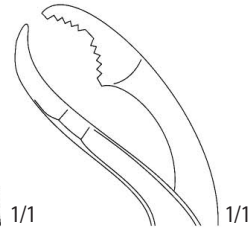

117 91 0135
24,0 cm

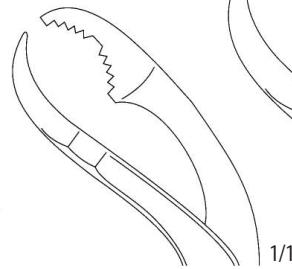

117 91 0136
26,0 cm

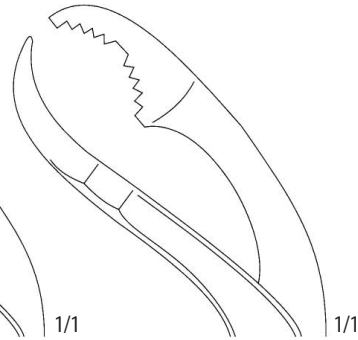

117 91 0137
28,0 cm

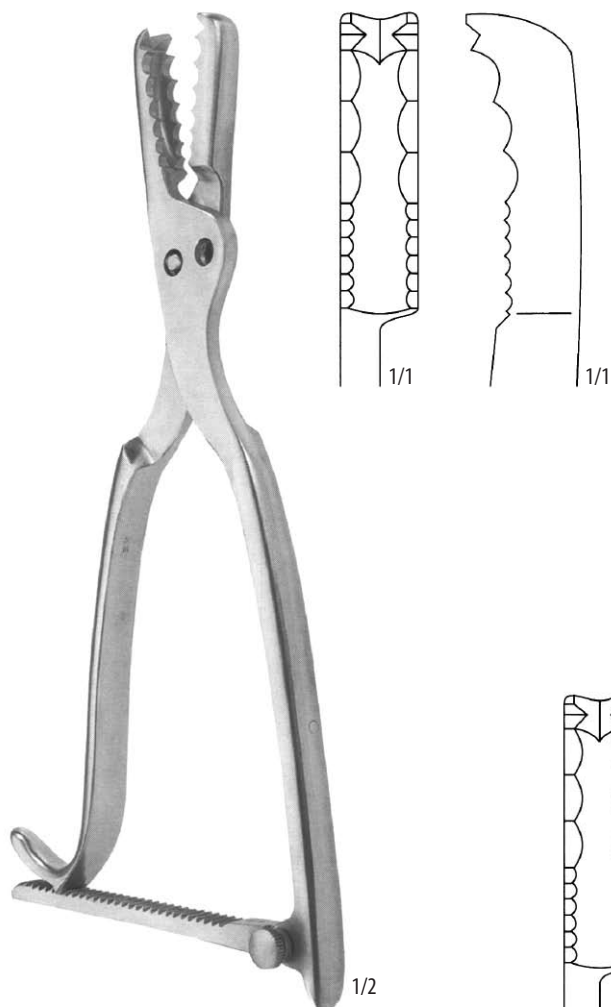
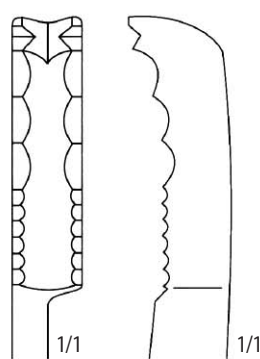
**FARABEUF-LAMBOTTE****117 91 0117**26,0 cm
11,0 mm**117 91 0118**23,0 cm
9,0 mm**117 91 0119**26,0 cm
11,0 mm**FARABEUF**
117 91 0118

23,0 cm



VERBRUGGE
117 91 0122
26,0 cm

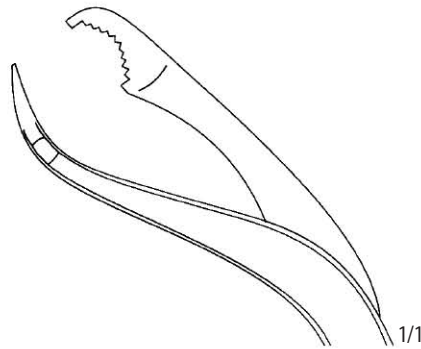

117 91 0120
17,5 cm
5,0 mm

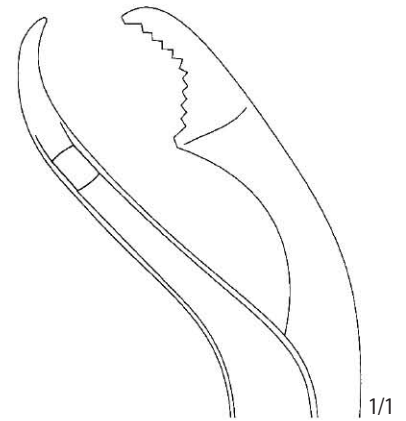

117 91 0121
25,0 cm
9,5 mm

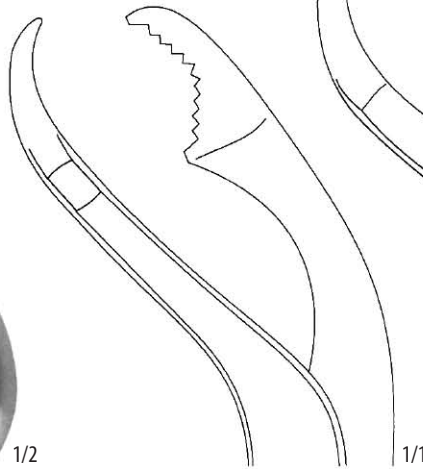

117 91 0122
26,0 cm
10,5 mm

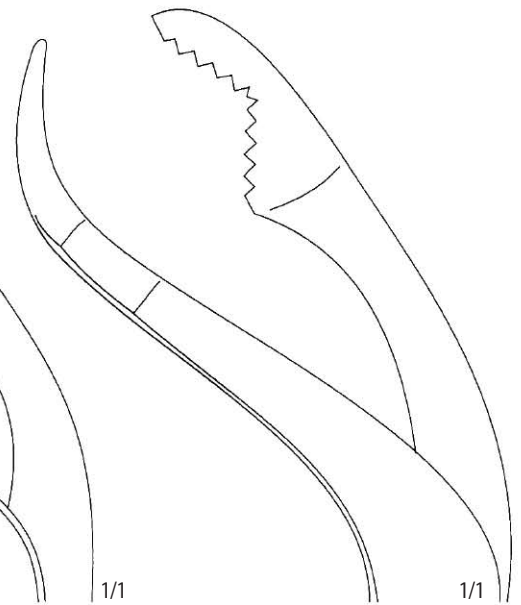

117 91 0123
27,0 cm
12,0 mm

KLEŠTĚ NA PLÍCE
LUNG GRASPING FORCEPS

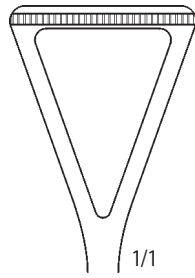

DUVAL
117 14 0130
 22,0 cm

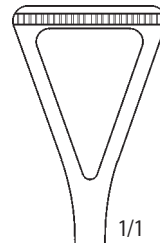

117 14 0130
 26 mm
 22,0 cm

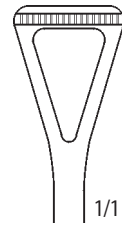

117 14 0120
 21 mm
 22,0 cm



117 14 0110
 16 mm
 22,0 cm

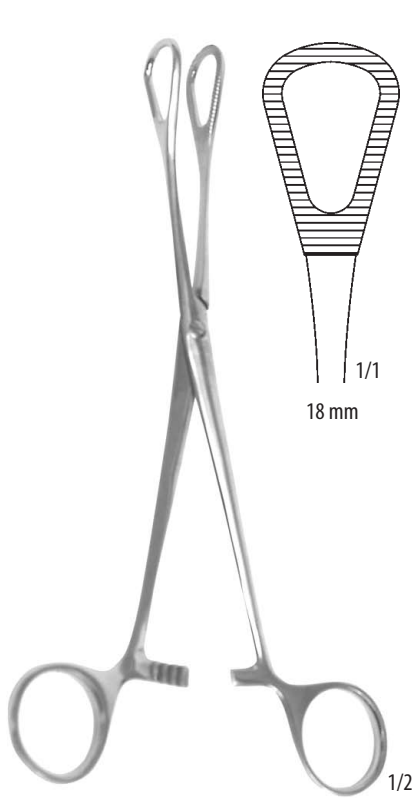

117 19 0020
20,0 cm

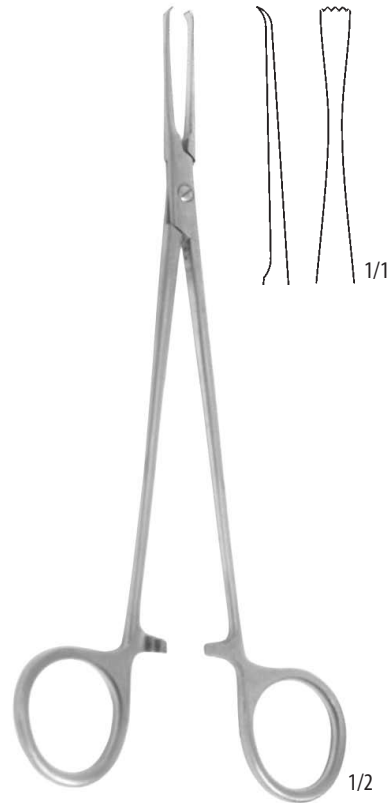

ALLIS
117 19 0070
21,0 cm

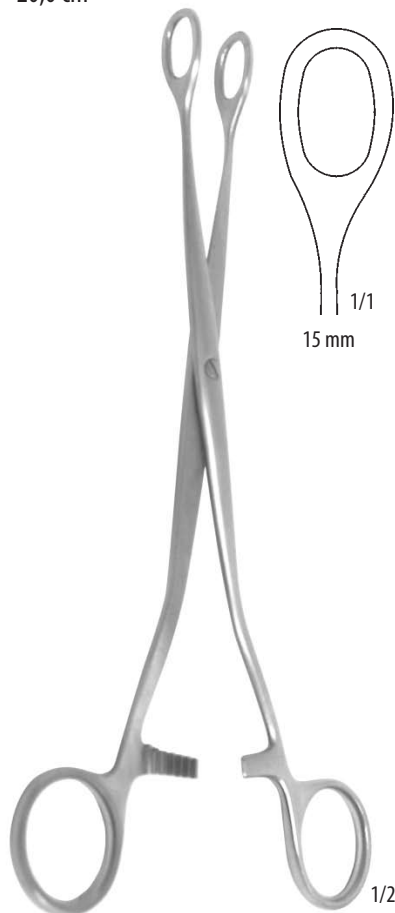

COLLIN
117 22 0150
24,0 cm

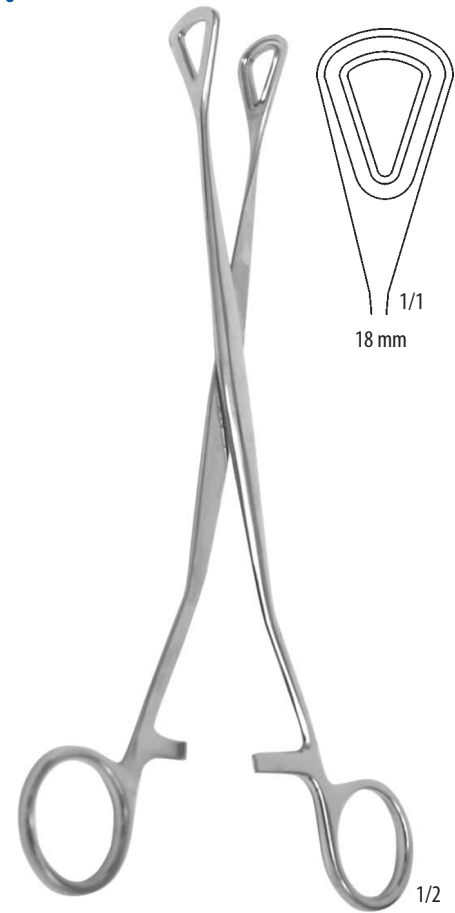

COLLIN
117 22 0160
24,0 cm

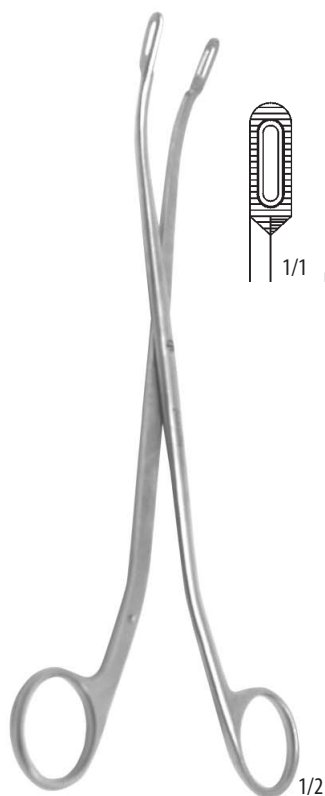
KLEŠTĚ NA LEDVINOVÉ KAMENY
KIDNEY STONE FORCEPS

RANDALL
117 22 0270
21,0 cm
Fig. 1

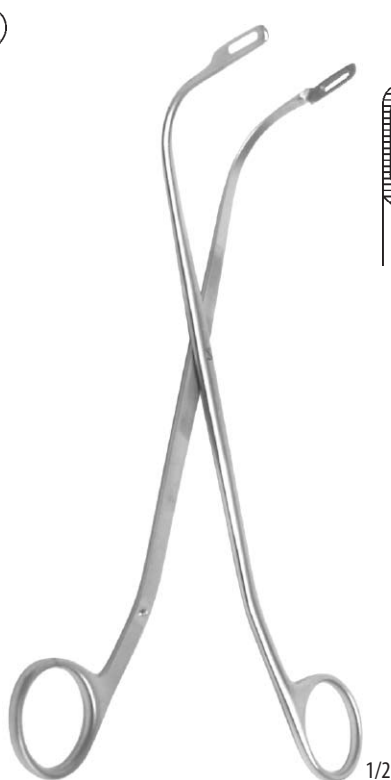

RANDALL
117 22 0280
19,8 cm
Fig. 2

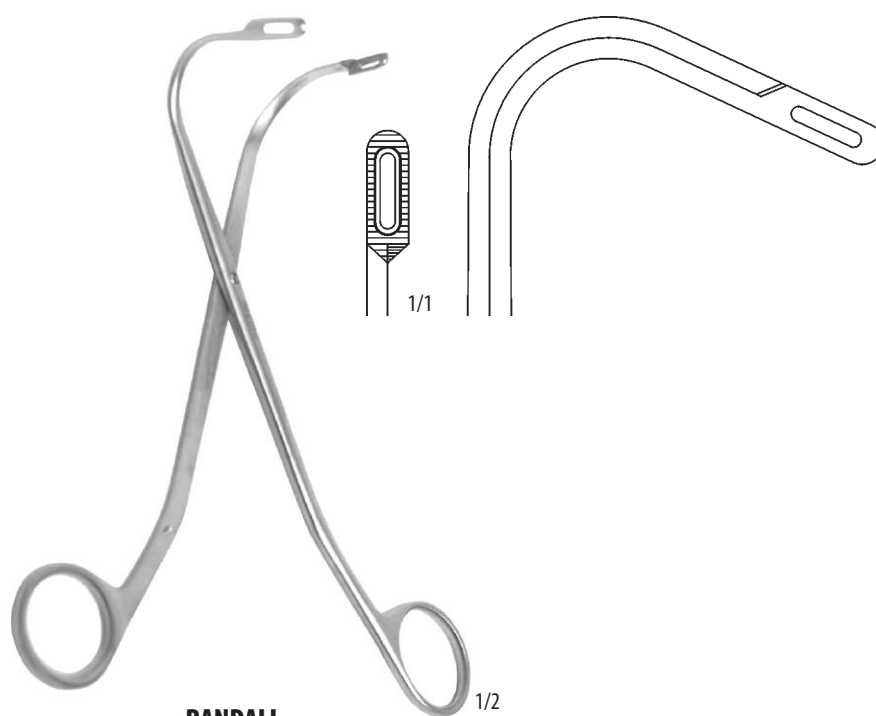

RANDALL
117 22 0290
18,5 cm
Fig. 3

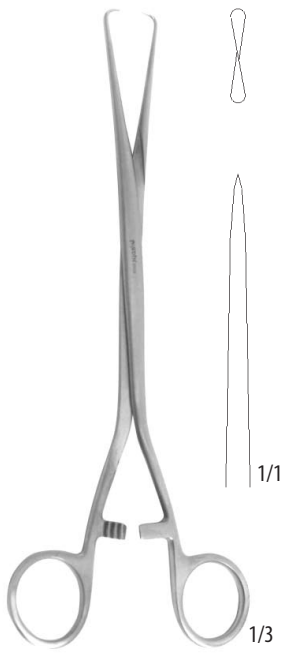

SCHRÖDER
117 27 0010
25,0 cm

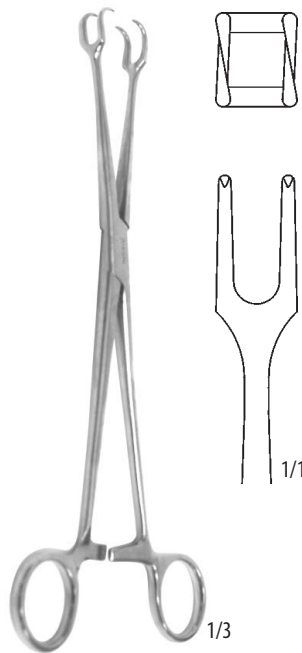

117 27 0020
25,0 cm

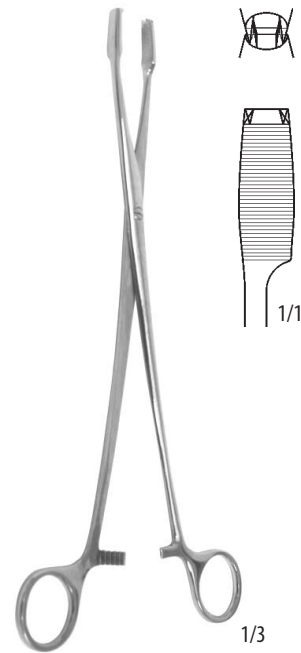

117 27 0050
25,0 cm

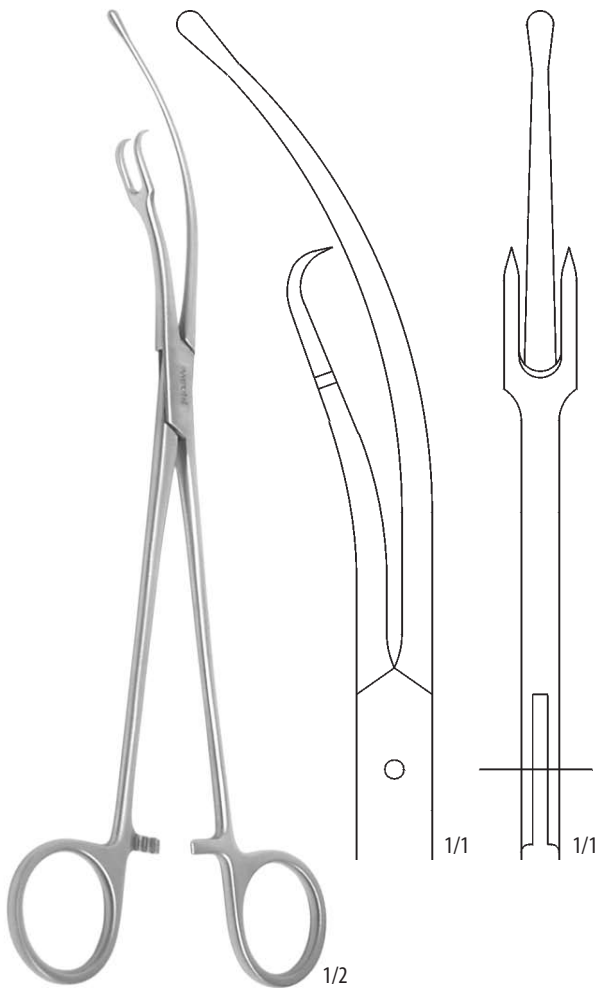

117 27 0150
26,0 cm

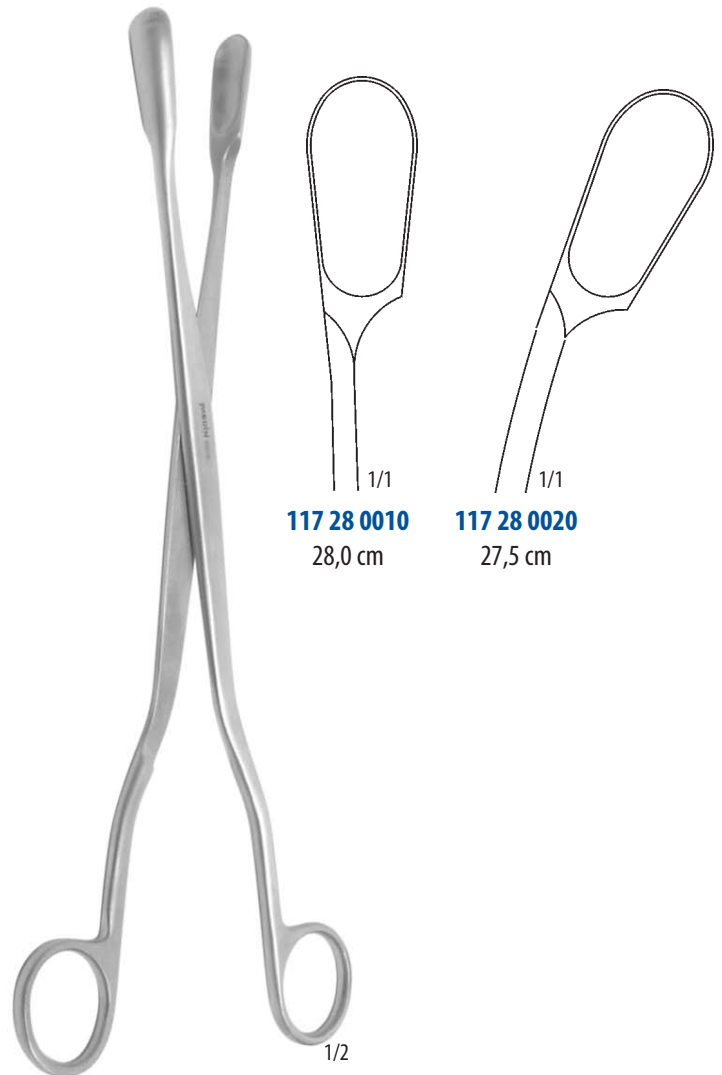

117 28 0010
28,0 cm

117 28 0020
27,5 cm

WINTER

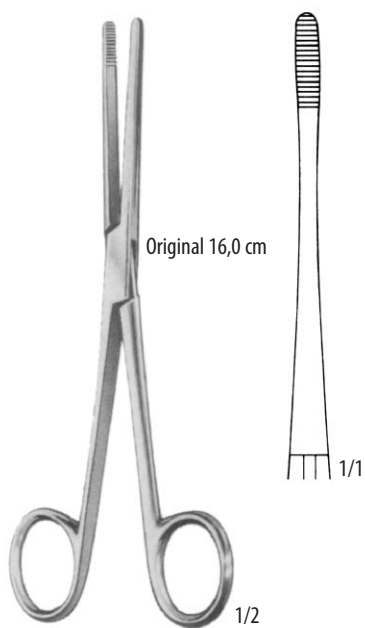
**LISTER**

- 117 91 0001** – 13,0 cm
- 117 91 0002** – 16,0 cm
- 117 91 0003** – 18,0 cm

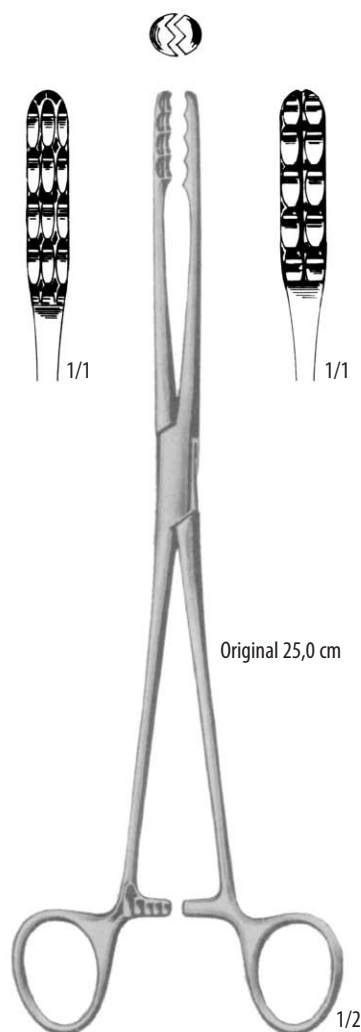
**ULRICH**

- 117 91 0004** – 22,0 cm
- 117 91 0005** – 25,0 cm

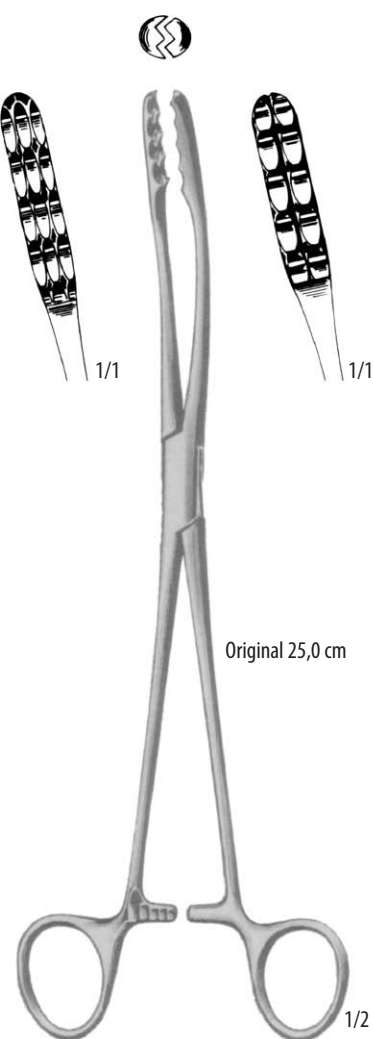
**ULRICH**

- 117 91 0007** – 22,0 cm
- 117 91 0008** – 25,0 cm

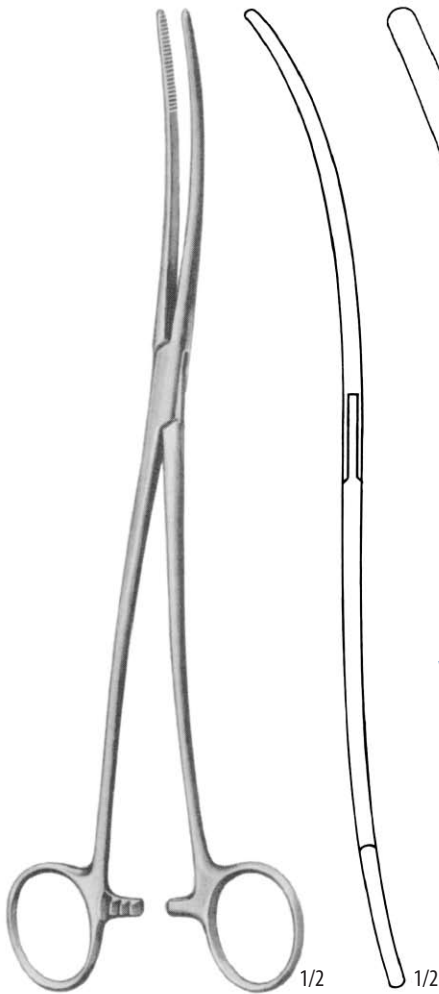

BOZEMANN

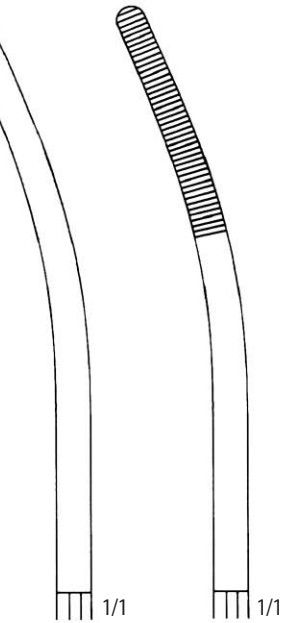

117 27 0500
25,0 cm

117 27 0510
25,0 cm



COLLIN
117 91 0033
24,0 cm



NOTTO
117 91 0034
27,5 cm



PELKMANN
117 91 0035
25,0 cm

KELLY
117 91 0037
32,0 cm

HEYWOOD-SMITH
117 91 0038
21,0 cm

HEYWOOD-SMITH
117 91 0039
25,0 cm



GROSS-MAIER
117 27 0260
26,0 cm

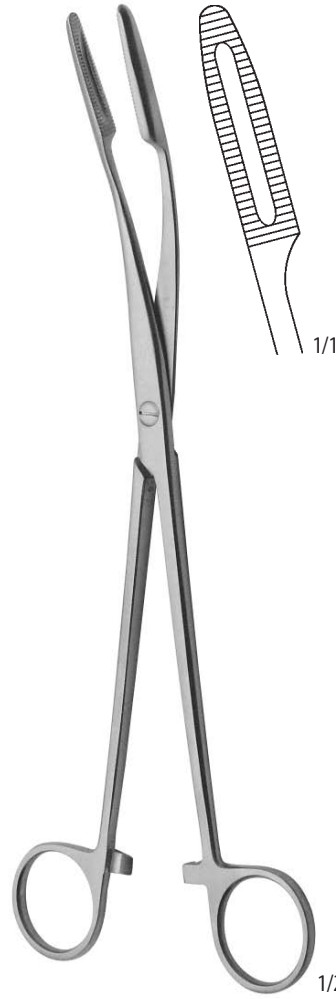

GROSS-MAIER
117 27 0280
25,7 cm

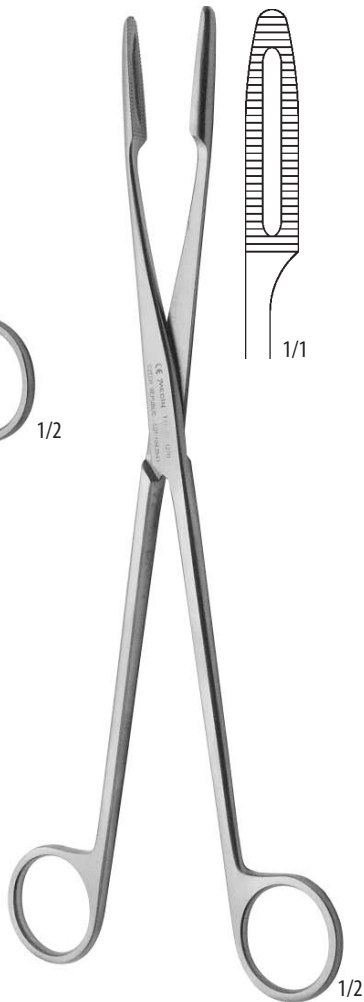

117 27 0270
26,0 cm

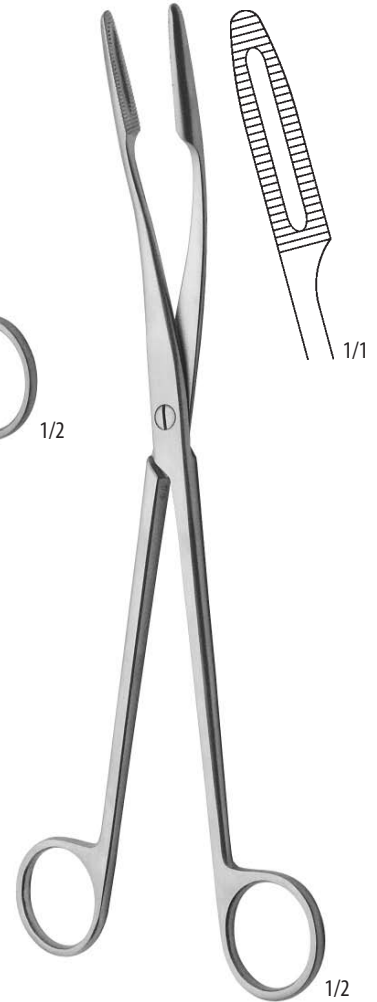

117 27 0290
25,7 cm

**FOERSTER-BALLENGER**

18,0 cm

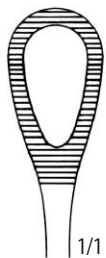

117 91 0042

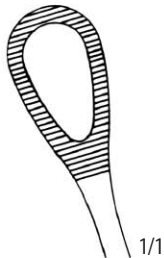

117 91 0045



117 91 0048

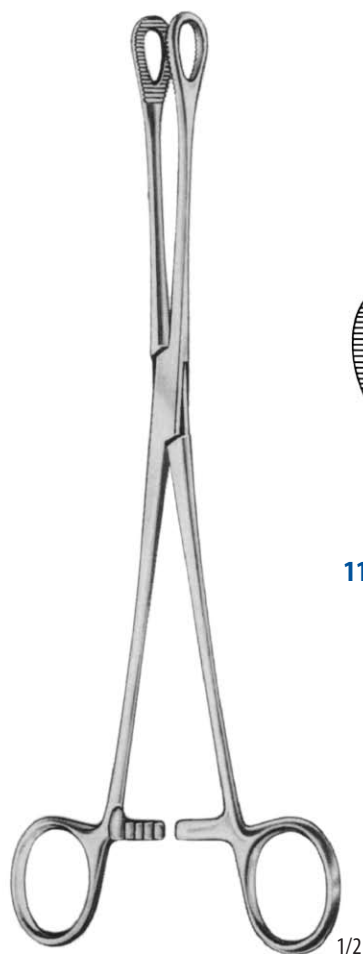

117 91 0051

**FOERSTER-BALLENGER**

25,0 cm



117 91 0044

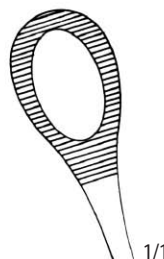

117 91 0047

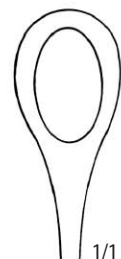

117 91 0050

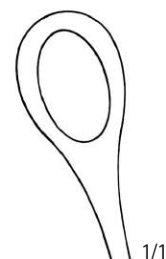

117 91 0053

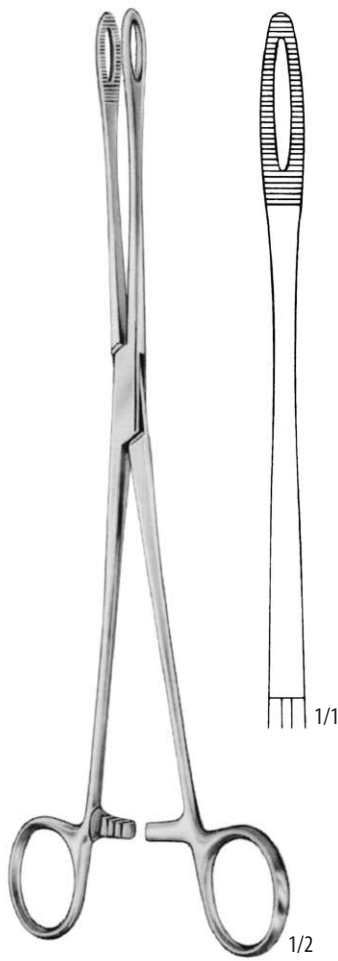

FOERSTER
25,0 cm

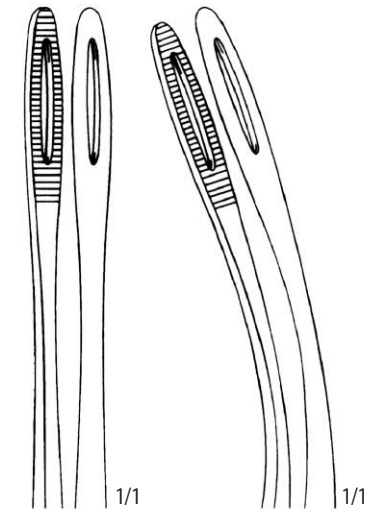

117 91 0054

117 91 0055

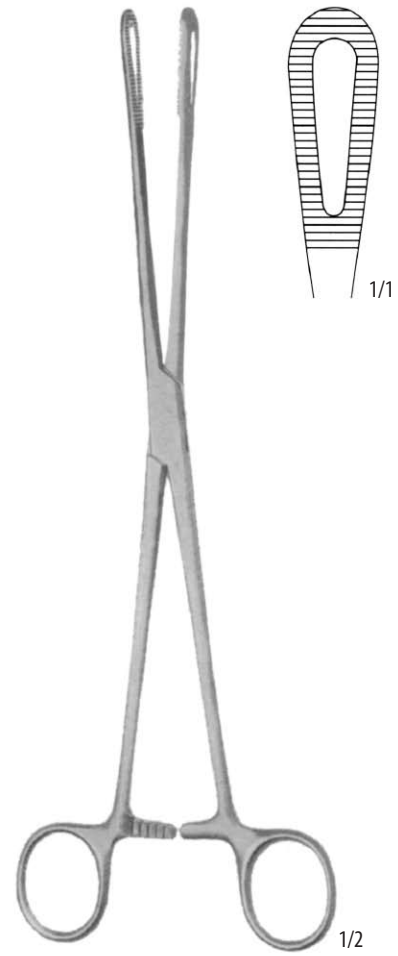

RAMPLEY
117 91 0056
25,0 cm

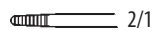

117 29 0060
0,6 × 0,9 × 3,5 mm
délka ramene – length of arm
6,8 cm



117 29 0070
0,6 × 0,9 × 5,5 mm
délka ramene – length of arm
7,0 cm

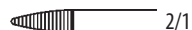

117 29 0090
1,5 × 4,5 mm
délka ramene – length of arm
7,8 cm

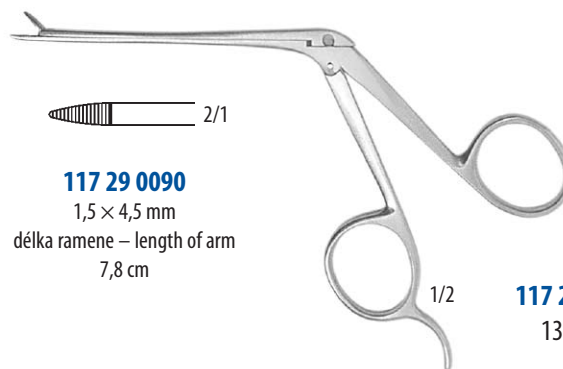

117 29 0060
13,0 cm



117 29 0100
2 × 7 mm
délka ramene – length of arm
8,3 cm

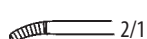

117 29 0130
zahnuté levé – left curved
0,6 × 0,9 × 3,5 mm
délka ramene – length of arm
6,8 cm



117 29 0140
zahnuté pravé – right curved
0,6 × 0,9 × 3,5 mm
délka ramene – length of arm
6,8 cm



117 29 0400
0,8 × 2 × 5 mm
délka ramene – length of arm
9,8 cm



117 29 0410
0,2 × 2 × 5 mm
délka ramene – length of arm
9,8 cm



117 29 0420
0,8 × 2 × 5 mm
délka ramene – length of arm
9,8 cm

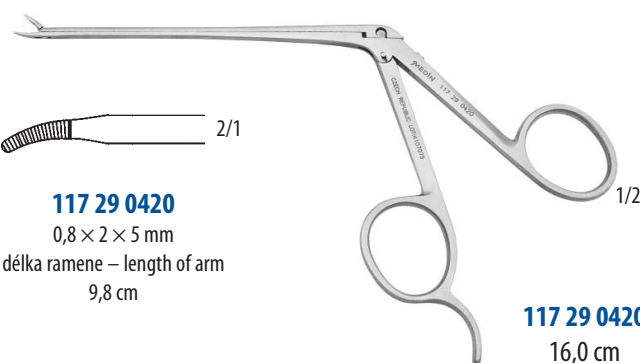

117 29 0420
16,0 cm



117 29 0430
0,8 × 2 × 5 mm
délka ramene – length of arm
9,8 cm



117 29 0440
0,5 × 2 × 5 mm
délka ramene – length of arm
9,8 cm



117 29 0450
0,8 × 2 × 8,5 mm
délka ramene – length of arm
10,2 cm

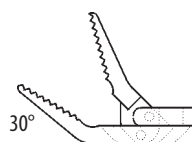

117 29 0460
0,8 × 2 × 5 mm
délka ramene – length of arm
9,8 cm



117 29 0470
1,2 × 2 × 5 mm
délka ramene – length of arm
9,8 cm



117 29 0480
1,5 × 2 × 8 mm
délka ramene – length of arm
9,8 cm
(1 × 2)



117 30 0100
3 mm

HARTMANN
20,4 cm

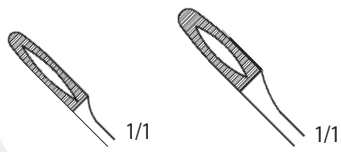

1/1

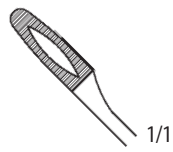

1/1

117 30 0110
4 mm

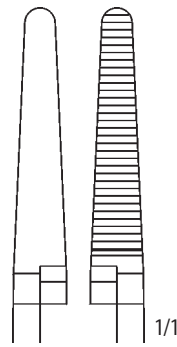

1/1

117 30 0400
4 mm

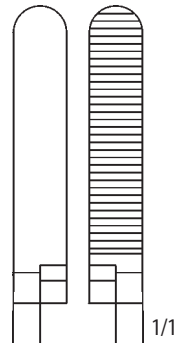
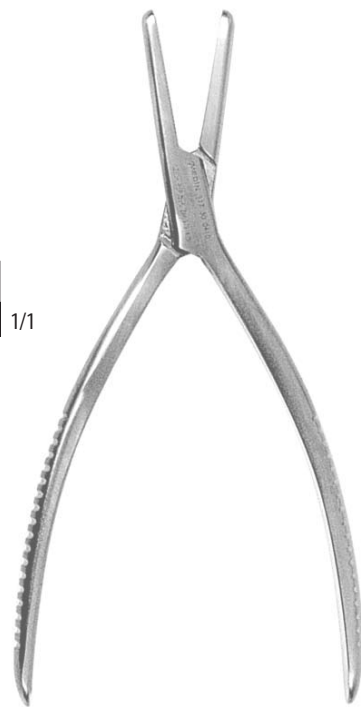

1/1

117 30 0410
7 mm

KLEŠTĚ NA NOSNÍ SKOŘEPU
NASAL SEPTUM FORCEPS
18,3 cm

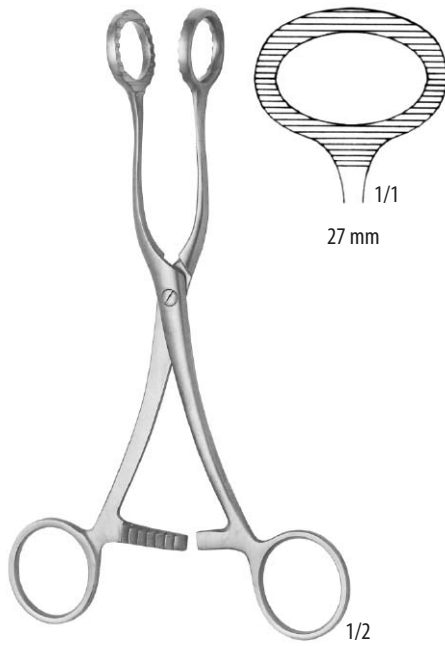

COLLIN
117 31 0010
16,7 cm

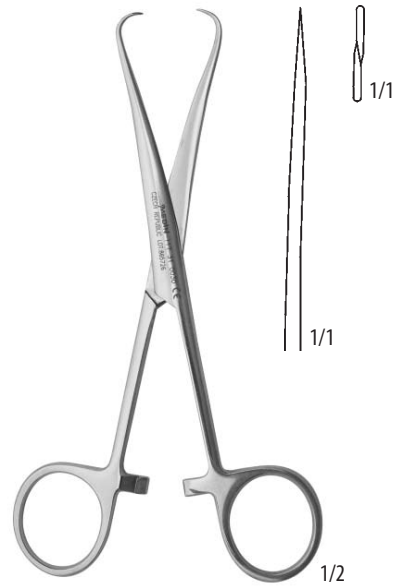

LÖBKER
117 31 0030
15,0 cm

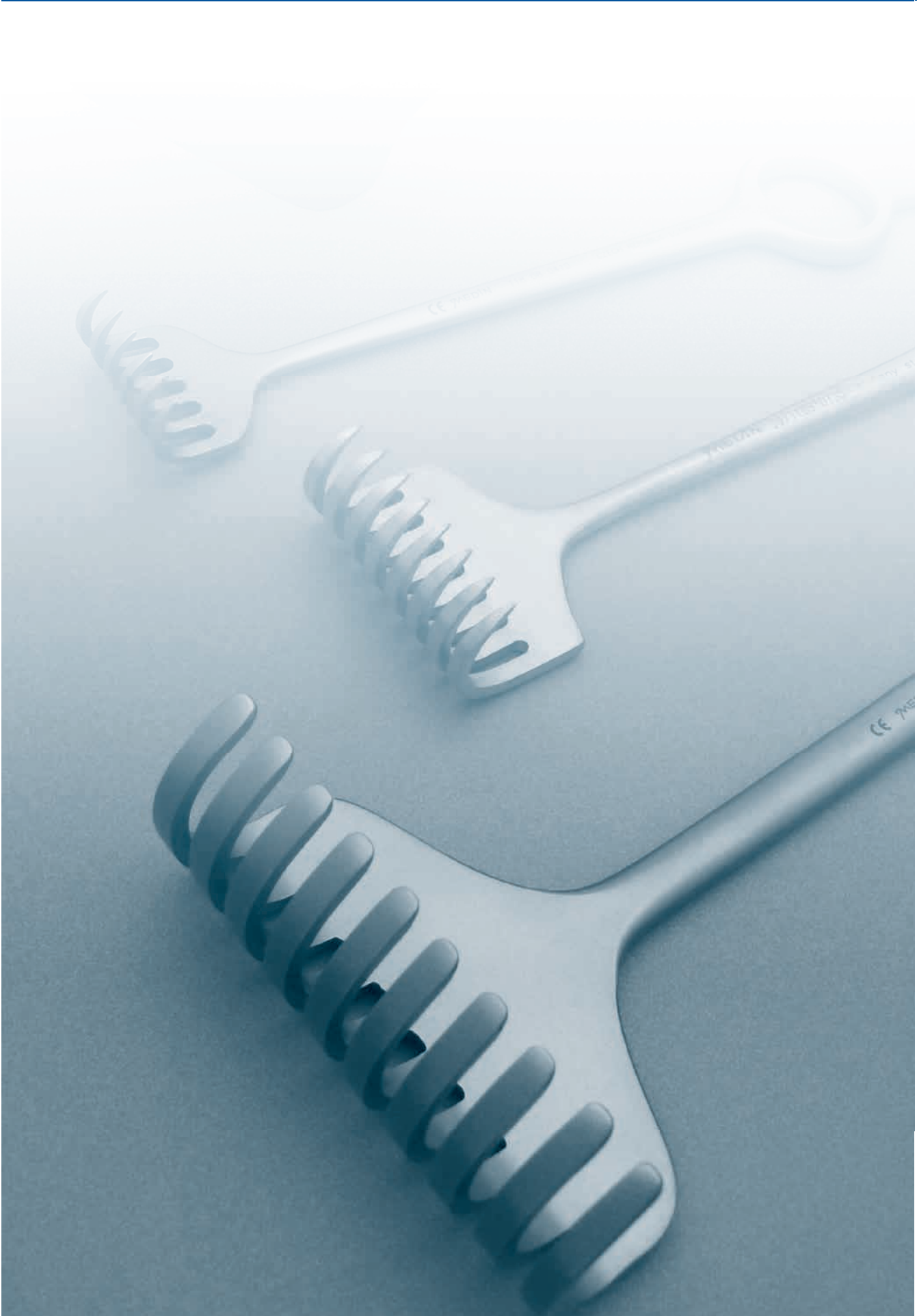



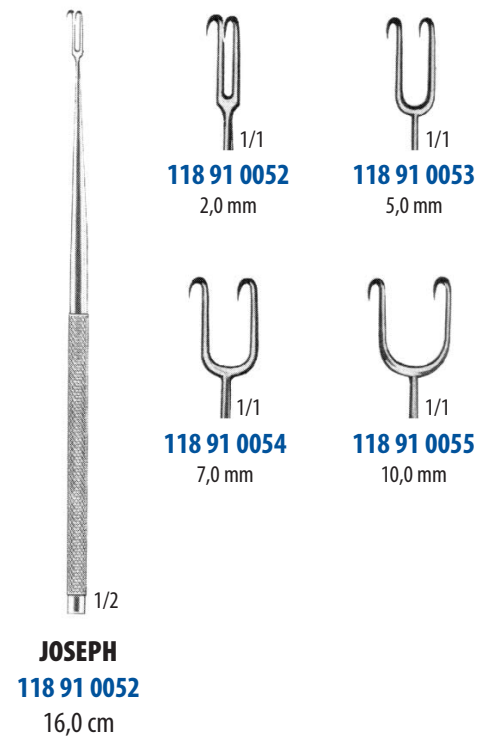
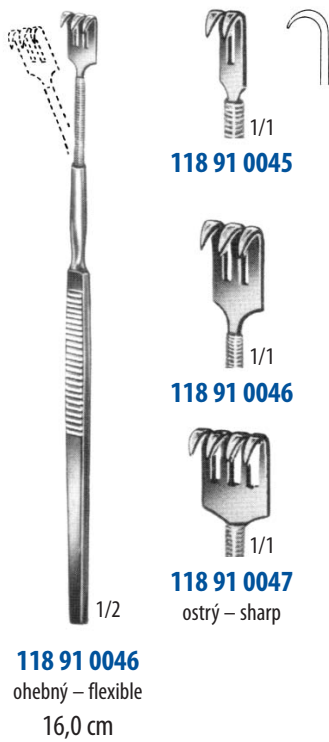
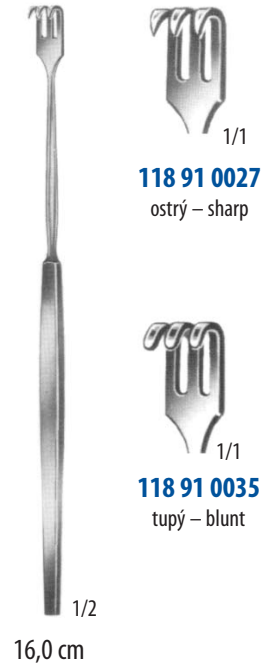

HÁKY JEMNÉ
DELICATE HOOKS



CUSHING
28,0 cm



118 91 0015
Fig. 1



118 91 0016
Fig. 2



CUSHING
19,0 cm



118 91 0017
Fig. 1



118 91 0018
Fig. 2



GRAEFE
16,0 cm



118 91 0013
ostrý – sharp



118 91 0014
tupý – blunt



16,0 cm



118 91 0008
Fig. 1



118 91 0009
Fig. 2



118 91 0010
Fig. 3



118 91 0011
Fig. 4



DESMARRES
13,0 cm

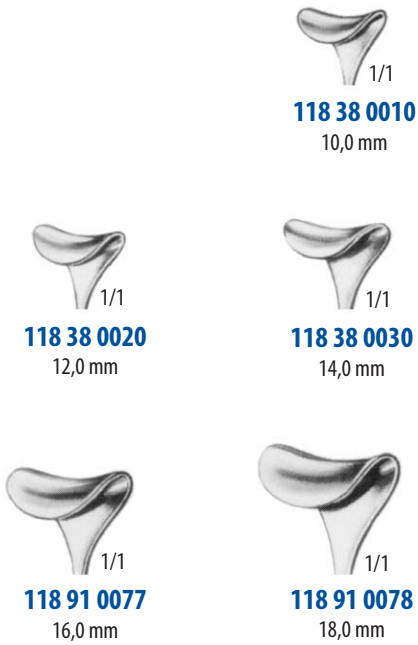

118 38 0020
12,0 mm

118 38 0010
10,0 mm

118 38 0030
14,0 mm

118 91 0077
16,0 mm

118 91 0078
18,0 mm



MINI-LANGENBECK
16,0 cm



118 91 0069

118 91 0070

118 91 0071

118 91 0072



CUSHING
20,0 cm

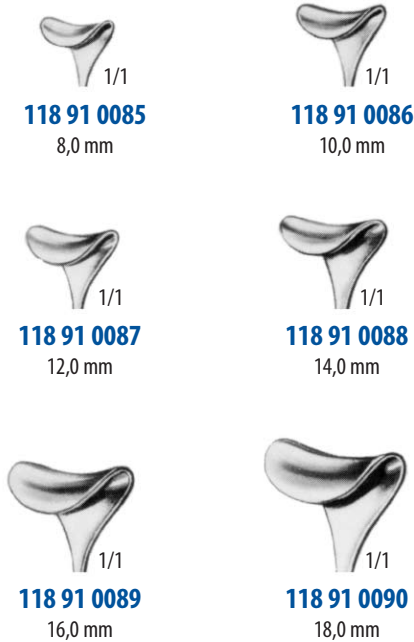

118 91 0085
8,0 mm

118 91 0086
10,0 mm

118 91 0087
12,0 mm

118 91 0088
14,0 mm

118 91 0089
16,0 mm

118 91 0090
18,0 mm



CUSHING
24,0 cm



118 91 0091
8,0 mm

118 91 0092
10,0 mm

118 91 0093
12,0 mm

118 91 0094
14,0 mm

118 91 0095
16,0 mm

118 91 0096
18,0 mm

HÁKY JEMNÉ, HÁKY OČNÍ
DELICATE HOOKS, EYE HOOKS

GRAEFE
118 38 0050
 ostrý – sharp
 13,0 cm

GRAEFE
118 38 0060
 tupý – blunt
 14,0 cm

HÁČEK NA ČOČKOVÉ POUZDRO
CAPSULE HOOK
118 38 0090
 14,0 cm

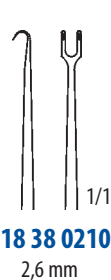
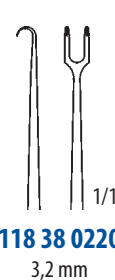
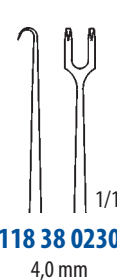
118 38 0210
 13,5 cm

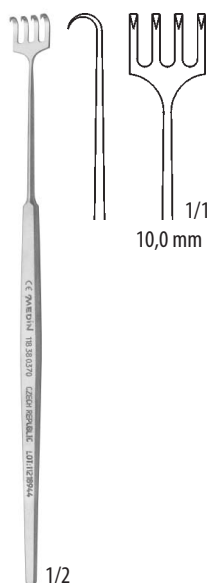
118 38 0210
 2,6 mm

118 38 0220
 3,2 mm

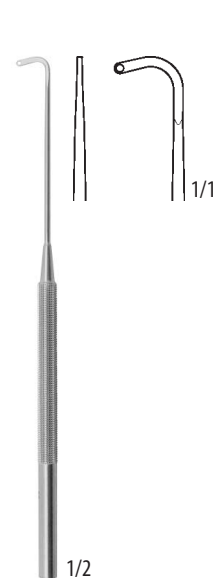
118 38 0230
 4,0 mm

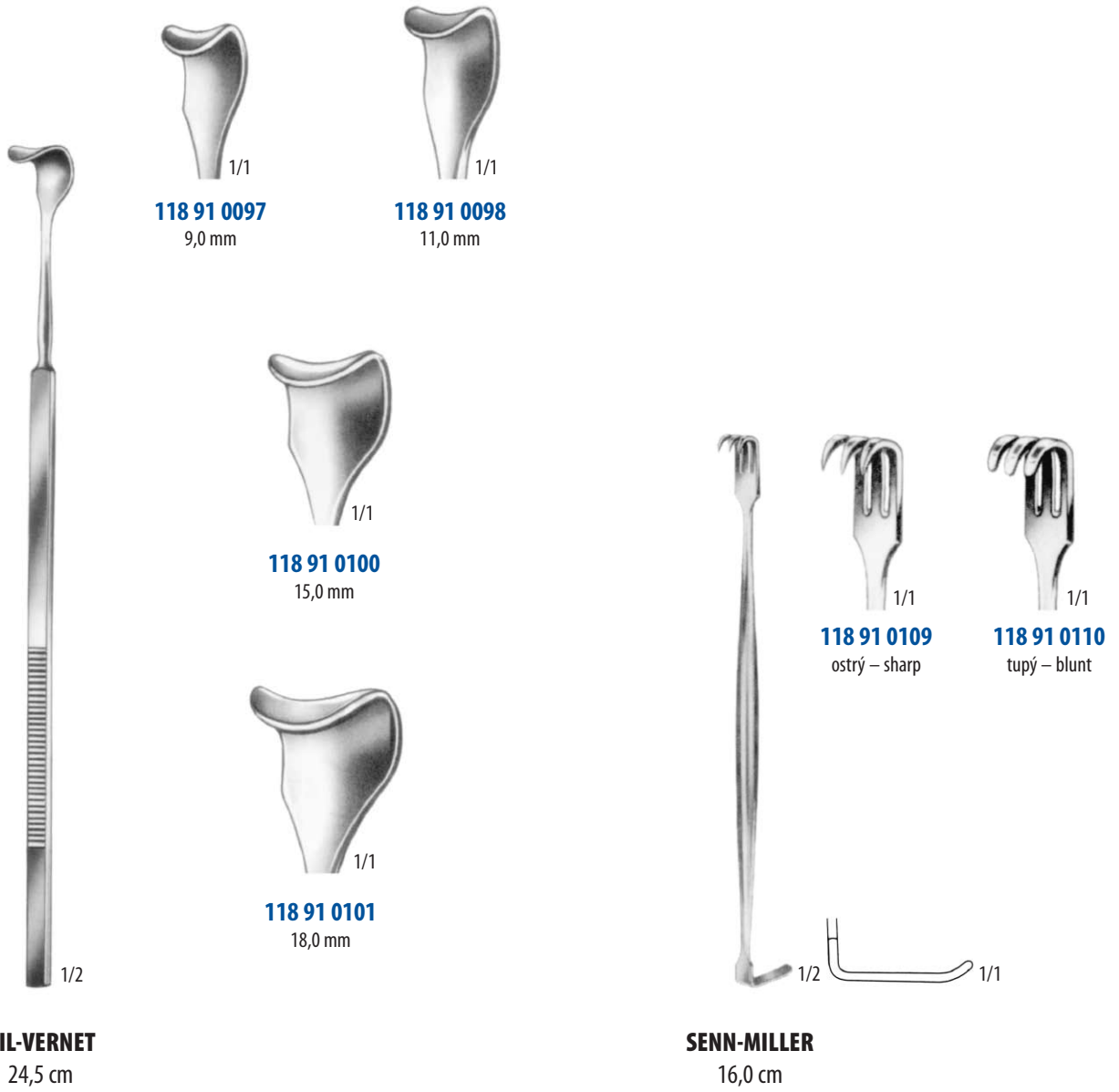
118 38 0360
 14,5 cm

118 38 0370
 15,0 cm

GRAEFE
118 38 0420
 14,5 cm

JAEGER
118 38 0460
 14,5 cm

118 38 0500
 14,0 cm



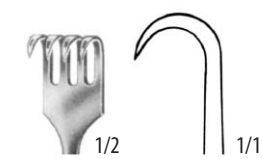

118 08 0310
Fig. 1

118 08 0350



118 08 0390

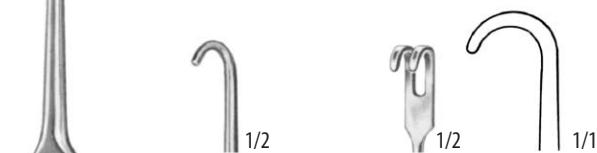

118 08 0330
Fig. 2

118 08 0360

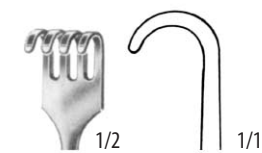

118 08 0400



1/2

VOLKMANN
21,5 cm



1/2

VOLKMANN
22,4 cm

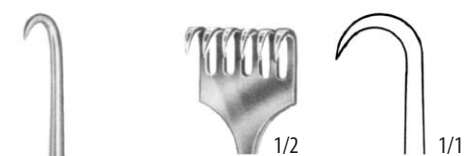

1/2

1/1

118 08 0410



1/2

1/1

118 08 0420

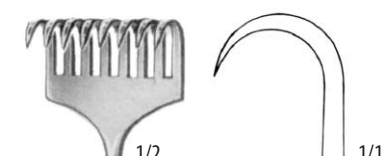

1/2

1/1

118 91 0135

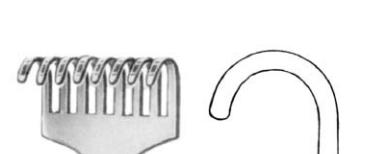

1/2

1/1

118 91 0147



1/2

VOLKMANN
22,0 cm



1/2

KOCHER
22,0 cm



1/2

VOLKMANN
21,5 cm

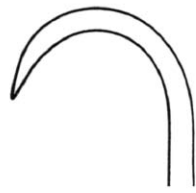

1/1

118 08 0320

Fig. 3



1/1

118 08 0340

Fig. 4



1/2

VOLKMANN
26,0 cm



1/1

118 08 0430

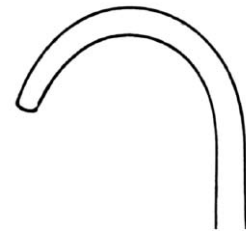

1/1

118 08 0440



1/2

KOERTE
24,0 cm

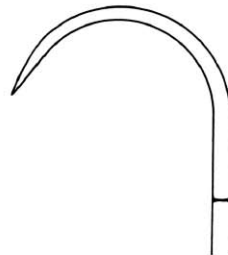

1/1

118 91 0152

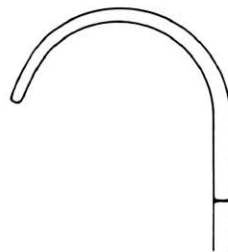

1/1

118 91 0153



ISRAEL

1/2



1/1

1/2

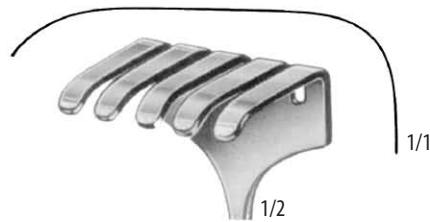
118 08 053024,0 cm
40 × 35 mm

1/1

1/2

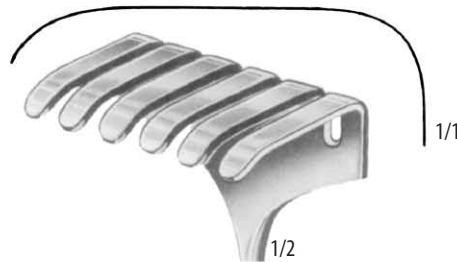
118 91 016025,0 cm
45 × 50 mm

1/1

1/2

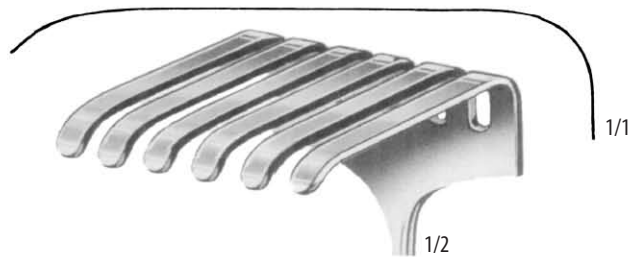
118 08 054026,0 cm
45 × 68 mm

1/1

1/2

118 91 016225,0 cm
70 × 70 mm



LANGENBECK
21,0 cm

1/2

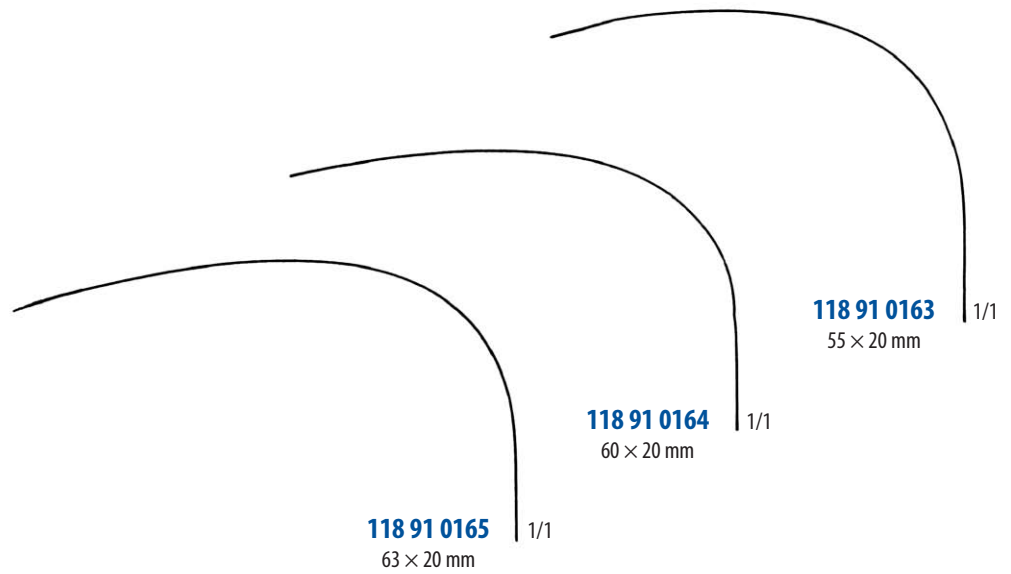

118 91 0165
63 × 20 mm

118 91 0164
60 × 20 mm

118 91 0163
55 × 20 mm

1/1

1/1

1/1



LANGENBECK

1/2

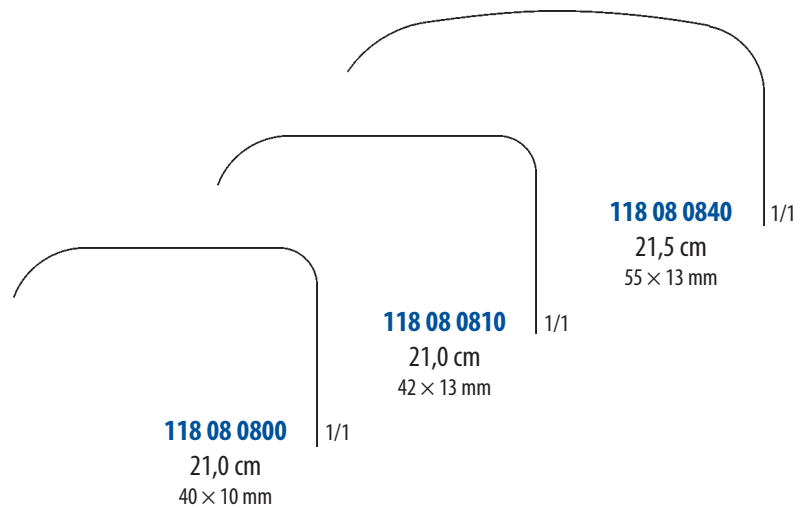

118 08 0800
21,0 cm
40 × 10 mm

118 08 0810
21,0 cm
42 × 13 mm

118 08 0840
21,5 cm
55 × 13 mm

1/1

1/1

1/1

HÁKY NA RÁNY
RETRACTORS

KOCHER
23,0 cm

1/2



1/1

118 08 1050
40 × 35 mm

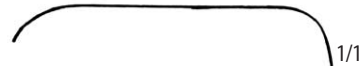

1/1

118 91 0185
40 × 18 mm

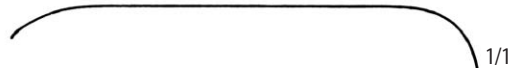

1/1

118 91 0186
60 × 20 mm

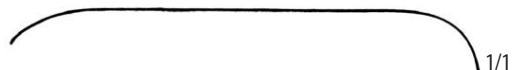

1/1

118 91 0187
60 × 25 mm



1/1

118 91 0188
75 × 30 mm

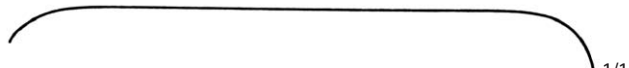

1/1

118 08 1060
70 × 35 mm

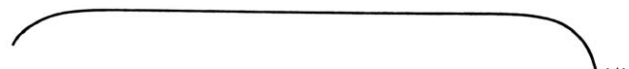

1/1

118 91 0189
75 × 40 mm



1/1

118 08 1070
100 × 40 mm

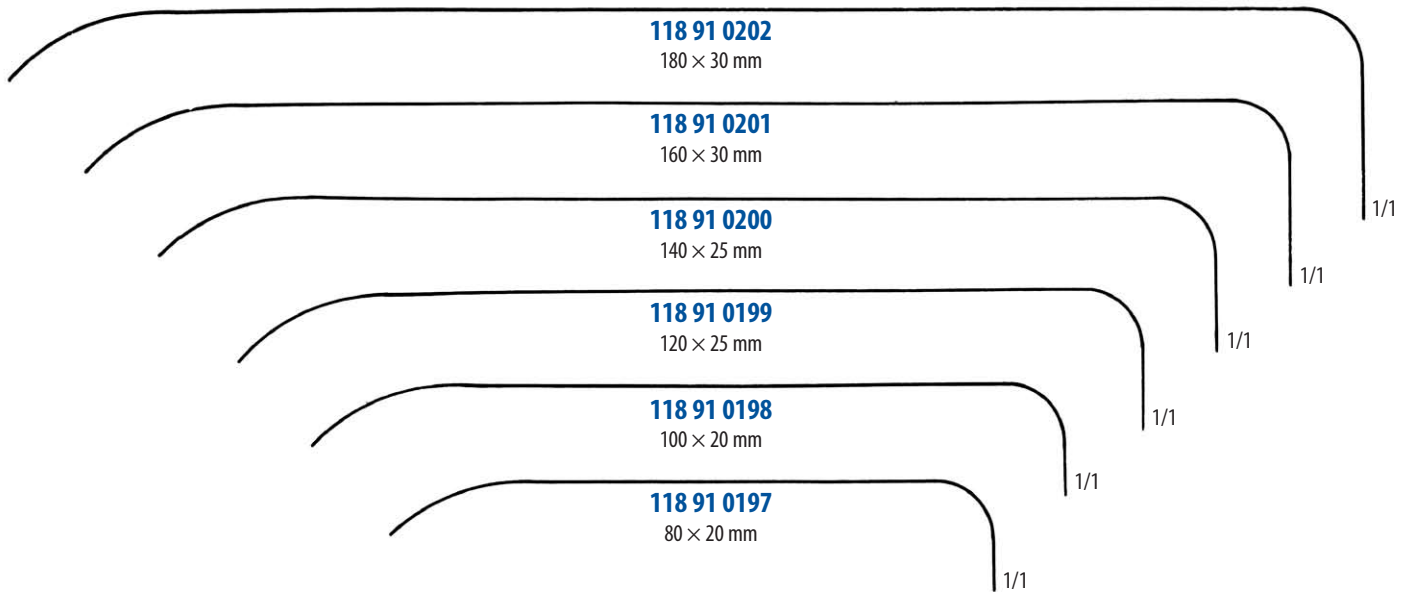

BRUNNER
25,0 cm

HÁKY NA RÁNY
RETRACTORS

MIDDELDORPF

1/2
14 × 17 mm
118 91 0208
21,5 cm1/2
20 × 22 mm
118 91 0209
22,0 cm1/2
14 × 12 mm
118 08 0650
22,0 cm1/2
21 × 21 mm
118 08 0660
22,0 cm1/2
26 × 30 mm
118 91 0210
23,5 cm

MIDDELDORPF

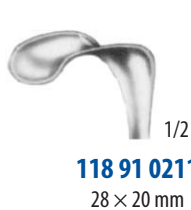
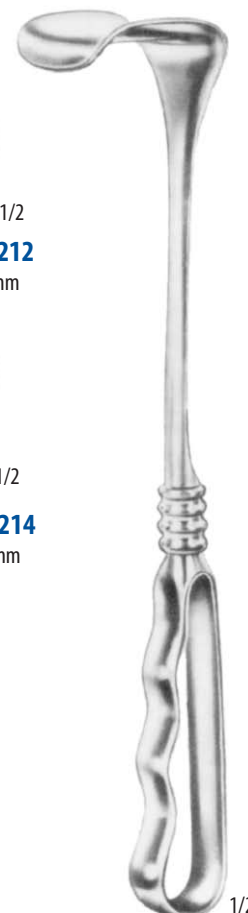
1/2
32 × 31 mm
118 08 0670
23,5 cm1/2
62 × 50 mm
118 08 0680
28,0 cm1/2
118 91 0211
28 × 20 mm1/2
118 91 0212
36 × 28 mm1/2
118 91 0213
44 × 38 mm1/2
118 91 0214
52 × 22 mm1/2
118 91 0215
65 × 50 mmRICHARDSON (KELLY)
24,0 mm



RICHARDSON-EASTMAN
118 91 0216 – Fig.1+2

Fig.1

118 91 0217

26,0 cm

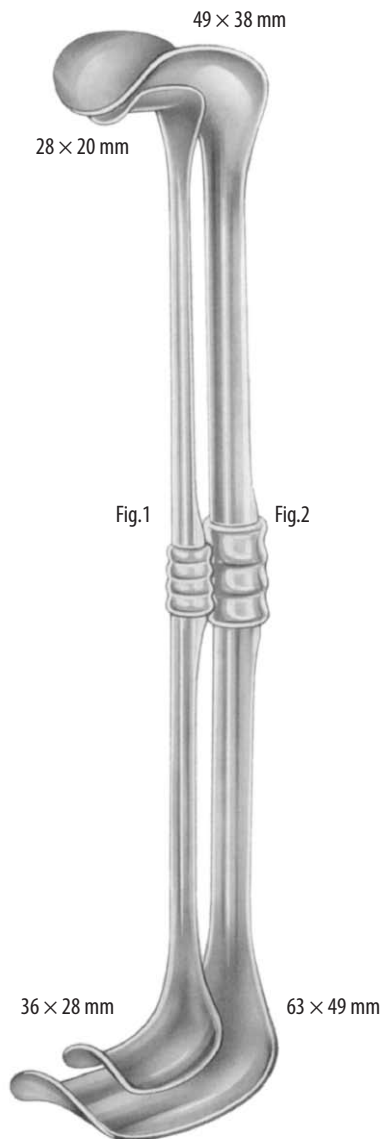
Fig.2

118 91 0218

28,0 cm

CALDWELL-LUC
118 08 0780

23,0 cm

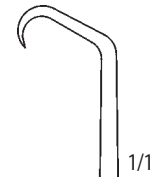
118 08 0760

12 x 13 mm

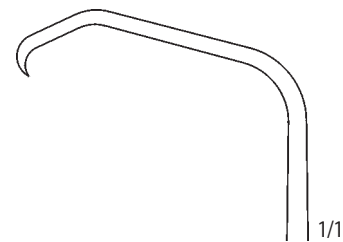
118 08 0770

37 x 13 mm

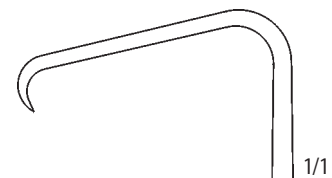
118 08 0780

35 x 13 mm

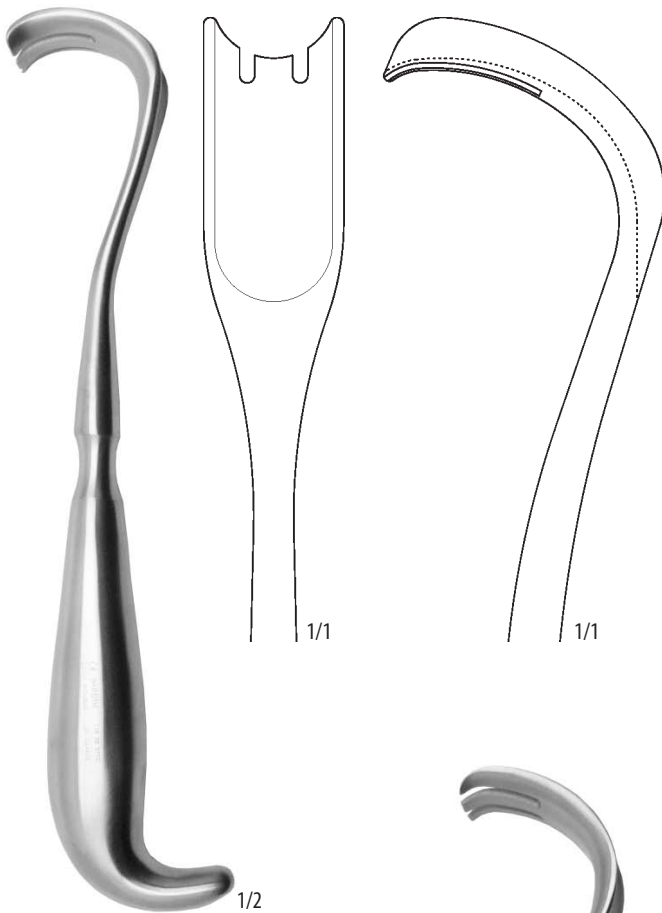

SEMB
118 08 0710
23,8 cm

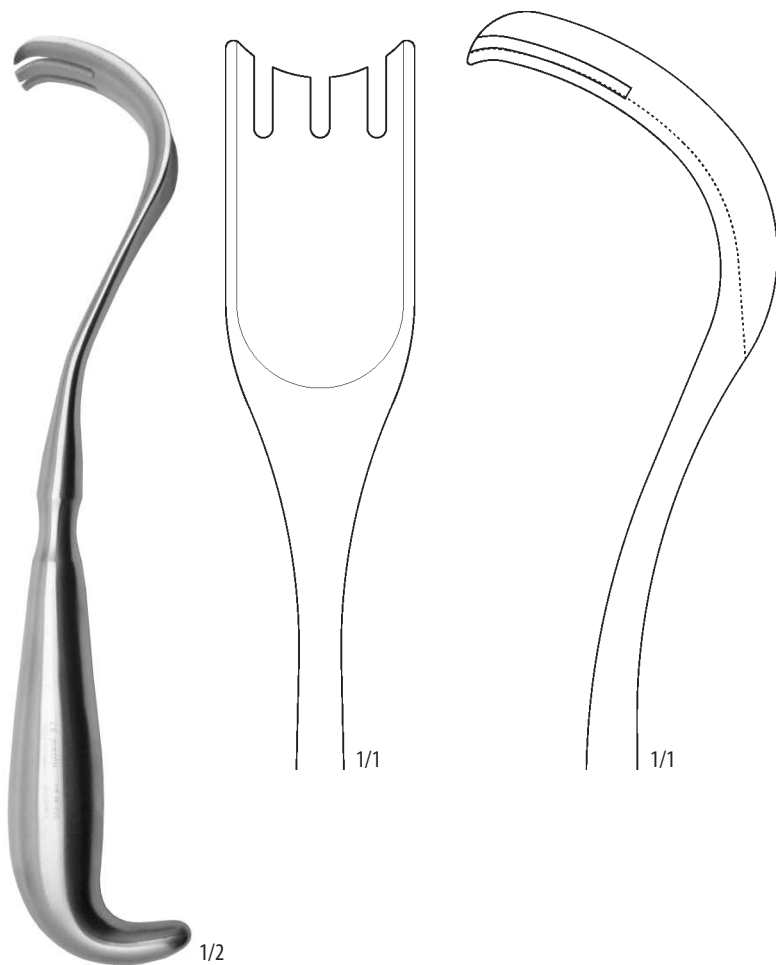

SEMB
118 08 0720
24,6 cm

118 08 1080 1/1
120 × 30 mm
24,0 cm

118 08 1090 1/1
140 × 50 mm
24,5 cm



FRITSCH
118 08 1120
40 × 35 mm
25,5 cm



FRITSCH
118 08 1130
50 × 80 mm
27,0 cm

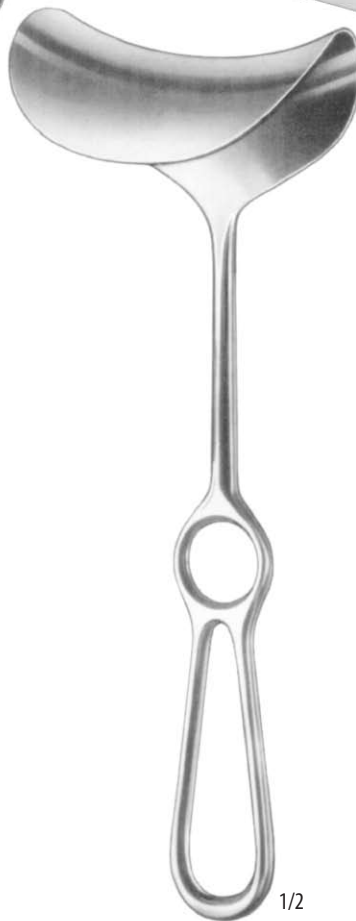

FRITSCH
24,0 cm
118 91 0225 – 45 × 40 mm
118 91 0226 – 45 × 50 mm
118 91 0227 – 45 × 60 mm
118 91 0228 – 45 × 75 mm
118 91 0229 – 65 × 85 mm



118 08 1090
140 × 50 mm
24,5 cm

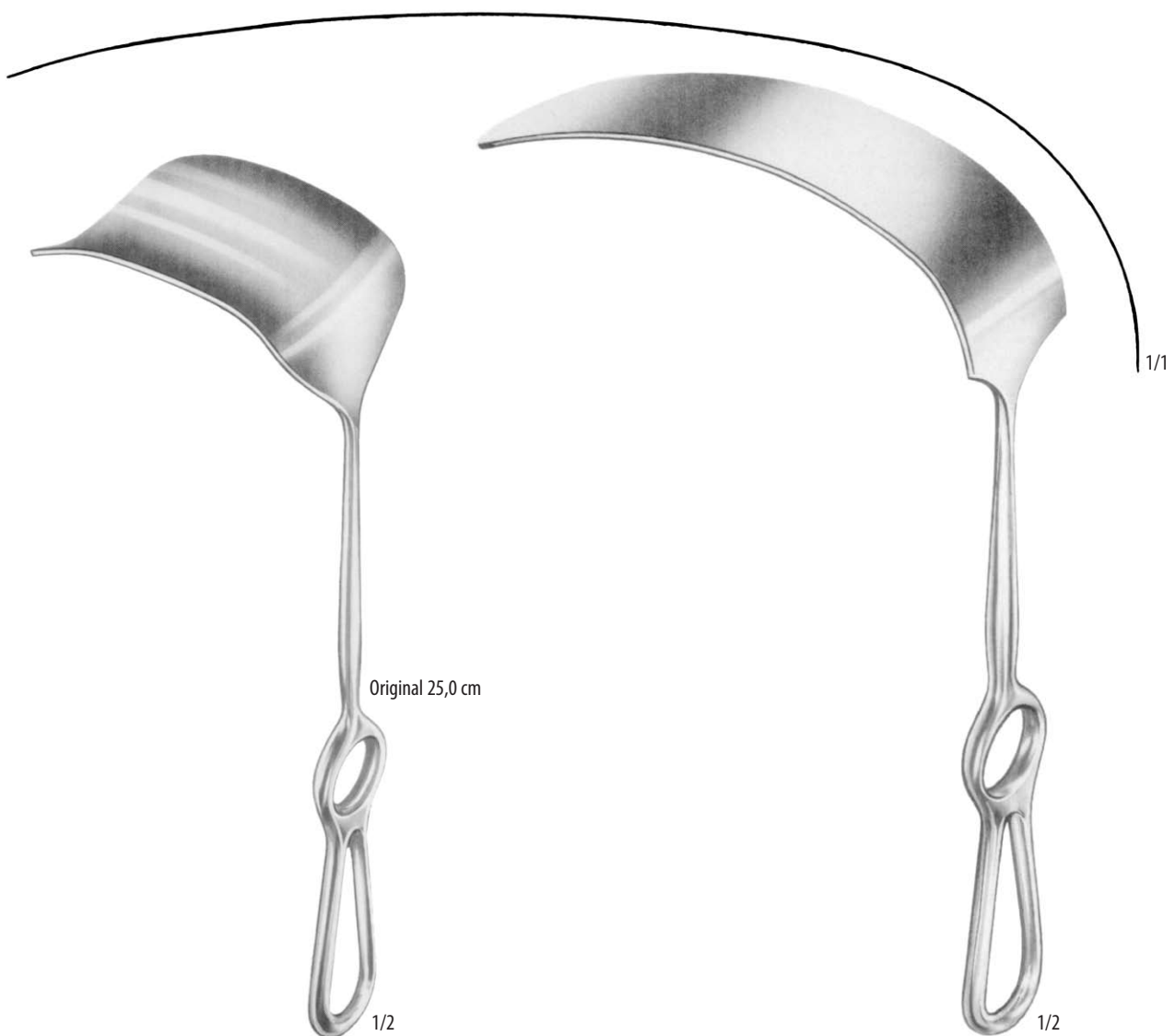

Original 25,0 cm

KOCHER

- 118 91 0230** – 22,0 cm – 70 × 25 mm
- 118 08 0550** – 25,0 cm – 80 × 40 mm
- 118 08 0560** – 25,0 cm – 80 × 50 mm
- 118 91 0233** – 25,0 cm – 80 × 60 mm

KELLY

27,0 cm

- 118 91 0249** – 160 × 38 mm
- 118 91 0250** – 160 × 57 mm
- 118 91 0251** – 190 × 38 mm
- 118 91 0252** – 190 × 57 mm

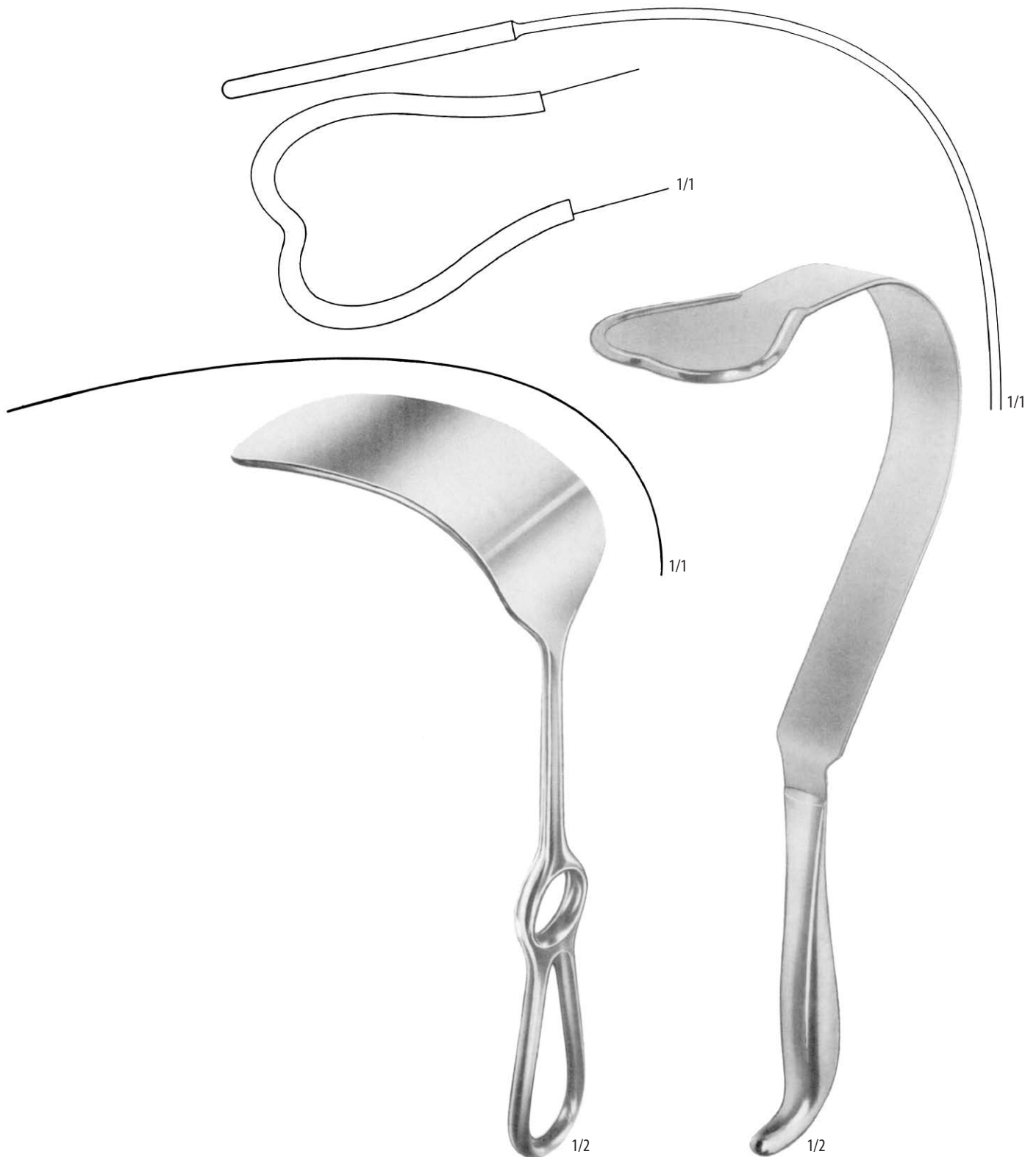

MIKULICZ

26,0 cm

118 91 0246 – 85 × 35 mm

118 08 1100 – 115 × 30 mm

118 91 0247 – 120 × 50 mm

118 08 1110 – 135 × 50 mm

118 91 0248 – 155 × 50 mm

HARRINGTON

32,0 cm

118 91 0242 – 127 × 40 mm

118 91 0243 – 127 × 62 mm

118 91 0244 – 175 × 64 mm





DEAVER
118 91 0259
30,0 cm



DEAVER
118 91 0260
30,0 cm

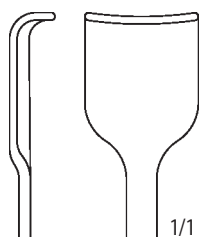
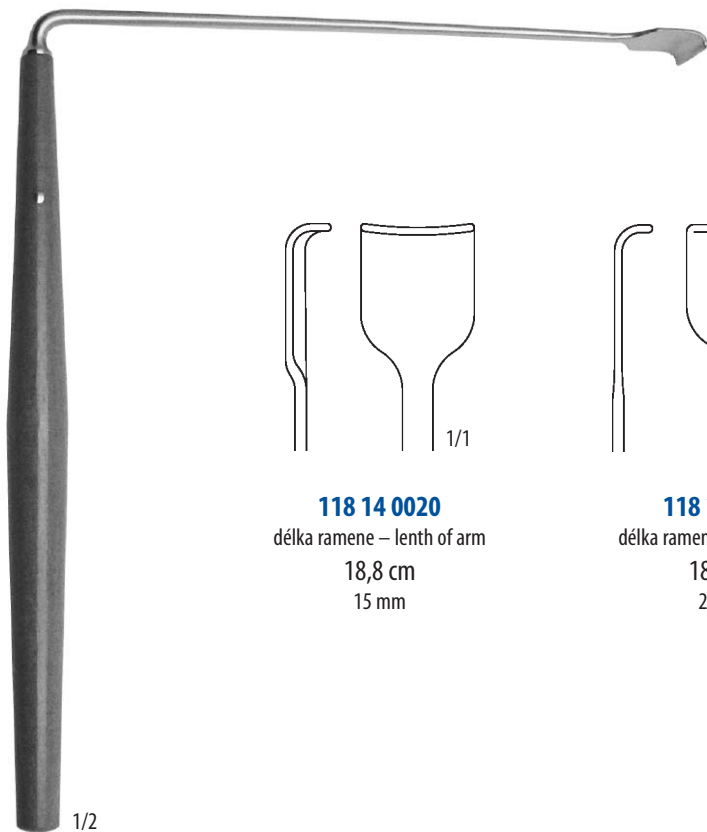

DEAVER
118 91 0261
30,0 cm

HÁKY NA PLÍCNICI
RETRACTORS PULMONALIS
**118 14 0020**

délka ramene – lenth of arm

18,8 cm

15 mm

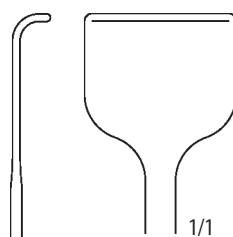
**118 14 0030**

délka ramene – lenth of arm

18,8 cm

20 mm

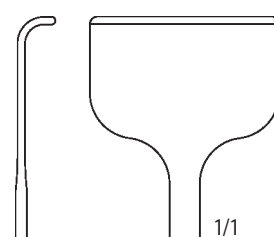
**118 14 0040**

délka ramene – lenth of arm

19,2 cm

25 mm

118 14 0030

22,0 cm

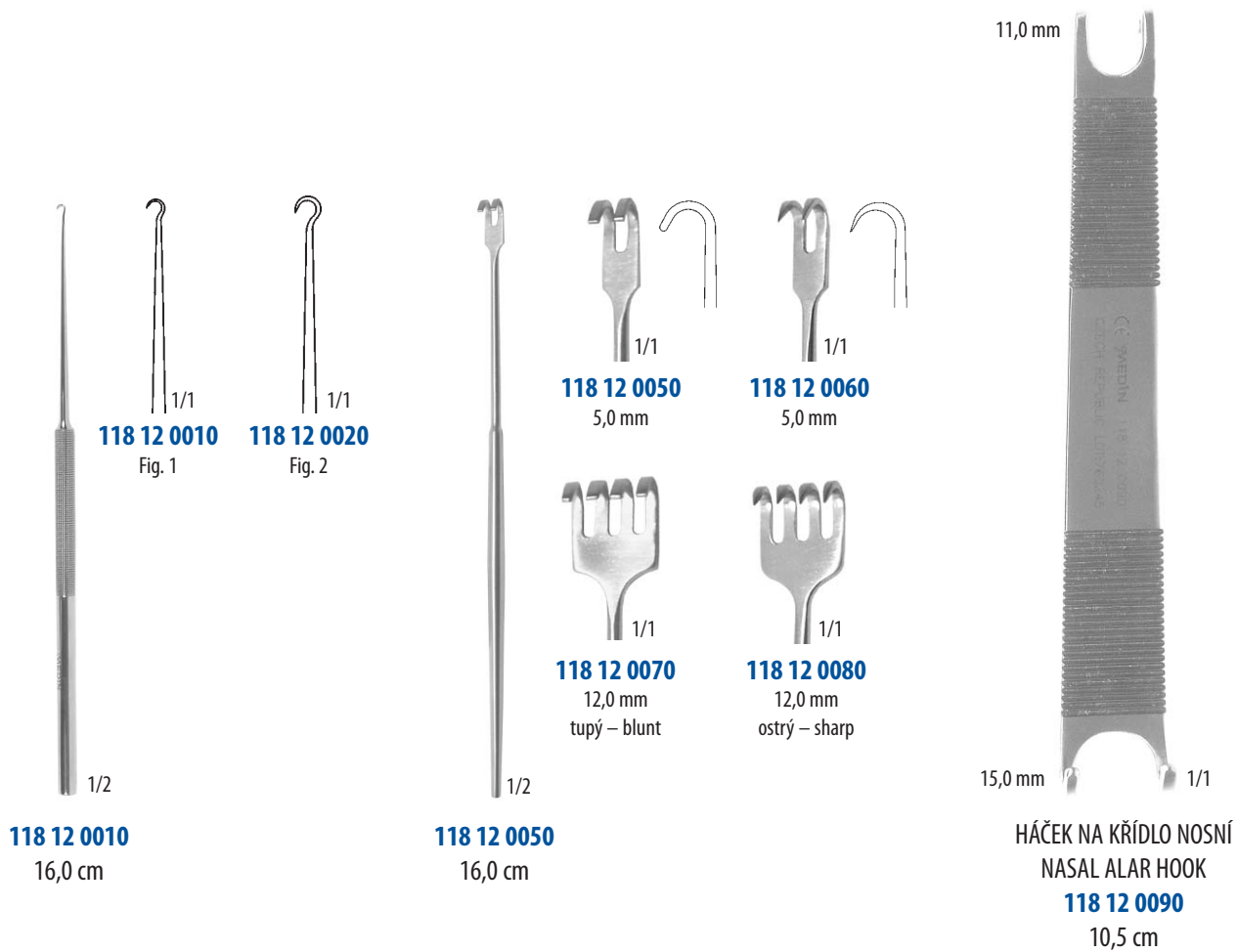
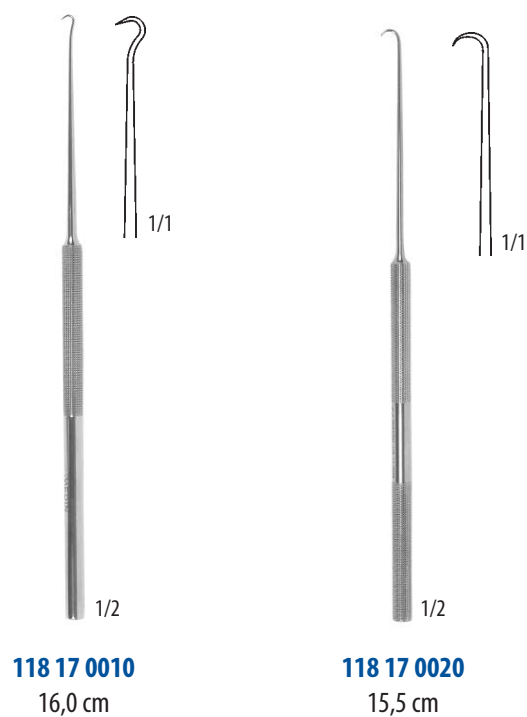

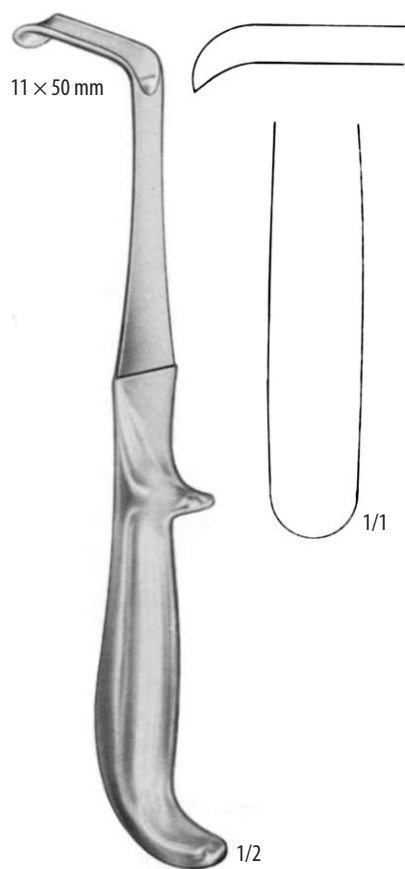
 HÁČKY PRO NEUROCHIRURGII
NEUROSURGICAL HOOKS

HÁKY NA PROSTATU
PROSTATIC RETRACTORS

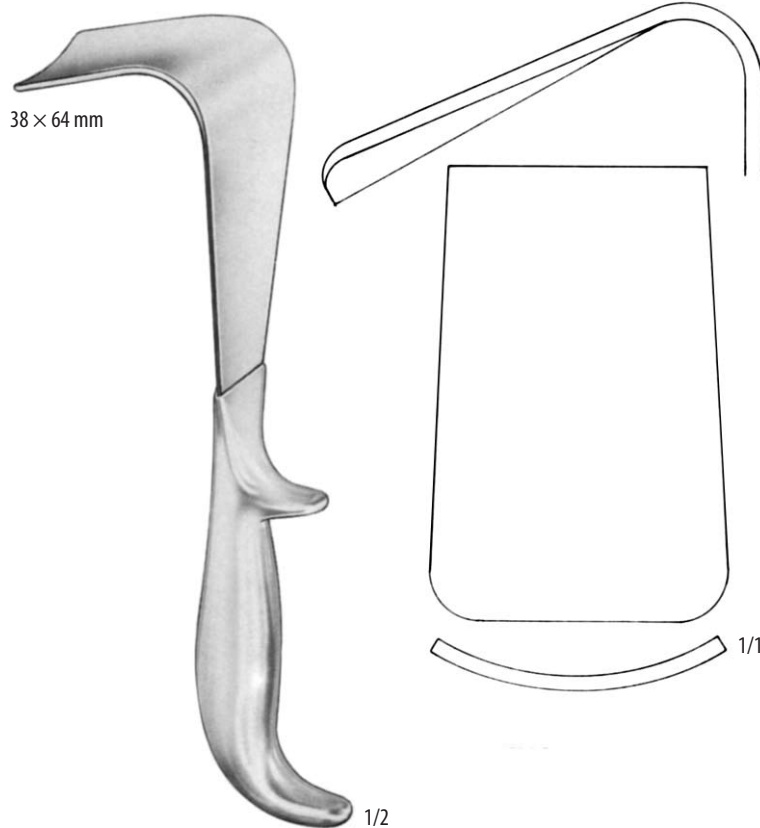
YOUNG
118 91 0409
 21,0 cm

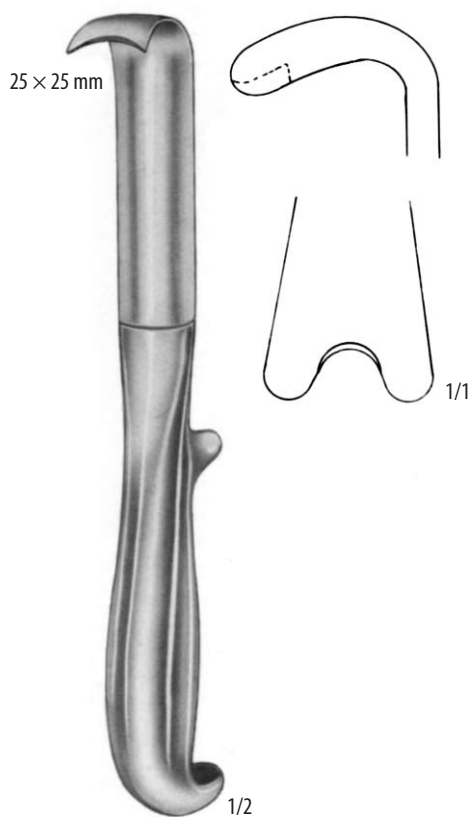

YOUNG
118 91 0410
 22,0 cm



YOUNG
118 91 0411
 21,0 cm

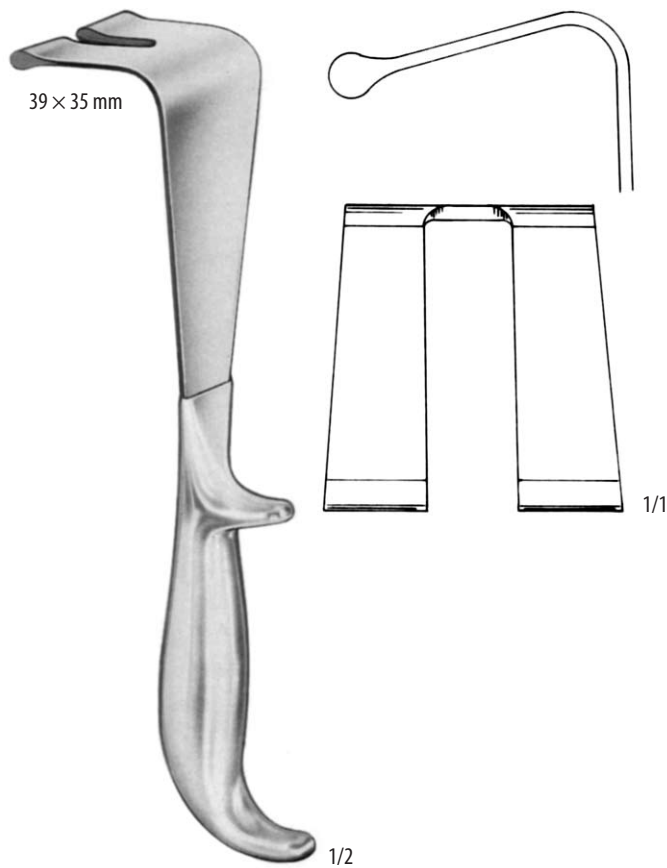

YOUNG
118 91 0412
22,0 cm



SMELLIE
HÁK DEKAPITAČNÍ A PORODNICKÝ
DECAPITATING HOOK
118 28 0010
32,0 cm



HARTMANN
118 29 0010
17,0 cm



BERTHOLD
118 29 0040
18,0 cm



SCHWARTZE
118 29 0060
17,0 cm

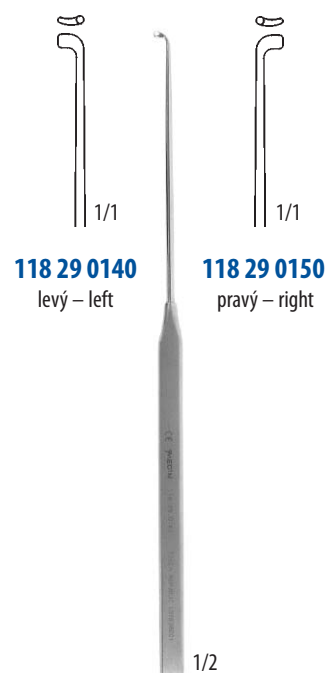

118 29 0140
levý – left

118 29 0150
pravý – right

LUDEWIG
17,0 cm



TROELTSCH
118 29 0070
20,5 cm
27 mm



HÁK NA CHOANÁLNÍ POLYPY
CHOANAL HOOK
118 30 0120
22,5 cm



118 34 0020
23,5 cm

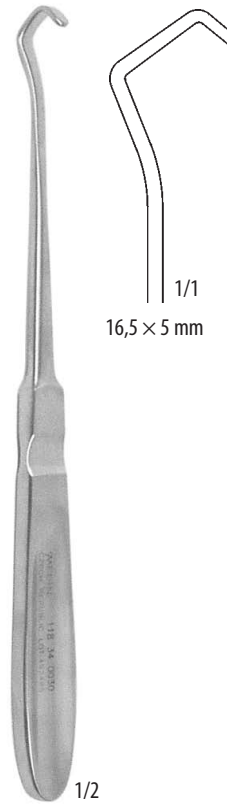

118 34 0030
21,0 cm

HÁK NA MENISKUS
MENISCUS HOOK

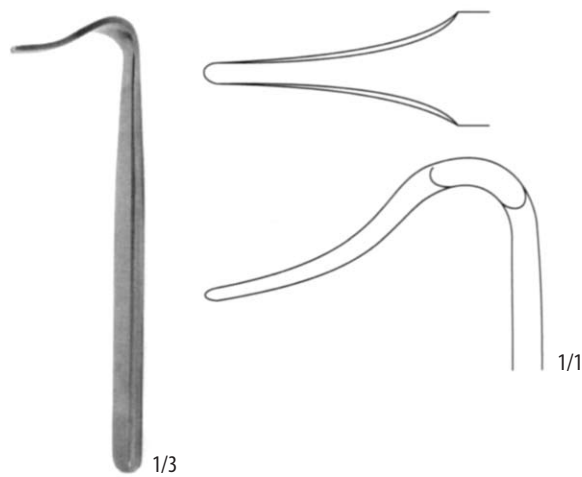

118 91 0396
17,5 cm

HÁKY RESEKČNÍ
RESECTION HOOKS

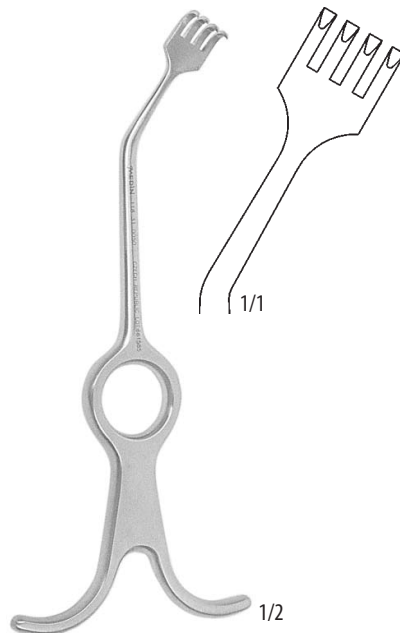

118 31 0040
 rovný – straight
 16,4 cm

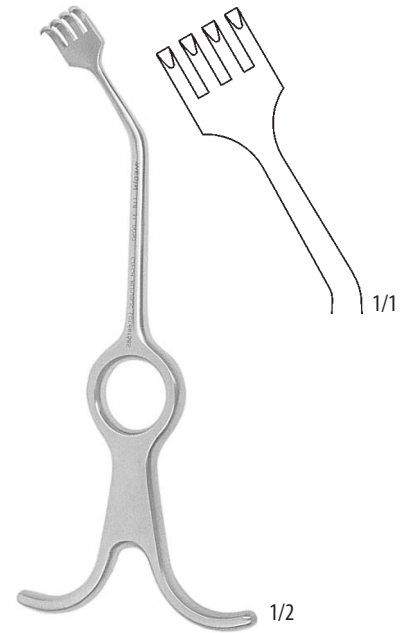

118 31 0050
 pravý – right
 16,2 cm

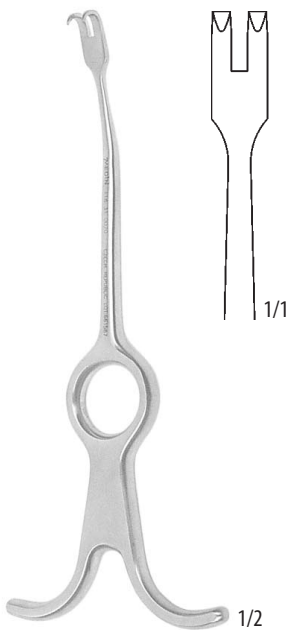

118 31 0060
 levý – left
 16,2 cm



118 31 0070
 rovný – straight
 16,4 cm

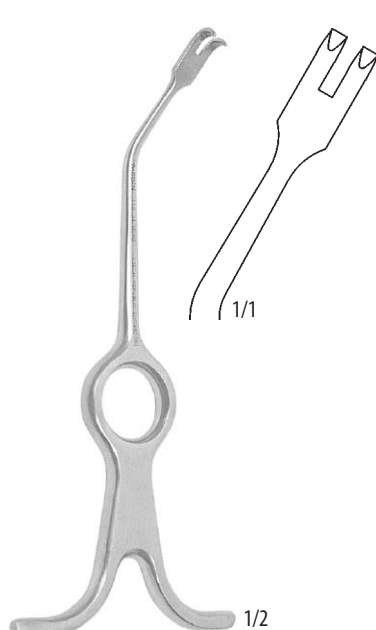

118 31 0080
 pravý – right
 16,1 cm

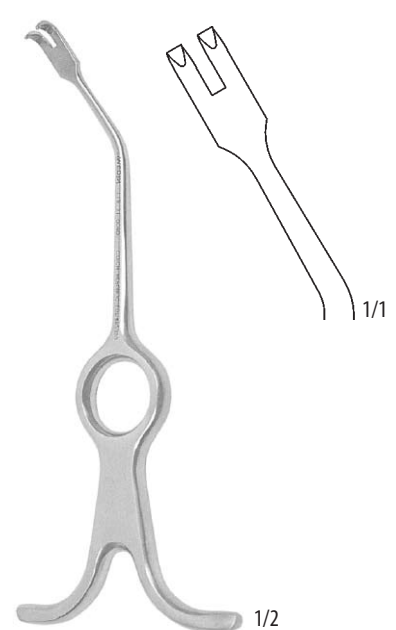

118 31 0090
 levý – left
 16,1 cm

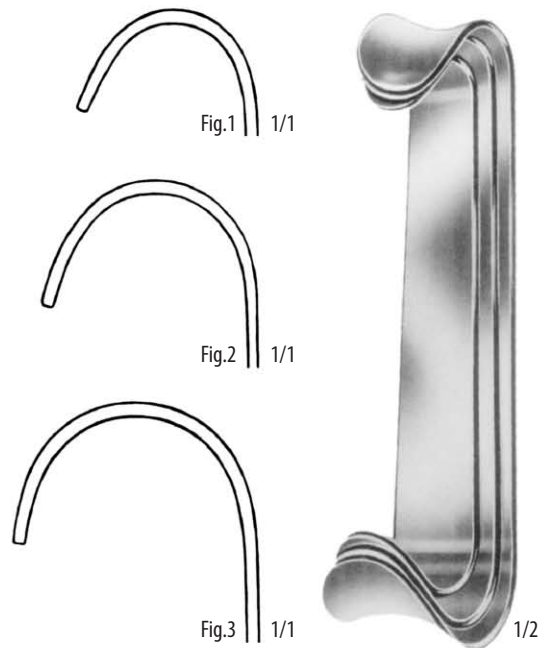
ROUX

118 91 0294 – Fig. 1-3
 sada – set

16,5 cm

118 91 0295 – Fig. 1

118 91 0296 – Fig. 2

118 91 0297 – Fig. 3

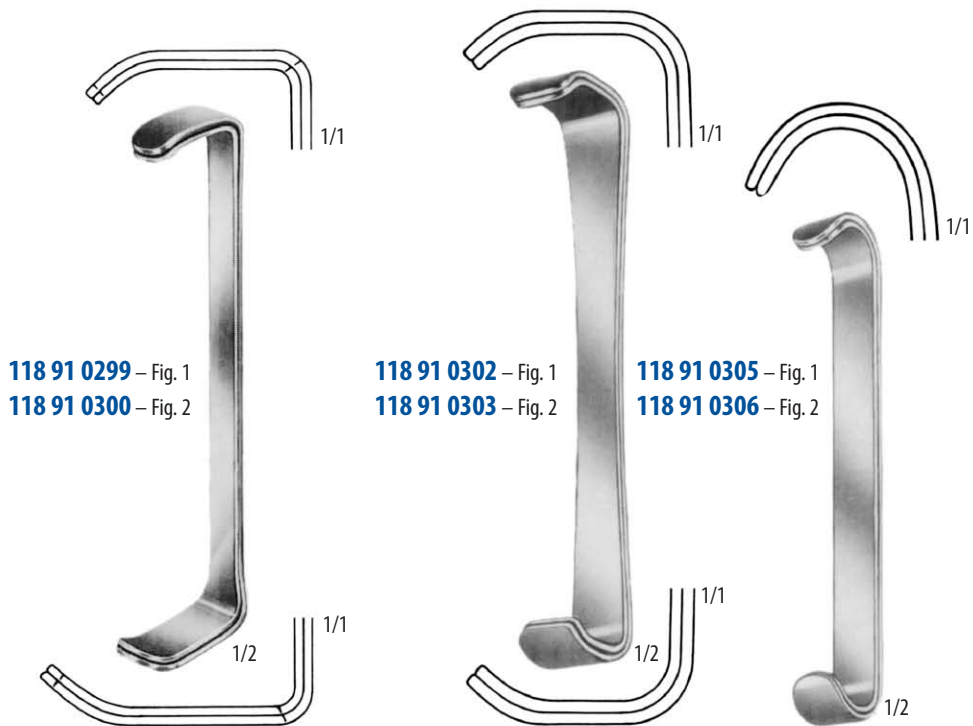

118 91 0299 – Fig. 1

118 91 0300 – Fig. 2

118 91 0302 – Fig. 1

118 91 0303 – Fig. 2

118 91 0305 – Fig. 1

118 91 0306 – Fig. 2

FARABEUF

118 91 0298 – Fig. 1+2

12,0 cm

FARABEUF

118 91 0301 – Fig. 1+2

15,0 cm

PARKER

118 91 0304 – Fig. 1+2

13,5 cm

118 91 0308 – Fig. 1
118 91 0309 – Fig. 2



118 91 0311 – Fig. 1
118 91 0312 – Fig. 2



PARKER
118 91 0307 – Fig. 1+2
18,0 cm

30 × 31 mm

MATHIEU
118 91 0310 – Fig. 1+2
20,0 cm

118 91 0314 – Fig. 1
118 91 0315 – Fig. 2



PARKER-LANGENBECK
118 91 0313 – Fig. 1+2
21,0 cm



GOELET
118 91 0316
19,0 cm

37 × 40 mm



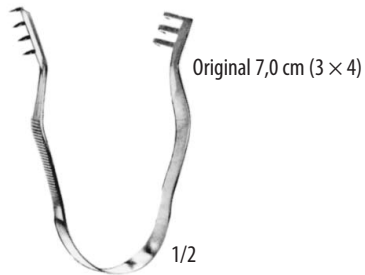

FINSEN

ostrý – sharp

119 91 0001 – 5,0 cm (2 × 3)

119 91 0002 – 7,0 cm (3 × 4)

tupý – blunt

119 91 0003 – 5,0 cm (2 × 3)

119 91 0004 – 7,0 cm (3 × 4)

ostrý – sharp

119 91 0005 – 10,0 cm (4 × 4)

tupý – blunt

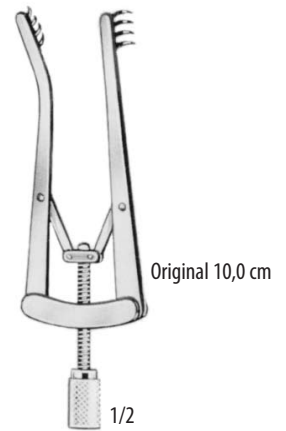
119 91 0006 – 10,0 cm (4 × 4)

ALM

ostrý – sharp

119 91 0007 – 7,0 cm (4 × 4)

119 91 0008 – 10,0 cm (4 × 4)

tupý – blunt

119 91 0009 – 7,0 cm (4 × 4)

119 91 0010 – 10,0 cm (4 × 4)

JANSEN

ostrý – sharp

119 91 0013 – 10,0 cm (4 × 4)

tupý – blunt

119 91 0014 – 10,0 cm (4 × 4)

MÜLLER
119 38 0400

7,0 cm

ROZVĚRAČE VÍČEK
LIDS RETRACTORS

WEBER
pravý – right
119 38 0050
8,0 cm



WEBER
levý – left
119 38 0060
8,0 cm



119 10 0100
4,3 cm
kojenecký – infantile

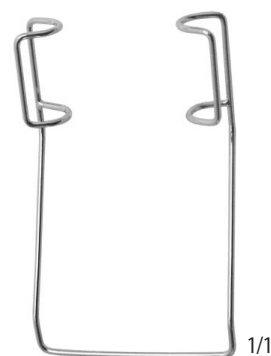

119 38 0070
4,6 cm
mikro – micro

ROZVĚRAČE, ROZVĚRAČE RAN
RETRACTORS, SELF-RETAINING RETRACTORS

ROSER-KÖNIG
119 07 0010
19,5 cm



HEISTER
119 07 0020
13,0 cm



119 08 0240
ostrý – sharp
18,3 cm
(4 × 5)

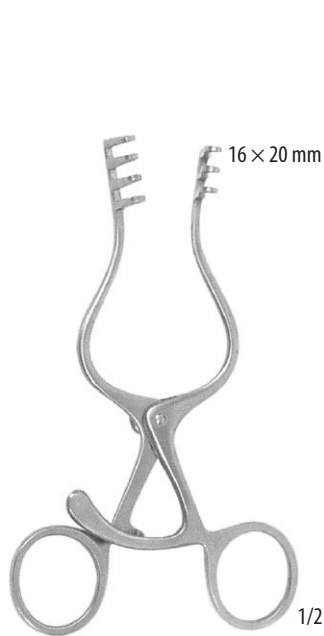

WEITLANER

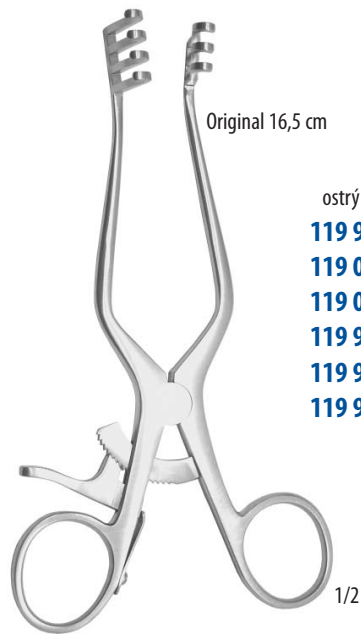
ostrý – sharp tupý – blunt
119 08 0100 – 13,0 cm – **119 08 0110**
 (3 × 4) (3 × 4)

WEITLANER

Original 16,5 cm

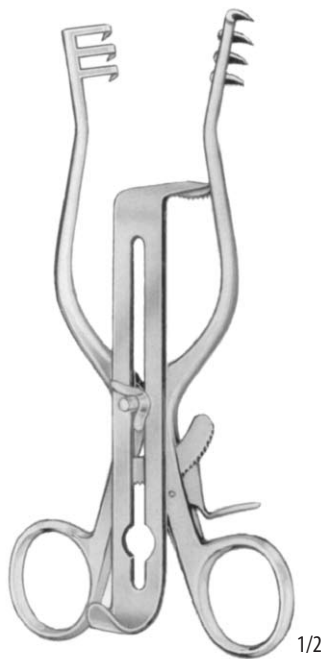
ostrý – sharp		tupý – blunt	
119 91 0020	– 10,5 cm –	119 91 0021	(2 × 3)
119 08 1040	– 13,5 cm –	119 08 1060	(3 × 4)
119 08 0680	– 16,5 cm –	119 08 0690	(3 × 4)
119 91 0026	– 20,0 cm –	119 91 0027	(3 × 4)
119 91 0028	– 25,0 cm –	119 91 0029	(3 × 4)
119 91 0030	– 26,0 cm –	119 91 0031	(5 × 6)

HENLEY

ostrý – sharp tupý – blunt
119 91 0032 – 16,5 cm – **119 91 0036**
 (3 × 4) (3 × 4)



119 91 0033
19 × 16 mm

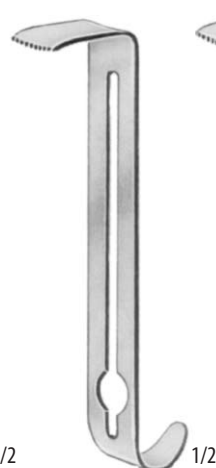

119 91 0034
25 × 16 mm

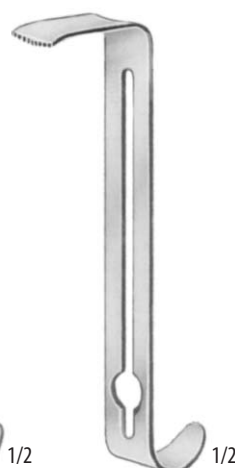

119 91 0035
32 × 16 mm

119 08 0870

30,0 cm
Fig. 1

ROZVĚRAČE RAN
SELF-RETAINING RETRACTORS**ADSON**

ostrý – sharp tupý – blunt
119 91 0052 – 20,0 cm – **119 91 0053**
 (4 × 4) (4 × 4)

**ANDERSON-ADSON**

ostrý – sharp tupý – blunt
119 91 0054 – 20,0 cm – **119 91 0055**
 (4 × 4) (4 × 4)



Original 16,0 cm

WULLSTEIN

ostrý – sharp tupý – blunt
119 91 0042 – 10,5 cm – **119 91 0045**
119 91 0043 – 13,0 cm – **119 91 0046**
119 91 0044 – 16,0 cm – **119 91 0047**
 (3 × 3) (3 × 3)

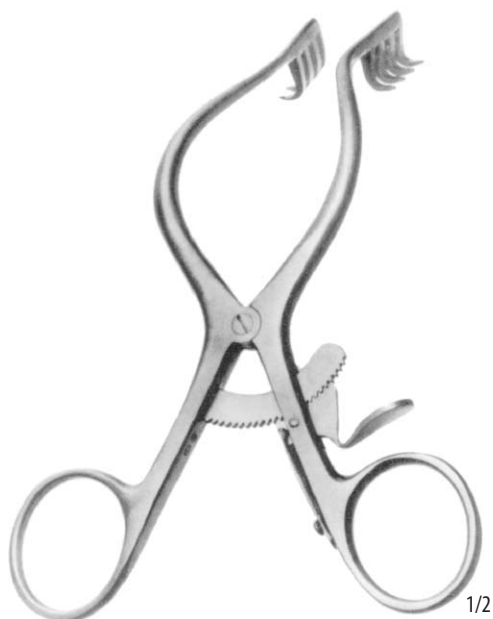
**MOLLISON**

ostrý – sharp tupý – blunt
119 91 0048 – 15,0 cm – **119 91 0049**
 (4 × 4) (4 × 4)

**MISKIMON**

ostrý – sharp tupý – blunt
119 91 0050 – 22,0 cm – **119 91 0051**
 (7 × 7) (7 × 7)



1/2

CONE

ostrý – sharp

tupý – blunt

119 91 0062 – 16,5 cm – **119 91 0066**
(3 × 4)

(3 × 4)

(3 × 4)

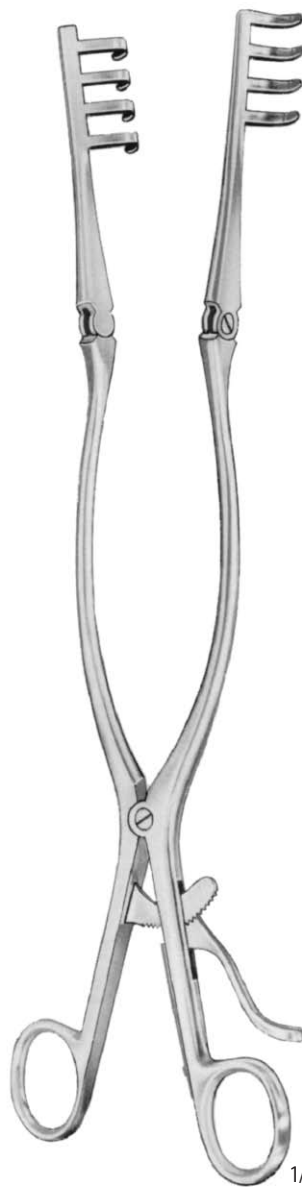

1/2

BECKMANN

ostrý – sharp

tupý – blunt

119 91 0069 – 31,0 cm – **119 91 0070**
(4 × 4)

(4 × 4)

(4 × 4)



1/2

BECKMANN-EATON

ostrý – sharp

tupý – blunt

119 91 0081 – 33,0 cm – **119 91 0082**
(7 × 7)

(7 × 7)

(7 × 7)

ROZVĚRAČE RAN
SELF-RETAINING RETRACTORS
**GELPI**

119 91 0085 – 9,0 cm
119 91 0086 – 11,0 cm
119 91 0087 – 14,0 cm
119 91 0088 – 19,0 cm

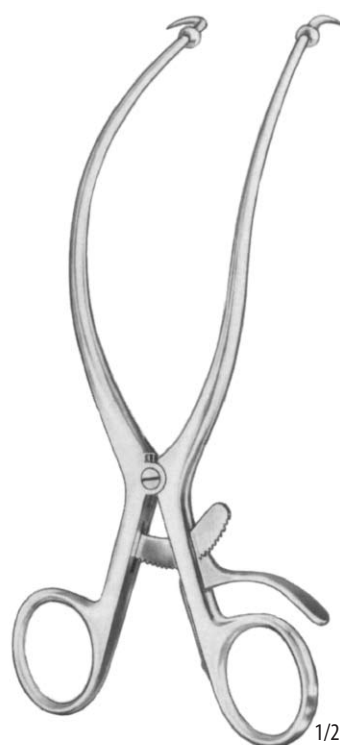
**GELPI**

119 91 0089
 19,0 cm

**DARLING**

119 91 0099
 18,0 cm
 Fig. 1

**MARKHAM-MEYERDING**

pravý – right

119 91 0094
 18,0 cm
 Fig. 1

**MARKHAM-MEYERDING**

levý – left

119 91 0095
 18,0 cm
 Fig. 2

**DARLING****119 91 0100**

18,0 cm
 Fig. 2

32 × 32 mm



RIGBY
119 08 0670
18,5 cm

Original 13,0 cm



PLESTER
pravý – right
119 91 0103 – 10,0 cm
119 91 0104 – 13,0 cm

Original 13,0 cm



PLESTER
levý – left
119 91 0105 – 10,0 cm
119 91 0106 – 13,0 cm



MAYO-ADAMS
119 91 0110
17,0 cm

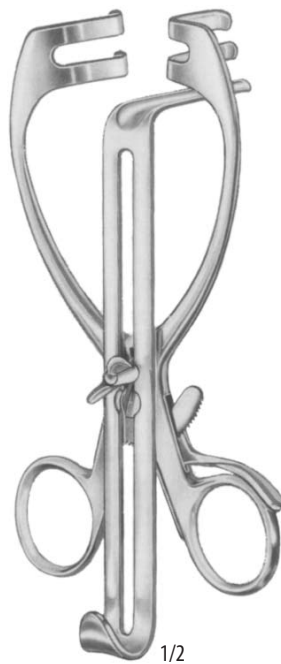

MAYO-ADAMS
119 91 0111
17,0 cm



119 08 1170
17,5 cm

ROZVĚRAČE RAN
SELF-RETAINING RETRACTORS

WALTON
pravý – right
119 08 0610
19,5 cm



WALTON
levý – left
119 08 0620
19,5 cm



ADSON
ostrý – sharp
119 08 0650
23,3 cm
(3 × 4)

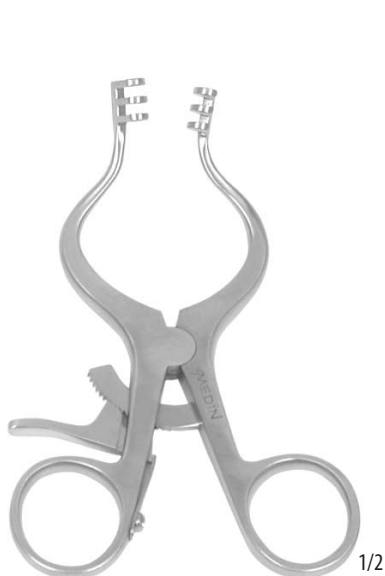

ostrý – sharp
119 08 1100 – 13,0 cm – **119 08 1110**
(2 × 2)
119 08 1080 – 13,0 cm – **119 08 1090**
(3 × 3)



tupý – blunt
119 08 1120
14,5 cm
(3 × 4)



ostrý – sharp
119 08 1140 – 13,5 cm – **119 08 1150**
(3 × 4)
tupý – blunt
(3 × 4)



CHANDLER
119 14 0020
komplet – complete
23,2 cm

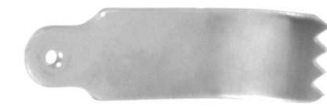

78 × 24 mm



64 × 24 mm



78 × 24 mm

1/2



64 × 24 mm

1/2

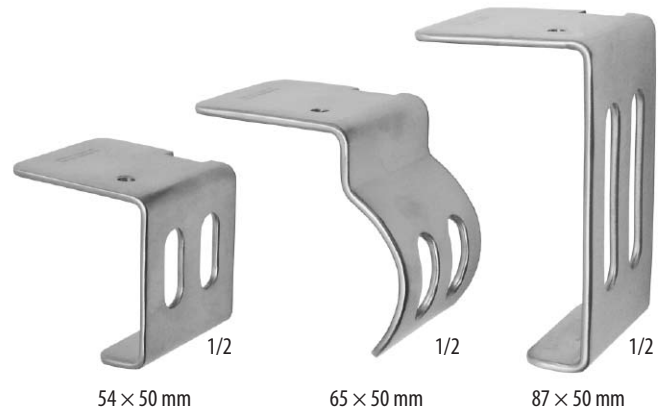

54 × 50 mm

65 × 50 mm

87 × 50 mm

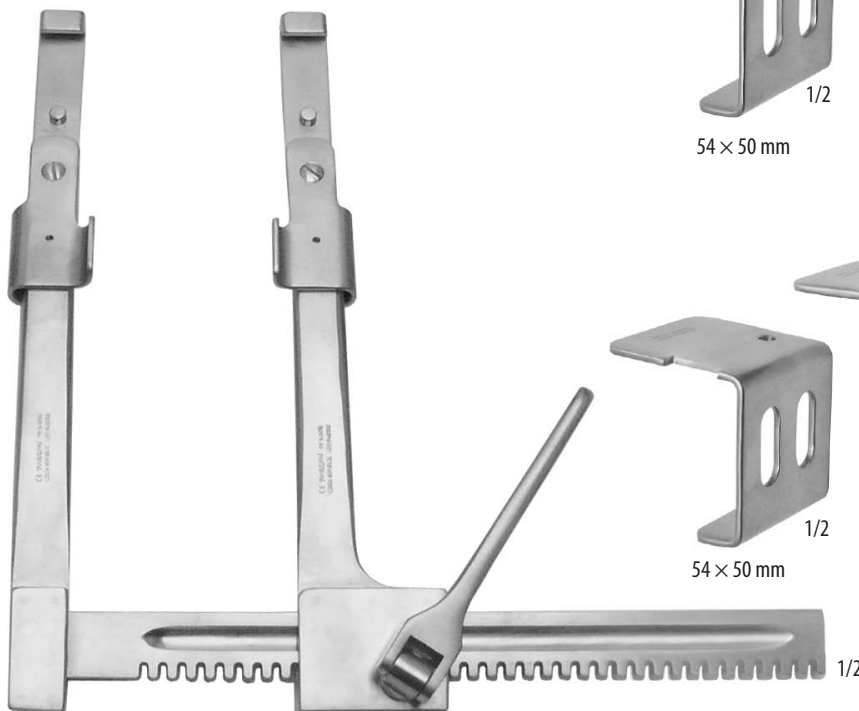

FINOCHIETTO
119 14 0050
sada – set
21,5 cm

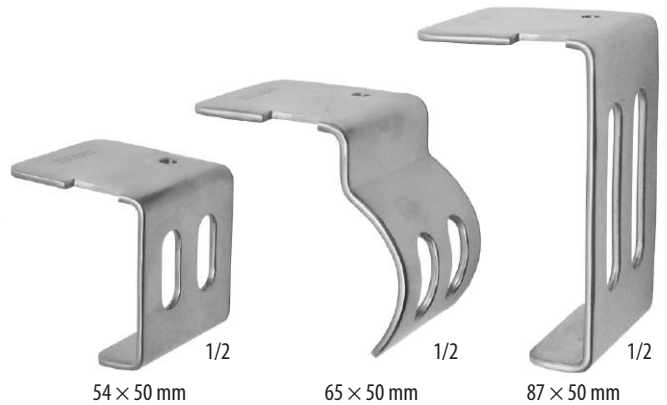

54 × 50 mm

65 × 50 mm

87 × 50 mm

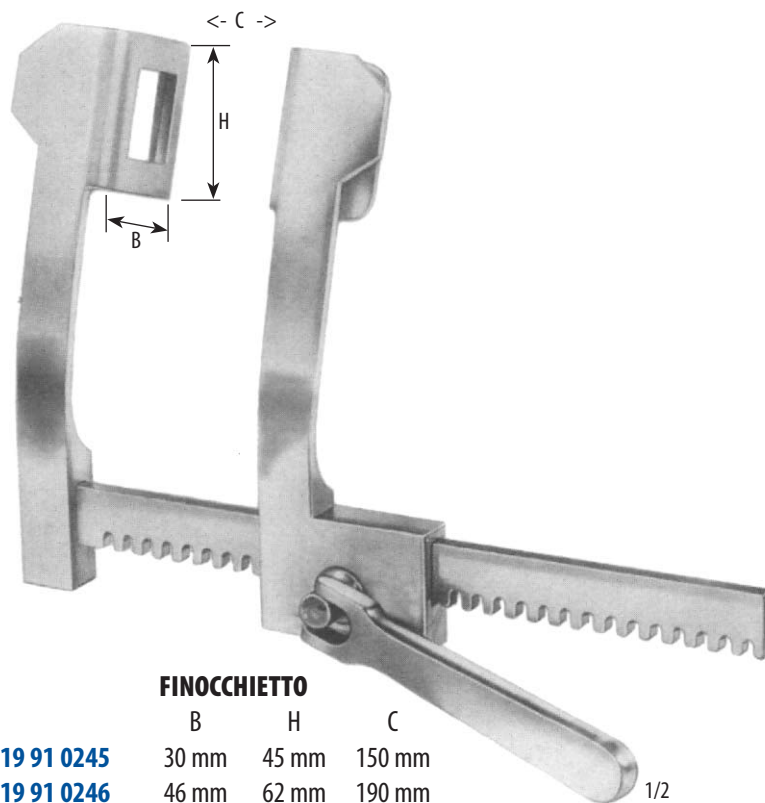
**FINOCCHIETTO**

	B	H	C
119 91 0245	30 mm	45 mm	150 mm
119 91 0246	46 mm	62 mm	190 mm
119 91 0247	80 mm	65 mm	190 mm

**FINOCCHIETTO-BABY**

	B	H	C
119 91 0244	14 mm	15 mm	75 mm

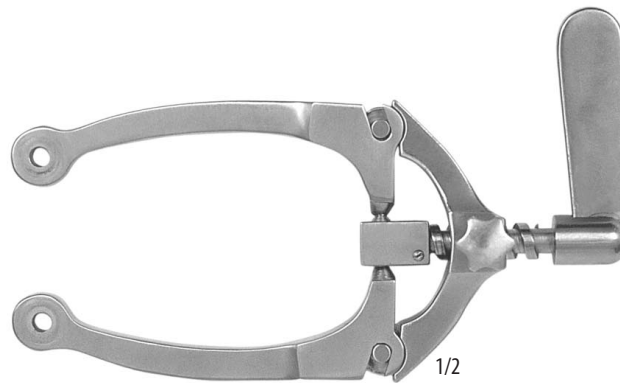

1/2

GOTFRÝD
119 99 0026
16,5 cm



1/1

119 99 0030
ostrá – sharp

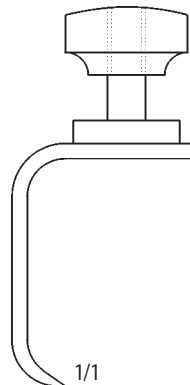

1/1

ostrá – sharp

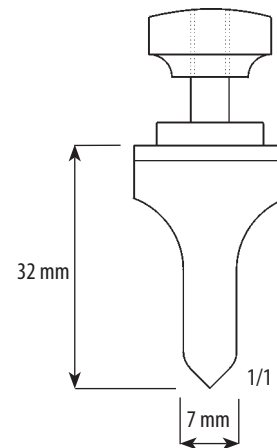

32 mm

7 mm

1/1



1/1

tupá – blade

119 99 0028
119 99 0029

A

B

42 mm 20 mm

52 mm 20 mm

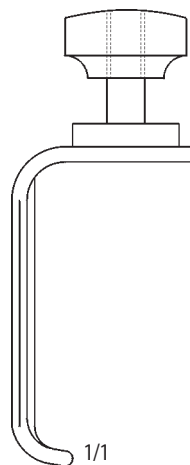

1/1

tupá – blade

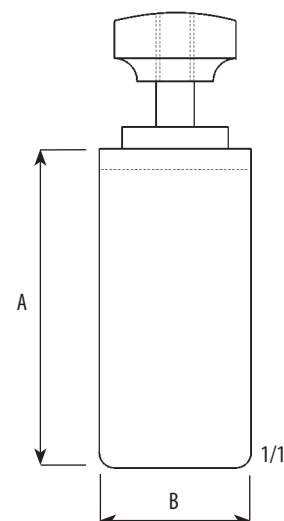

A

B

1/1

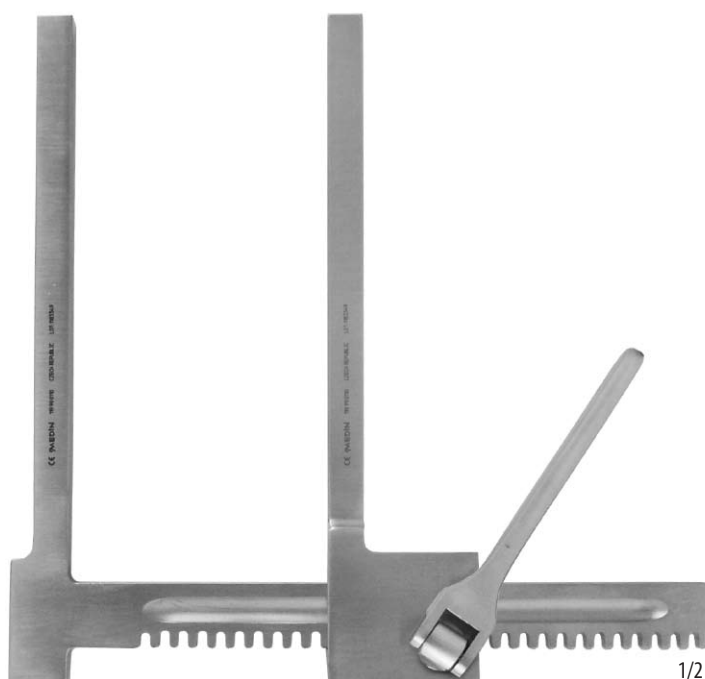

FINOCHIETTO
119 99 0110
18,5 × 18,0 cm



119 99 0111
10 × 30 mm



119 99 0112
10 × 45 mm



119 99 0113
10 × 60 mm



119 99 0114
10 × 75 mm

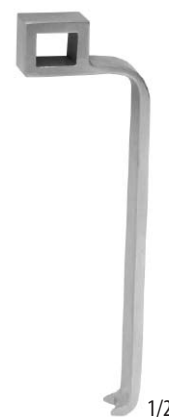

119 99 0115
10 × 90 mm



ostrý – sharp
119 17 0030
 32,2 cm
 (7 × 7)

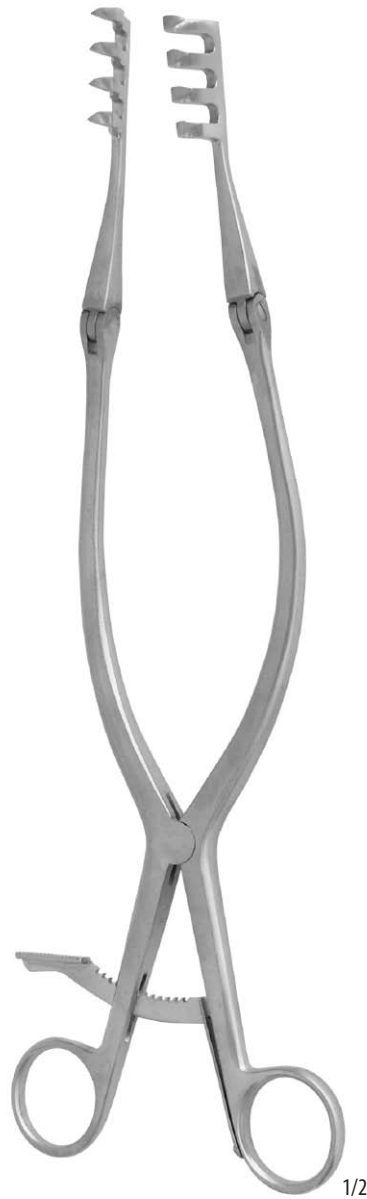

ostrý – sharp
119 17 0050
 32,2 cm
 (4 × 4)



tupý – blunt
119 17 0060
 32,0 cm
 (4 × 4)

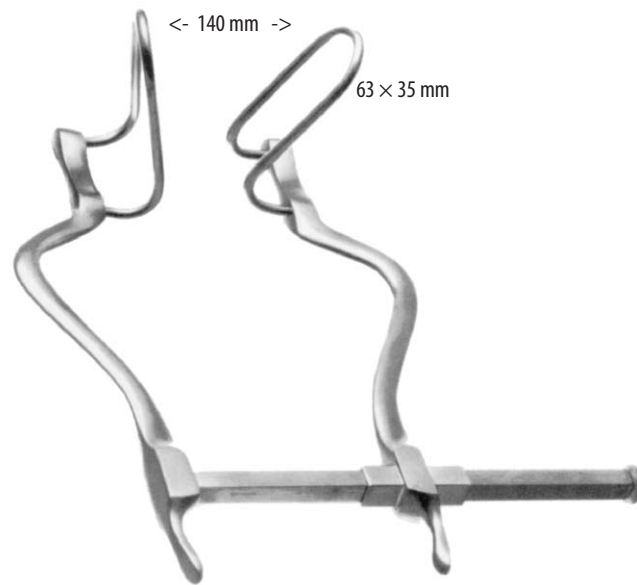

GOSSET
119 91 0118

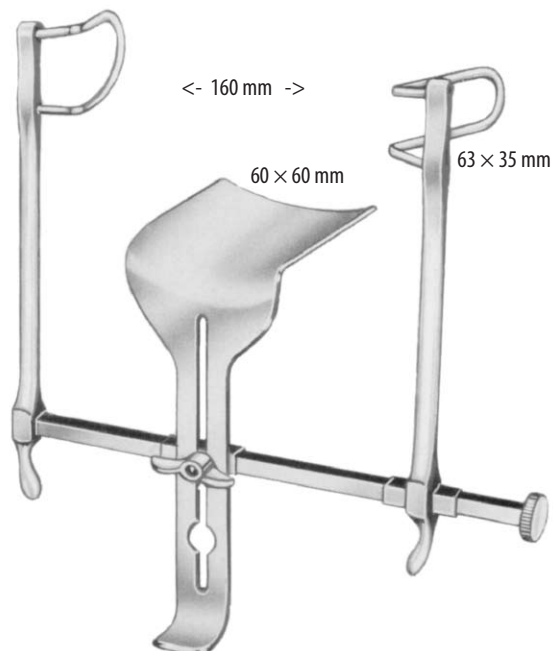

GOSSET
119 91 0119

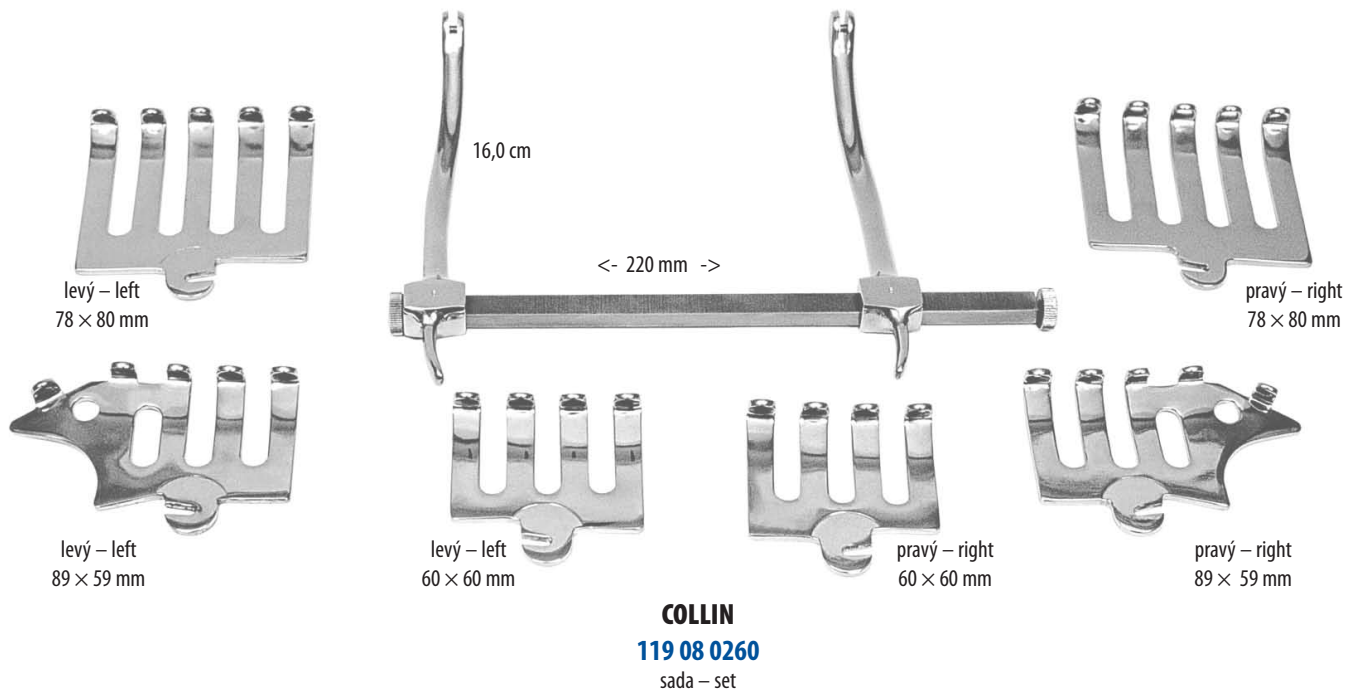
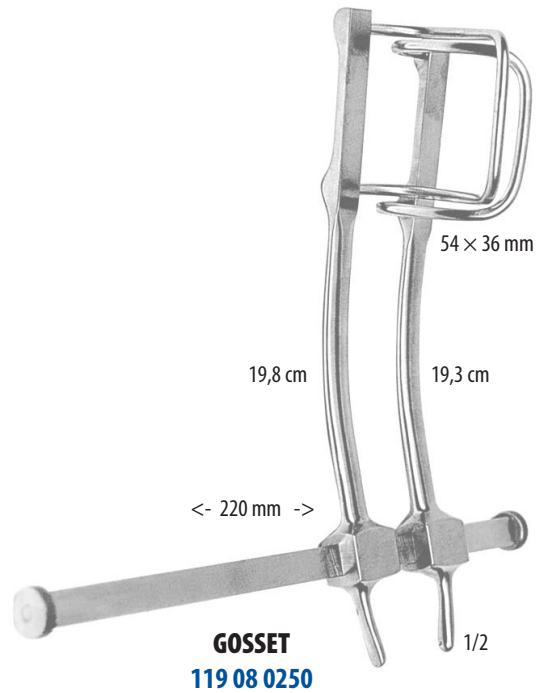

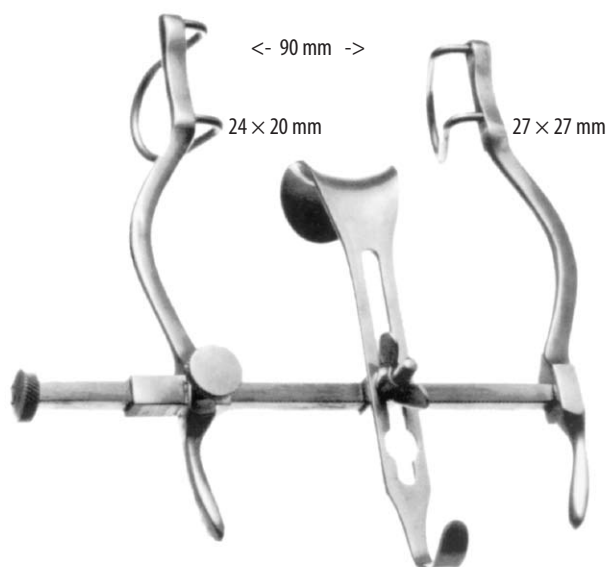
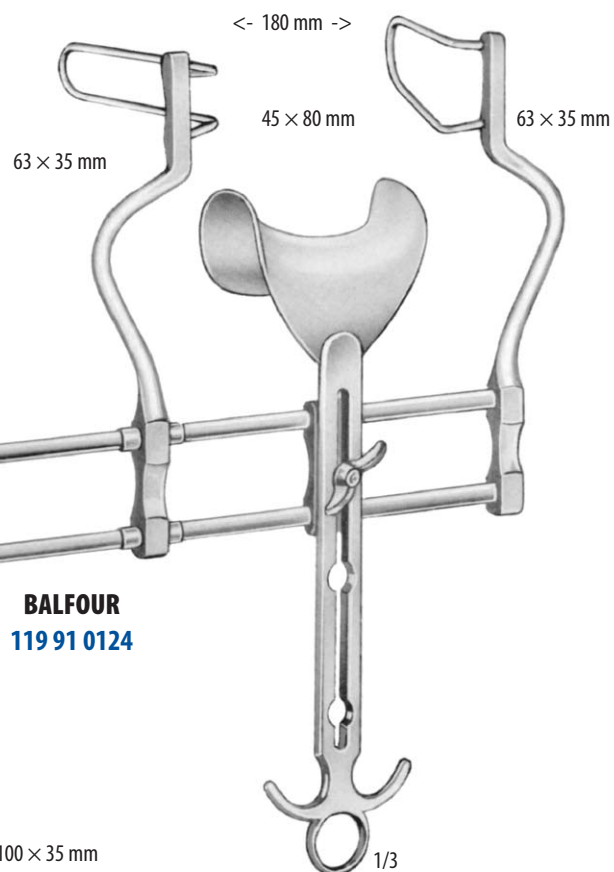
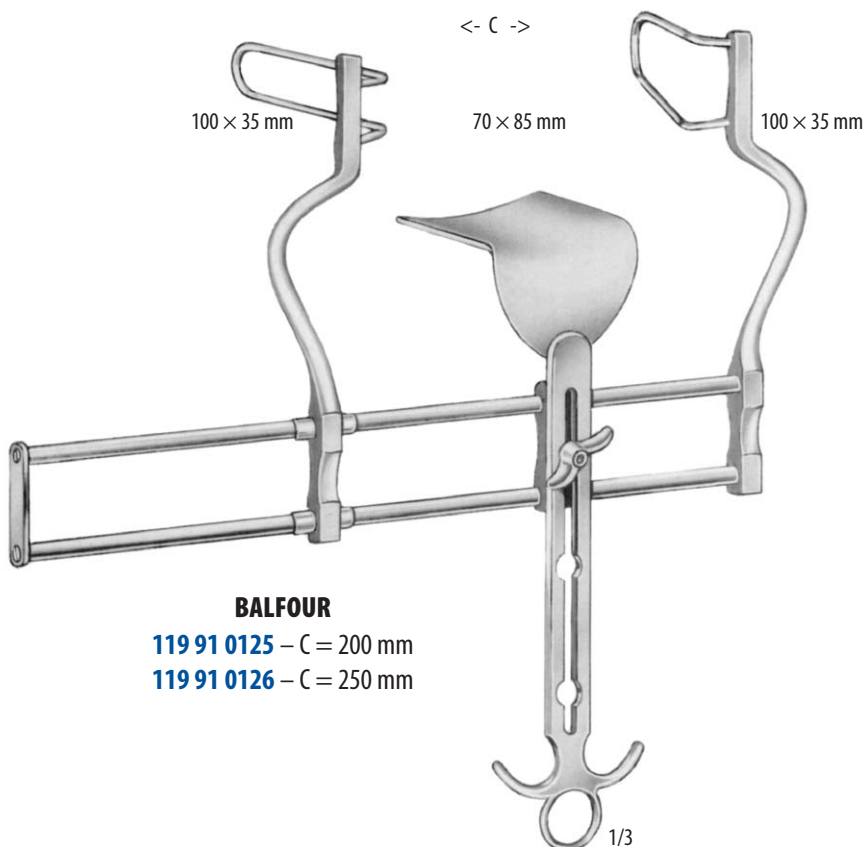
ROZVĚRAČE BŘIŠNÍ
ABDOMINAL RETRACTORS

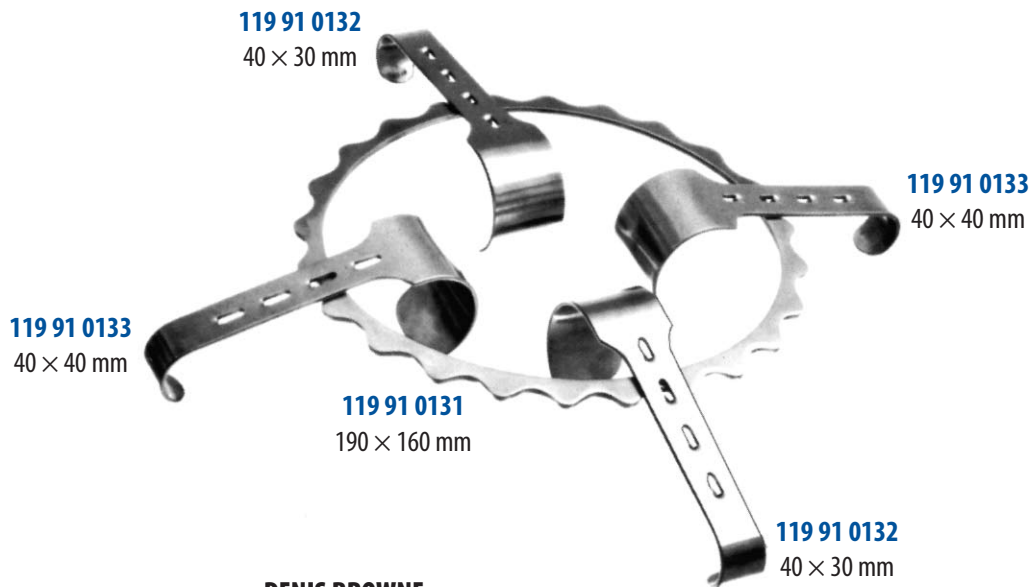
BALFOUR-BABY
119 91 0123

BALFOUR
119 91 0124

BALFOUR
119 91 0125 – C = 200 mm
119 91 0126 – C = 250 mm



119 91 0132
40 × 30 mm

119 91 0133
40 × 40 mm

119 91 0133
40 × 40 mm

119 91 0131
190 × 160 mm

119 91 0132
40 × 30 mm

DENIS BROWNE

119 91 0130 = 1 × **119 91 0131**
2 × **119 91 0132**
2 × **119 91 0133**

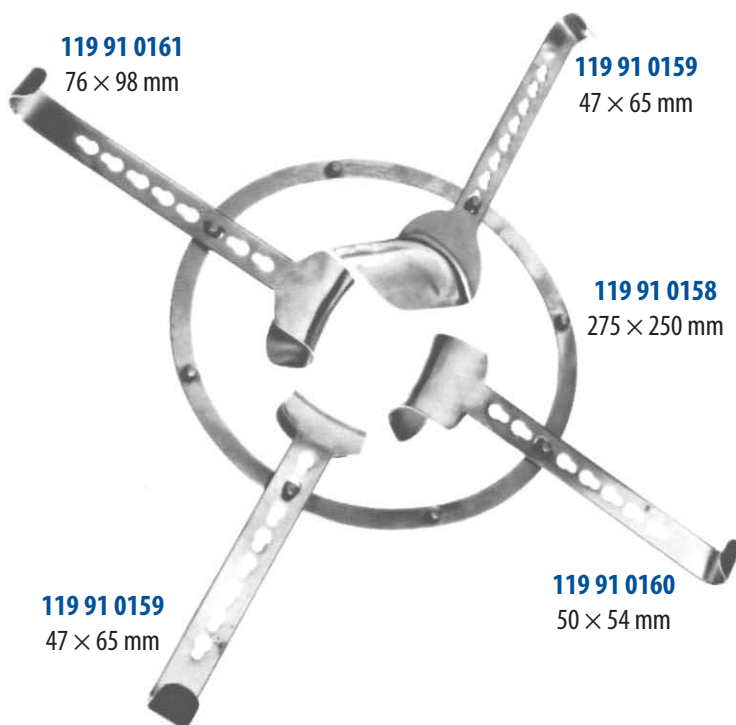

119 91 0161
76 × 98 mm

119 91 0159
47 × 65 mm

119 91 0158
275 × 250 mm

119 91 0159
47 × 65 mm

119 91 0160
50 × 54 mm



119 91 0162
98 × 52 mm



119 91 0163
105 × 35 mm

SEMM

119 91 0157 = 1 × **119 91 0158**
2 × **119 91 0159**
1 × **119 91 0160**
1 × **119 91 0161**
1 × **119 91 0162**
1 × **119 91 0163**



119 91 0135

119 91 0136
110 × 70 mm119 91 0137
80 × 45 mm**O'SULLIVAN-O'CONNOR**

119 91 0134 = 1 × 119 91 0135
1 × 119 91 0136
2 × 119 91 0137

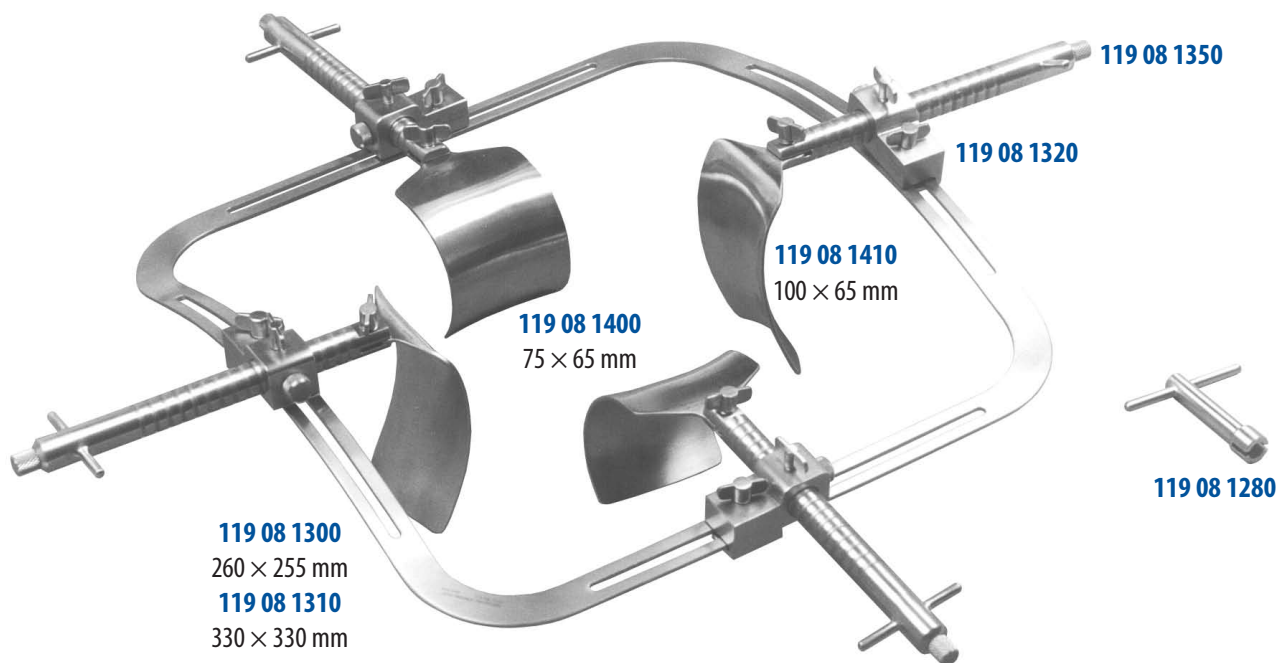

139 08 0050 = 1 × 119 08 1300
1 × 119 08 1310
4 × 119 08 1320
4 × 119 08 1350
2 × 119 08 1400
2 × 119 08 1410
1 × 119 08 1280

119 91 0143
300 × 300 mm



119 91 0144
38 × 60 mm

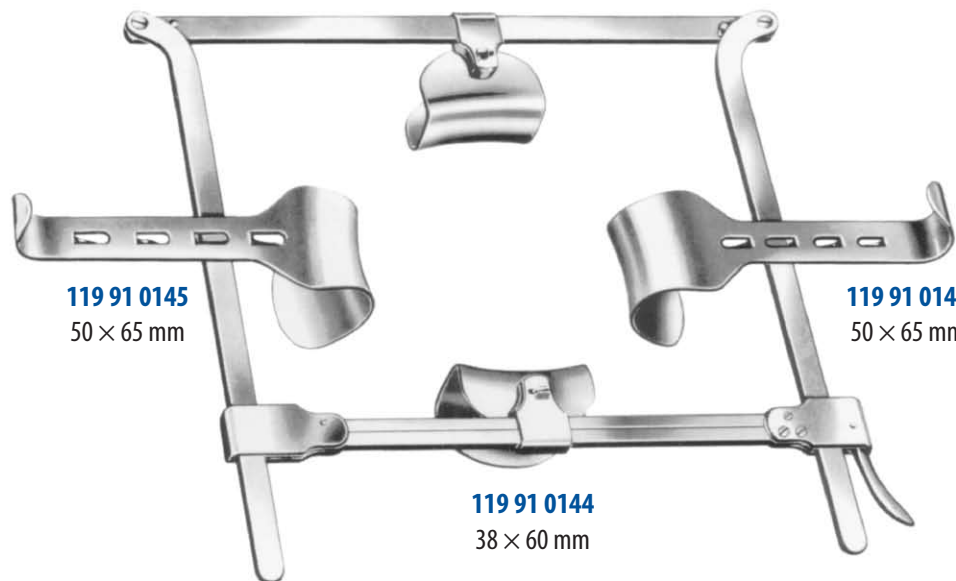

119 91 0145
50 × 65 mm

119 91 0145
50 × 65 mm

119 91 0144
38 × 60 mm

FRANZ

119 91 0142 = 1 × **119 91 0143**
2 × **119 91 0144**
2 × **119 91 0145**

119 91 0147
45 × 80 mm



119 91 0148
60 × 85 mm

119 91 0148
60 × 85 mm

119 91 0147
45 × 80 mm

FRANZ
119 91 0146 = 1 × **119 91 0143**
2 × **119 91 0144**
2 × **119 91 0145**
2 × **119 91 0147**
2 × **119 91 0148**



119 91 0149
105 × 35 mm

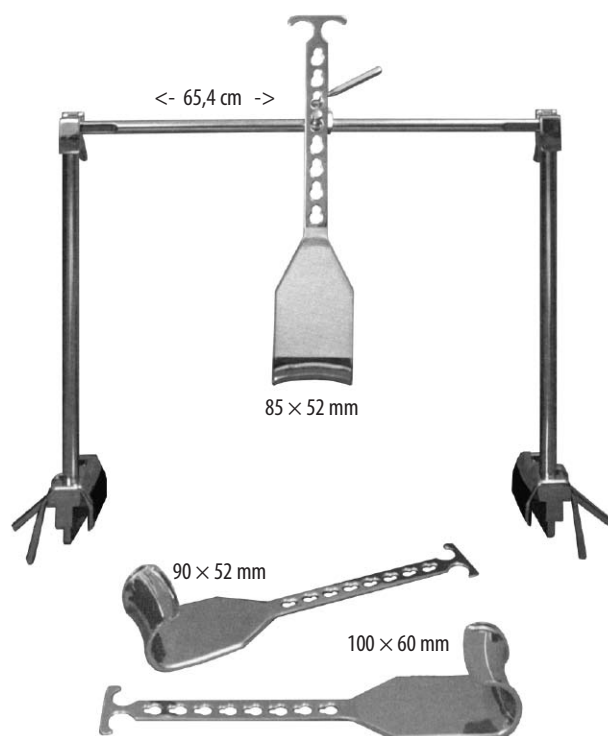
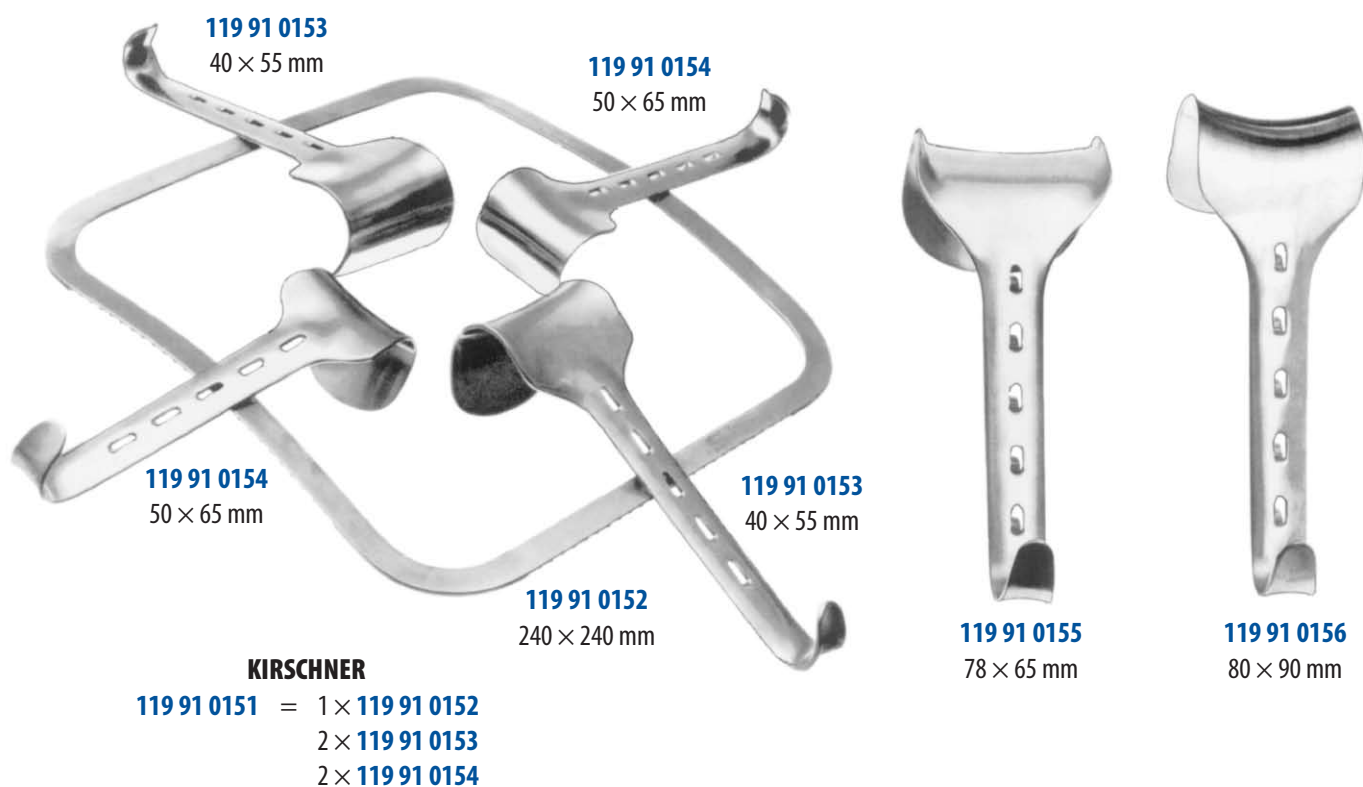

119 91 0150
98 × 50 mm

ROZVĚRAČE BŘIŠNÍ
ABDOMINAL RETRACTORS

ROCHARD
119 91 0283

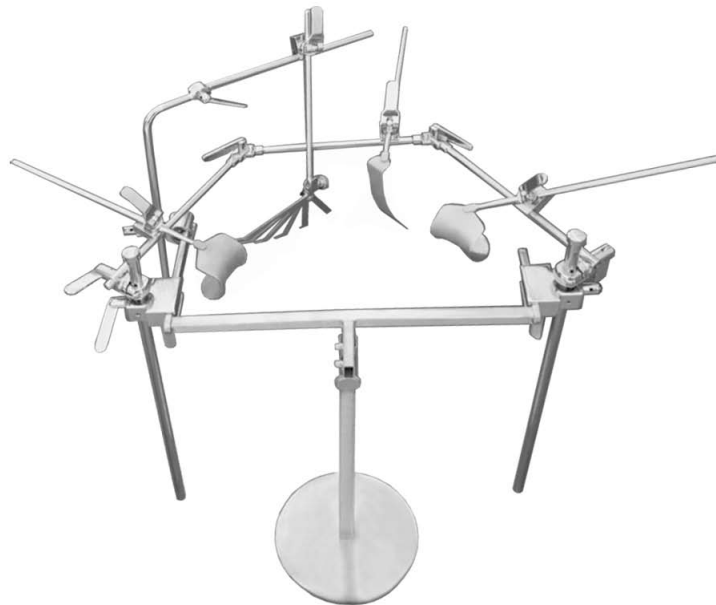
nastavení lišt individuální podle typu stolu
 setting of lathes is individual according to type of table



ROZVĚRAČ BŘIŠNÍ NA OPERACI JATER
ABDOMINAL RETRACTOR FOR LIVER OPERATION

119 91 0494

komplet – complete

HÁKY	HOOKS	60×60 mm	4×
HÁKY	HOOKS	80×80 mm	2×
HÁKY	HOOKS	35×230 mm	2×
HÁK PROHNUTÝ	HOOK SWAN-NECK SHAPE	50×280 mm	1×
HÁK	HOOK	65×230 mm	1×
RETRAKTOR	RETRACTOR	50×220 mm	1×



119 91 0166
30 × 44 mm



119 91 0165
23 × 44 mm

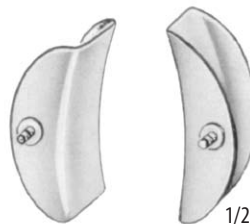

COLLIN-BABY
komplet – complete
119 91 0164
18,0 cm



COLLIN
119 91 0169
22,0 cm

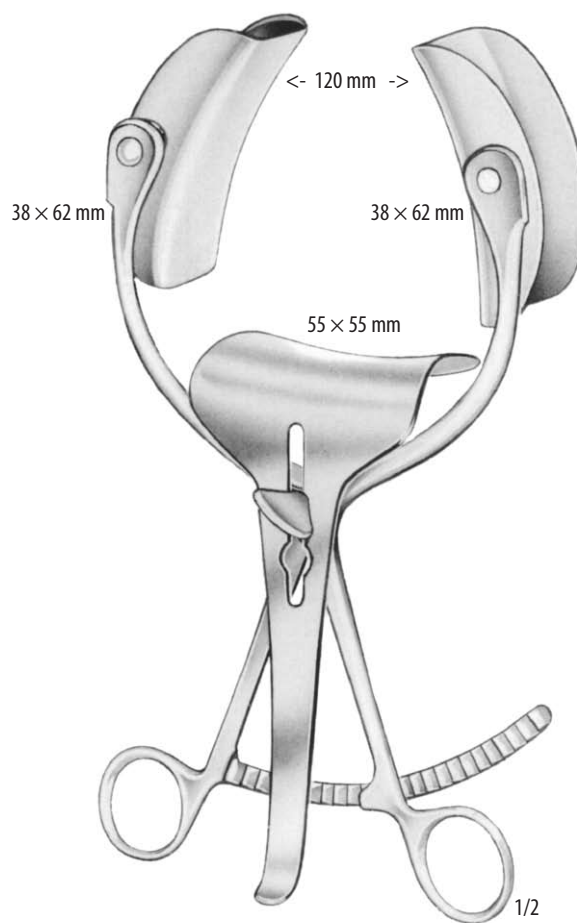

COLLIN
119 91 0170
22,0 cm

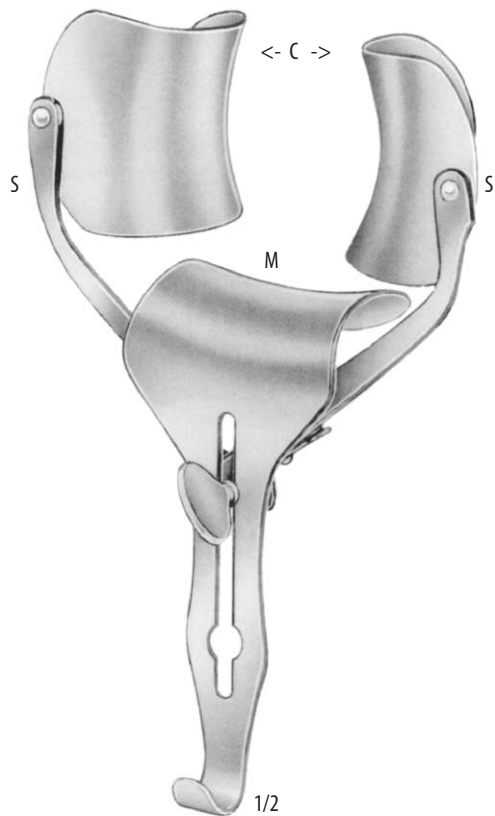
RICARD

	S	M	C
119 91 0173	72 × 85 mm	80 × 90 mm	280 mm
119 91 0174	60 × 80 mm	55 × 70 mm	300 mm

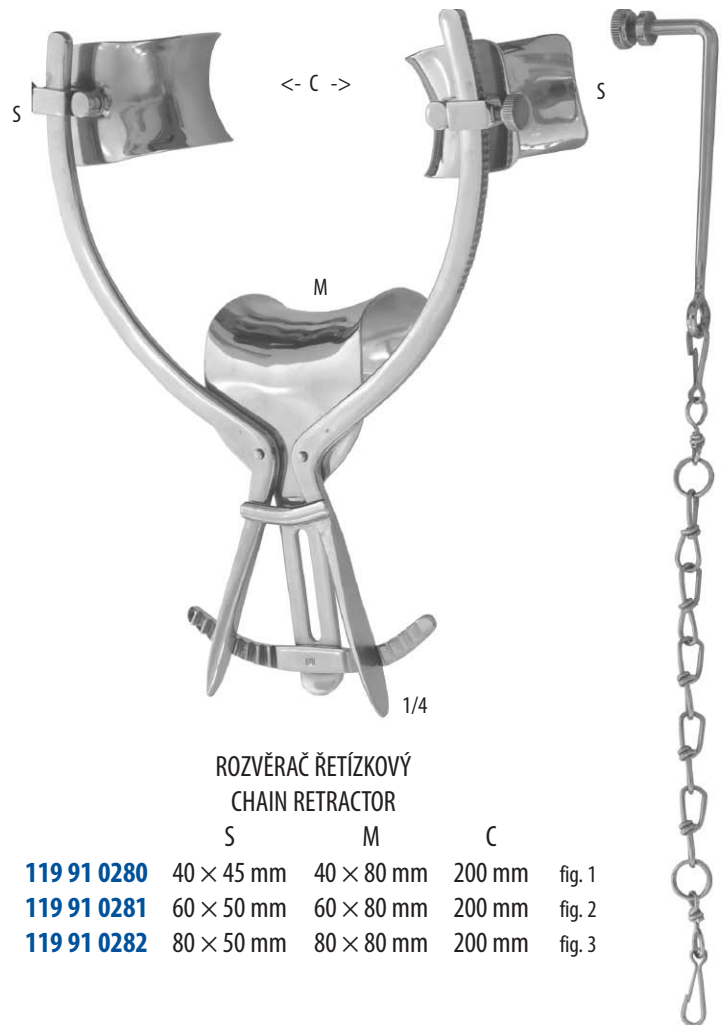
**ROZVĚRAČ ŘETÍZKOVÝ
CHAIN RETRACTOR**

	S	M	C	
119 91 0280	40 × 45 mm	40 × 80 mm	200 mm	fig. 1
119 91 0281	60 × 50 mm	60 × 80 mm	200 mm	fig. 2
119 91 0282	80 × 50 mm	80 × 80 mm	200 mm	fig. 3



1/2

PERCY
119 91 0184







REVERDIN
121 91 0012
29,0 cm
45/60 mm



LOPATKA BŘIŠNÍ
ABDOMINAL SPATULA
121 08 0050
33,0 cm
ohebná – malleable
40 mm

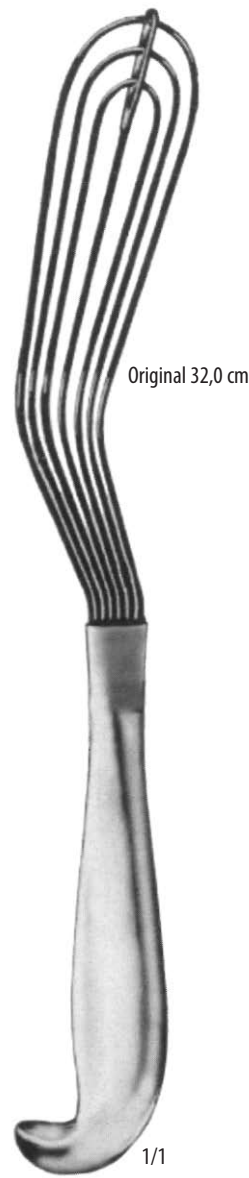

ALLISON
121 91 0027
26,0 cm
121 91 0028
32,0 cm

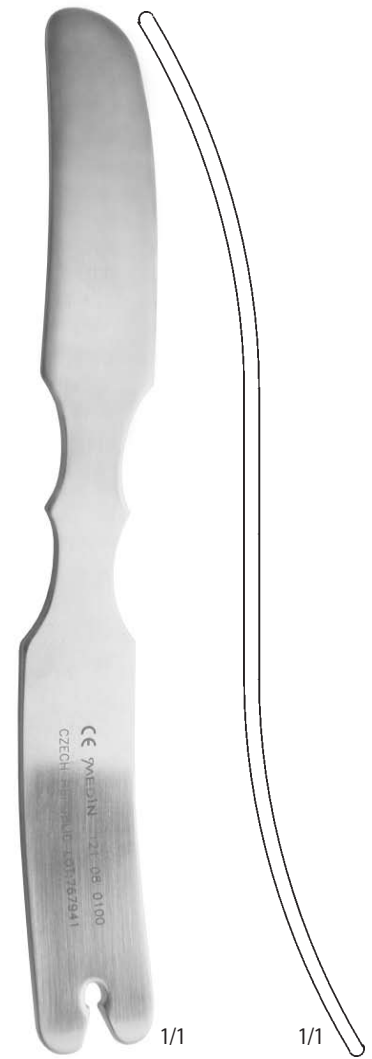

LOPATKA NA MAST
UNGUENT SPATULA
121 08 0100
14,0 cm
13/16 mm

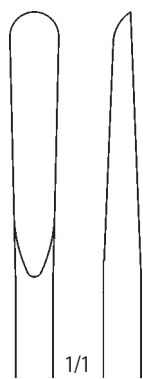

121 12 0020
Fig. 1

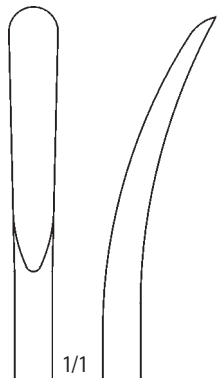

121 12 0030
Fig. 2



121 12 0040
Fig. 3

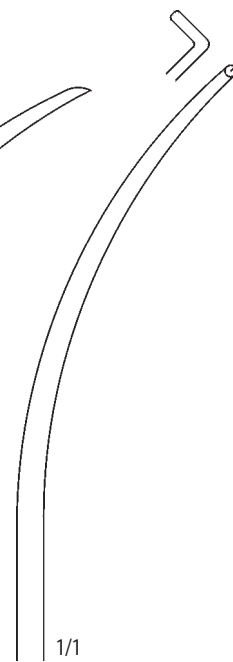

121 12 0050
Fig. 4

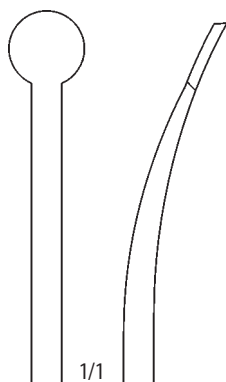

121 12 0060
Fig. 5

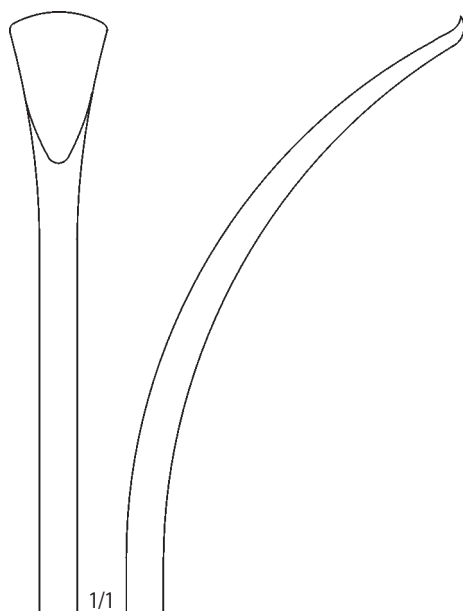

121 12 0070
Fig. 6

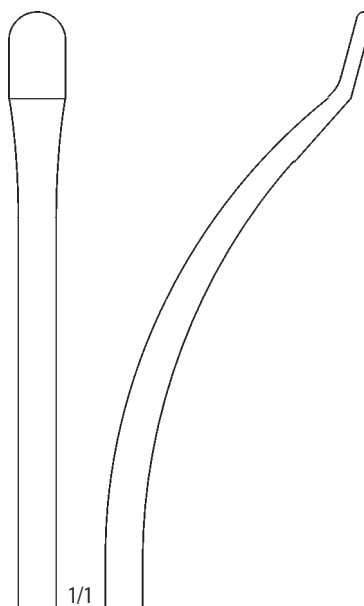

121 12 0080
Fig. 7



121 12 0080
25,2 cm



1/2

121 17 0040

 19,0 cm
10/8 mm

1/2

121 17 0050

 19,0 cm
14/12 mm

1/2

121 17 0060

 19,0 cm
16/14 mm

1/2

121 17 0070

 19,0 cm
21/16 mm

1/2

TUFFIER
121 22 0010

 ohebná – maleable
17,5 cm
16/23 mm

1/2

BUCHWALD
121 31 0010

 17,3 cm
16/23 mm

1/2

BRÜNINGS
121 31 0020

 19,5 cm
14/18 mm



1/2

JAEGER
121 38 0010

 10,7 cm
19/19 mm

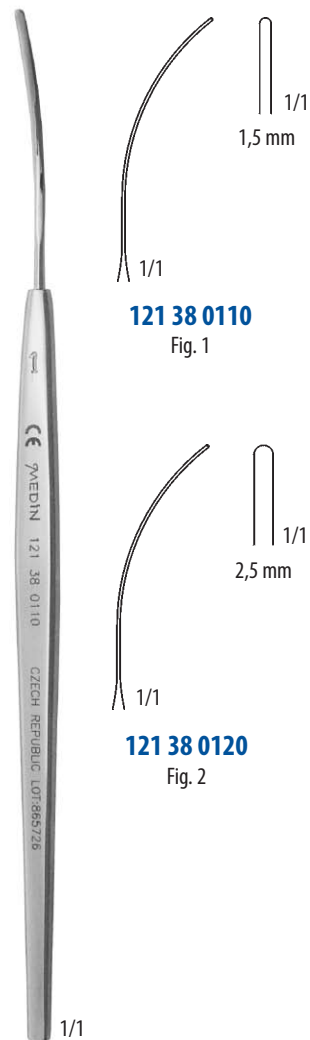

PAGENSTECHER
121 38 0020
14,5 cm



LOPATKA NA DUHOVKU
IRIS SPATULA
13,5 cm

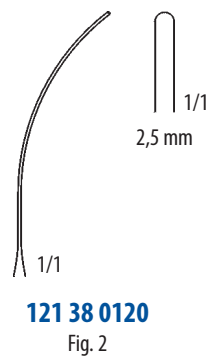

WEBER
121 38 0210
14,0 cm

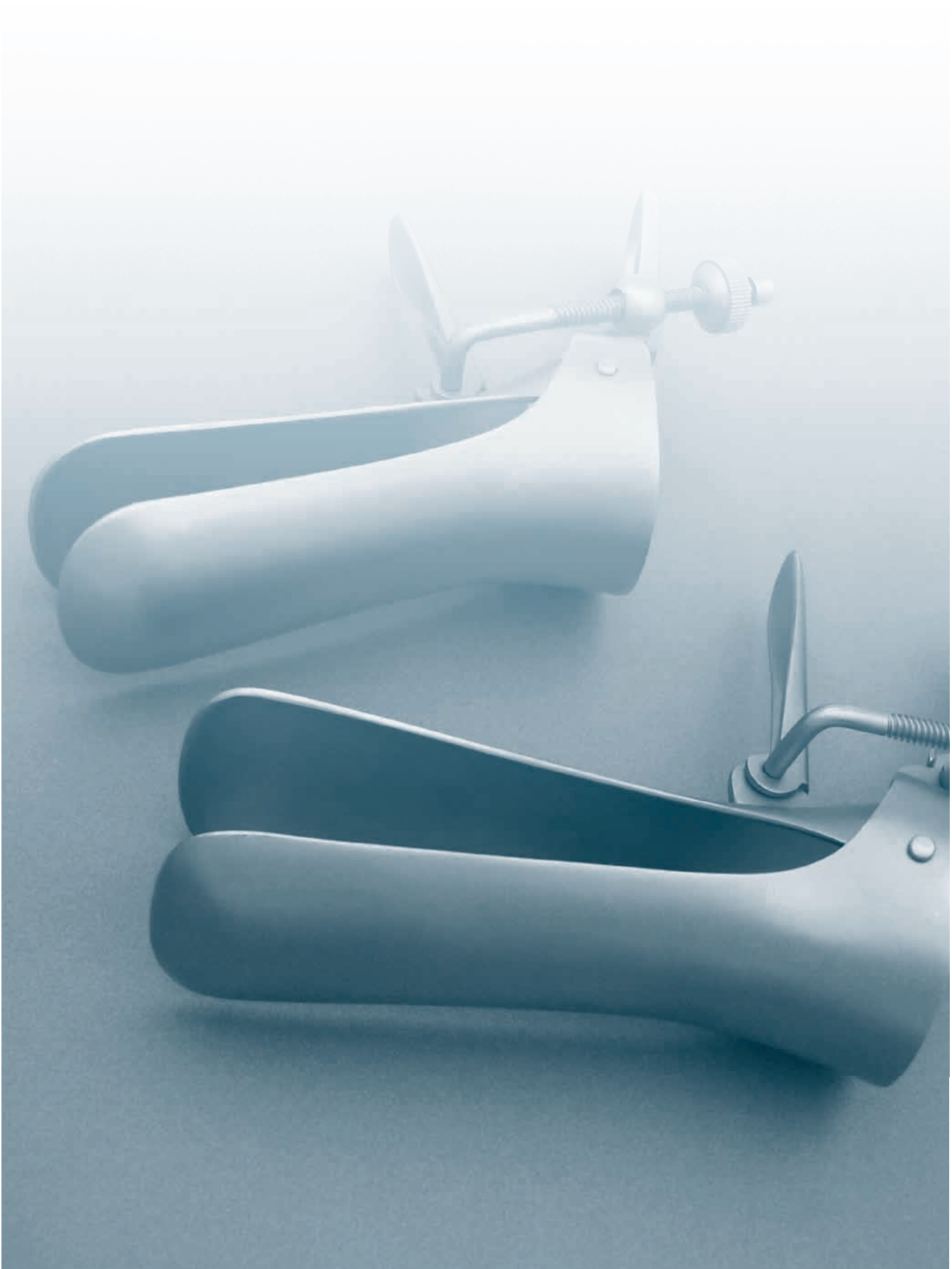





122 27 0350
23,8 cm



122 27 0370
24,0 cm



122 27 0380
23,5 cm



122 27 0400
23,5 cm

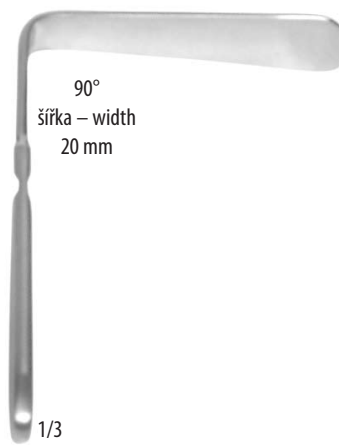

122 27 0420
16,9 cm



122 27 0440
16,9 cm

PÁKY POŠEVNÍ
VAGINAL ELEVATORS

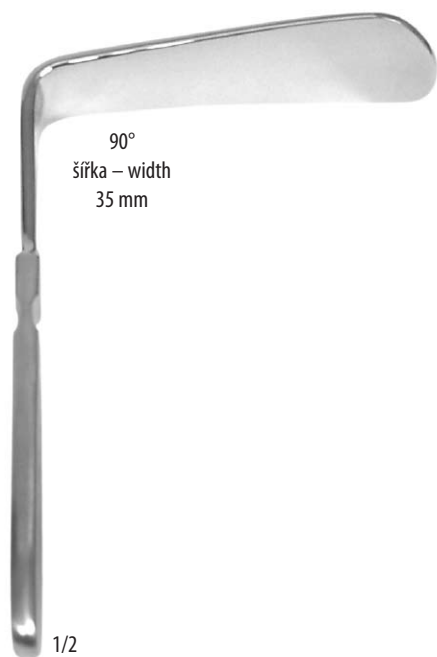

122 27 0450
16,9 cm





122 27 0470
16,9 cm

ZRCADLA POŠEVNÍ
VAGINAL SPECULA

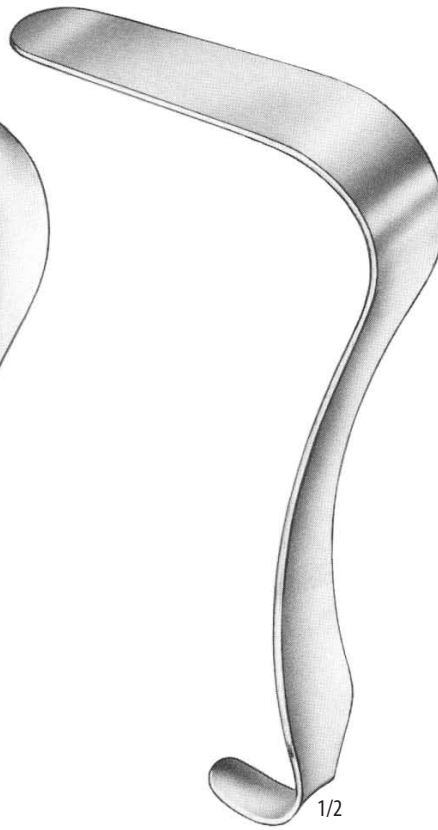

KRISTELLER
122 27 0490
sada – set
22,4 cm

KRISTELLER

		a × b
	Fig. 1 122 91 0094	70 × 27 mm
	Fig. 2 122 91 0095	80 × 30 mm
	Fig. 3 122 91 0096	90 × 36 mm
kuželovité conic	Fig. 00 122 91 0103	105 × 18 mm
	Fig. 0 122 91 0104	105 × 21 mm
	Fig. 1 122 91 0109	105 × 26 mm
	Fig. 2 122 91 0110	105 × 28 mm
	Fig. 3 122 91 0111	105 × 33 mm
	Fig. 1 122 91 0118	110 × 27 mm
	Fig. 2 122 91 0119	110 × 30 mm
	Fig. 3 122 91 0120	110 × 36 mm

KRISTELLER

		a × b
Fig. 1	122 91 0097	75 × 23 mm
Fig. 2	122 91 0098	85 × 26 mm
Fig. 3	122 91 0099	100 × 32 mm
Fig. 00	122 91 0105	110 × 14 mm
Fig. 0	122 91 0106	110 × 17 mm
Fig. 1	122 91 0112	115 × 22 mm
Fig. 2	122 91 0113	115 × 24 mm
Fig. 3	122 91 0114	115 × 29 mm
Fig. 1	122 91 0121	115 × 23 mm
Fig. 2	122 91 0122	115 × 26 mm
Fig. 3	122 91 0123	115 × 32 mm

KRISTELLER

sada – set	
122 91 0100	
122 91 0101	
122 91 0102	
122 91 0107	
122 91 0108	
122 91 0115	
122 91 0116	
122 91 0117	
122 91 0124	
122 91 0125	
122 91 0126	

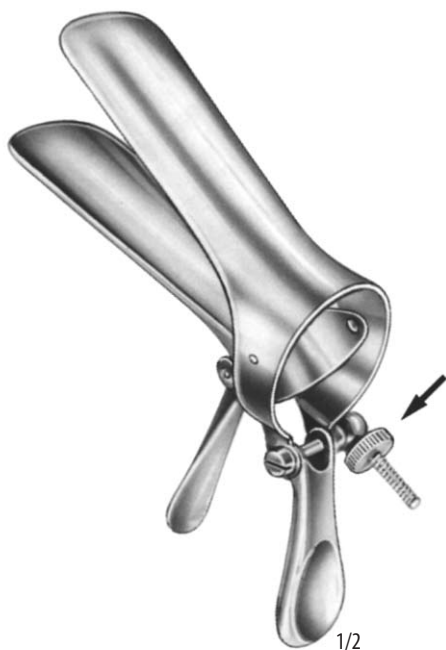
**CUSCO****122 91 0001** 75 × 32 mm**122 91 0002** 85 × 35 mm**122 91 0003** 100 × 35 mm**CUSCO-VIRGIN****122 91 0004**

75 × 17 mm

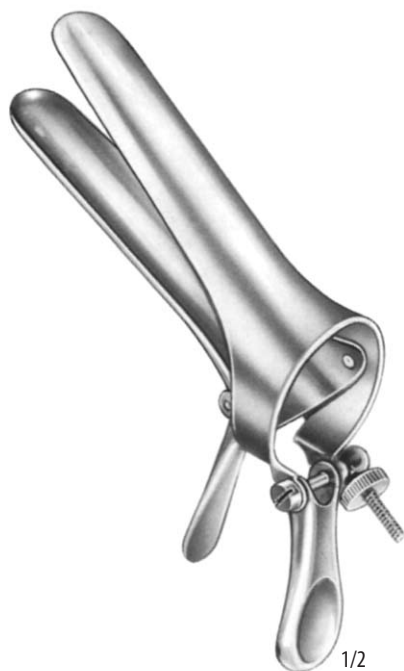
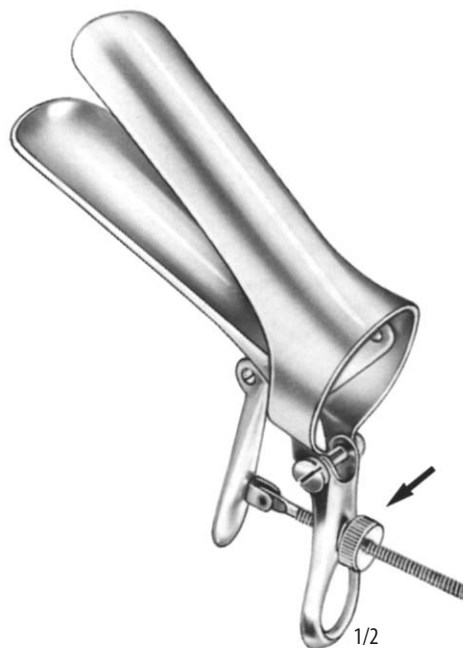
**CUSCO-SUISSE****122 91 0005** 80 × 22 mm**122 91 0006** 100 × 25 mm**122 91 0007** 105 × 27 mm**CUSCO****122 91 0008** 74 × 32 mm**122 91 0009** 85 × 35 mm**122 91 0010** 100 × 37 mm

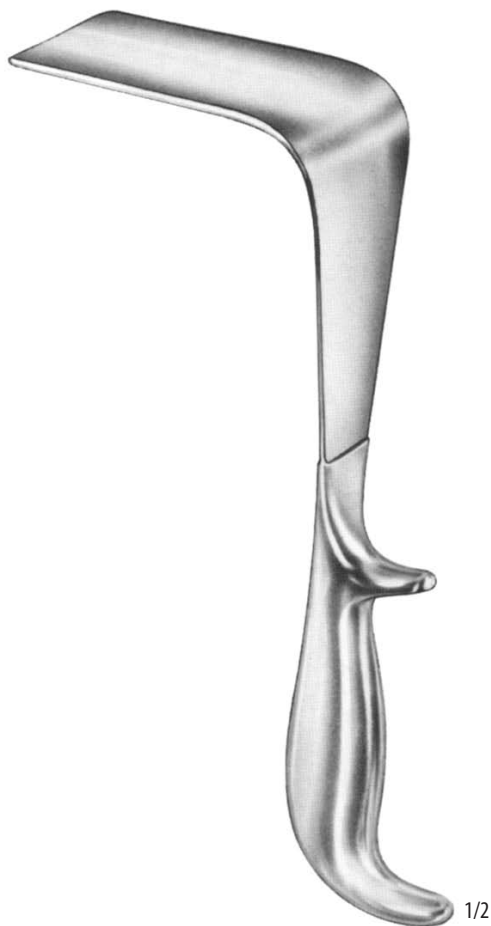
DOYEN

		a × b
Fig. 1	122 91 0127	55 × 35 mm
Fig. 2	122 91 0128	85 × 35 mm
Fig. 3	122 91 0129	115 × 36 mm
Fig. 1	122 91 0130	55 × 45 mm
Fig. 2	122 91 0131	85 × 45 mm
Fig. 3	122 91 0132	115 × 45 mm
Fig. 1	122 91 0133	55 × 60 mm
Fig. 2	122 91 0134	85 × 60 mm
Fig. 3	122 91 0135	115 × 60 mm

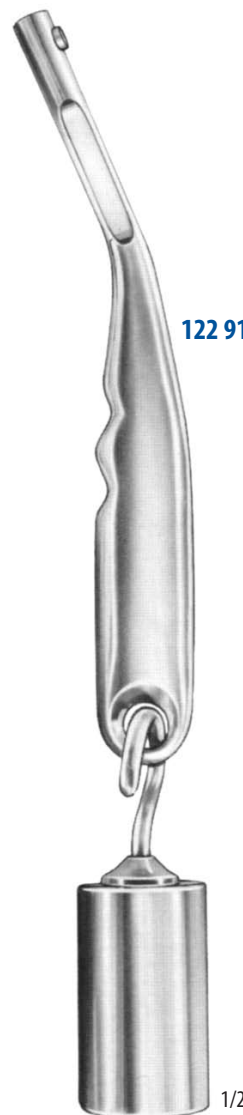
SCHERBACK

122 91 0143 – 400 g
122 91 0144 – 800 g

122 91 0136
sada – set
122 91 0137
122 91 0138
122 91 0139
122 91 0140
122 91 0141
122 91 0142
122 91 0143

122 91 0145
sada – set
122 91 0137
122 91 0138
122 91 0139
122 91 0140
122 91 0141
122 91 0142
122 91 0144



122 91 0137



122 91 0138

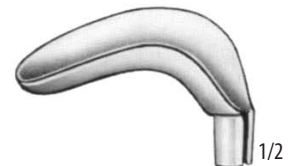

122 91 0139



122 91 0140

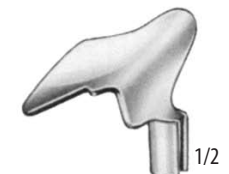

122 91 0141

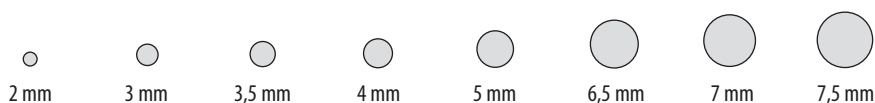

dětské – for children

HARTMANN

122 91 0205 – Fig. 0–2
sada – set

122 91 0206 – Fig. 0

2,0 mm

122 91 0207 – Fig. 1

3,5 mm

122 91 0208 – Fig. 2

5,0 mm



pro dospělé – for adults

HARTMANN

122 91 0212 – Fig. 1–4
sada – set

122 91 0207 – Fig. 1

3,5 mm

122 91 0208 – Fig. 2

5,0 mm

122 91 0209 – Fig. 3

6,5 mm

122 91 0210 – Fig. 4

7,5 mm



černý – black

HARTMANN

122 91 0217 – Fig. 0–3
sada – set

122 91 0213 – Fig. 0

3,0 mm

122 91 0214 – Fig. 1

4,0 mm

122 91 0215 – Fig. 2

5,0 mm

122 91 0216 – Fig. 3

7,0 mm

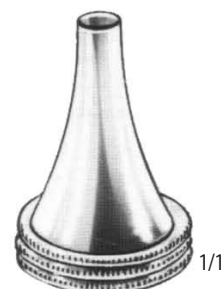
**POLITZER**

122 91 0200 – Fig. 1–3
sada – set

122 91 0201 – Fig. 1

2,0 mm

122 91 0202 – Fig. 2

3,0 mm

122 91 0203 – Fig. 3

4,0 mm

122 91 0204 – Fig. 4

5,0 mm

HARTMANN

122 91 0211 – Fig. 2–4
sada – set

122 91 0208 – Fig. 2

5,0 mm

122 91 0209 – Fig. 3

6,5 mm

122 91 0210 – Fig. 4

7,5 mm



HARTMANN
122 30 0010
14,0 cm
Fig. 1



HARTMANN
122 30 0020
14,3 cm
Fig. 2



KILLIAN
122 30 0100
14,7 cm
Fig. 1



KILLIAN
122 30 0110
15,0 cm
Fig. 2



KILLIAN
122 30 0120
15,7 cm
Fig. 3

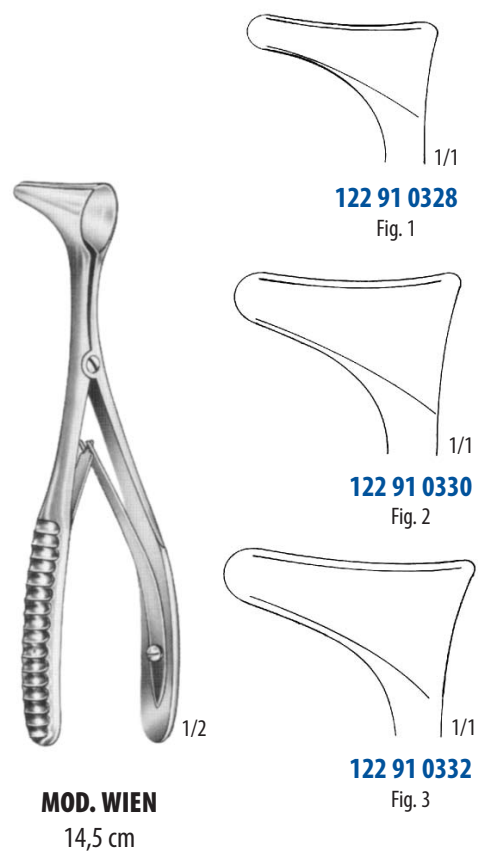
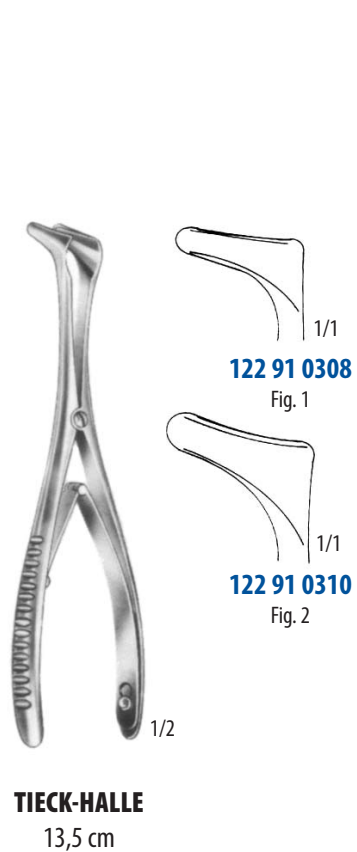
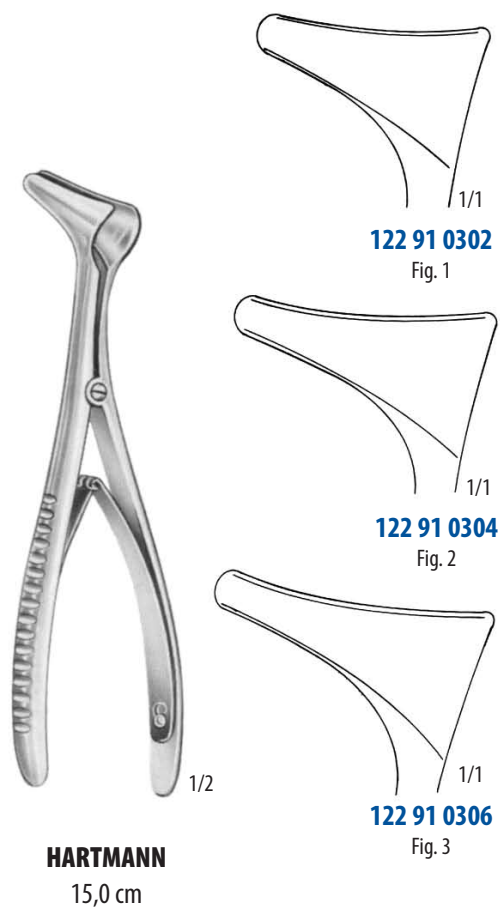
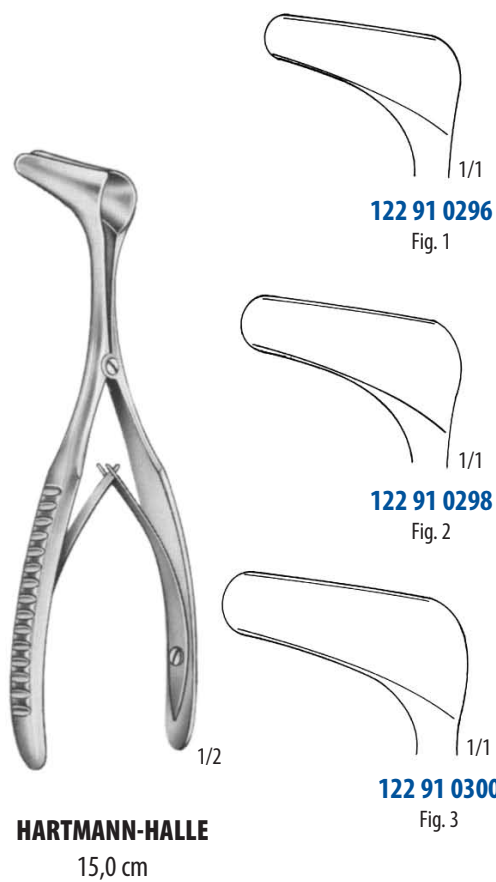

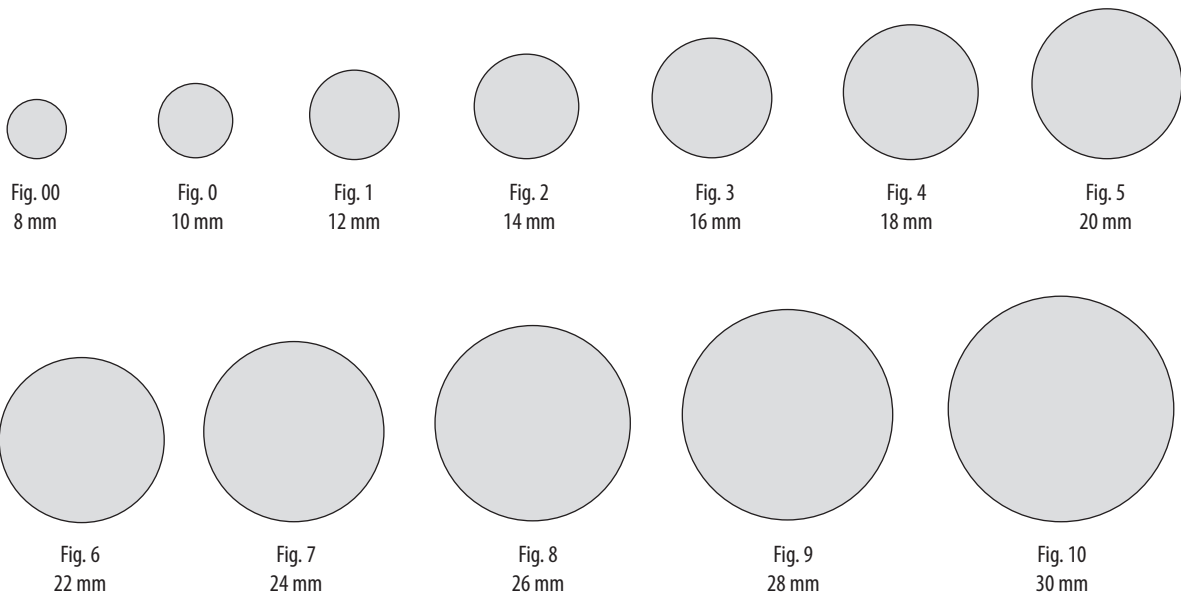

DRŽADLO HRTANOVÝCH ZRCÁTEK
HANDLE
122 91 0172



Fig. 00	122 91 0173
Fig. 0	122 91 0174
Fig. 1	122 91 0175
Fig. 2	122 91 0176
Fig. 3	122 91 0177
Fig. 4	122 91 0178
Fig. 5	122 91 0179
Fig. 6	122 91 0180
Fig. 7	122 91 0181
Fig. 8	122 91 0182
Fig. 9	122 91 0183
Fig. 10	122 91 0184



Fig. 00	122 91 0185
Fig. 0	122 91 0186
Fig. 1	122 91 0187
Fig. 2	122 91 0188
Fig. 3	122 91 0189
Fig. 4	122 91 0190
Fig. 5	122 91 0191
Fig. 6	122 91 0192
Fig. 7	122 91 0193
Fig. 8	122 91 0194
Fig. 9	122 91 0195
Fig. 10	122 91 0196

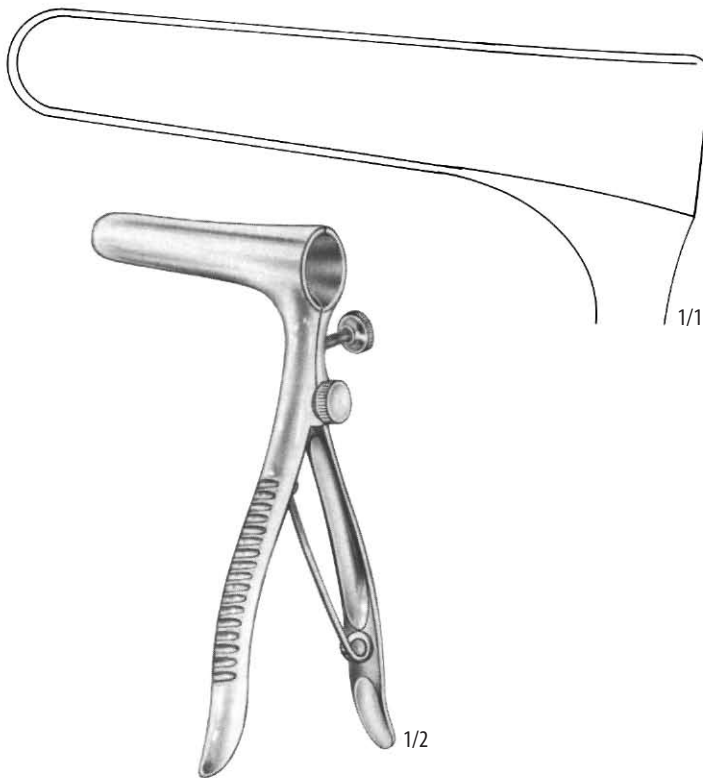

SIMS
122 91 0365
15,0 cm

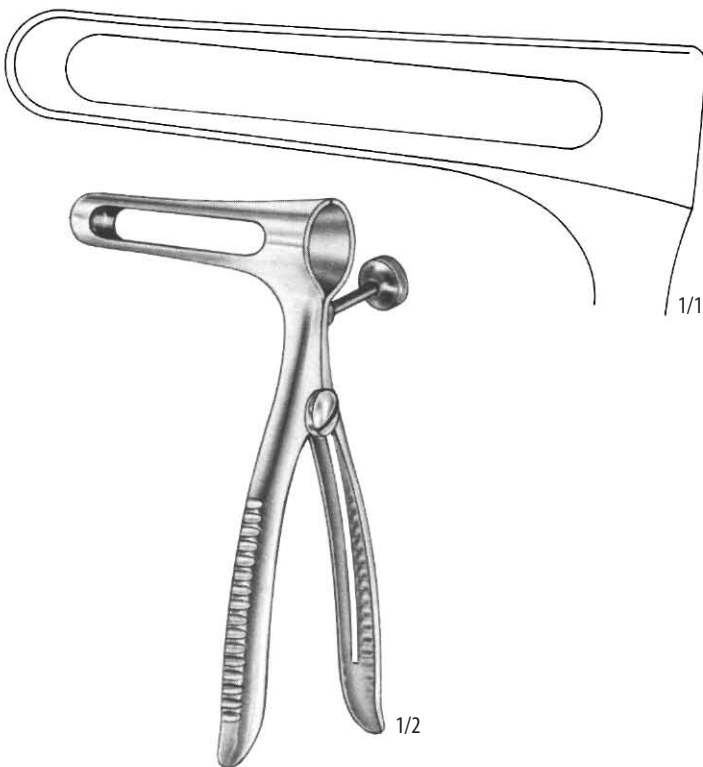

SIMS
122 91 0366
15,0 cm



PRATT
122 91 0371
21,5 cm
85 × 25 mm



IVES-FANSLER
122 91 0382
ø 22 mm



HIRSCHMANN
122 91 0385 ø 16 mm × 65 mm
122 91 0386 ø 19 mm × 65 mm
122 91 0387 ø 22 mm × 65 mm
122 91 0388 ø 22 mm × 125 mm



BENSAUDE
122 91 0394 ø 19 mm × 70 mm
122 91 0395 ø 22 mm × 70 mm

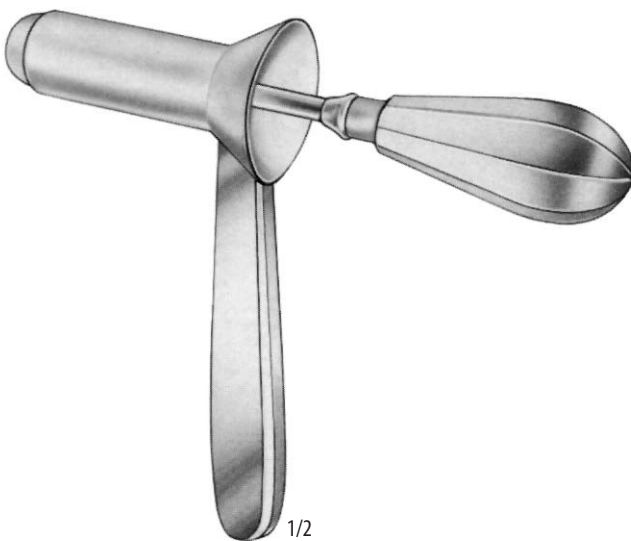

KELLY
122 91 0396 ø 22 mm × 50 mm
122 91 0397 ø 22 mm × 100 mm
122 91 0398 ø 22 mm × 140 mm
122 91 0399 ø 22 mm × 200 mm



KELLY
122 91 0400 ø 21 mm × 50 mm
122 91 0401 ø 27 mm × 50 mm

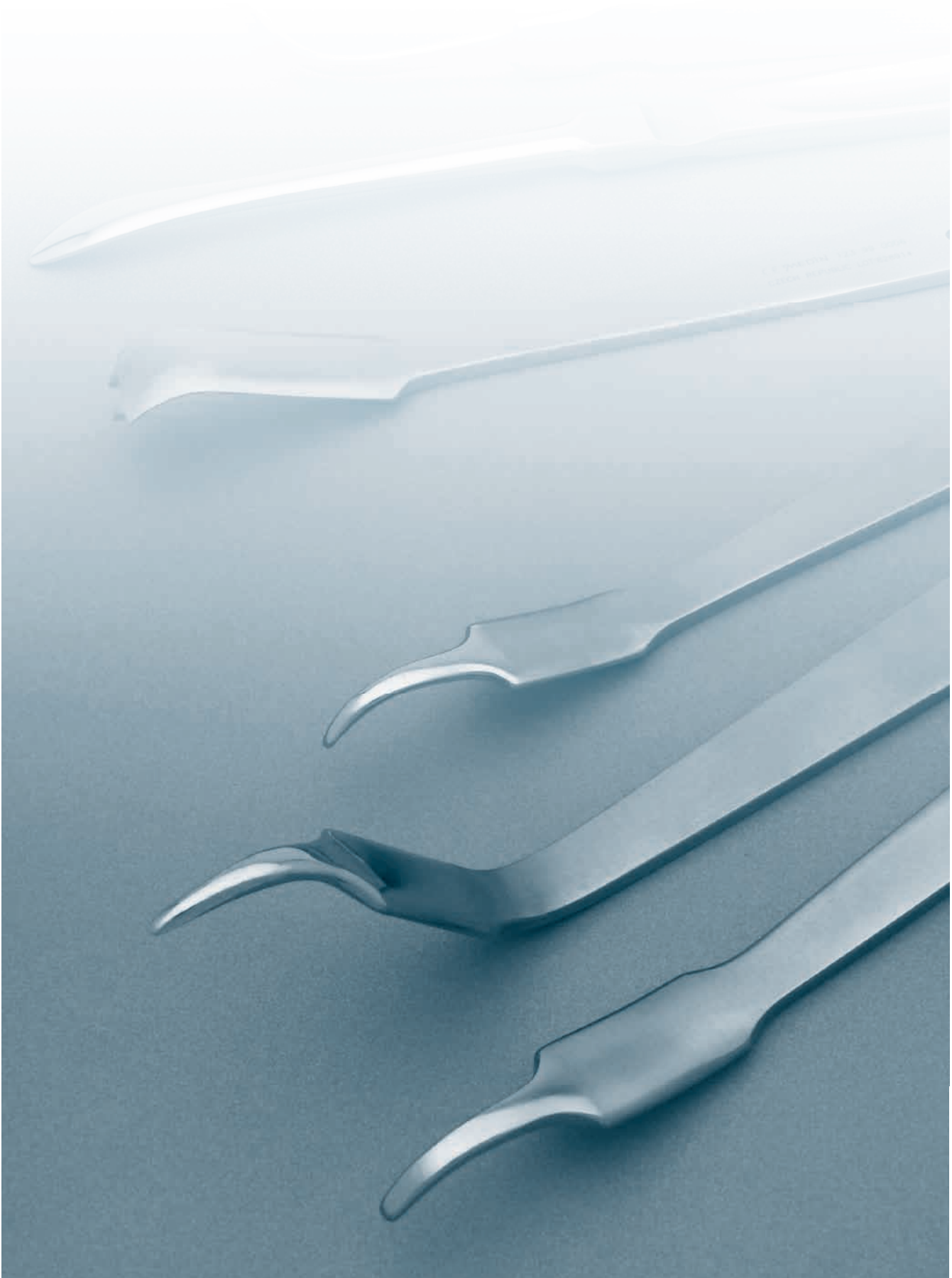



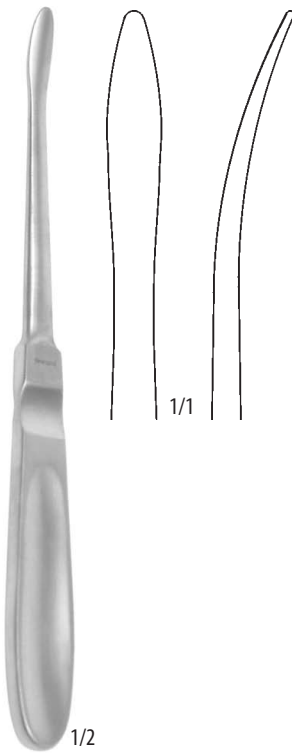

LANGENBECK
123 08 0010
19,5 cm

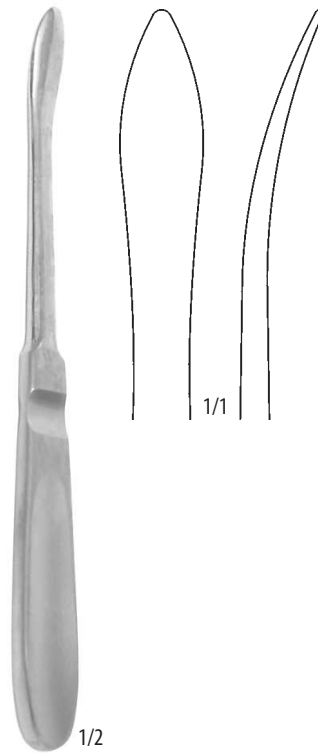

LANGENBECK
123 08 0020
19,5 cm

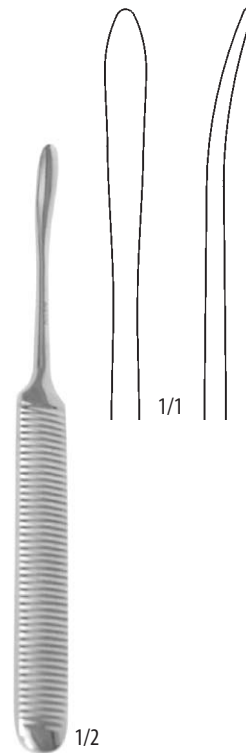

WILLIGER
123 08 0030
16,0 cm

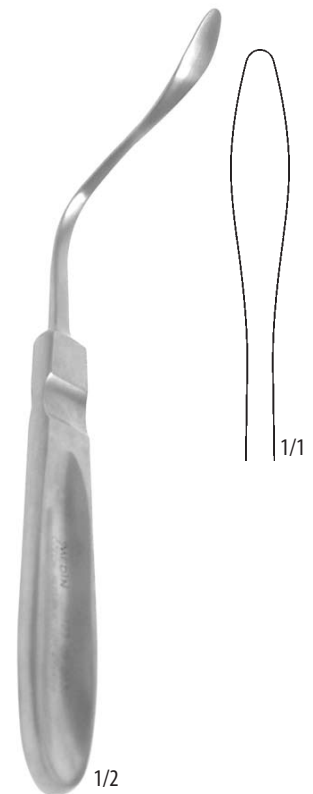

ZAHRADNÍČEK
123 09 0030
21,0 cm

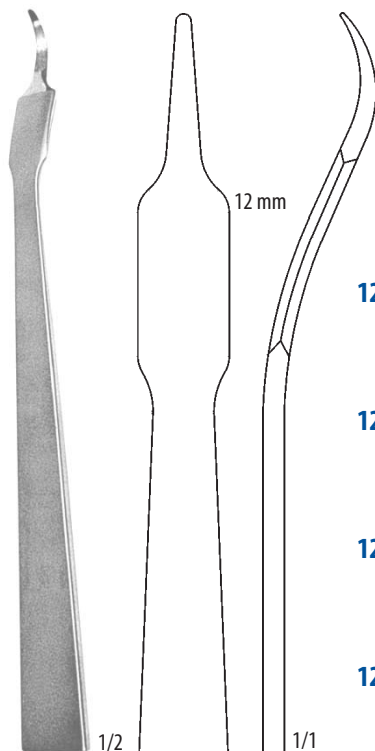

HOHMANN
přímé – straight
123 09 0310
19,6 cm
12 mm

123 09 0300 – Fig. 1
tupé – blunt
14,0 cm

123 09 0310 – Fig. 2
tupé – blunt
19,6 cm

123 09 0320 – Fig. 1
ostré – sharp
14,0 cm

123 09 0330 – Fig. 2
ostré – sharp
19,6 cm

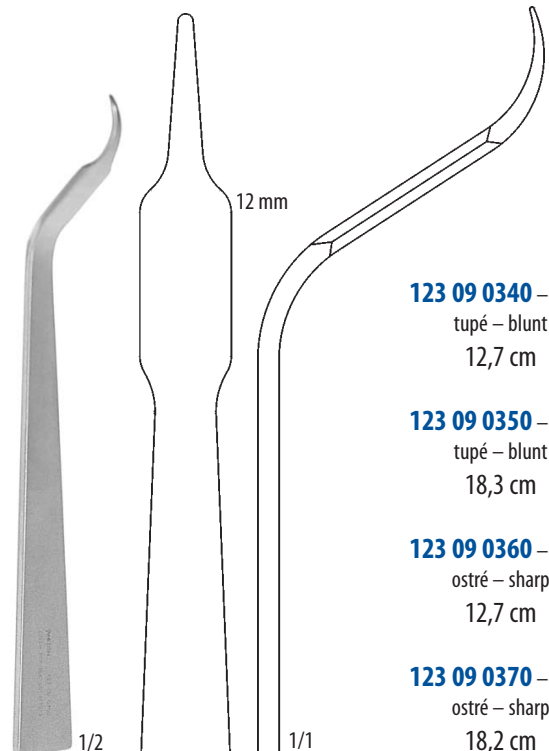

HOHMANN
prohnuté – bent
123 09 0350
18,3 cm
12 mm

123 09 0340 – Fig. 1
tupé – blunt
12,7 cm

123 09 0350 – Fig. 2
tupé – blunt
18,3 cm

123 09 0360 – Fig. 1
ostré – sharp
12,7 cm

123 09 0370 – Fig. 2
ostré – sharp
18,2 cm



1/3

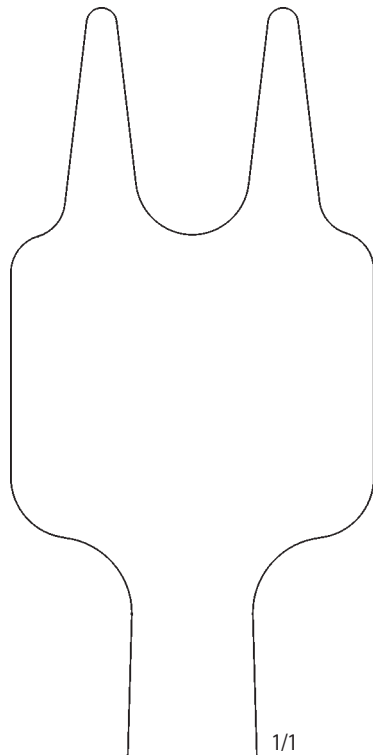

1/1

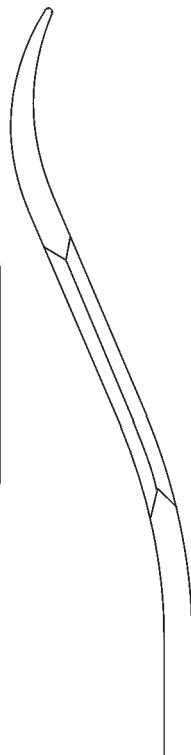

1/1

123 99 0004

přímé – straight

29,5 cm

48 mm



1/3

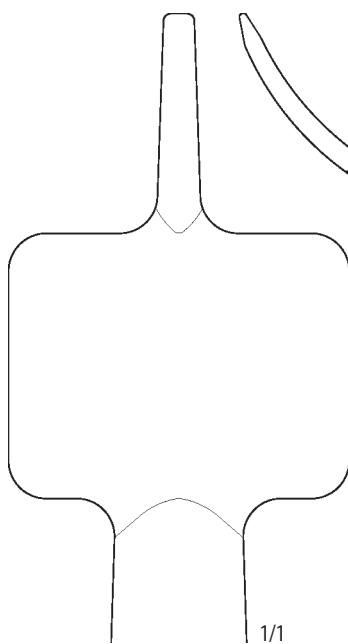

1/1

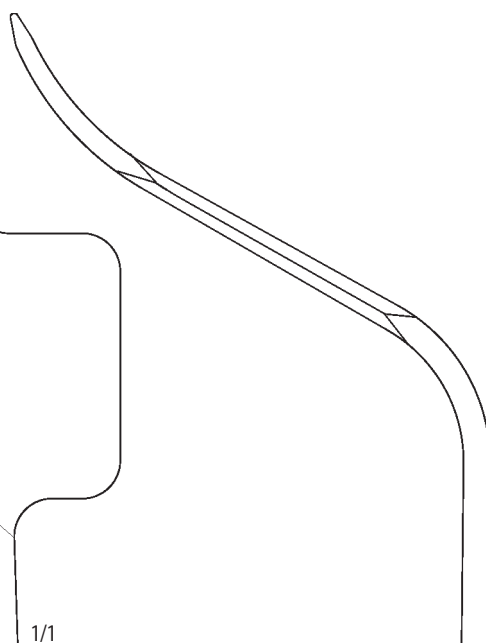

1/1

123 99 0067

široké prohnuté – wide bent

25,0 cm

45 mm

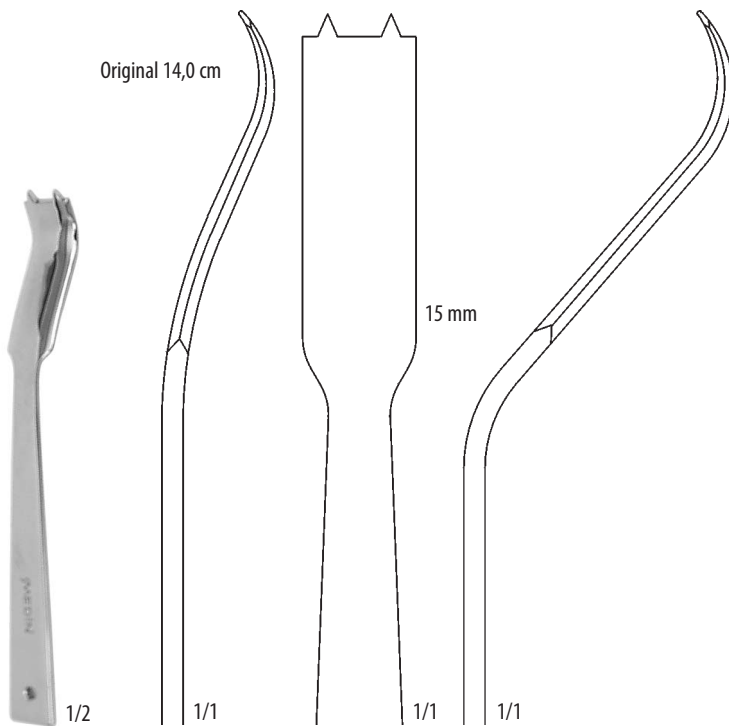

123 99 0006
přímé – straight
14,0 cm
15 mm

123 99 0007
prohnuté – bent
12,7 cm
15 mm

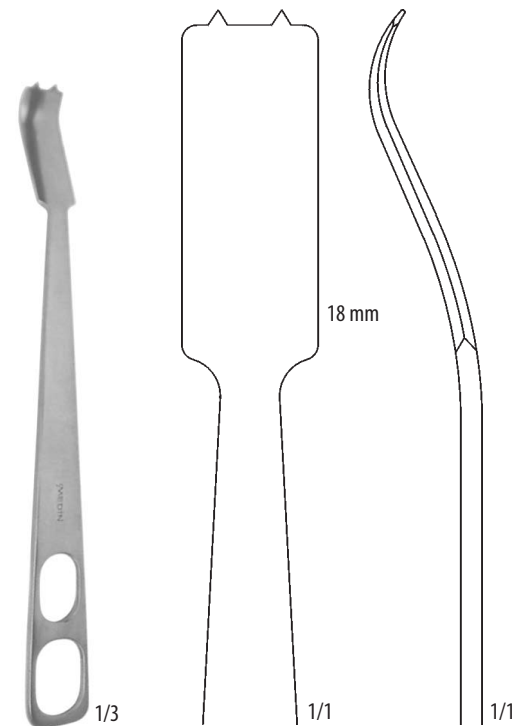

123 99 0016
přímé – straight
25,5 cm
18 mm

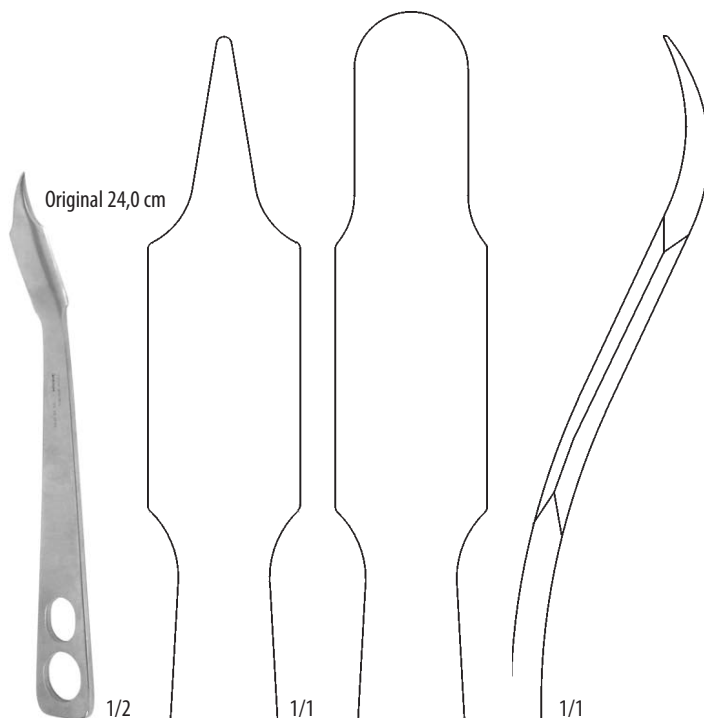

123 99 0033
úzké ostré – narrow sharp
24,0 cm
20 mm

123 99 0060
široké tupé – wide blunt
24,5 cm
20 mm

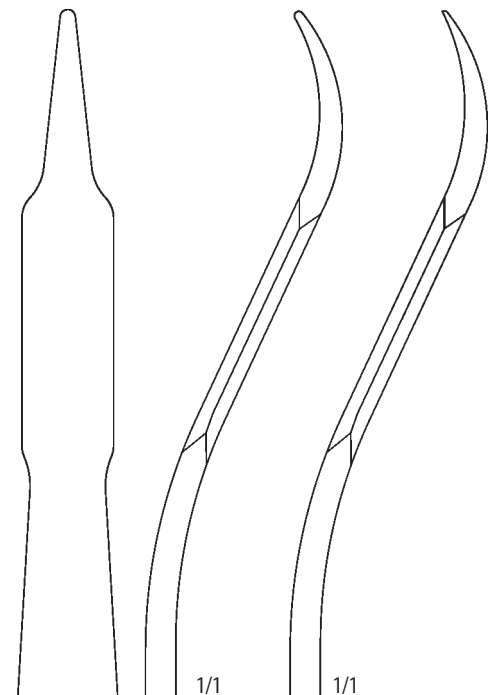

123 99 0101
tupé – blunt
24,0 cm
12 mm

123 99 0102
ostré – sharp
24,0 cm
12 mm

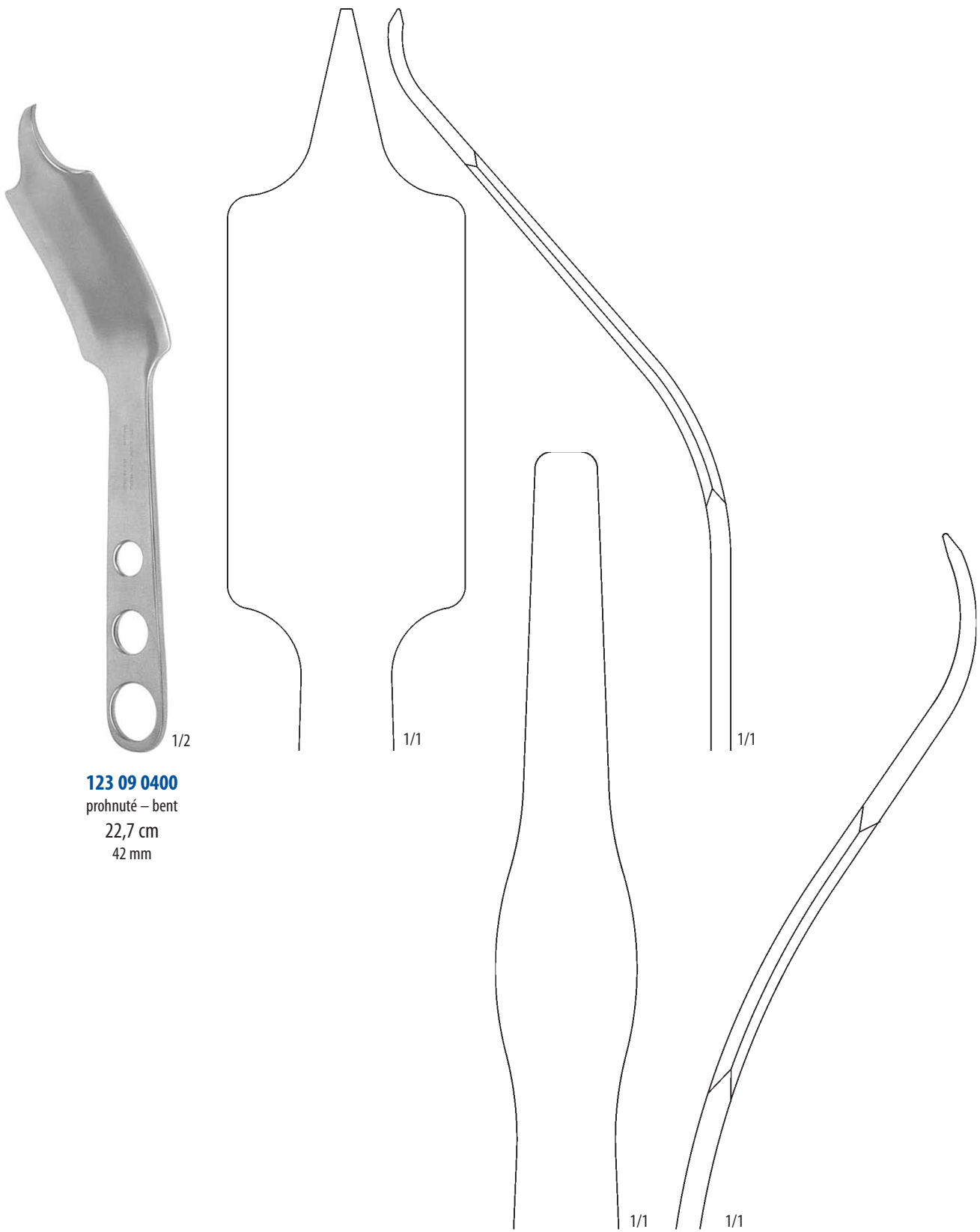
**123 09 0400**

prohnuté – bent

22,7 cm

42 mm

123 99 0097

tupé – blunt

27,7 cm

25 mm

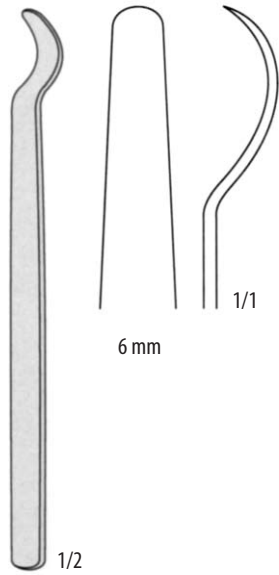

123 91 0030
14,0 cm

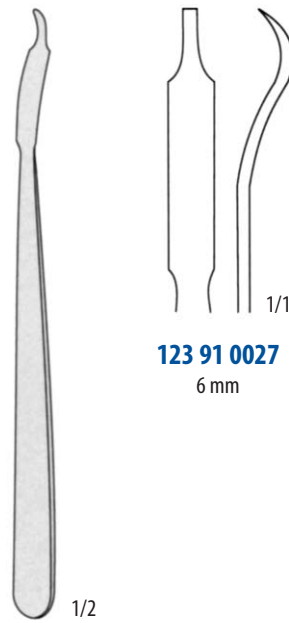

123 91 0027
6 mm

MINI-HOHMANN
16,0 cm



123 91 0028
8 mm

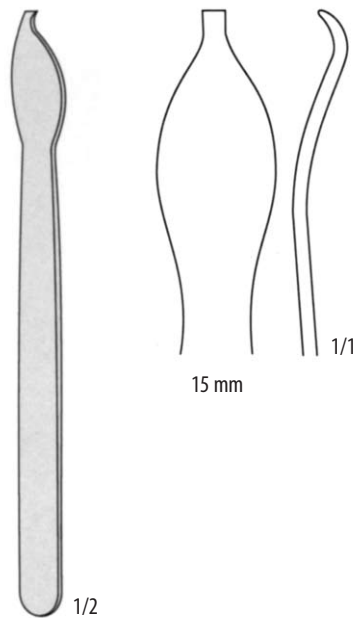

123 91 0031
17,0 cm

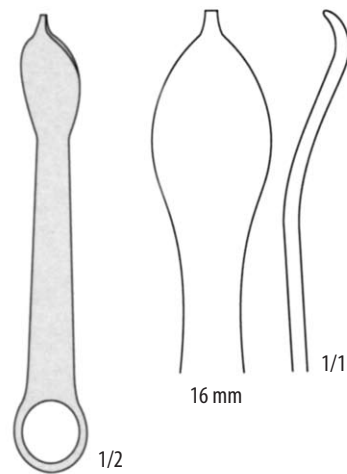

123 91 0032
12,0 cm

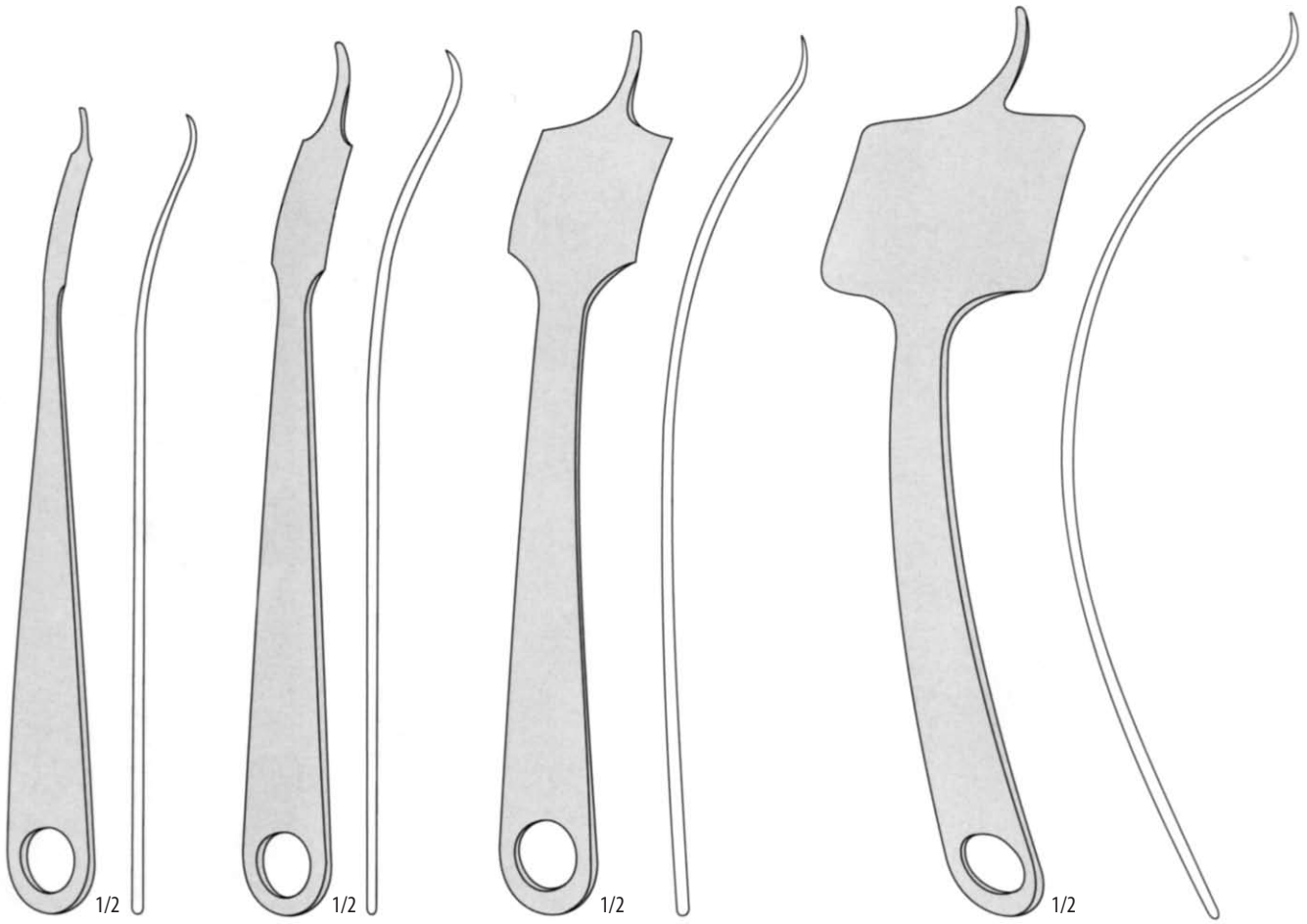

HOHMANN
123 91 0033
22,0 cm
8 mm

HOHMANN
123 91 0034
24,0 cm
18 mm

HOHMANN
123 91 0035
26,0 cm
43 mm

HOHMANN
123 91 0036
29,0 cm
70 mm

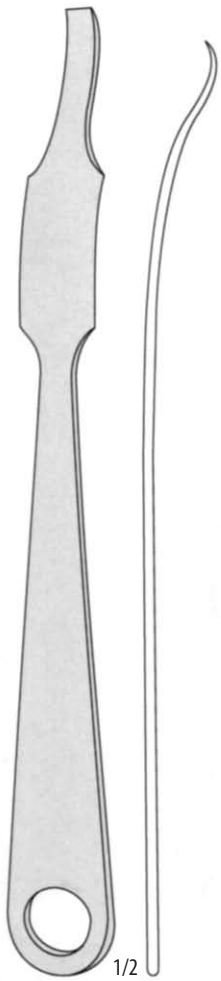

HOHMANN
123 91 0037
25,0 cm
22 mm

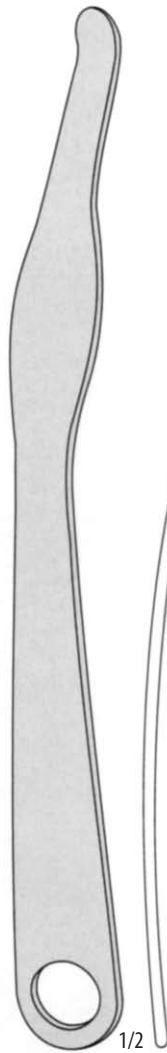

123 91 0026
28,0 cm
24 mm

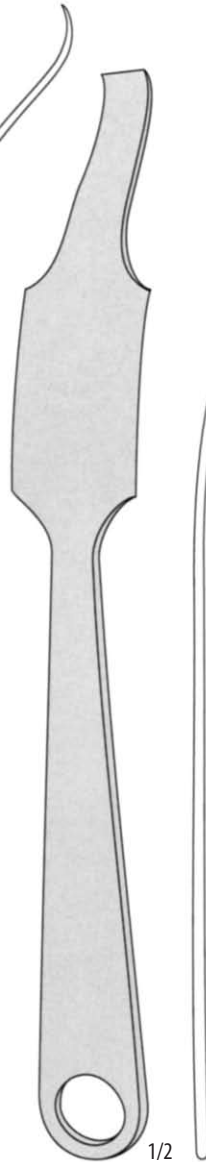

HOHMANN
123 91 0029
29,0 cm
33 mm

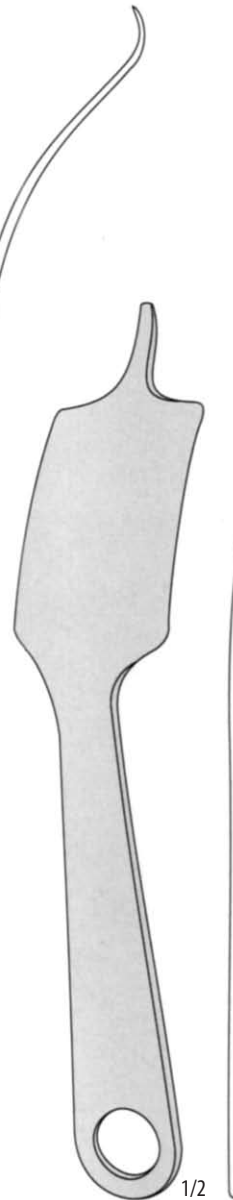

HOHMANN
123 91 0038
25,0 cm
43 mm

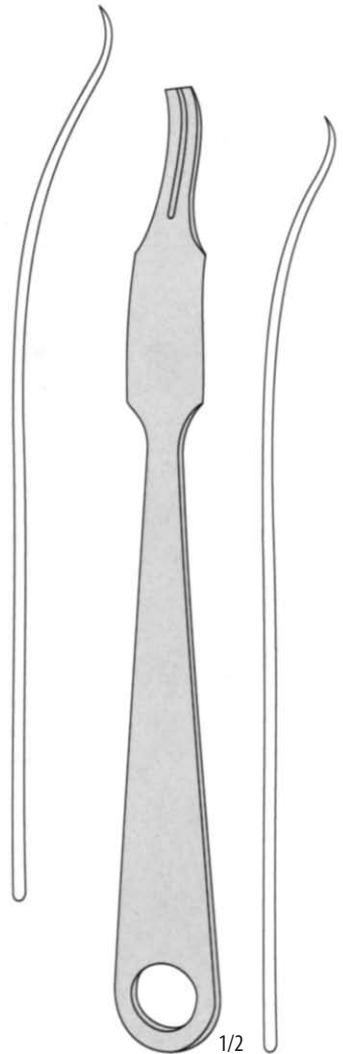

LANGE-HOHMANN
123 91 0039
26,0 cm
22 mm



1/3

BLOUNT
123 91 0040
26,0 cm



1/3

BLOUNT
123 91 0041
26,0 cm

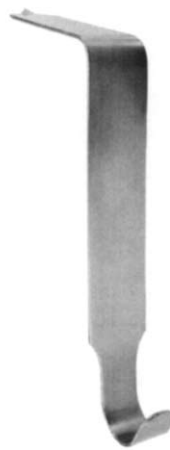

1/3

TAYLOR
16,5 cm

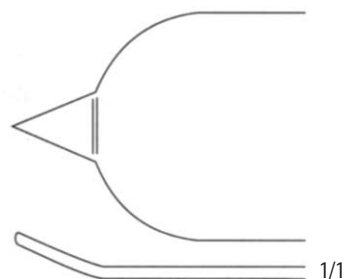

1/1

123 91 0042
75 × 30 mm

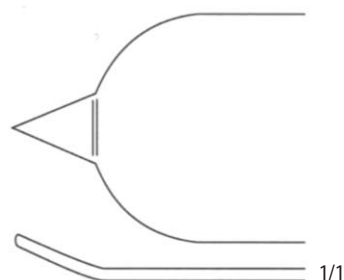

1/1

123 91 0043
100 × 30 mm

UVOLŇOVAČE NEUROCHIRURGICKÉ NEUROSURGICAL ELEVATORS

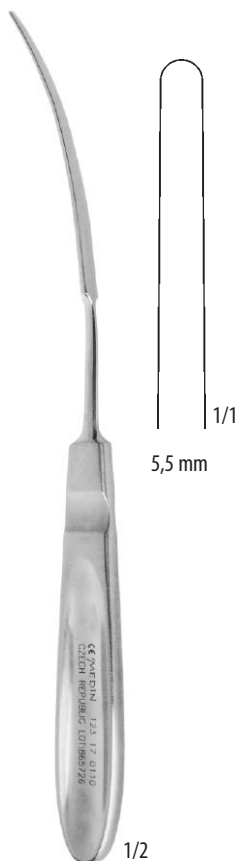

1/1

5,5 mm

1/2

SACHS
123 17 0110
22,5 cm

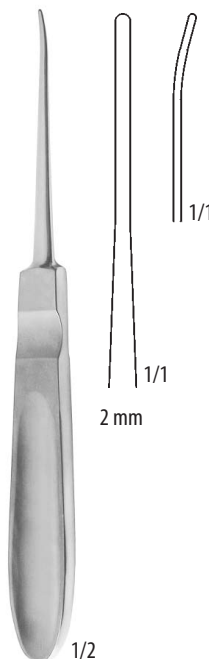

1/1

2 mm

1/2

UVOLŇOVAČ NERVŮ
NERVE ELEVATOR
123 17 0040
17,0 cm

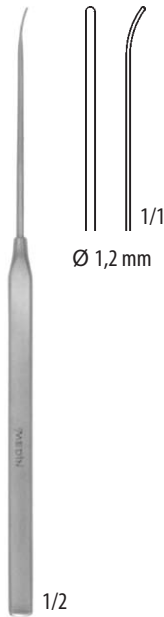

PÁČKA UŠNÍ
EAR ELEVATOR
123 29 0010
16,0 cm



LUCAE
123 29 0020
15,0 cm



LUCAE
123 29 0030
15,0 cm



LUCAE
123 29 0040
15,0 cm

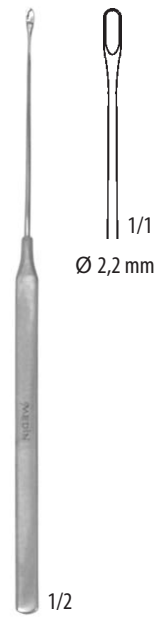

LUCAE
123 29 0080
16,0 cm

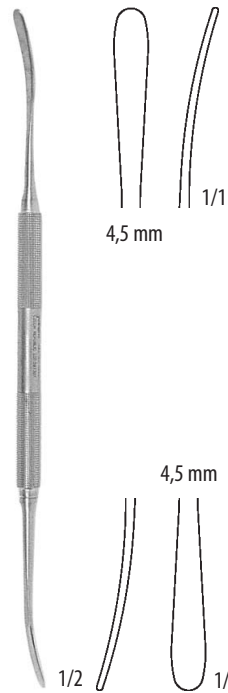

FREER
123 30 0030
17,9 cm

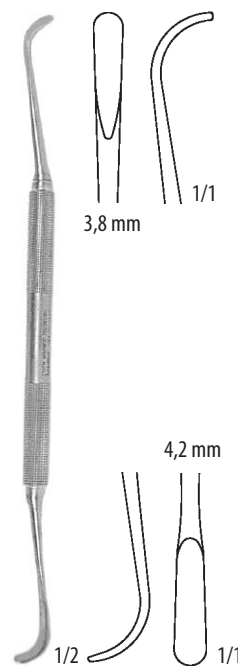

123 99 0084
17,0 cm

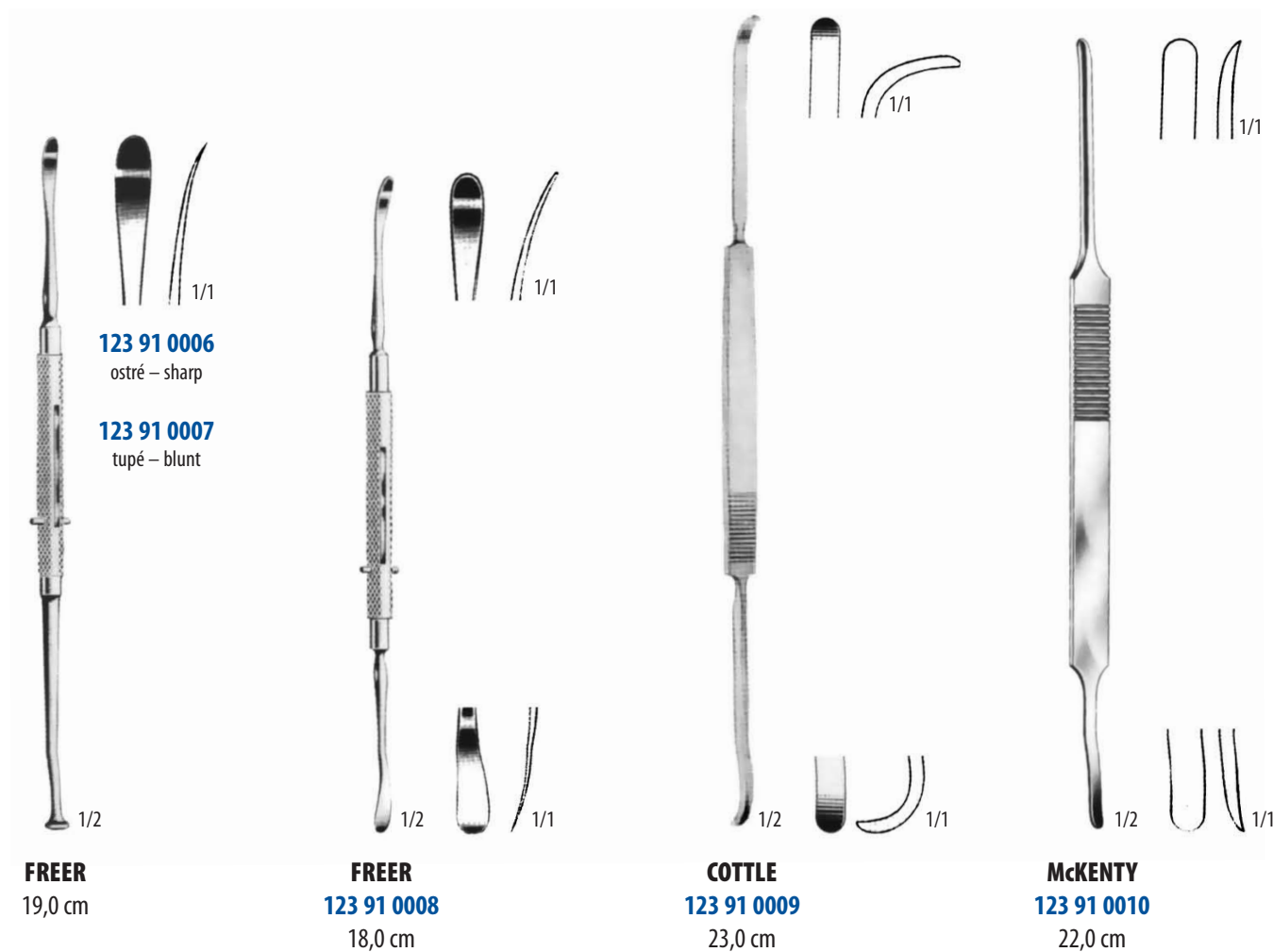

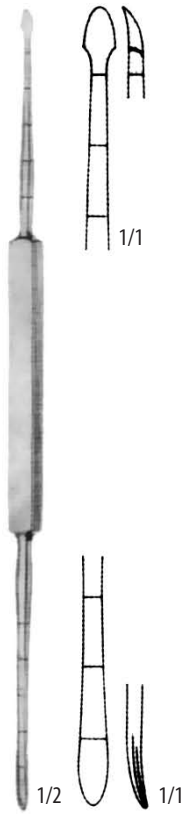

COTTLE
123 91 0011
21,0 cm



MASING
123 91 0012
21,0 cm



HOWARTH
123 91 0013
21,5 cm



KILLIAN
123 91 0014
18,0 cm



KILLIAN
123 91 0015
22,0 cm







Original 16 cm
6 mm

1/2

WILLIGER
16,0 cm

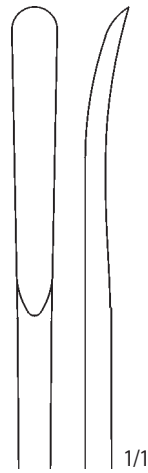

1/1

124 08 0111
16,0 cm
6 mm
matovaná – matt



1/1

124 08 0280
16,0 cm
3,5 mm
matovaná – matt



1/1

124 08 0290
16,0 cm
3,5 mm
matovaná – matt

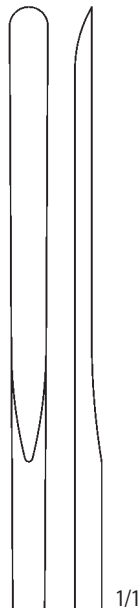

1/1

124 08 0250
18,0 cm
5 mm
matovaná – matt



1/2

LANGENBECK
124 08 0120
20,5 cm

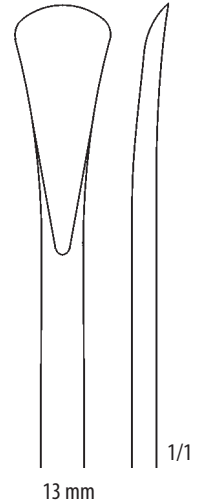

1/1

13 mm

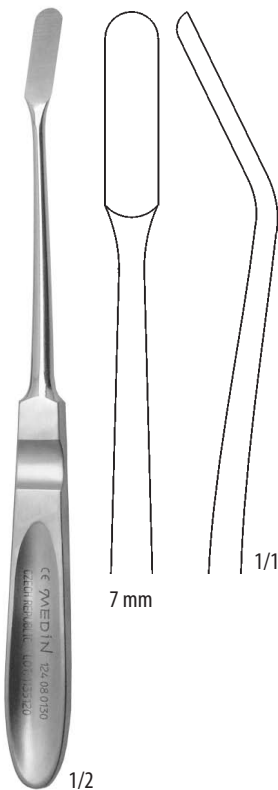

7 mm

1/1

LANGENBECK
124 08 0130
20,4 cm

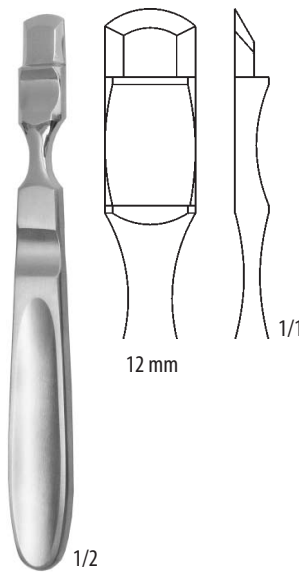

12 mm

1/1

FARABEUF
124 08 0170
rovná – straight
14,5 cm

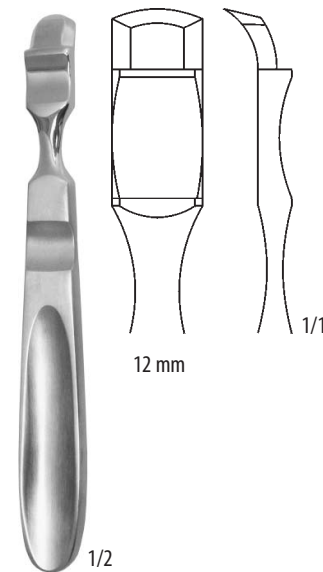

12 mm

1/1

FARABEUF
124 08 0180
zahnutá – curved
14,5 cm



1/2

DOYEN
124 10 0101
levá – left
15,0 cm



1/2

DOYEN
124 10 0111
pravá – right
15,0 cm

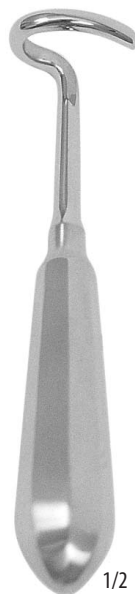

1/2

DOYEN
124 14 0191
levá – left
15,5 cm



1/2

DOYEN
124 14 0181
pravá – right
15,5 cm



1/2

124 14 0020
21,6 cm

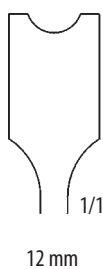

1/1

12 mm



1/1



1/2

124 14 0021
22,1 cm



1/2

124 14 0030
20,8 cm

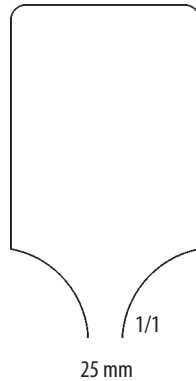

1/1

25 mm



1/1



1/2

124 14 0031
21,3 cm

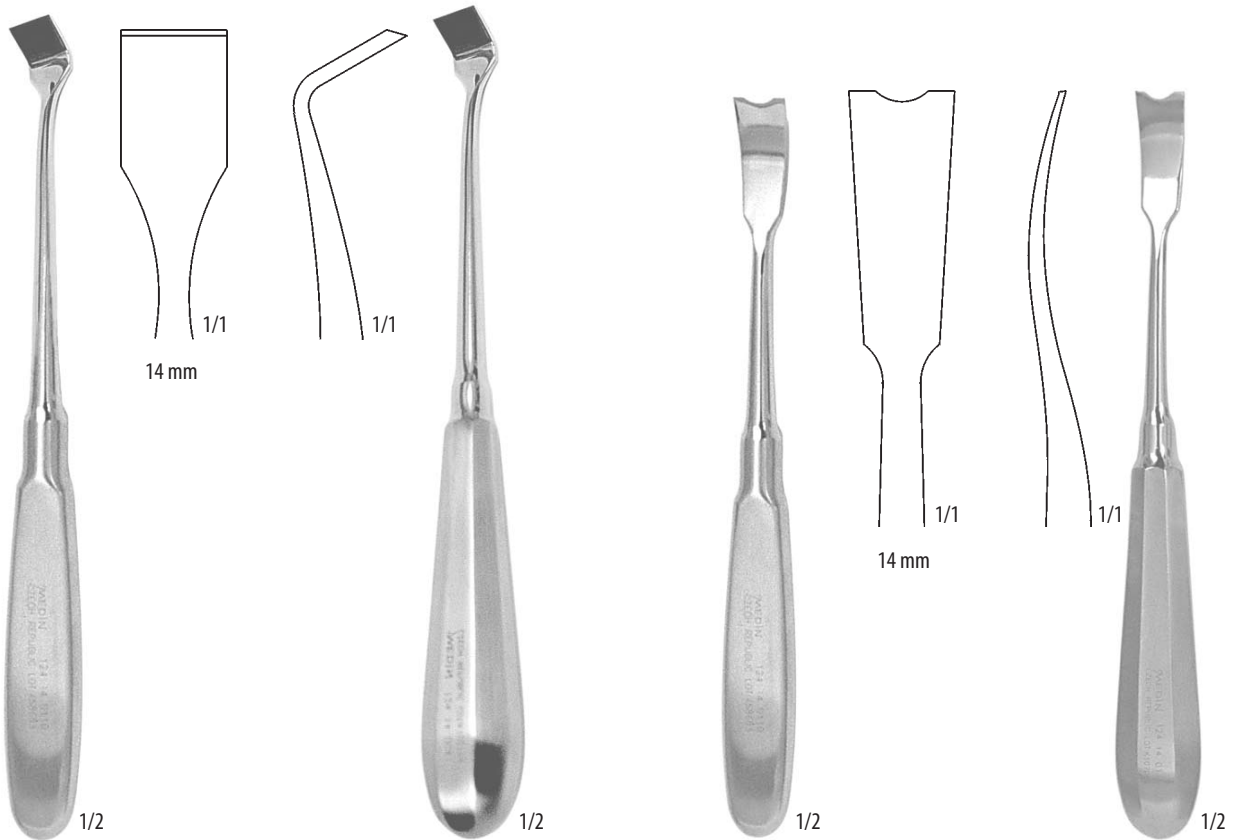
OLLIER
124 14 0050 – 124 14 0070
OLLIER
124 14 0051 – 124 14 0071

SAUERBRUCH
124 14 0040

21,6 cm

SAUERBRUCH
124 14 0041

22,1 cm

OLLIER
124 14 0110

19,3 cm

OLLIER
124 14 0111

19,8 cm

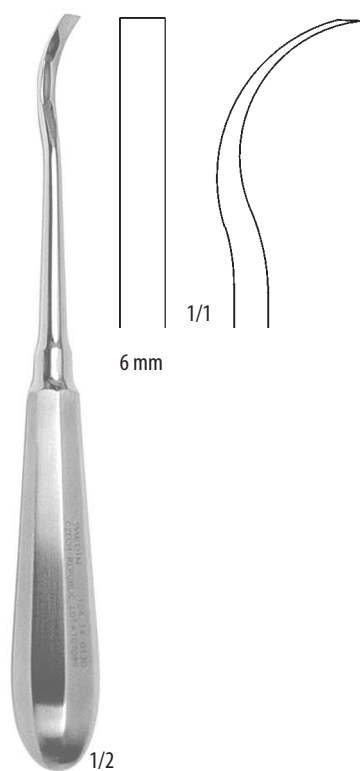

124 14 0130
20,0 cm

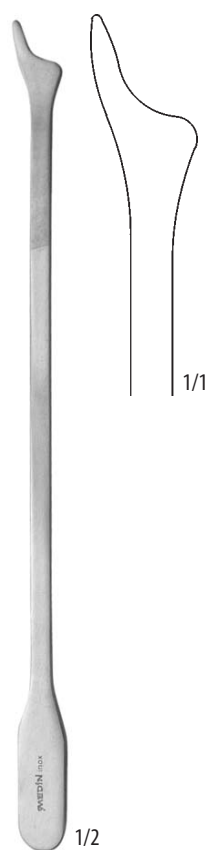

AYER
124 27 0011
22,0 cm

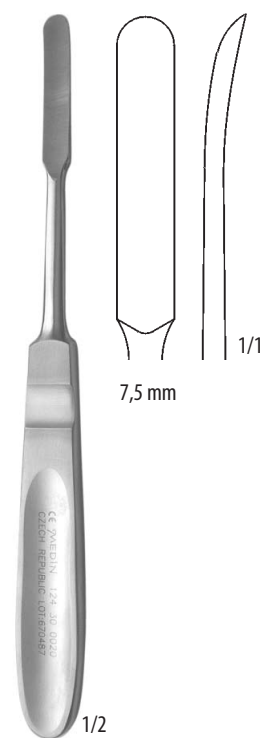

PŘECEHTĚL
124 30 0020
19,0 cm

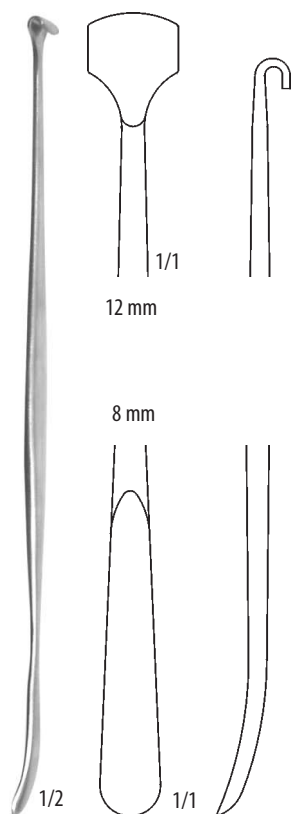

HURD
124 32 0010
21,0 cm



ŠKRABKA NA ROHOVKU
CORNEAL SCARIFIER
124 38 0010
12,5 cm



ŠKRABKA NA ROHOVKU
CORNEAL SCARIFIER
124 38 0070
12,5 cm

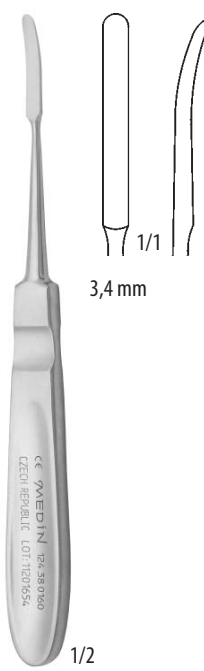

124 38 0160
17,2 cm

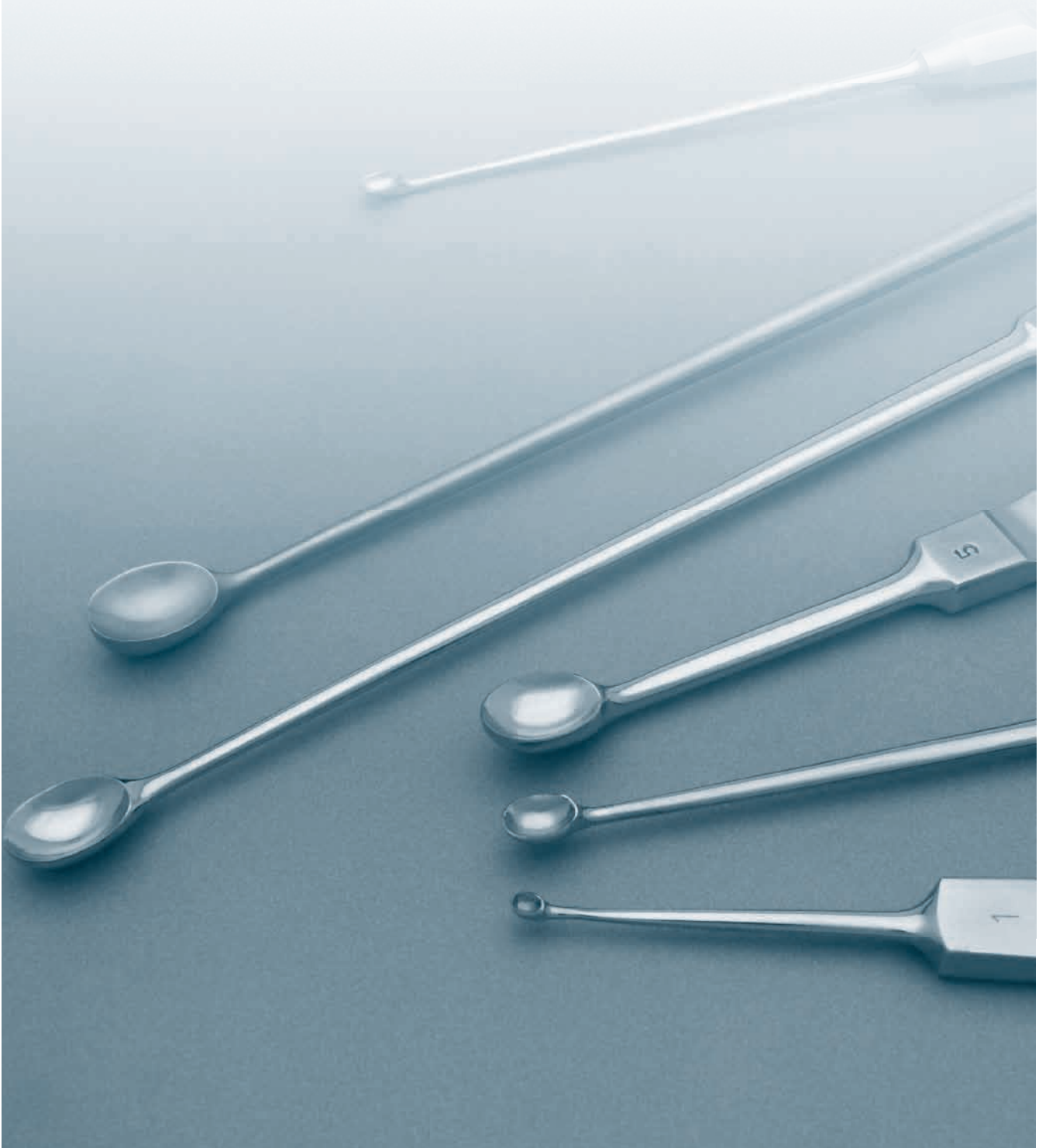



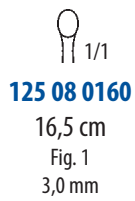
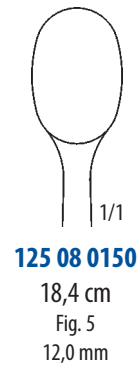
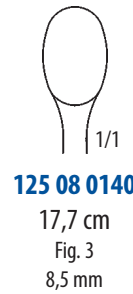
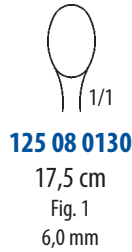
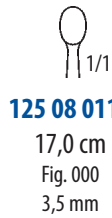



LUER-KOERTE
32,0 cm

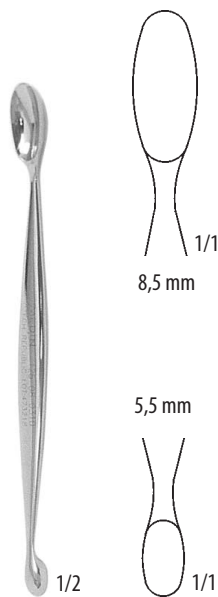

VOLKMANN
125 08 0310
13,5 cm

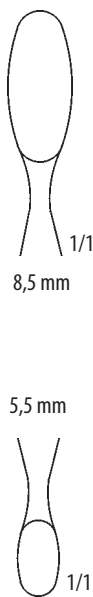

125 91 0148
fig. 000
2,5 mm



125 91 0149
fig. 00
3,2 mm

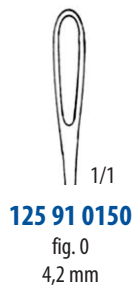

125 91 0150
fig. 0
4,2 mm

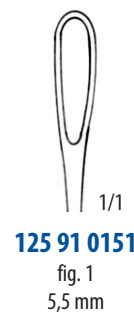

125 91 0151
fig. 1
5,5 mm

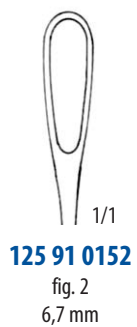

125 91 0152
fig. 2
6,7 mm

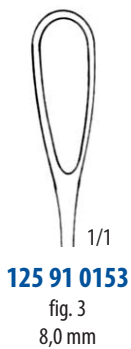

125 91 0153
fig. 3
8,0 mm

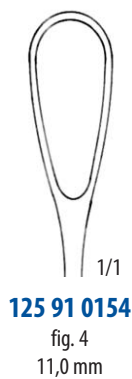

125 91 0154
fig. 4
11,0 mm



125 91 0155
fig. 5
15,0 mm



125 27 0050
30,0 cm



125 27 0060
30,0 cm



RECAMIER
125 27 0120
31,0 cm



125 27 0070
Fig. 1
6,8 mm



125 27 0080
Fig. 2
8,5 mm



125 27 0090
Fig. 3
10 mm



125 27 0100
Fig. 4
11,5 mm



125 27 0110
Fig. 5
13 mm

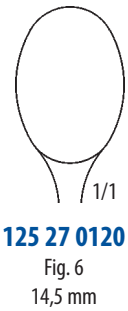

125 27 0120
Fig. 6
14,5 mm



HALLE
125 30 0100
23,0 cm

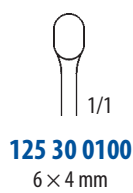

125 30 0100
6 × 4 mm

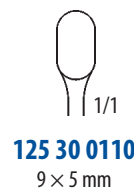

125 30 0110
9 × 5 mm



1/2

MEYHÖFER
125 38 0040
13,0 cm



125 38 0010
Ø 1,6 mm



125 38 0020
Ø 2,2 mm



125 38 0030
Ø 2,8 mm



125 38 0040
Ø 3,4 mm



125 38 0050
Ø 4 mm



1/2

BUNGE
125 38 0170
16,0 cm

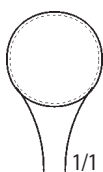

1/1
Ø 15 mm

Ø 12,5 mm



1/1



1/2

DAVIEL
125 38 0360
13,3 cm
Fig. 1

2/1
1 mm
1,6 mm



2/1



1/2

DAVIEL
125 38 0370
13,3 cm
Fig. 2

2/1
1 mm
2,2 mm



2/1



1/2

LANG
125 38 0530
15,0 cm



2/1
Ø 3,5 mm

Ø 4,5 mm



2/1



1/2

KUNC
125 17 0170
21,5 cm



1/1

125 17 0120
21,5 cm
2 × 4 mm



1/1

125 17 0130
21,5 cm
3 × 4 mm



1/1

125 17 0140
21,5 cm
4 × 8 mm

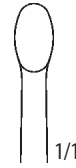

1/1

125 17 0150
21,5 cm
5 × 9 mm

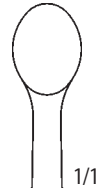

1/1

125 17 0160
21,5 cm
9 × 12 mm

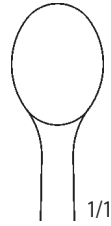

1/1

125 17 0170
21,5 cm
12 × 16 mm



1/3

125 17 0250
oválná – elliptical
30,0 cm

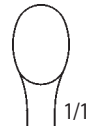

1/1

125 17 0250
7 × 10 mm



1/1

125 17 0260
9 × 12 mm



1/1

125 17 0270
12 × 18 mm



1/2

CLOWARD
125 17 0300
23,0 cm

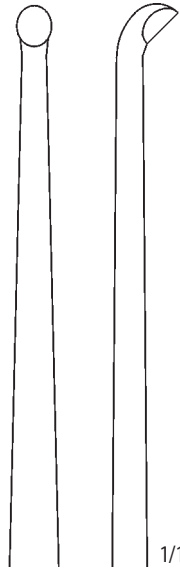

1/1

přímá – straight
4 mm

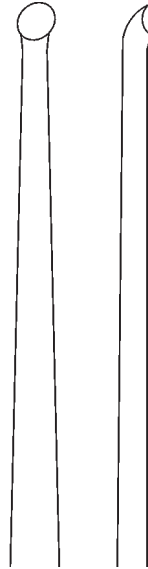

1/1

125 17 0310
23,0 cm
vyhnutá, vpravo – curved, right
4,8 × 5,5 mm



1/2

CLOWARD

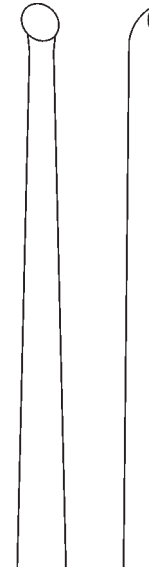

1/1

125 17 0320
23,0 cm
vyhnutá, vlevo – curved, left
4,8 × 5,5 mm



125 17 0410
rovná – straight
32,5 cm
13,5 × 19 mm

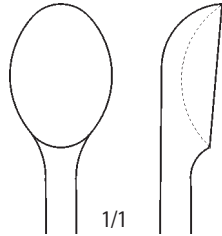

125 17 0410
rovná – straight
32,5 cm
13,5 × 19 mm

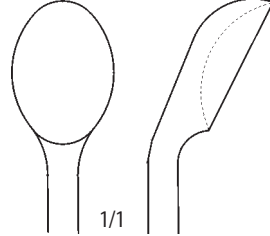

125 17 0420
zahnutá – curved
32,5 cm
13,5 × 19 mm

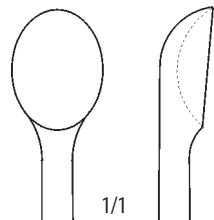

125 17 0430
rovná – straight
32,5 cm
12 × 16 mm

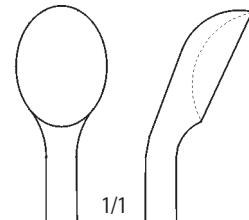

125 17 0440
zahnutá – curved
32,5 cm
12 × 16 mm

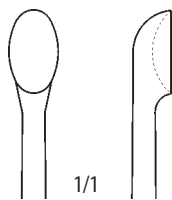

125 17 0450
rovná – straight
32,5 cm
8,5 × 11 mm

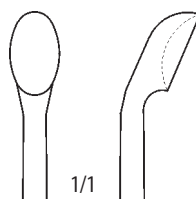

125 17 0460
zahnutá – curved
32,5 cm
8,5 × 11 mm



125 09 0010
35,0 cm
14,5 × 23,7 mm

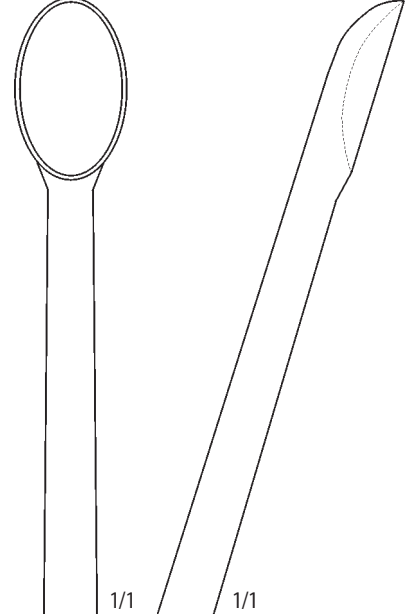

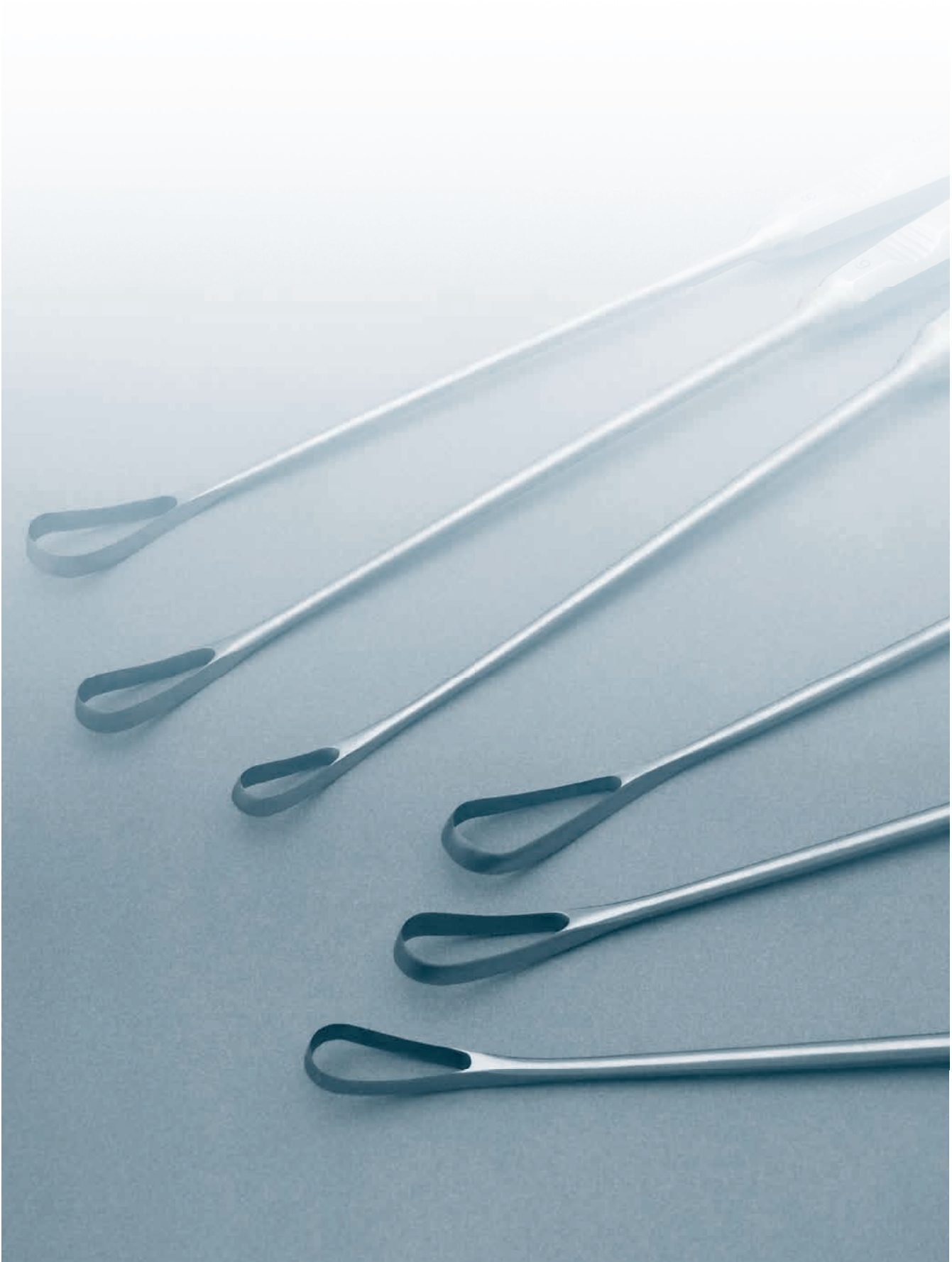





1/3

126 27 0010
29,0 cm

1/1

126 27 0010

Fig. 1



1/1

126 27 0020

Fig. 2



1/1

126 27 0030

Fig. 3

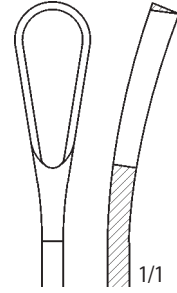

1/1

126 27 0040

Fig. 4



1/1

126 27 0050

Fig. 5



1/1

126 27 0060

Fig. 6



1/1

126 27 0070

Fig. 7

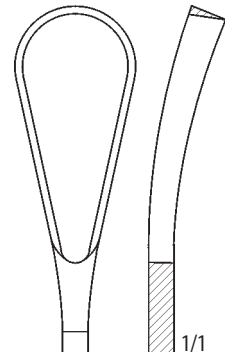

1/1

126 27 0080

Fig. 8



1/3

126 27 0011
29,0 cm

1/1

126 27 0011

Fig. 1



1/1

126 27 0021

Fig. 2



1/1

126 27 0031

Fig. 3

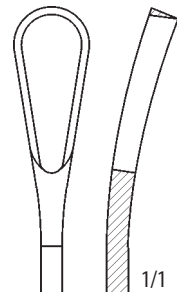

1/1

126 27 0041

Fig. 4



1/1

126 27 0051

Fig. 5



1/1

126 27 0061

Fig. 6



1/1

126 27 0071

Fig. 7

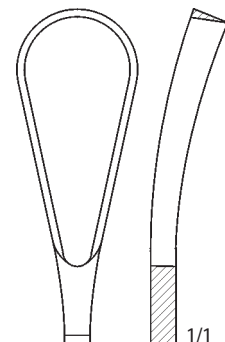

1/1

126 27 0081

Fig. 8

KYRETY DĚLOŽNÍ OSTRÉ
UTERINE CURETTES SHARP

126 27 0012
 29,0 cm

126 27 0012
 Fig. 1

126 27 0022
 Fig. 2

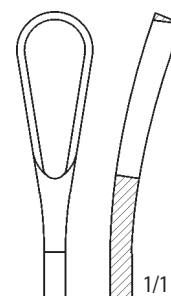
126 27 0032
 Fig. 3

126 27 0042
 Fig. 4

126 27 0052
 Fig. 5

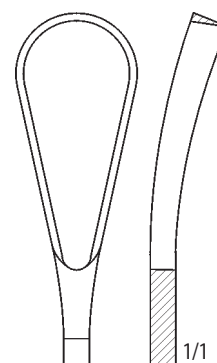
126 27 0062
 Fig. 6

126 27 0072
 Fig. 7

126 27 0082
 Fig. 8

KYRETY DĚLOŽNÍ TUPÉ
UTERINE CURETTES BLUNT

126 27 0110
 29,0 cm

126 27 0110
 Fig. 1

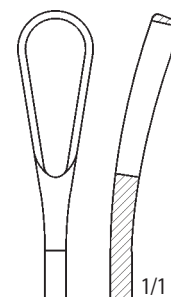
126 27 0120
 Fig. 2

126 27 0130
 Fig. 3

126 27 0140
 Fig. 4

126 27 0150
 Fig. 5

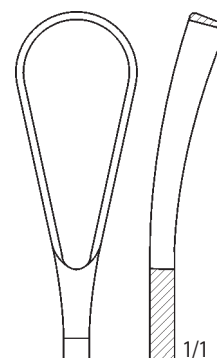
126 27 0160
 Fig. 6

126 27 0170
 Fig. 7

126 27 0180
 Fig. 8



126 27 0111
29,0 cm



126 27 0111
Fig. 1



126 27 0121
Fig. 2



126 27 0131
Fig. 3

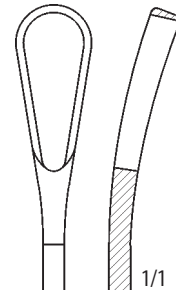

126 27 0141
Fig. 4



126 27 0151
Fig. 5



126 27 0161
Fig. 6



126 27 0171
Fig. 7

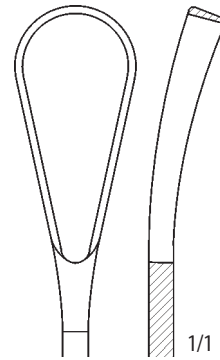

126 27 0181
Fig. 8



126 27 0112
29,0 cm



126 27 0112
Fig. 1



126 27 0122
Fig. 2



126 27 0132
Fig. 3

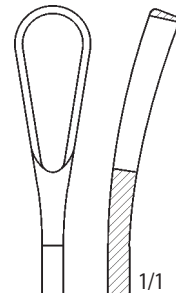

126 27 0142
Fig. 4



126 27 0152
Fig. 5



126 27 0162
Fig. 6



126 27 0172
Fig. 7

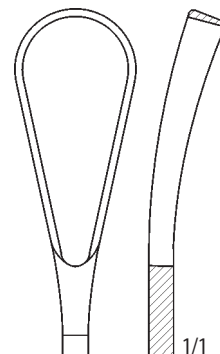

126 27 0182
Fig. 8



BRUENINGS
126 91 0001
28,0 cm



126 32 0080
4,8 cm
Ø 0,3 mm



126 32 0090
4,8 cm
Ø 0,4 mm



126 32 0110
4,8 cm
Ø 0,5 mm



126 32 0120
4,0 cm
Ø 0,3 mm



126 32 0130
4,0 cm
Ø 0,4 mm



126 32 0140
4,0 cm
Ø 0,5 mm



126 32 0160
4,5 cm
Ø 0,4 mm

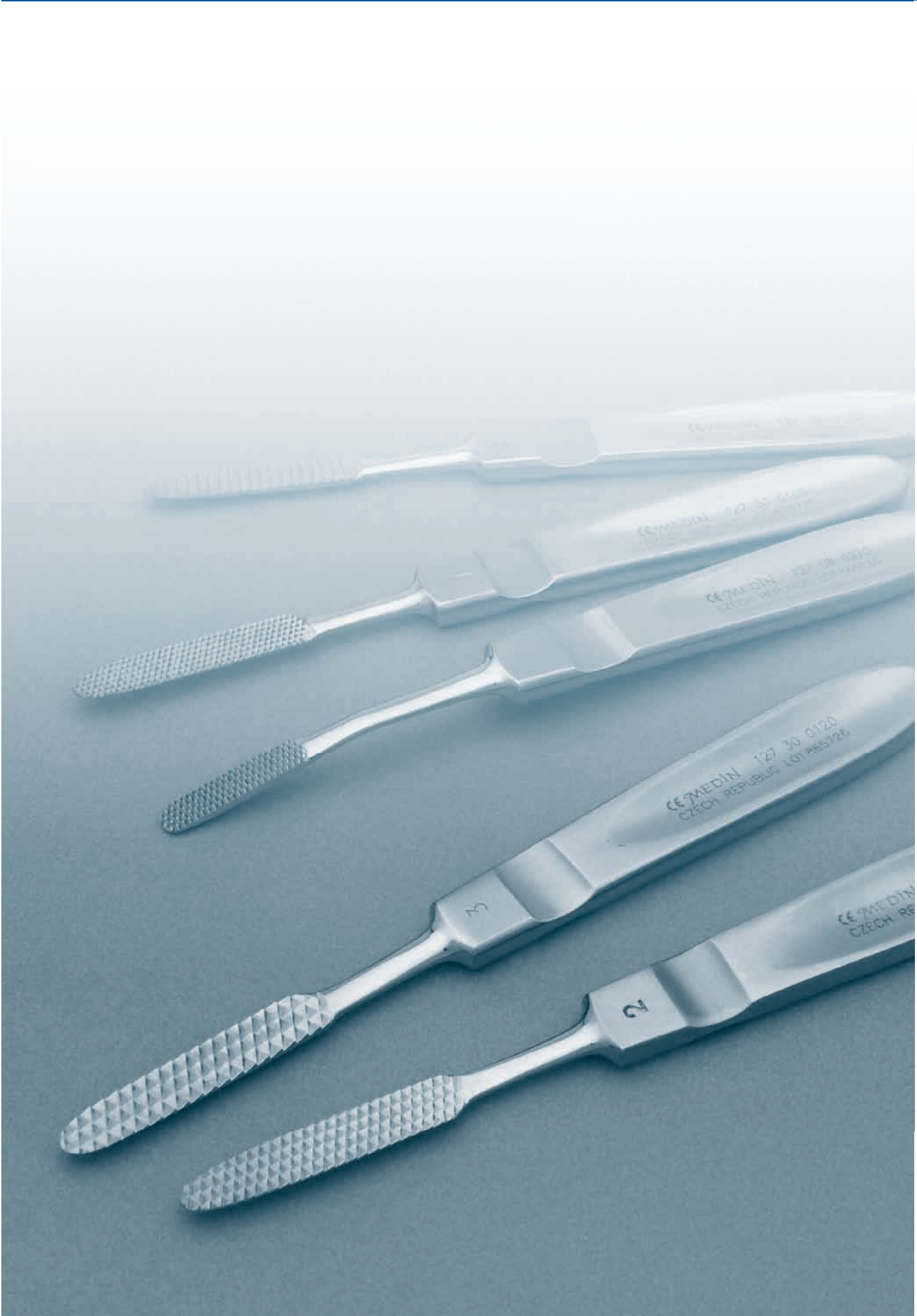





1/2

WIGMORE
127 91 0001
19,0 cm



1/2

ENGEL
127 91 0002
14,0 cm

 PILKA ELEKTRICKÁ NA SÁDROVÉ OBVAZY
DRESSING ELECTRICAL SAW

127 91 0003 = 220 V (+ **127 91 0005** + **127 91 0006** + **127 91 0007**)

127 91 0004 = 110 V (+ **127 91 0005** + **127 91 0006** + **127 91 0007**)

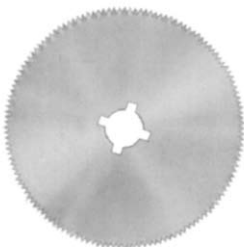

127 91 0005

na tvrdou sádro – for hard plaster
Ø 5,0 cm

127 91 0006

na tvrdou sádro – for hard plaster
Ø 6,5 cm

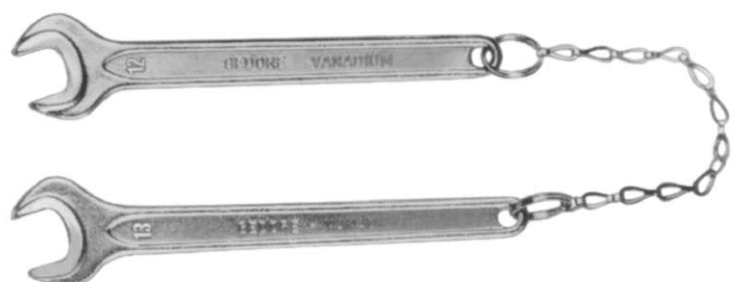

127 91 0007

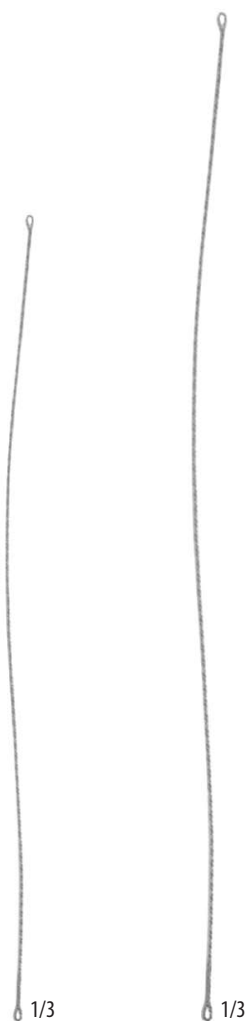

OLIVECRONE
127 17 0011
32,0 cm

OLIVECRONE
127 17 0021
40,0 cm



GUTSCH
127 08 0030
31,5 cm



127 08 0040
26,5 cm
10 zubů na 1"



127 08 0050
26,5 cm
14 zubů na 1"



127 08 0060
26,5 cm
18 zubů na 1"



DRŽÁTKO DRÁTĚNÝCH PILEK
HOO HANDLE FOR SAWS
pár – couple
127 17 0051
8,0 cm



ZAVADĚČ DRÁTĚNÝCH PILEK
CONDUCTOR FOR WIRE SAWS
133 17 0061
33,0 cm
133 17 0070
25,0 cm

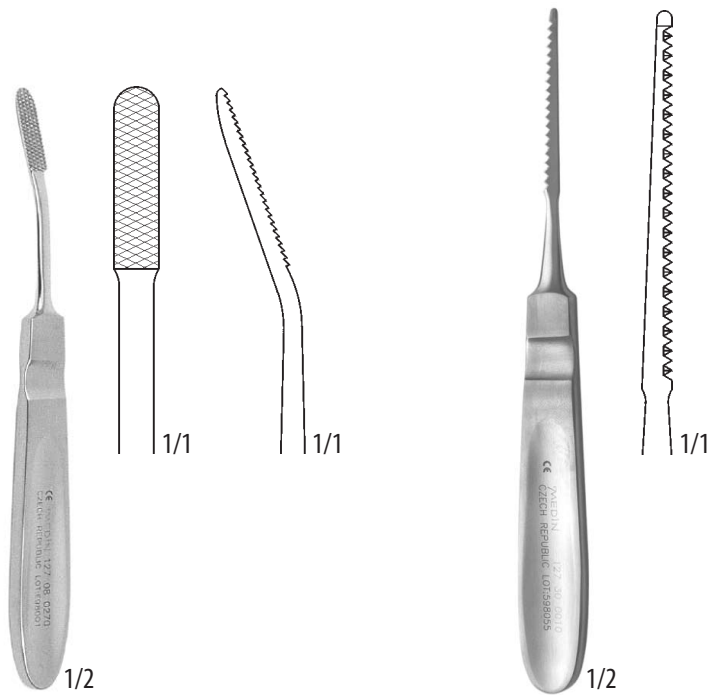

PILNÍK
RASP
127 08 0270
15,9 cm

HOLBROOCK-CURTIS
127 30 0010
18,0 cm

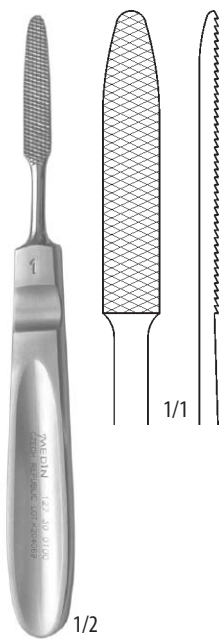

JOSEPH
127 30 0100
16,5 cm
Fig. 1

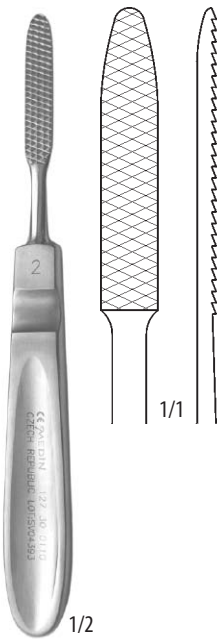

JOSEPH
127 30 0110
16,5 cm
Fig. 2

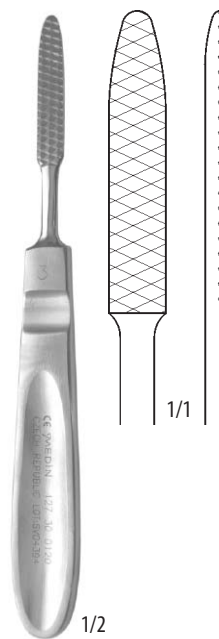

JOSEPH
127 30 0120
16,5 cm
Fig. 3

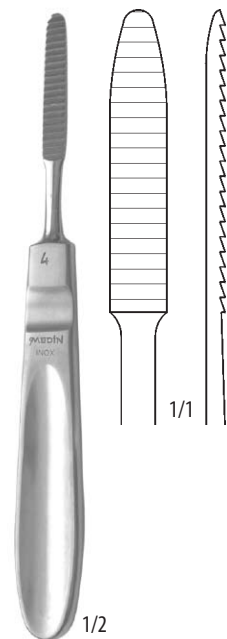

JOSEPH
127 30 0130
16,5 cm
Fig. 4



1/2

127 91 0052
22,0 cm



1/2

127 91 0053
24,5 cm



1/2

127 91 0054
28,0 cm



1/2

PUTTI
127 91 0055
27,0 cm



1/2

PUTTI
127 91 0056
30,0 cm







128 01 0030
14,5 cm



STACKE
128 29 0750
15,0 cm



LEBSCHE
128 91 0214
25,0 cm



128 08 0901
22,0 cm
250 g



128 08 0911
23,5 cm
500 g



128 08 0921
23,5 cm
700 g



128 01 0050
24,5 cm

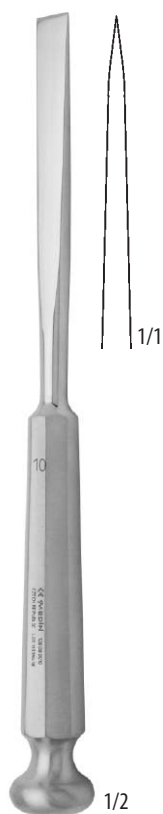

STILLE
128 08 0010
21,0 cm
10,0 mm



STILLE
128 08 0030
21,0 cm
15,0 mm



STILLE
128 08 0040
21,0 cm
20,0 mm



STILLE
128 08 0050
21,0 cm
25,0 mm



STILLE
128 08 1050
21,0 cm
6,0 mm



STILLE
128 08 0160
21,0 cm
15 × 4 mm



STILLE
128 08 0170
21,0 cm
15 × 6 mm



STILLE
128 08 0180
21,0 cm
15 × 8 mm

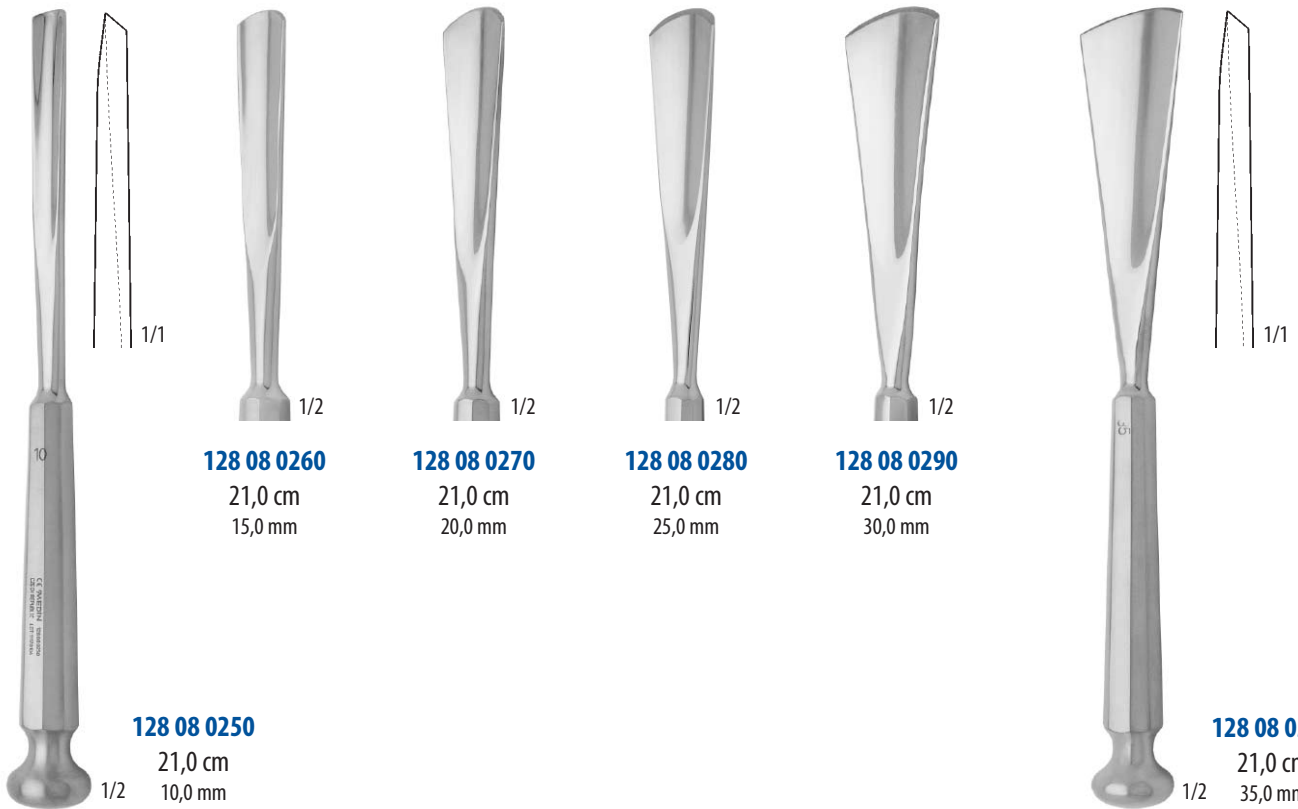

DLÁTA NA NOSNÍ PLASTIKU
NASAL PLASTIC CHISELS

128 12 0100
19,0 cm
Fig. 1



128 12 0110
19,0 cm
Fig. 1



128 12 0120
rovné – straight
19,0 cm

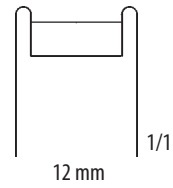

128 12 0130
rovné – straight
19,0 cm

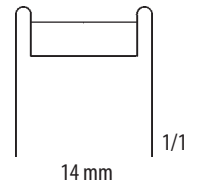

128 12 0140
rovné – straight
19,0 cm

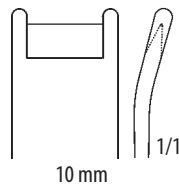

128 12 0270
vyhnuté – curved
19,0 cm

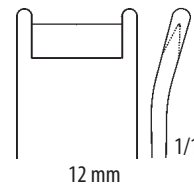

128 12 0280
vyhnuté – curved
19,0 cm

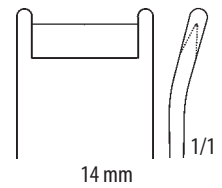

128 12 0290
vyhnuté – curved
19,0 cm

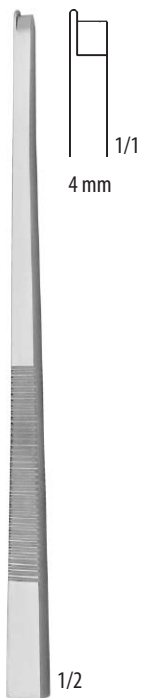

128 12 0160
18,0 cm
Fig. 2



128 12 0170
18,0 cm
Fig. 2



128 12 0180
18,0 cm
Fig. 2

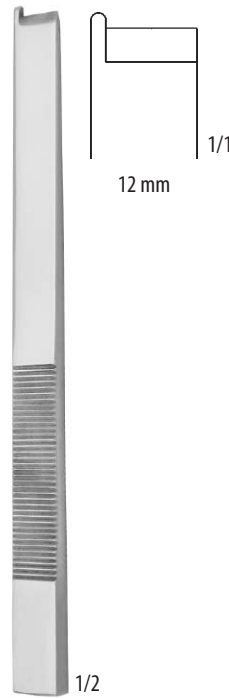

128 12 0190
18,0 cm
Fig. 2

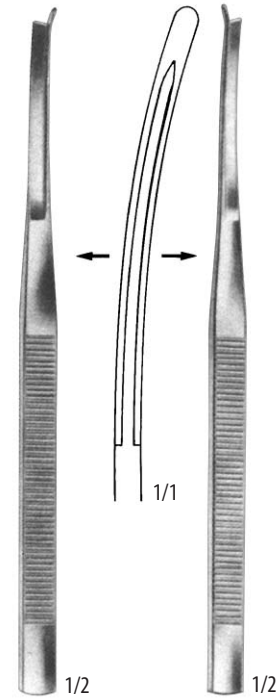

SILVER
128 91 0202
18,0 cm



SILVER
128 91 0203
18,0 cm

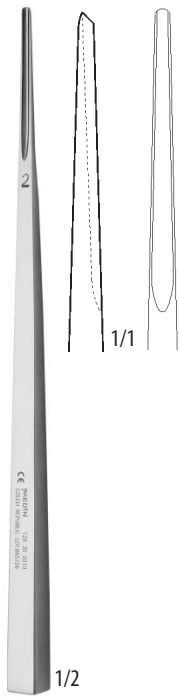

128 30 0010
 18,0 cm
 2 mm

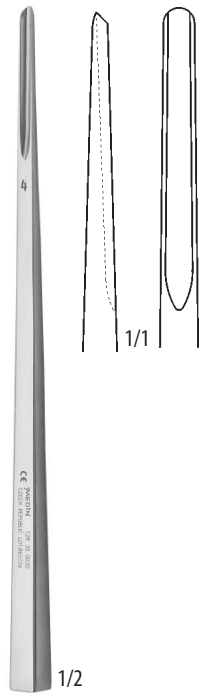

128 30 0030
 18,0 cm
 4 mm

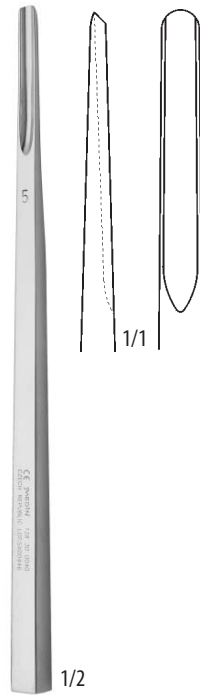

128 30 0040
 18,0 cm
 5 mm

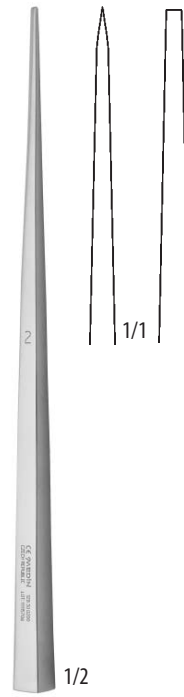

WEST
128 30 0200
 18,0 cm
 2 mm

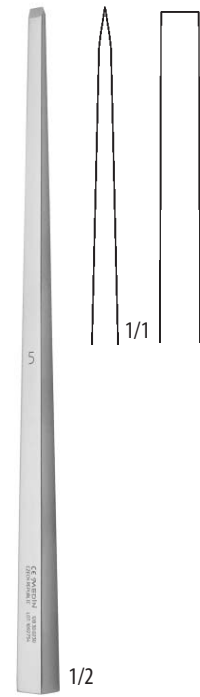

WEST
128 30 0230
 18,0 cm
 5 mm



STACKE
128 29 0410
 14,0 cm
 4 mm



STACKE
128 29 0420
 14,0 cm
 6 mm



STACKE
128 29 0430
 14,0 cm
 8 mm

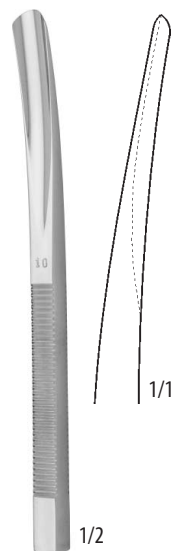

STACKE
128 29 0440
 14,0 cm
 10 mm



STACKE
128 29 0510
 14,0 cm
 4 mm



STACKE
128 29 0520
 14,0 cm
 6 mm



STACKE
128 29 0530
 14,0 cm
 8 mm

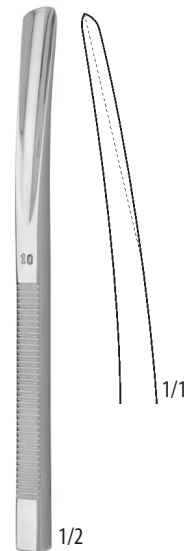

STACKE
128 29 0540
 14,0 cm
 10 mm

DLÁTA NEUROCHIRURGICKÁ LISTOVÁ
NEUROSURGICAL OSTEOTOMES LEAF

Original 40 mm



1/2

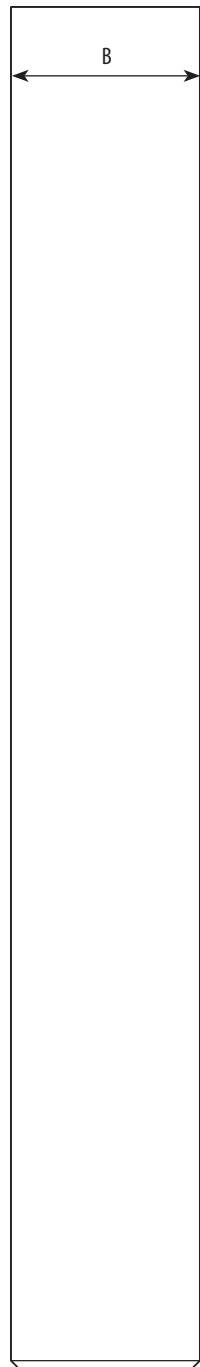

1/1

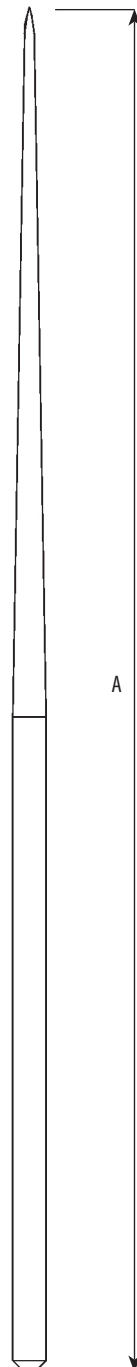

	A	B
128 99 0031	18,0 cm	10 mm
128 99 0032	18,0 cm	15 mm
128 99 0033	18,0 cm	20 mm
128 99 0035	18,0 cm	25 mm
128 99 0036	18,0 cm	30 mm
128 99 0037	18,0 cm	35 mm
128 99 0038	18,0 cm	40 mm

LAMBOTTE**128 99 0038**18,0 cm
40 mm





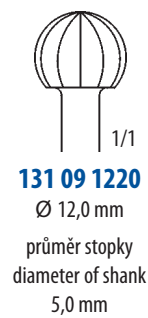

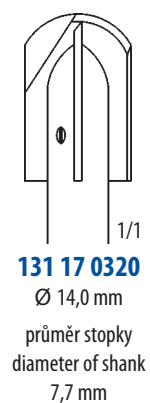
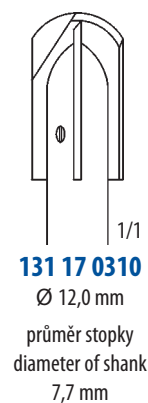
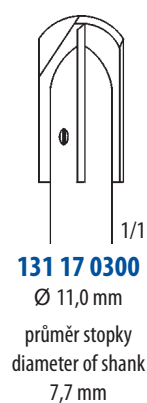
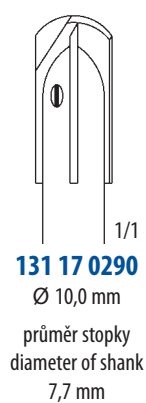
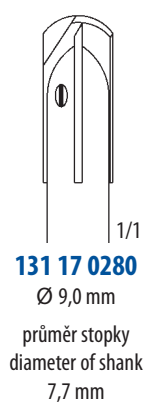
**VRTAČKA KOLOVRÁTKOVÁ
 HAND DRILL**

**FRÉZY TREPANAČNÍ
 CUTTERS**

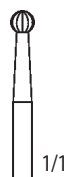

131 29 0050



131 29 0010
Ø 3,0 mm
průměr stopky
diameter of shank
2,35 mm
Fig. 1

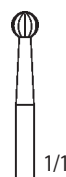

131 29 0020
Ø 3,5 mm
průměr stopky
diameter of shank
2,35 mm
Fig. 2



131 29 0030
Ø 4,0 mm
průměr stopky
diameter of shank
2,35 mm
Fig. 3

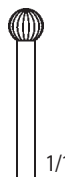

131 29 0040
Ø 4,5 mm
průměr stopky
diameter of shank
2,35 mm
Fig. 4

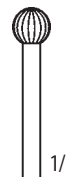

131 29 0050
Ø 5,0 mm
průměr stopky
diameter of shank
2,35 mm
Fig. 5



131 29 0120



131 29 0100
Ø 5,0 mm
průměr stopky
diameter of shank
2,35 mm
Fig. 1



131 29 0120
Ø 7,0 mm
průměr stopky
diameter of shank
2,35 mm
Fig. 3



131 29 0200
Fig. 1



Ø 5,0 mm
průměr stopky
diameter of shank
2,35 mm



131 29 0460

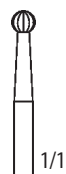

131 29 0450
Ø 2,7 mm
průměr stopky
diameter of shank
2,35 mm
Fig. 10



131 29 0460
Ø 3,1 mm
průměr stopky
diameter of shank
2,35 mm
Fig. 12



131 29 0470
Ø 3,5 mm
průměr stopky
diameter of shank
2,35 mm
Fig. 14







BOYNTON
132 38 0120
 12,5 cm



11,5 cm

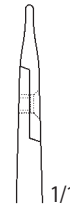

132 38 0210
 rovný mikro – straight micro
 1 mm

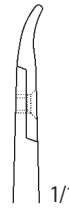

132 38 0220
 zahnutý mikro – curved micro
 1 mm

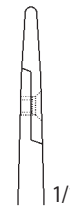

132 38 0230
 rovný – straight
 1,5 mm

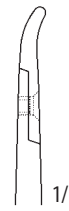

132 38 0240
 zahnutý – curved
 1,5 mm



FILLATOFF
132 38 0250
 14,4 × 9,0 cm

JEHELCE
NEEDLE HOLDERS

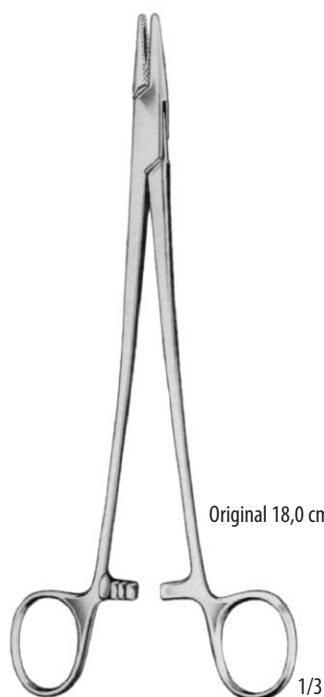

Original 18,0 cm

1/3

MAYO-HEGAR



1/1

132 91 0030

14,0 cm



1/1

132 91 0031

16,0 cm



1/1

132 91 0032

18,0 cm



1/1

132 91 0033

20,0 cm



1/1

132 91 0034

24,0 cm



1/1

132 91 0035

26,0 cm



1/1

132 91 0036

30,0 cm



1/1

132 91 0037

16,0 cm



1/1

MAYO-HEGAR-DELICATE

132 91 0038

18,0 cm



1/1

132 91 0039

20,0 cm

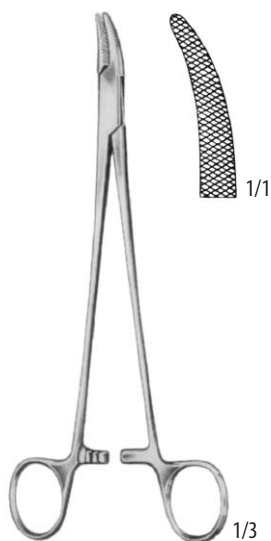

1/1

1/3

HEANEY

132 91 0040

21,0 cm

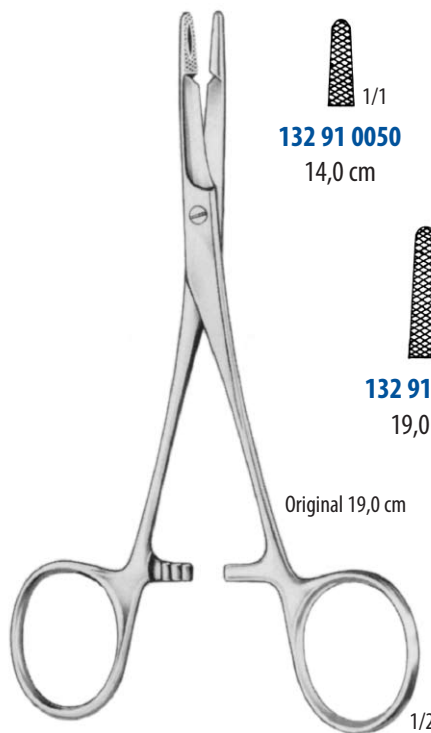

Original 19,0 cm

1/2



1/1

132 91 0050

14,0 cm



1/1

132 91 0051

17,0 cm



1/1

132 91 0052

19,0 cm



132 06 0200
14,0 cm

Original 17,2 cm

1/2

MATHIEU



132 06 0220
17,2 cm



132 91 0056
20,0 cm

Original 20,0 cm

1/2

MATHIEU

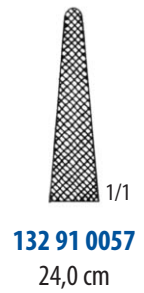

132 91 0057
24,0 cm



132 06 0300
15,0 cm

Original 15,0 cm

1/2

CRILE



132 06 0310
15,5 cm



132 06 0810
20,5 cm

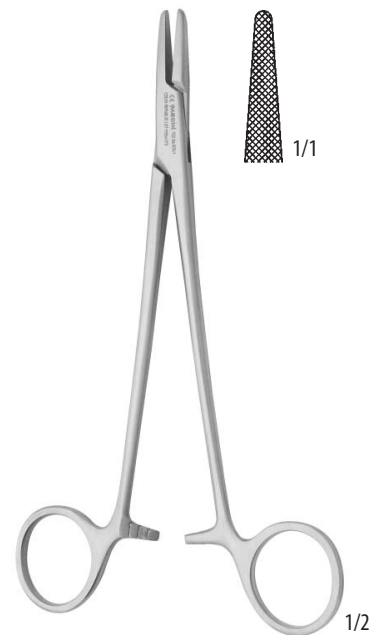

132 06 0341
16,5 cm

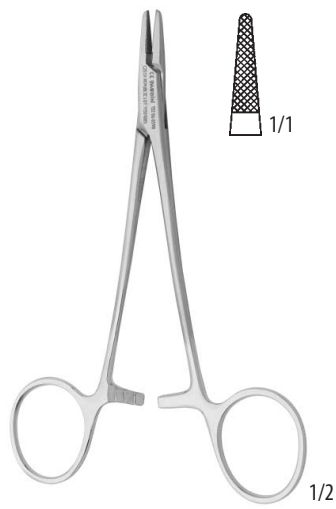
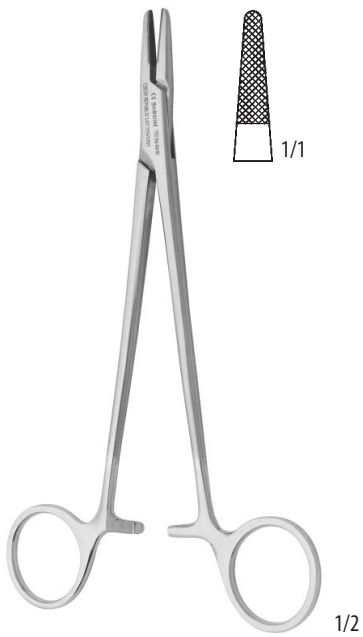
JEHELCE TVRDOKOVOVÉ
NEEDLE HOLDERS WITH TUNGSTEN CARBIDE INSERT

132 06 0590
 13,0 cm

132 06 0610
 16,5 cm

132 06 0620
 20,5 cm

132 06 0630
 25,5 cm

Original 20,5 cm

MAYO-HEGAR



1/1
132 91 0096
 14,0 cm



1/1
132 91 0097
 16,0 cm



1/1
132 91 0098
 18,0 cm



1/1
132 91 0099
 20,0 cm



1/1
132 91 0100
 24,0 cm



1/1
132 91 0101
 26,0 cm



1/1
132 91 0102
 30,0 cm

**DE BAKEY
 (MAYO-HEGAR-DELICATE)**



1/1
132 91 0103
 18,0 cm



1/1
132 91 0104
 20,0 cm



1/1
132 91 0105
 23,0 cm



1/1
132 91 0106
 26,0 cm



1/1
132 91 0107
 31,0 cm

JEHELCE TVRDOKOVOVÉ
NEEDLE HOLDERS WITH TUNGSTEN CARBIDE INSERT

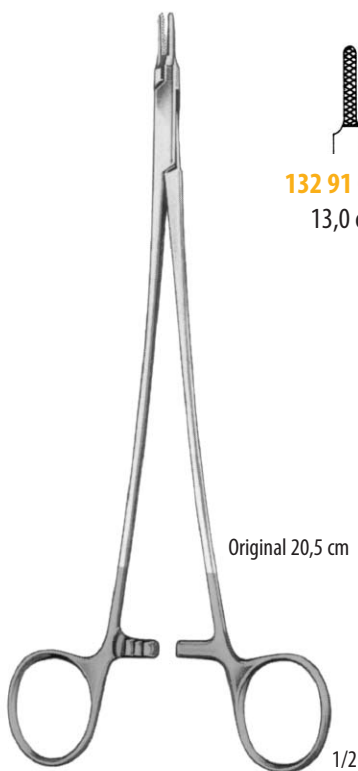

Original 20,5 cm

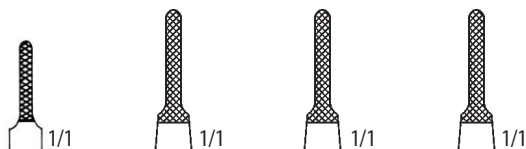

- 132 91 0108
13,0 cm
- 132 06 0600
16,5 cm
- 132 06 0640
20,5 cm
- 132 06 0650
25,5 cm

RYDER/FRENCH-EYE

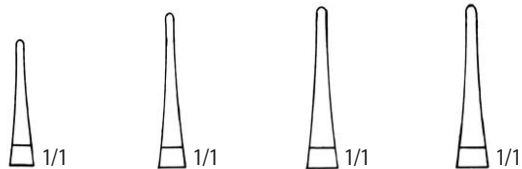

- 132 91 0120
14,0 cm
- 132 91 0121
18,0 cm
- 132 91 0122
20,0 cm
- 132 91 0123
23,0 cm



Original 20,0 cm

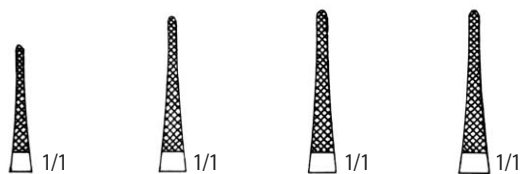

- 132 91 0124
14,0 cm
- 132 91 0125
18,0 cm
- 132 91 0126
20,0 cm
- 132 91 0127
23,0 cm

EUFRATE PASQUÉ
velmi jemné – extra delicate

MICROVASCULAR
velmi jemné – extra delicate



NEW ORLEANS

132 91 0130

18,0 cm

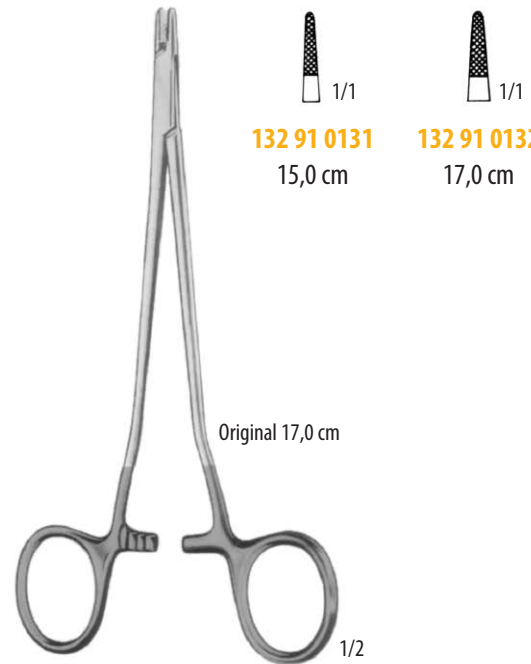

SENNING (SWED. MOD.)

132 91 0131

15,0 cm

132 91 0132

17,0 cm

Original 17,0 cm



DERF

132 91 0133

12,5 cm

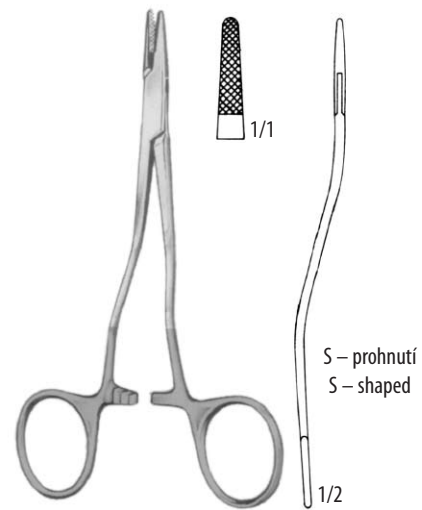

KILNER

132 91 0135

13,5 cm

S – prohnutí
S – shaped

JEHELCE TVRDOKOVOVÉ
NEEDLE HOLDERS WITH TUNGSTEN CARBIDE INSERT



WEBSTER
132 91 0137
13,0 cm



BABY-CRILE-WOOD
132 91 0140
15,0 cm



CRILE-WOOD
132 91 0142
15,0 cm

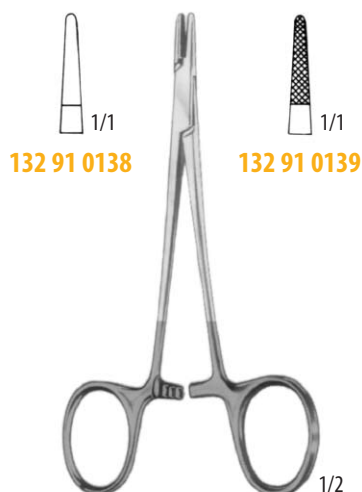

132 91 0138

132 91 0139

HALSEY
13,0 cm



CRILE-WOOD

Original 20,0 cm

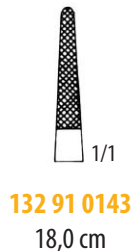

132 91 0143
18,0 cm

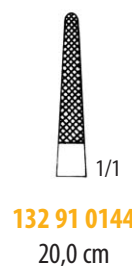

132 91 0144
20,0 cm

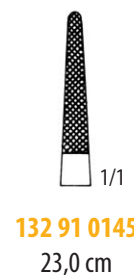

132 91 0145
23,0 cm

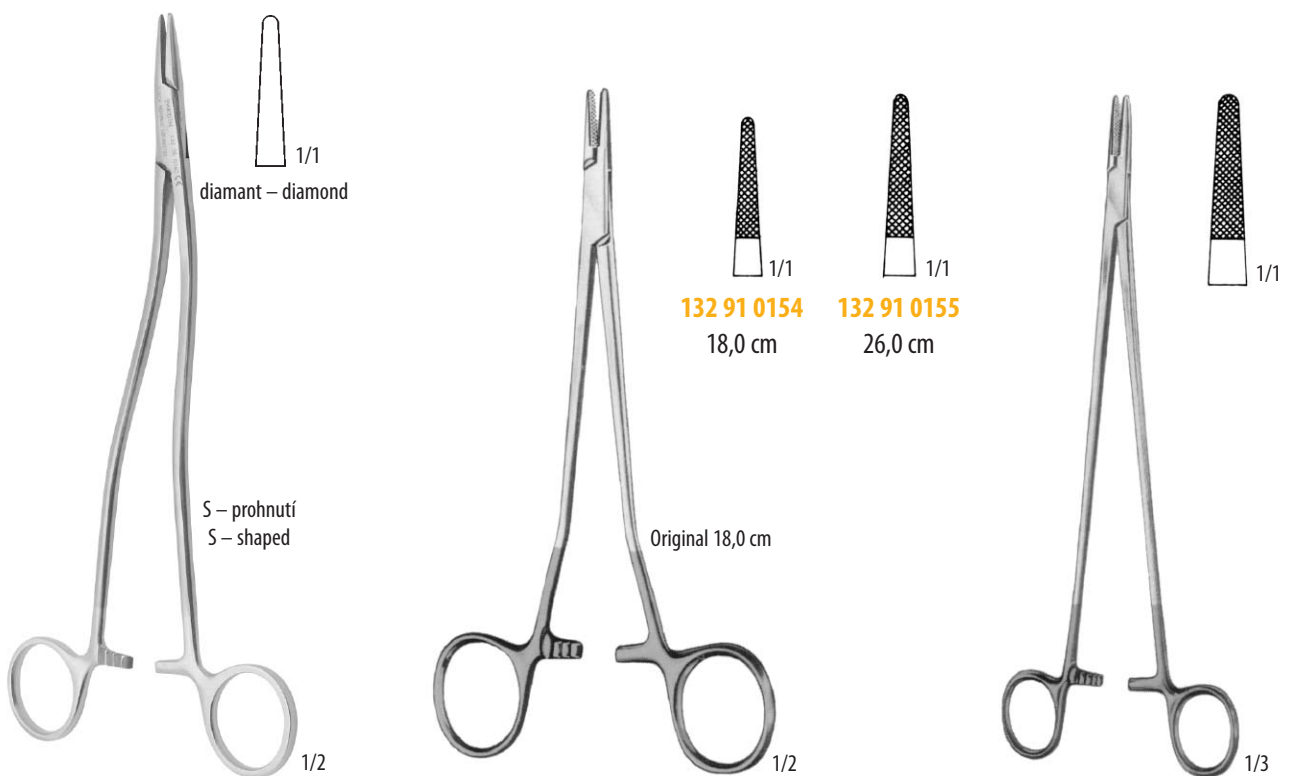

FINOCCHIETTO
WANGENSTEEN
BOZEMANN

**JEHELEC HLOUBKOVÝ
 NEEDLE HOLDER**
SAROT
MASSON
132 06 0740
 20,2 cm

132 91 0156
 27,0 cm

JEHELCE TVRDOKOVOVÉ
NEEDLE HOLDERS WITH TUNGSTEN CARBIDE INSERT

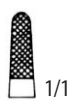

Original 19,0 cm



1/1

132 91 0160
14,0 cm

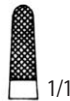

1/1

132 91 0161
17,0 cm



1/1

132 91 0162
19,0 cm

OLSEN-HEGAR



Original 21,5 cm



1/1

132 06 0520
14,0 cm



1/1

132 06 0500
17,2 cm



1/1

132 06 0510
21,5 cm



1/1

132 91 0167
24,0 cm

MATHIEU



Original 20,0 cm



1/1

132 91 0168
17,0 cm



1/1

132 91 0169
20,0 cm



1/1

132 91 0170
23,0 cm

MATHIEU

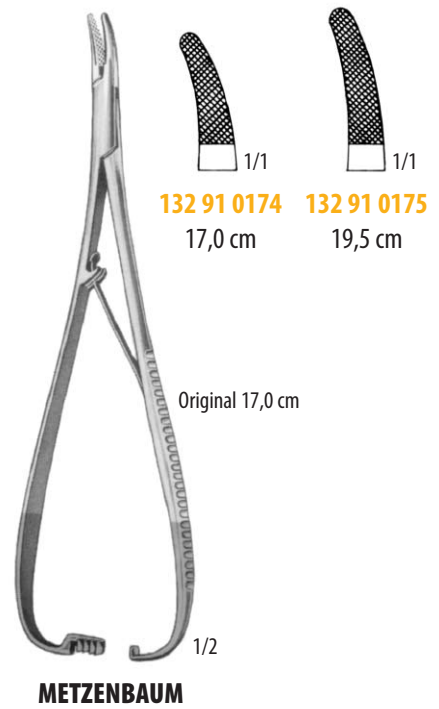

JEHELCE TVRDOKOVOVÉ
NEEDLE HOLDERS WITH TUNGSTEN CARBIDE INSERT

BOYNTON
132 91 0182
 12,0 cm



LUETHY-BECK
132 91 0192
 20,0 cm



HÖSEL
132 91 0186
 25,0 cm



LANGENBECK



132 91 0194
 18,0 cm



LANGENBECK

132 91 0195
 20,0 cm



132 91 0196
 18,0 cm

LANGENBECK-DELICATE



132 91 0197
 20,0 cm

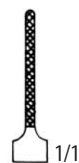

132 91 0199
 18,0 cm

LANGENBECK-RYDER

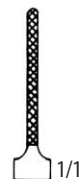

132 91 0200
 20,0 cm

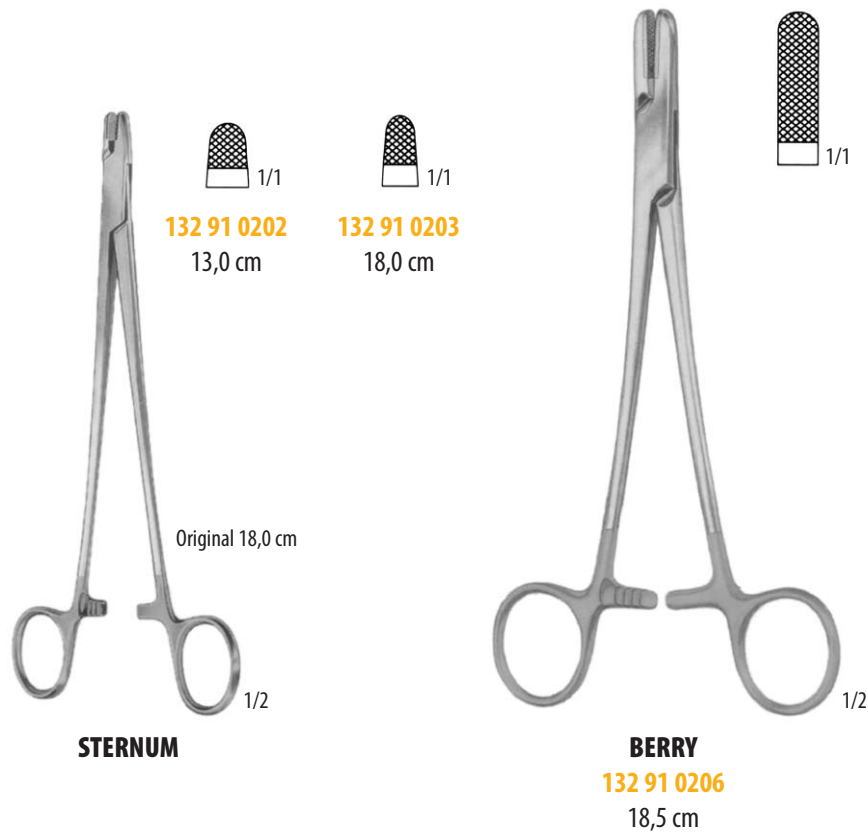
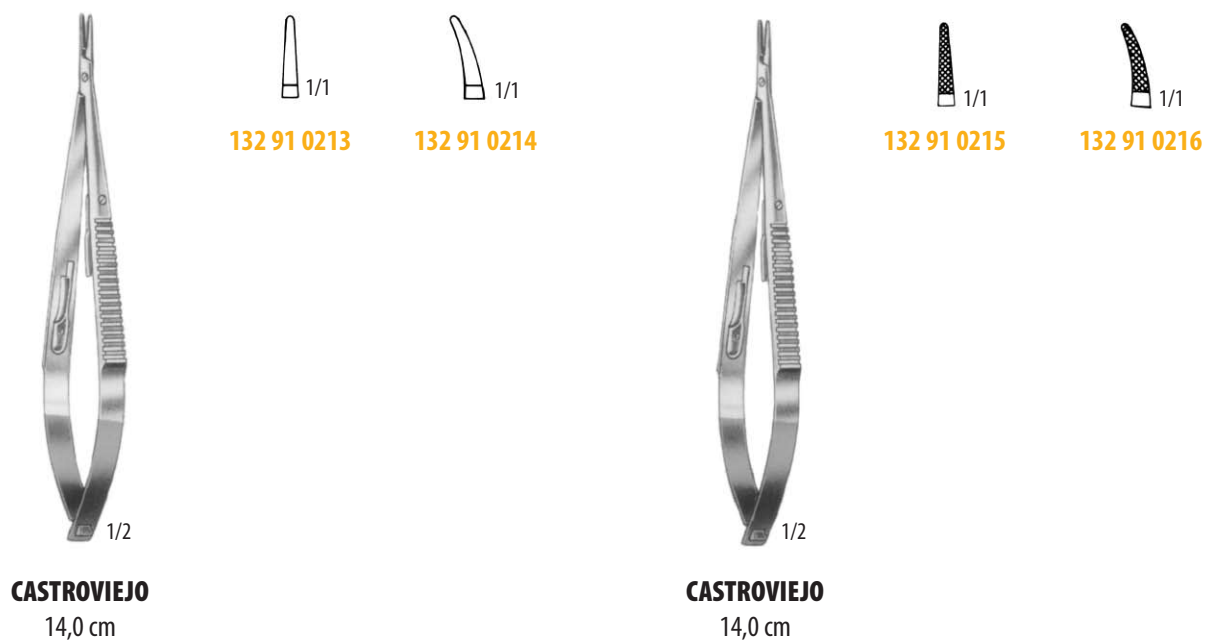
 MIKRO JEHELCE TVRDOKOVÉ
 MICRO-NEEDLE HOLDERS WITH TUNGSTEN CARBIDE INSERT

MIKRO JEHELCE TVRDOKOVOVÉ
MICRO-NEEDLE HOLDERS WITH TUNGSTEN CARBIDE INSERT



132 91 0217



132 91 0218

1/2

CASTROVIEJO
18,0 cm



132 91 0219



132 91 0220

1/2

CASTROVIEJO
18,0 cm

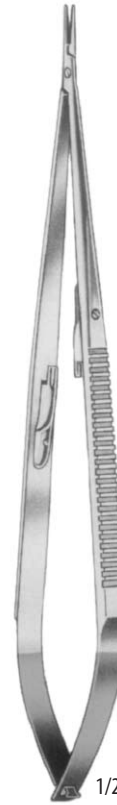

132 91 0221



132 91 0222

1/2

JACOBSON
21,0 cm



132 91 0223
16,0 cm



132 91 0224
18,0 cm



132 91 0225
20,0 cm



132 91 0226
23,0 cm



132 91 0227
26,0 cm

Original 23,0 cm

1/2

DIETRICH



1/2

CASTROVIEJO
132 91 0229
13,0 cm



1/2

POTTS-SMITH
132 91 0230
22,0 cm



BARRAQUER
132 91 0249
 rovný s uzávěrem
 straight with ratchet
 18,0 cm



BARRAQUER
132 91 0250
 zahnutý s uzávěrem
 curved with ratchet
 18,0 cm



BARRAQUER
132 91 0251
 rovný – straight
 18,0 cm

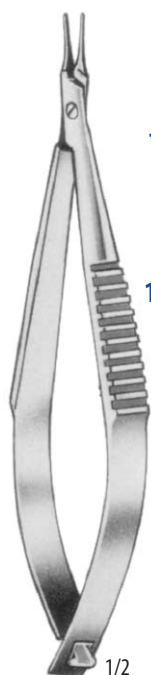

BARRAQUER
132 91 0252
 zahnutý – curved
 18,0 cm

MIKRO JEHELCE
MICRO-NEEDLE HOLDERS

132 91 0253

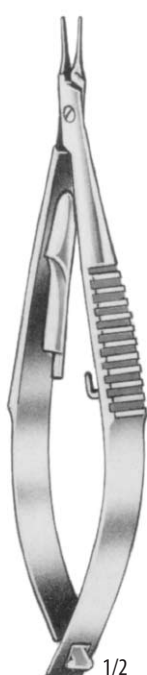

132 91 0254

CASTROVIEJO
 9,0 cm

132 91 0255

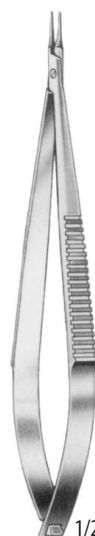

132 91 0256

CASTROVIEJO
 s uzávěrem – with ratchet
 9,0 cm

132 91 0257



132 91 0258



132 91 0259



132 91 0260

CASTROVIEJO
 14,0 cm

132 91 0261



132 91 0262



132 91 0263



132 91 0264

CASTROVIEJO
 s uzávěrem – with ratchet
 14,0 cm

132 91 0269

18,0 cm



132 91 0270

21,0 cm

Original 21,0 cm

JACOBSON
 s uzávěrem – with ratchet

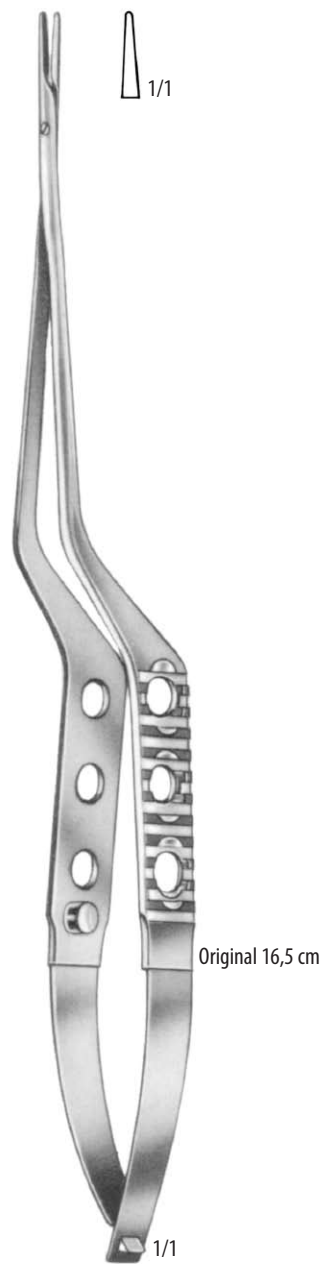

- 132 91 0271** 16,5 cm
- 132 91 0272** 18,0 cm
- 132 91 0273** 20,0 cm
- 132 91 0274** 22,0 cm

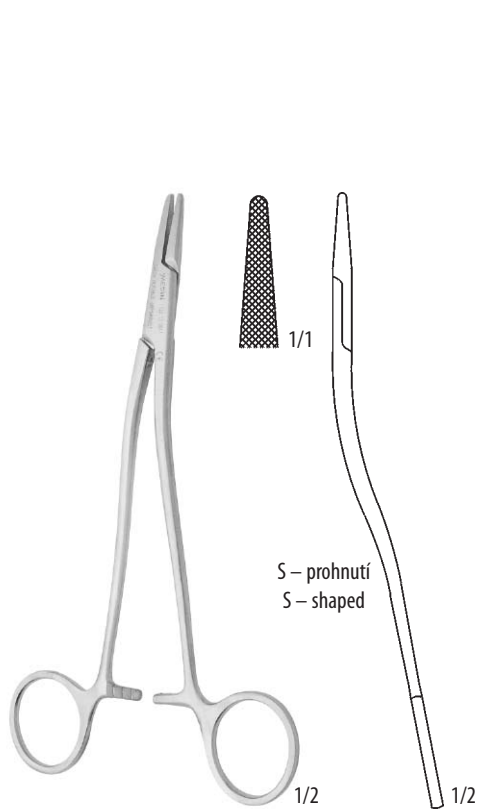
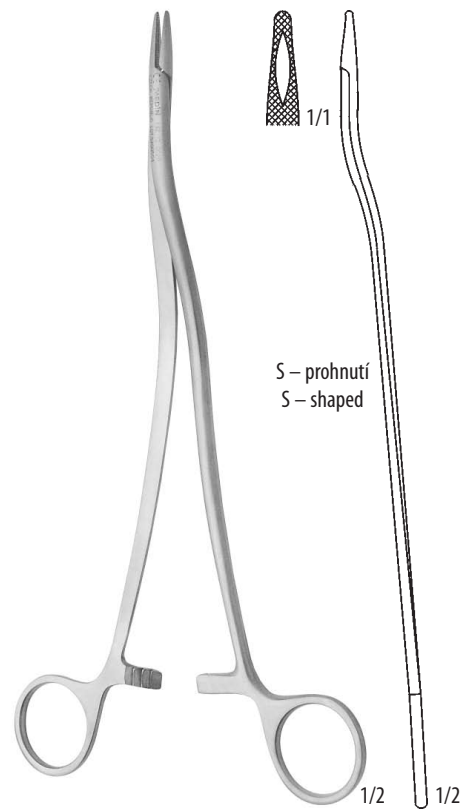

- 132 91 0275** 16,5 cm
- 132 91 0276** 18,0 cm
- 132 91 0277** 20,0 cm
- 132 91 0278** 22,0 cm

JEHELCE PRO PLASTIKU
NEEDLE HOLDERS FOR PLASTIC

132 12 0011
 16,2 cm

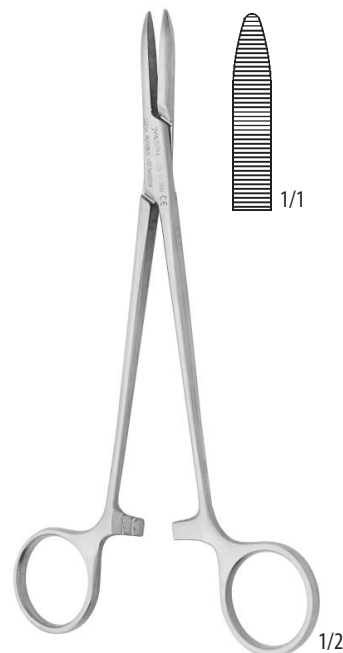
132 12 0020
 21,0 cm

JEHELCE NEUROCHIRURGICKÉ
NEUROSURGICAL NEEDLE HOLDERS

132 17 0021
 13,0 cm

132 17 0030
 17,0 cm



1/2

REVERDIN
 14,0 cm

1/1

132 91 0297
 Fig.1

1/1

132 91 0298
 Fig.2

1/1

132 91 0299
 Fig.3

1/1

132 91 0300
 Fig.4

Original 19,5 cm

1/2

REVERDIN
 19,5 cm
 22,5 cm

1/1

132 91 0301
132 91 0305
 Fig.1

1/1

132 91 0302
132 91 0306
 Fig.2



1/1

132 91 0303
132 91 0307
 Fig.3

1/1

132 91 0304
132 91 0308
 Fig.4

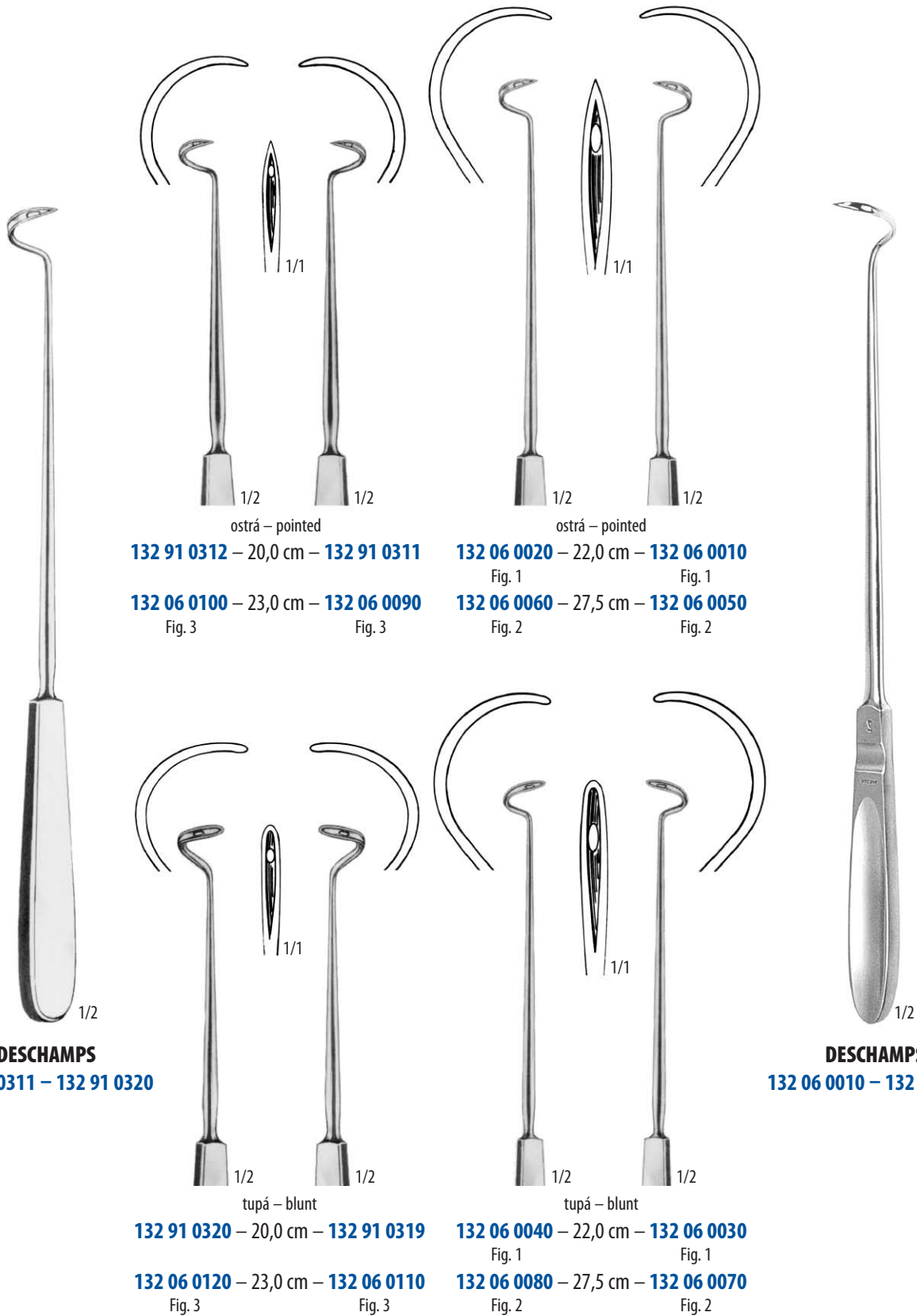
JEHLY PODVAZOVACÍ
LIGATURE NEEDLES



ostrá – pointed
132 91 0312 – 20,0 cm – **132 91 0311**
132 06 0100 – 23,0 cm – **132 06 0090**
 Fig. 3 Fig. 3

ostrá – pointed
132 06 0020 – 22,0 cm – **132 06 0010**
 Fig. 1 Fig. 1
132 06 0060 – 27,5 cm – **132 06 0050**
 Fig. 2 Fig. 2

DESCHAMPS
132 91 0311 – 132 91 0320

DESCHAMPS
132 06 0010 – 132 06 0120

tupá – blunt
132 91 0320 – 20,0 cm – **132 91 0319**
132 06 0120 – 23,0 cm – **132 06 0110**
 Fig. 3 Fig. 3

tupá – blunt
132 06 0040 – 22,0 cm – **132 06 0030**
 Fig. 1 Fig. 1
132 06 0080 – 27,5 cm – **132 06 0070**
 Fig. 2 Fig. 2



BRUNNER
30,0 cm

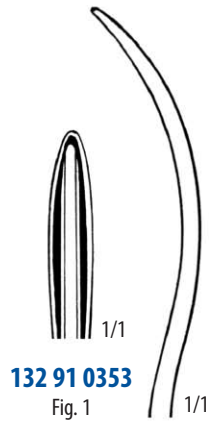

132 91 0353
Fig. 1

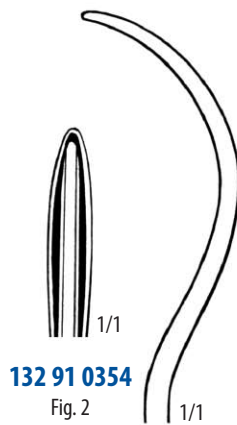

132 91 0354
Fig. 2



DURHAM
24,6 cm

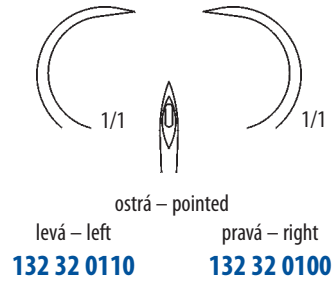

132 32 0110

132 32 0100

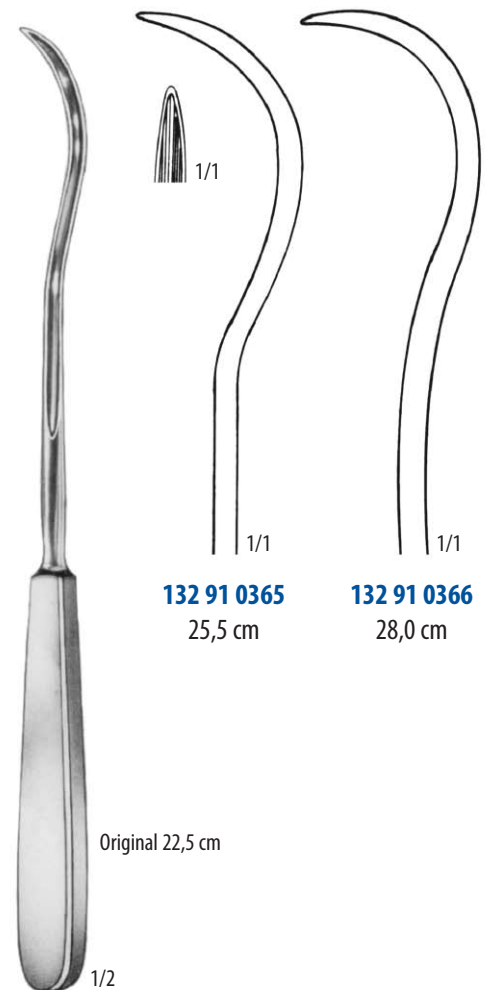

KIRSCHNER

Original 22,5 cm

132 91 0365
25,5 cm

132 91 0366
28,0 cm

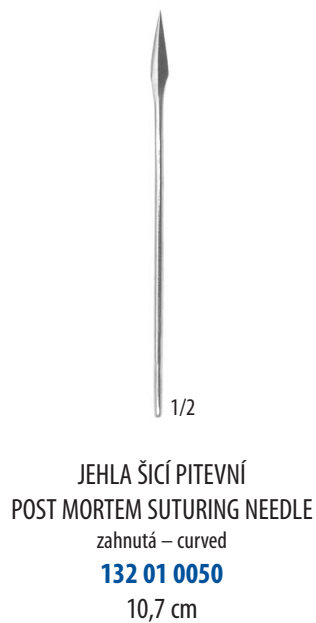

JEHLA ŠÍCÍ PITEVNÍ
POST MORTEM SUTURING NEEDLE
zahnutá – curved
132 01 0050
10,7 cm



1/2

PAYR
132 91 0358
22,0 cm



1/2

PAYR
132 91 0359
22,0 cm

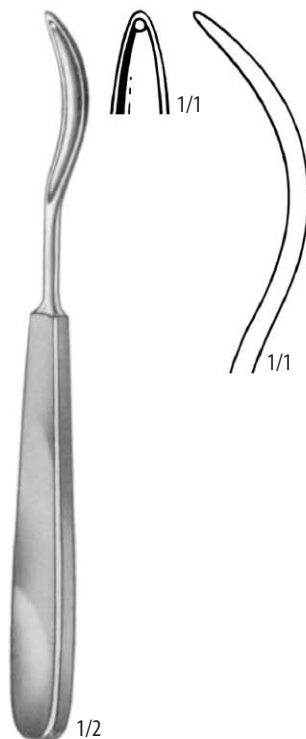

1/2

SCHMIEDEN-PAYR
132 91 0360
19,0 cm

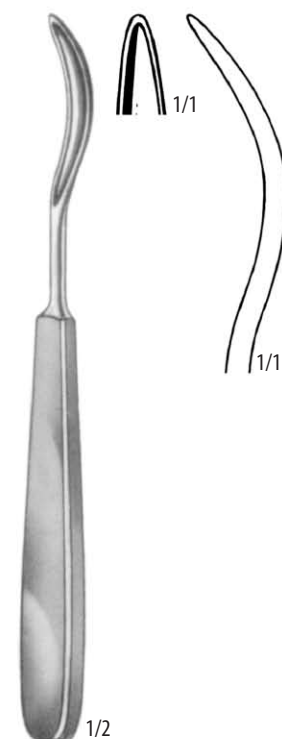

1/2

SCHMIEDEN-PAYR
132 91 0361
19,0 cm

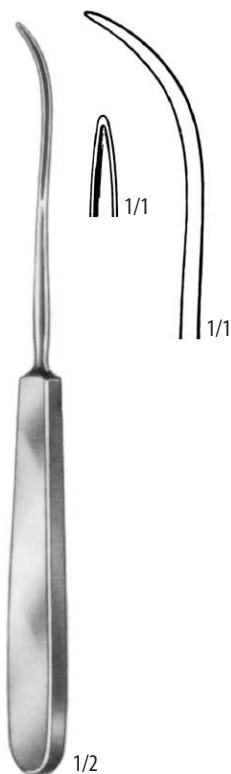

1/2

KÖNIG
132 91 0362
19,5 cm

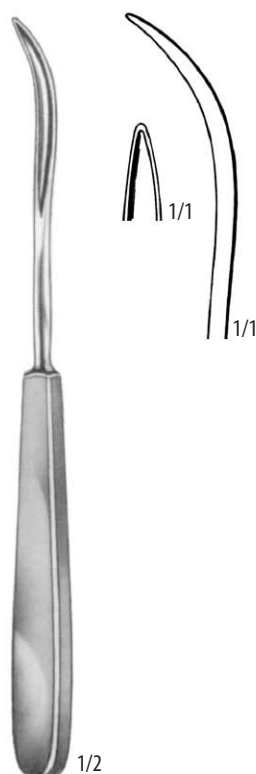

1/2

KÖNIG
132 91 0363
19,5 cm

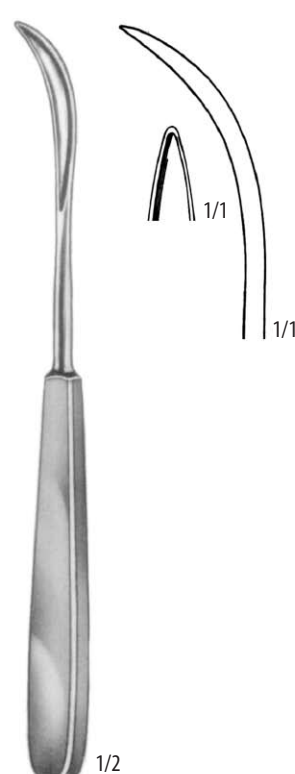

1/2

KÖNIG
132 91 0364
19,5 cm

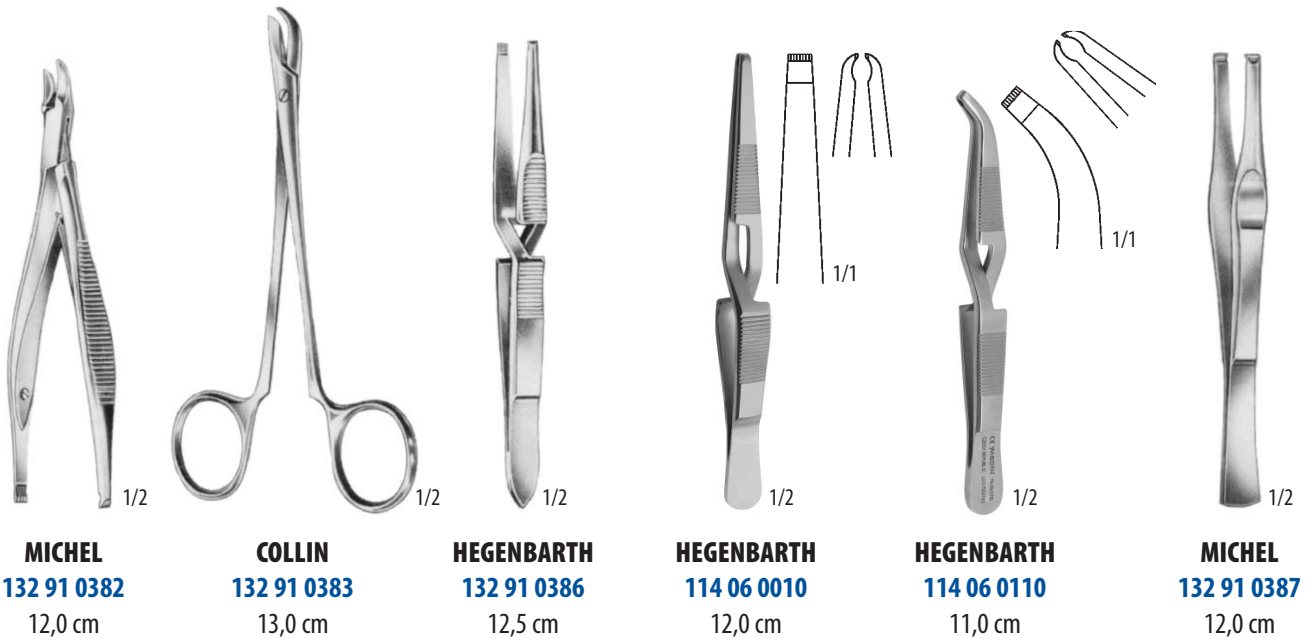

Balení: 10 × 100 ks
 Unit for sale: 10 × 100 pcs

Objednávací číslo Order number	Velikosti Sizes
132 91 0391	7,5 × 1,75 mm
132 91 0392	11,0 × 2,5 mm
132 91 0393	12,0 × 3,0 mm
132 91 0394	14,0 × 3,0 mm
132 91 0395	16,0 × 3,0 mm
132 91 0396	18,0 × 3,0 mm
132 91 0397	20,0 × 3,0 mm
MICHEL 132 91 0398	22,0 × 3,0 mm



BŘIŠNÍ A STŘEVNÍ SEŠÍVACÍ APARÁT
STOMACH AND INTESTIAL SUTURING APPARATUS

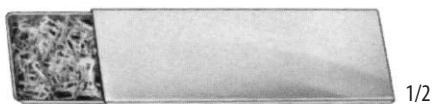

v. PETZ
132 91 0413
 komplet
 complete

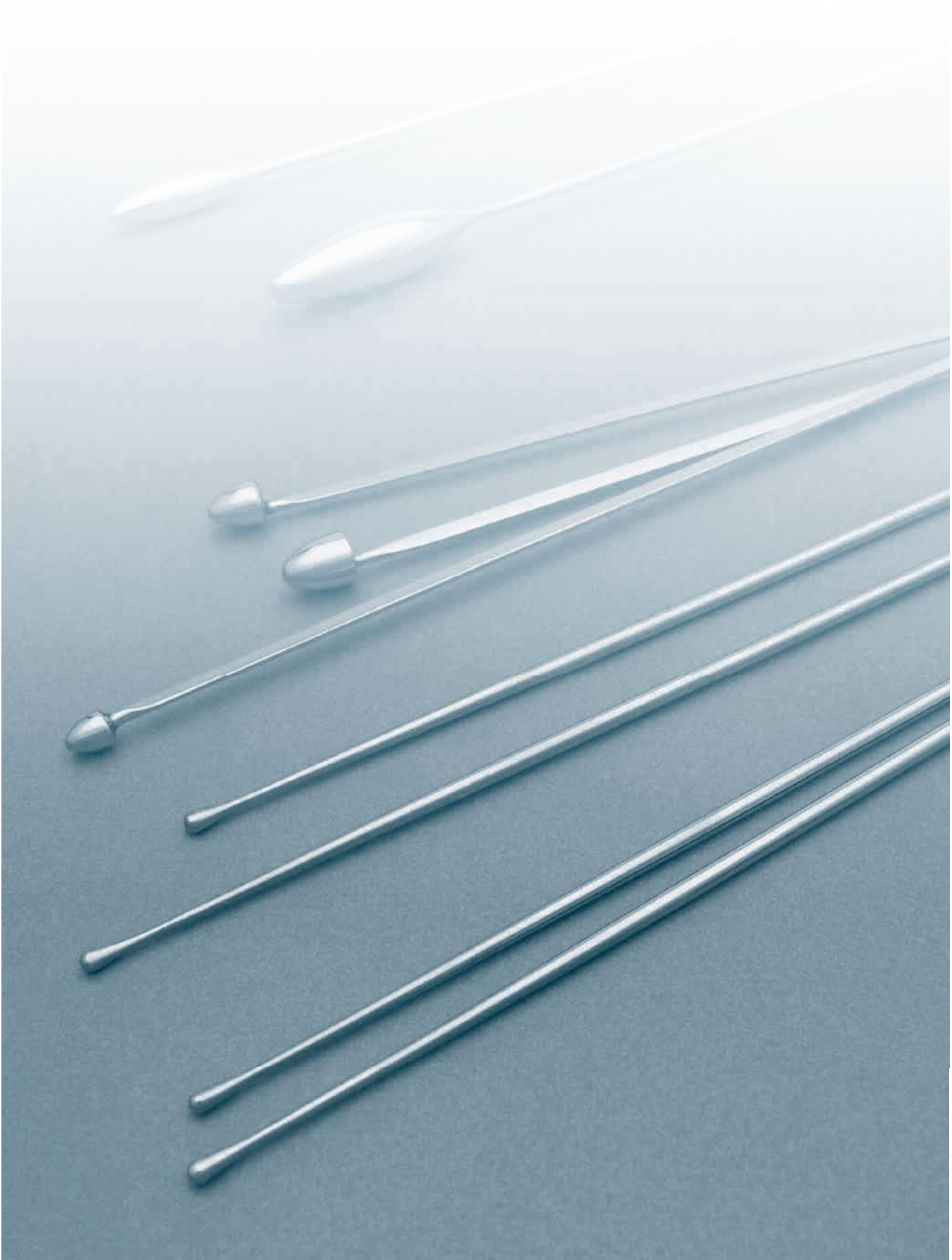

SVORKY ŠÍCÍ
 SUTURE FORCEPS
132 91 0400
 balení 300 ks
 package of 300 ea.



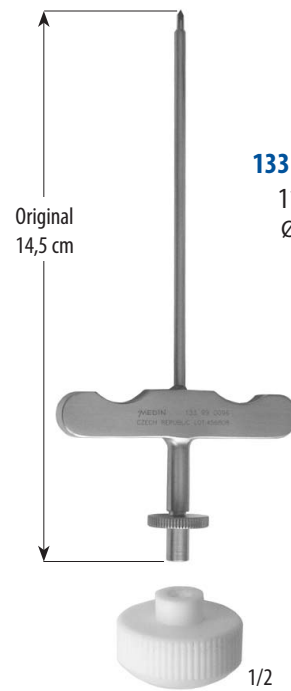
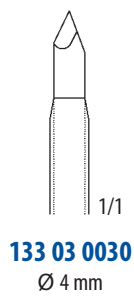
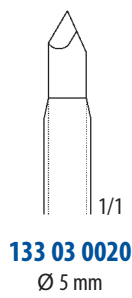



PÁTRADLO PALIČKOVÉ
PROBE OLIVE
133 08 0020 – 15,0 cm
133 08 0050 – 20,0 cm
133 08 0060 – 25,0 cm

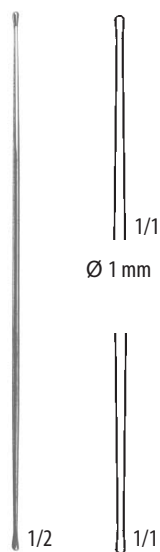

PÁTRADLO PALIČKOVÉ
PROBE OLIVE
133 08 0140
14,5 cm



PÁTRADLO ŽLÁBKOVÉ
PROBE
133 08 0090
13,6 cm



PÁTRADLO PALIČKOVÉ S DLÁTKEM
PROBE OLIVE WITH CHISEL
133 08 0100 – 15,0 cm
133 08 0110 – 20,0 cm
133 08 0120 – 25,0 cm

SOUBOR SOND NA KŘEČOVÉ ŽÍLY
VARICOSE VEIN PROBES SET

133 91 0060
3,0 mm



133 91 0061
6,0 mm



133 91 0062
9,0 mm



133 91 0063
12,0 mm

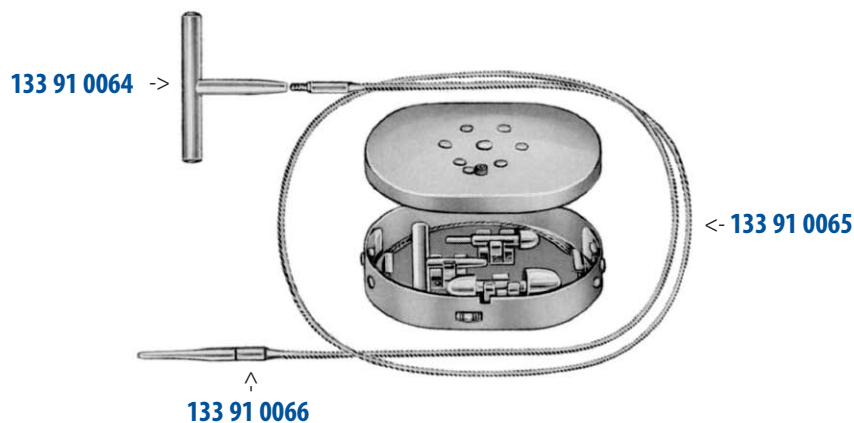

NABATOFF
133 91 0059
sada – set
18,0 cm

PÁTRADLA NA ŽLUČOVOD
GALL DUCT PROBES

DESJARDINES
133 20 0010
27,0 cm

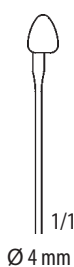

DESJARDINES
133 20 0020
27,0 cm



DESJARDINES
133 20 0030
27,0 cm



DESJARDINES
133 20 0040
sada – set
133 20 0010
133 20 0020
133 20 0030

BAKEŠ
133 20 0050
soubor – set



133 20 0070

17,0 cm
Ø 2,5 mm

133 20 0080

18,0 cm
Ø 3,0 mm

133 20 0090

17,3 cm
Ø 4,0 mm

133 20 0100

21,5 cm
Ø 5,0 mm

133 20 0110

22,8 cm
Ø 6,0 mm

133 20 0120

19,0 cm
Ø 7,0 mm

133 20 0130

24,0 cm
Ø 8,0 mm

133 20 0140

25,2 cm
Ø 9,0 mm

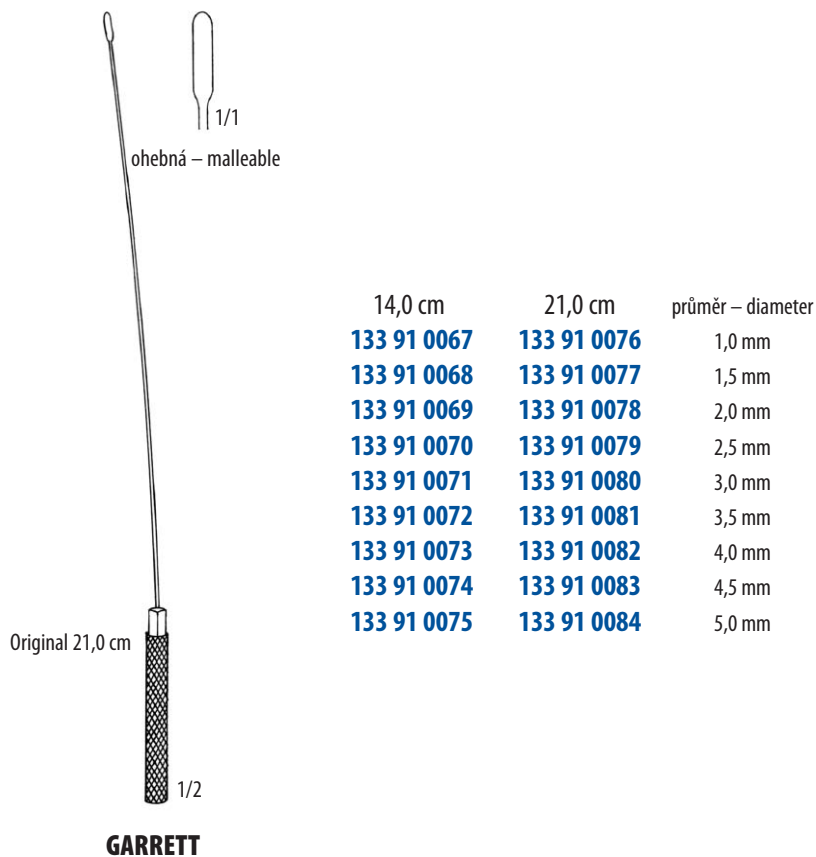
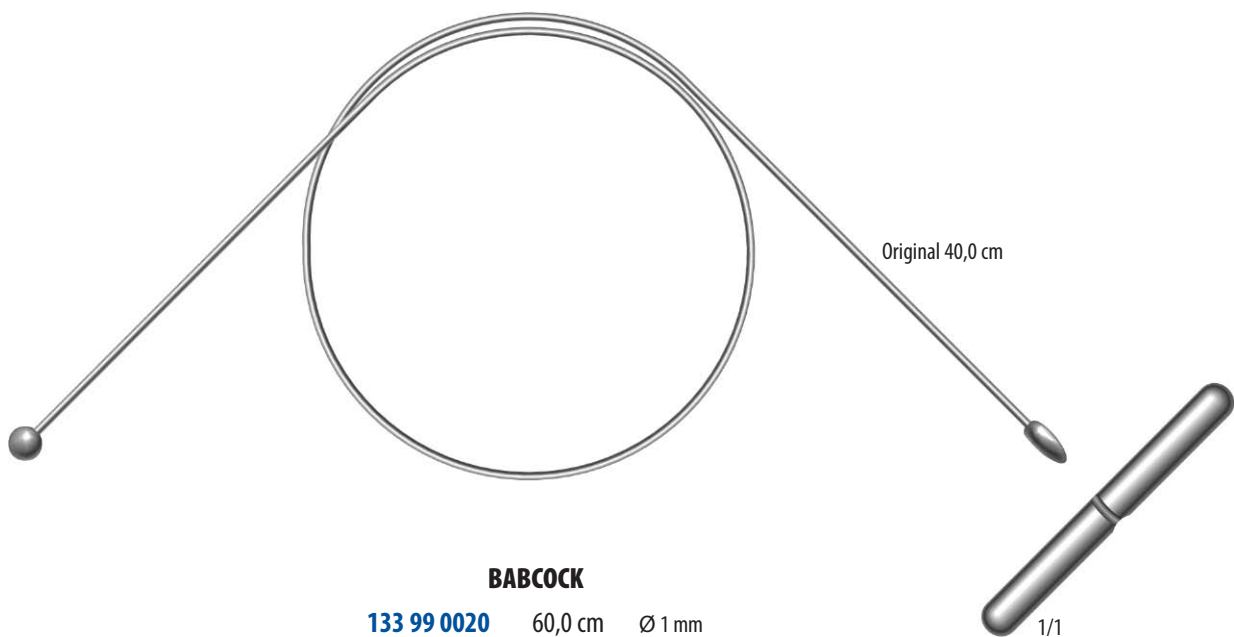
PÁTRADLO OHEBNÉ
PROBE FLEXIBLE

133 99 0020	60,0 cm	Ø 1 mm
133 99 0021	40,0 cm	Ø 1 mm
133 99 0023	70,0 cm	Ø 1 mm
133 99 0024	80,0 cm	Ø 1 mm



133 20 0400
43,0 cm



133 20 0410
43,0 cm



133 20 0420
43,0 cm

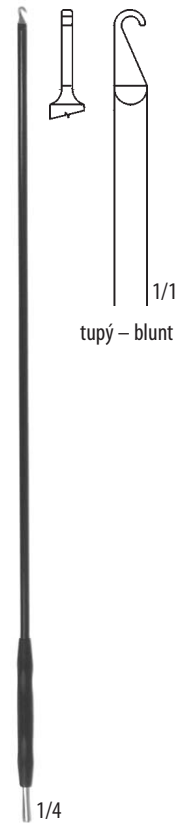

133 20 0430
43,0 cm

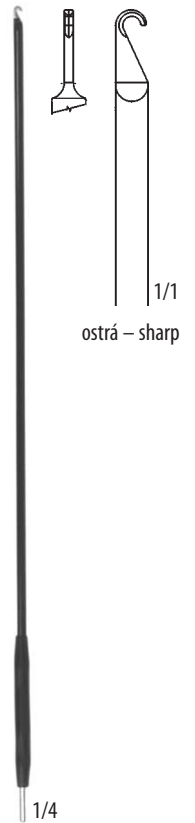

133 20 0440
43,0 cm

PÁTRADLA DĚLOŽNÍ
UTERINE PROBES

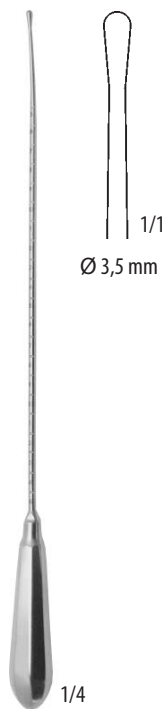

SIMS
133 27 0011
36,5 cm

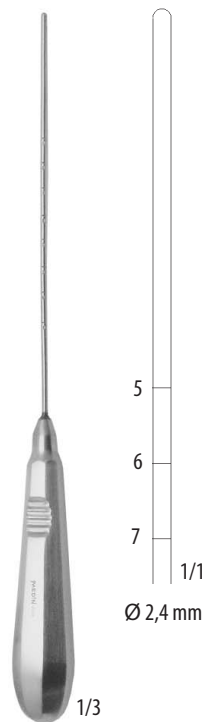

133 27 0130
28,0 cm

UROLOGICKÉ SONDY S OLIVKAMI
UROLOGICAL PROBES WITH OLIVES
**133 22 0170**

19,6 cm
12 Ch
14 Ch
18 Ch
16 Ch

**133 22 0190**

19,6 cm
14 Ch
16 Ch
20 Ch
18 Ch

**133 22 0180**

20,6 cm
20 Ch
22 Ch
26 Ch
24 Ch

**133 22 0200**

20,6 cm
22 Ch
24 Ch
28 Ch
26 Ch

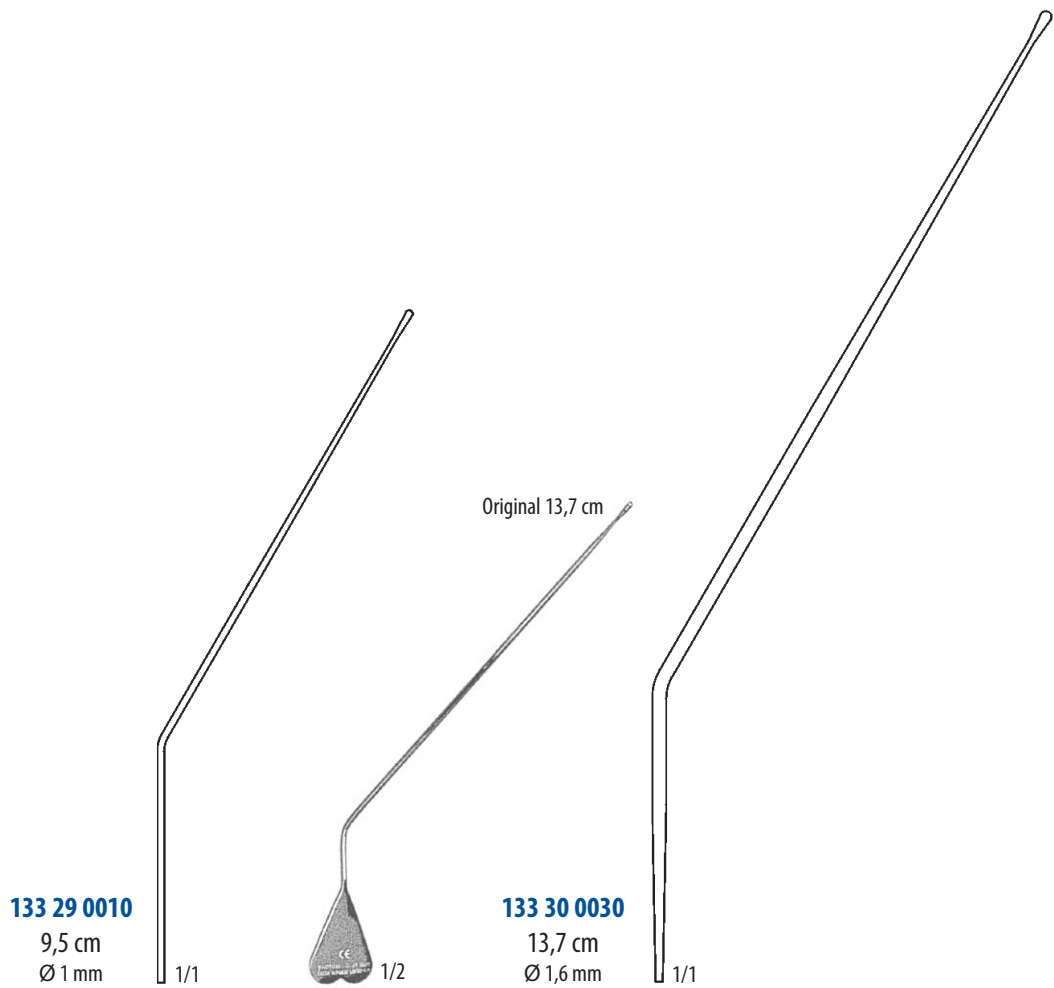
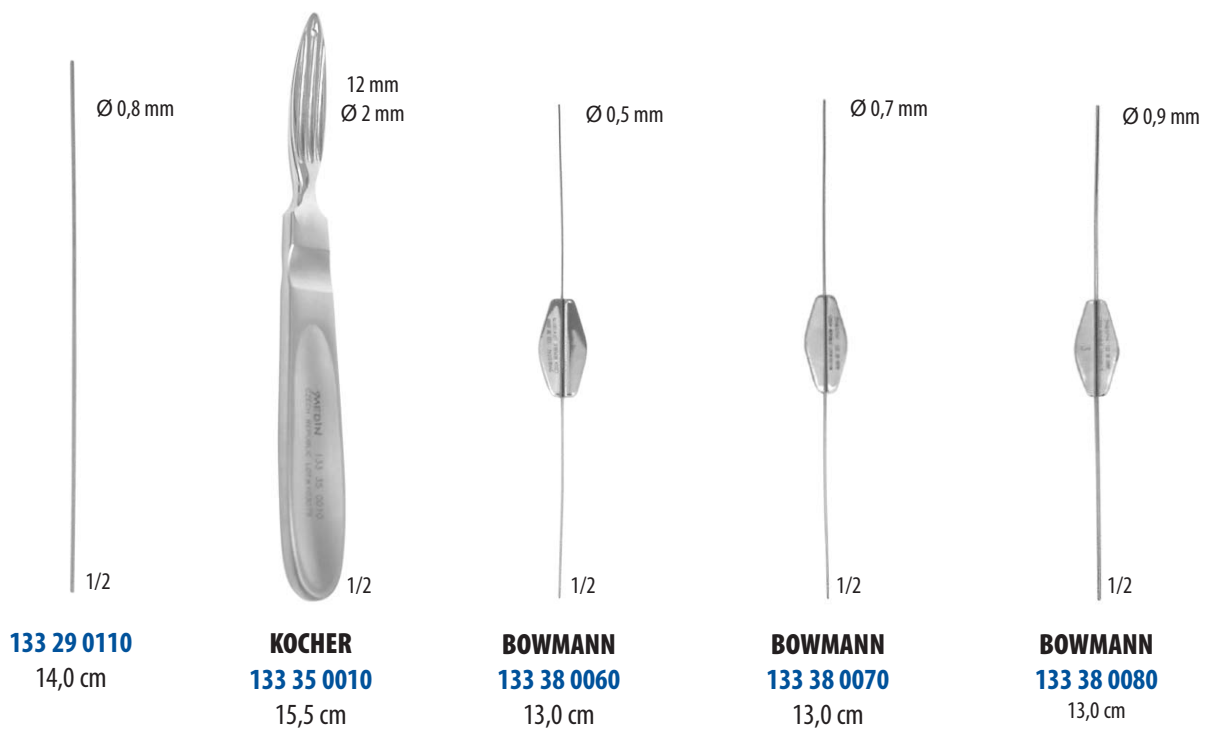
 DRÁTEK NA VÝTĚŘY, PÁTRADLO NA STRUMU, PÁTRADLA OČNÍ
SWAB WIRE, GOITRE PROBE, EYE PROBES

DILATÁTORY OČNÍ
EYE DILATORS

133 38 0110
7,5 cm
Ø 0,1 mm



133 38 0120
7,5 cm
Ø 0,25 mm



133 38 0130
7,5 cm
Ø 0,4 mm

SONDY OČNÍ DUTÉ
EYE PROBES

133 38 0200
10,0 cm
Ø 0,5 mm



133 38 0210
10,0 cm
Ø 0,6 mm



133 38 0220
10,0 cm
Ø 0,7 mm



133 38 0230
10,0 cm
Ø 0,8 mm



133 38 0240
10,0 cm
Ø 0,9 mm

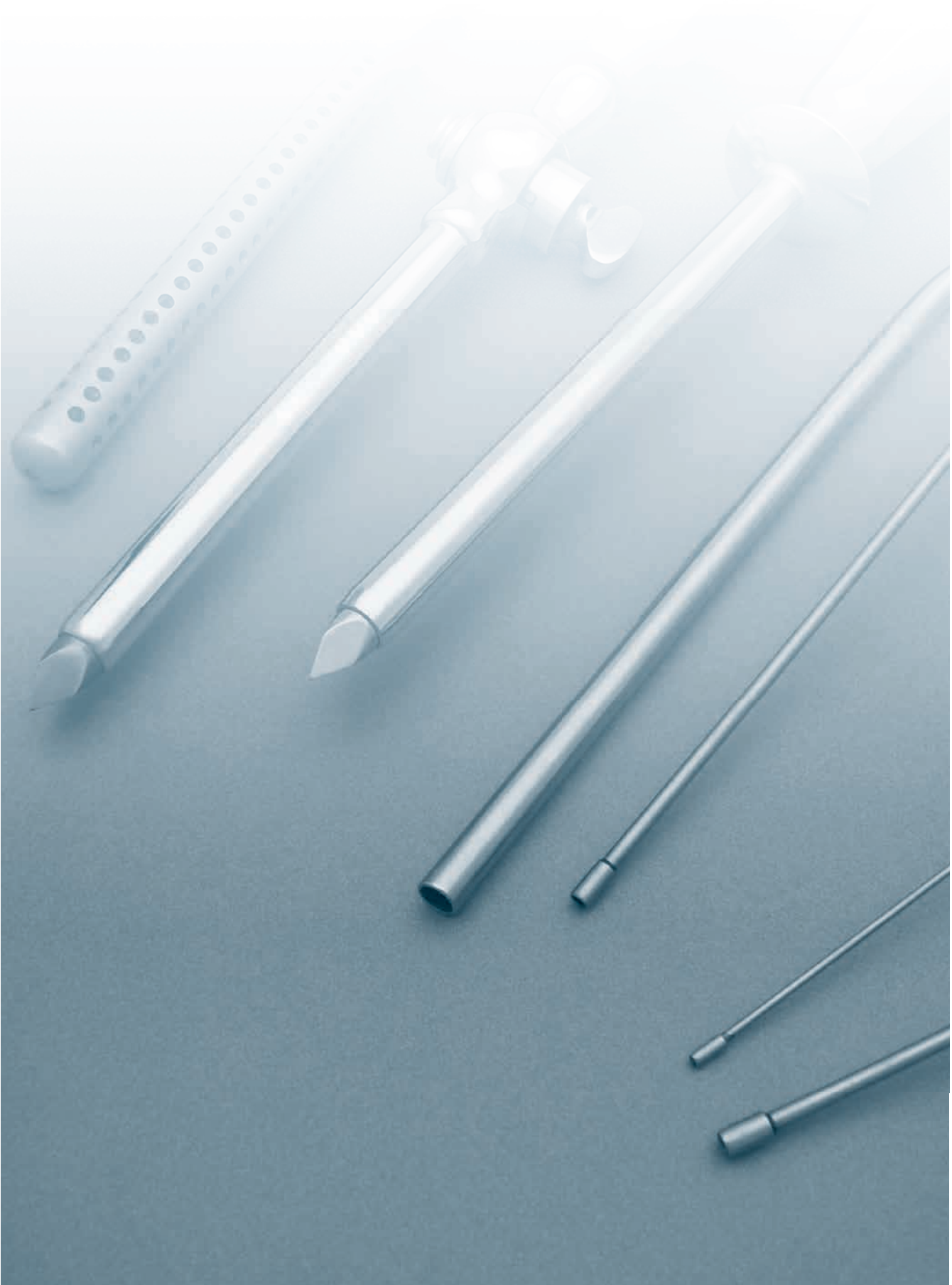



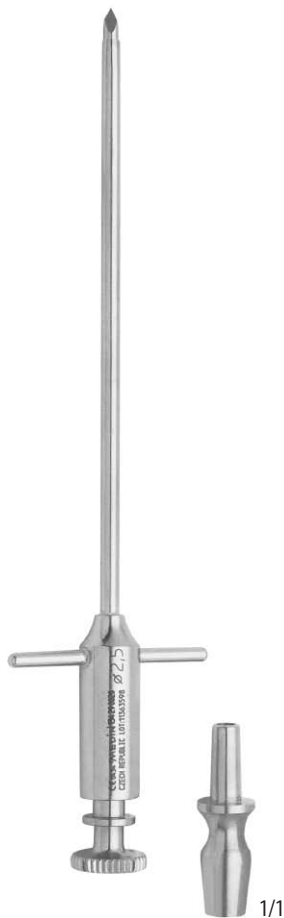

11,4 cm

134 29 0050

Ø 1,5 mm

134 29 0010

Ø 2,0 mm

134 29 0020

Ø 2,5 mm

134 29 0030

Ø 3,0 mm

134 29 0040

Ø 3,5 mm



1/2

134 91 0141

8 Ch

134 91 0142

10 Ch

134 91 0143

12 Ch

134 91 0144

14 Ch

134 91 0145

16 Ch

134 91 0146

18 Ch

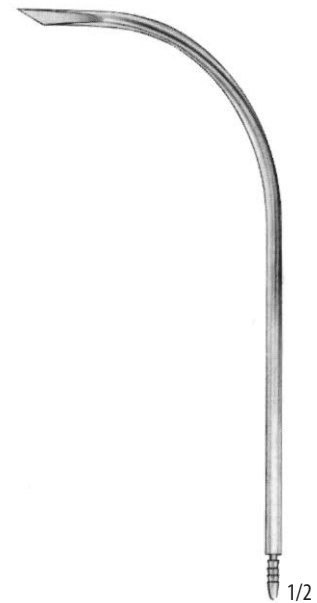

1/2

134 91 0147

8 Ch

134 91 0148

10 Ch

134 91 0149

12 Ch

134 91 0150

14 Ch

134 91 0151

16 Ch

134 91 0152

18 Ch

REDONOVA JEHLA
REDON NEEDLE

1/1

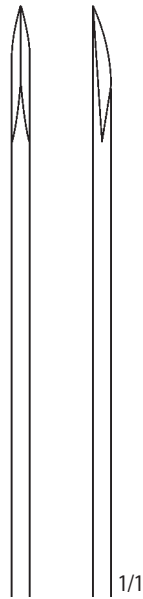

1/1

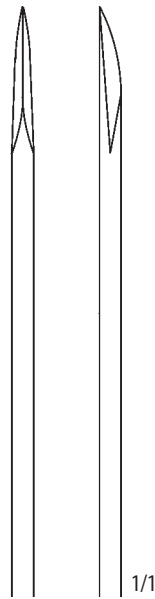
132 08 050016,0 cm
8 Ch

1/1

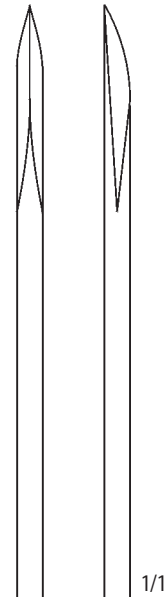
132 08 051016,0 cm
9 Ch

1/1

132 08 052016,0 cm
10 Ch

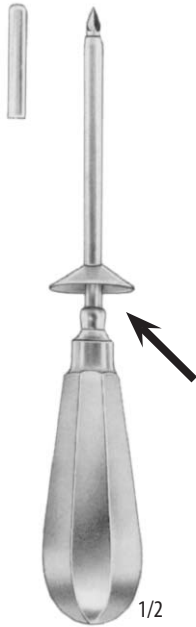

STANDARD

134 91 0007
Ø 3 mm

134 91 0008
Ø 4 mm

134 91 0009
Ø 5 mm

134 91 0010
Ø 6 mm

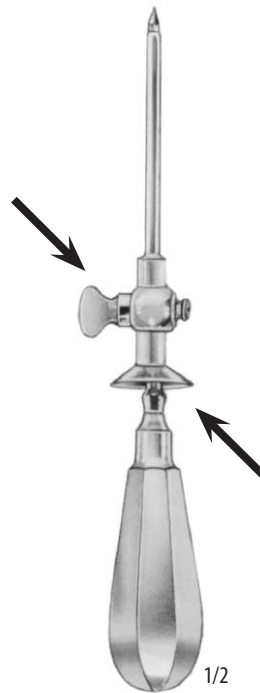

STANDARD

134 91 0011
Ø 3 mm

134 91 0012
Ø 4 mm

134 91 0013
Ø 5 mm

134 91 0014
Ø 6 mm

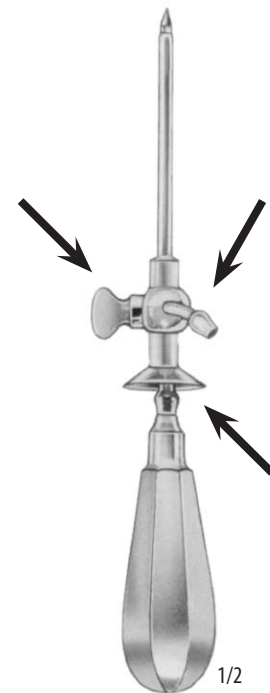

STANDARD

134 91 0015
Ø 3 mm

134 91 0016
Ø 4 mm

134 91 0017
Ø 5 mm

134 91 0018
Ø 6 mm

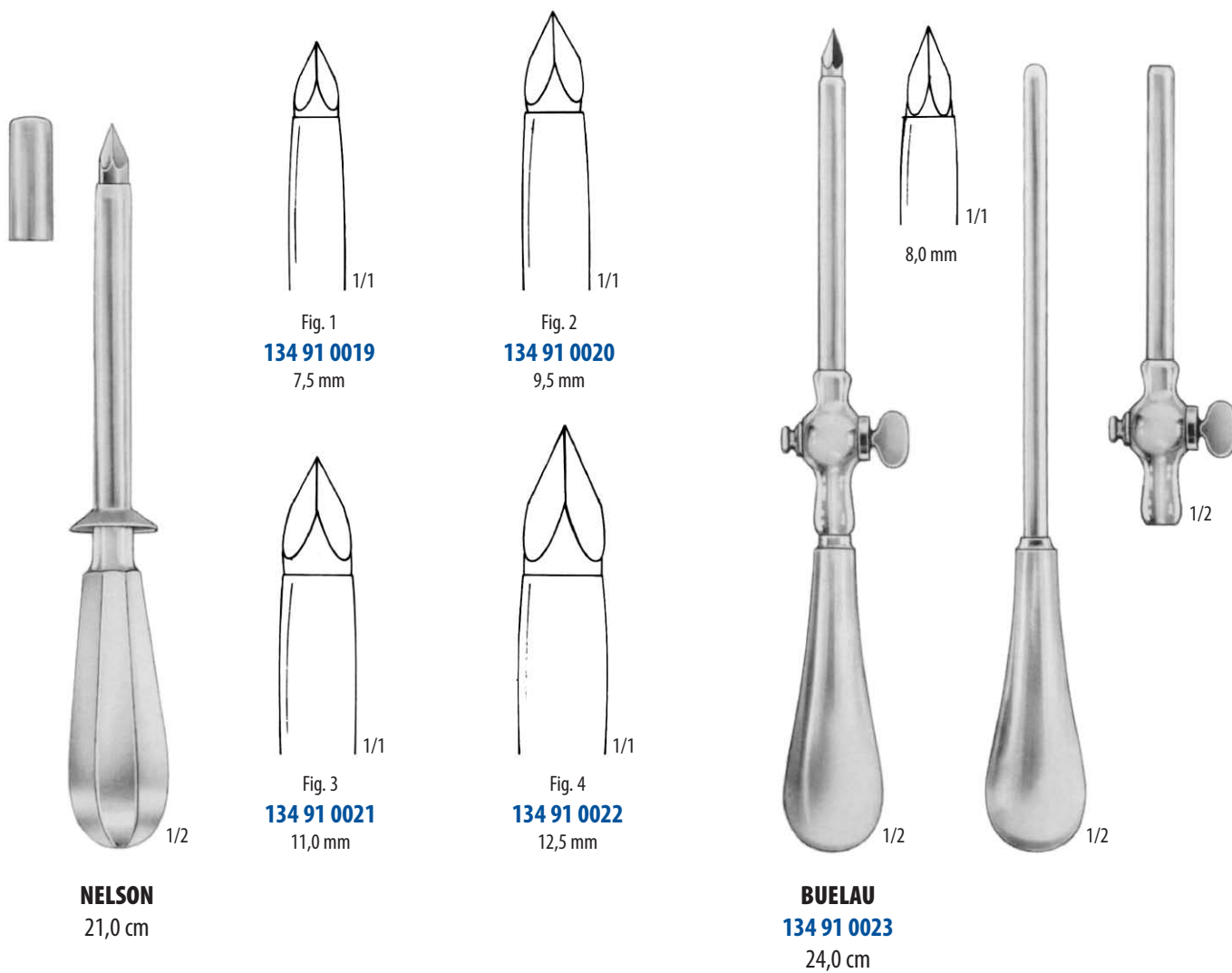



1/2

 DRŽADLO
 HANDLE

bez regulace – without regulation

134 08 0080

8,0 cm



1/2

 DRŽADLO
 HANDLE

s regulací – with regulation

134 08 0090

8,0 cm

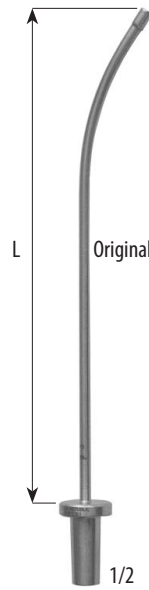

Original 13,0 cm

1/2

	L	Ø
134 08 0100	13,0 cm	1 mm
134 08 0110	13,0 cm	2 mm
134 08 0120	13,0 cm	3 mm
134 08 0200	15,0 cm	1 mm
134 08 0210	15,0 cm	2 mm
134 08 0220	15,0 cm	3 mm

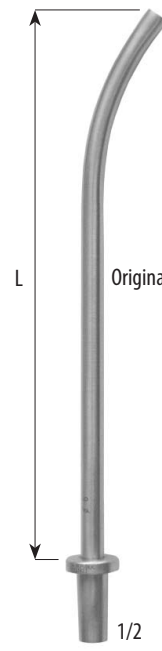

Original 14,5 cm

1/2

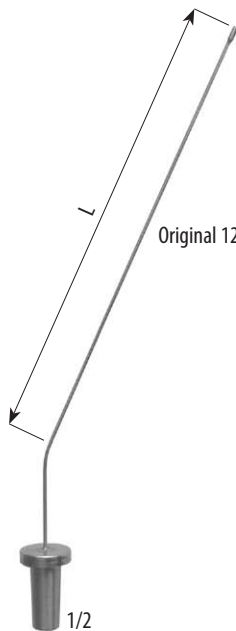

Original 12,0 cm

1/2

	L	Ø
134 08 0300	8,0 cm	1 mm
134 08 0310	8,0 cm	2 mm
134 08 0320	12,0 cm	1 mm
134 08 0330	12,0 cm	2 mm

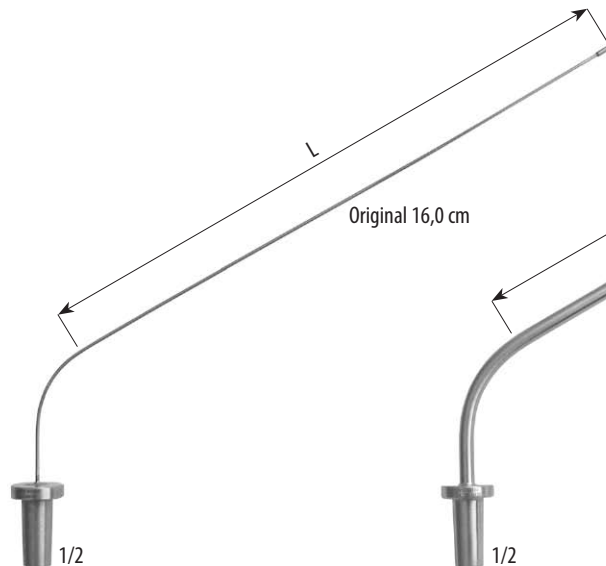

Original 16,0 cm

1/2

	L	Ø
134 08 0400	9,0 cm	1 mm
134 08 0410	9,0 cm	2 mm
134 08 0420	9,0 cm	3 mm
134 08 0500	12,0 cm	1 mm
134 08 0510	12,0 cm	2 mm
134 08 0520	12,0 cm	3 mm
134 08 0600	16,0 cm	1 mm
134 08 0610	16,0 cm	2 mm
134 08 0620	16,0 cm	3 mm

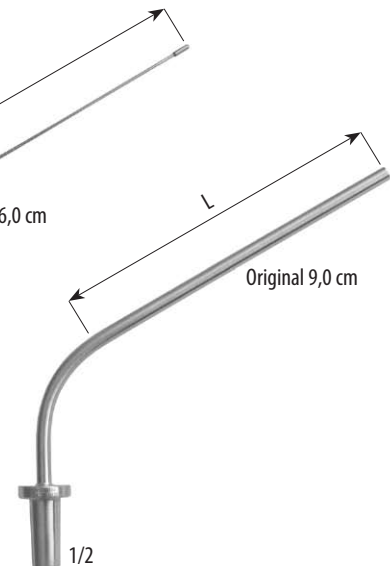

Original 9,0 cm

1/2

	L	Ø
134 08 0430	9,0 cm	4 mm
134 08 0440	9,0 cm	5 mm
134 08 0530	12,0 cm	4 mm
134 08 0540	12,0 cm	5 mm
134 08 0630	16,0 cm	4 mm
134 08 0640	16,0 cm	5 mm

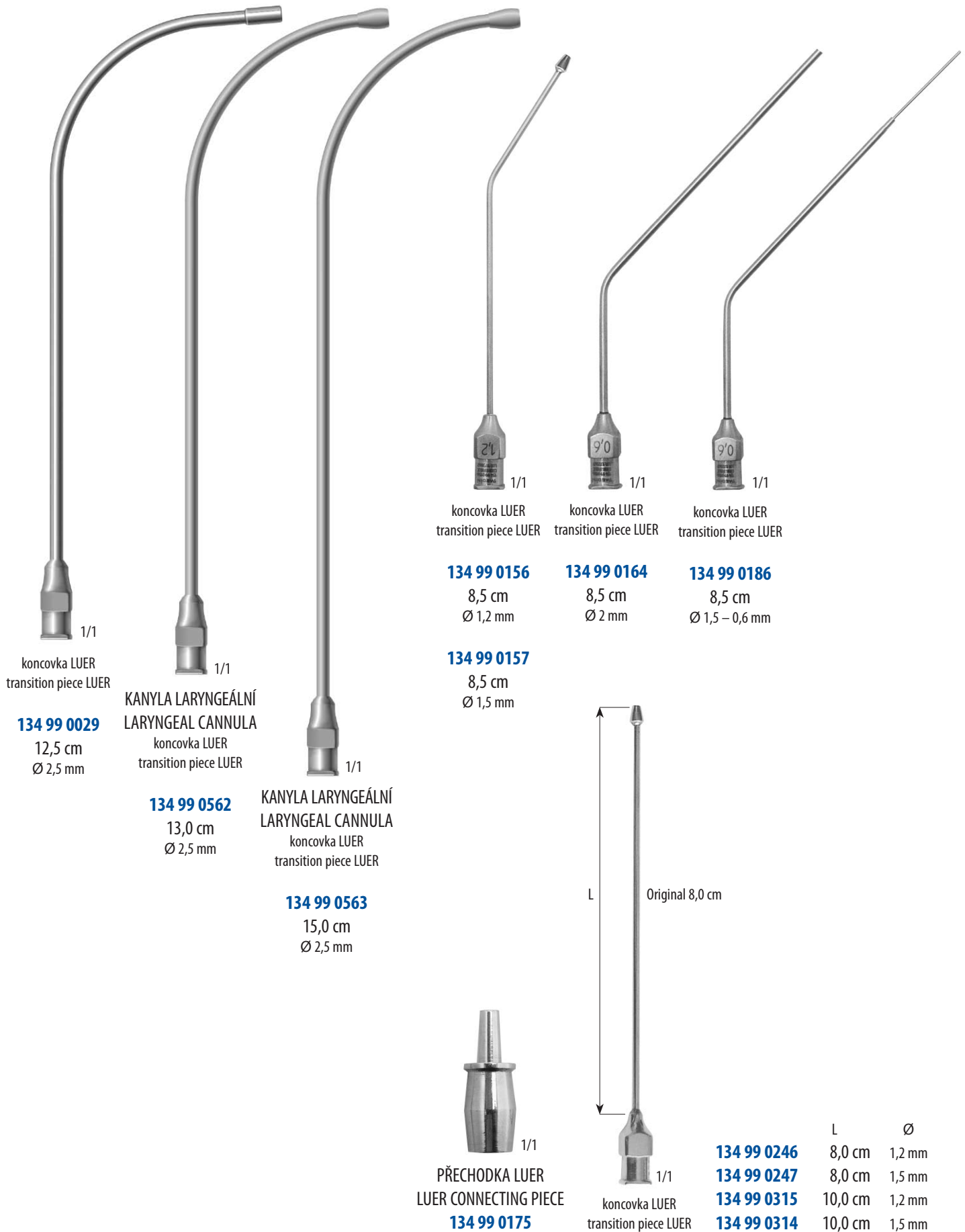
ODSÁVAČKY
SUCTION TUBES

1/1
koncovka LUER
transition piece LUER

134 99 0029
12,5 cm
Ø 2,5 mm

1/1
KANYLA LARYNGEÁLNÍ
LARYNGEAL CANNULA
koncovka LUER
transition piece LUER

134 99 0562
13,0 cm
Ø 2,5 mm

1/1
KANYLA LARYNGEÁLNÍ
LARYNGEAL CANNULA
koncovka LUER
transition piece LUER

134 99 0563
15,0 cm
Ø 2,5 mm

1/1
koncovka LUER
transition piece LUER

134 99 0156
8,5 cm
Ø 1,2 mm

1/1
koncovka LUER
transition piece LUER

134 99 0164
8,5 cm
Ø 2 mm

1/1
koncovka LUER
transition piece LUER

134 99 0186
8,5 cm
Ø 1,5 – 0,6 mm

1/1
PŘECHODKA LUER
LUER CONNECTING PIECE

134 99 0175

1/1
koncovka LUER
transition piece LUER

L
Original 8,0 cm

	L	Ø
134 99 0246	8,0 cm	1,2 mm
134 99 0247	8,0 cm	1,5 mm
134 99 0315	10,0 cm	1,2 mm
134 99 0314	10,0 cm	1,5 mm

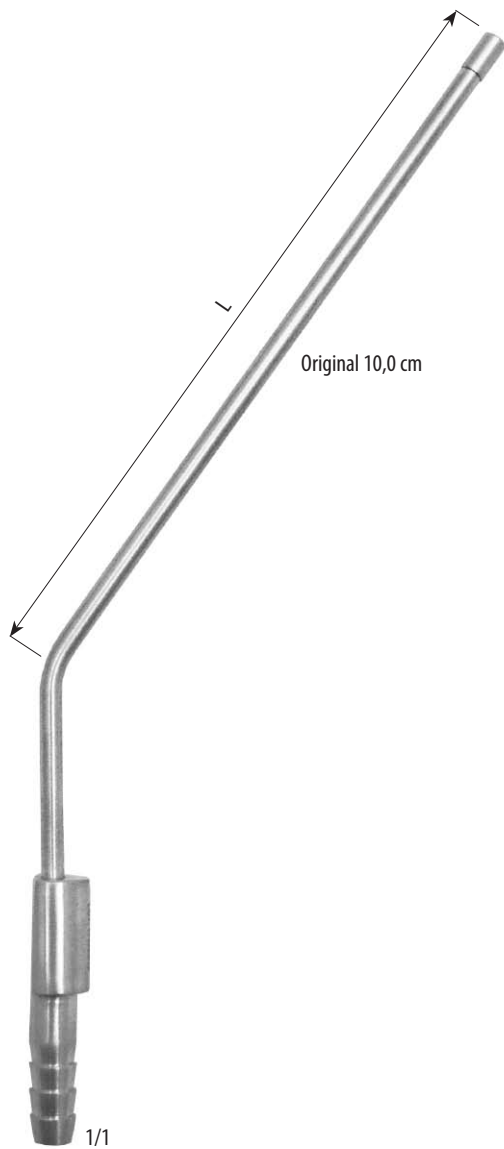

s regulací – with regulation

	L	Ø
134 99 0268	10,0 cm	1 mm
134 99 0126	10,0 cm	1,5 mm
134 99 0267	8,0 cm	1,5 mm
134 99 0128	5,0 cm	2 mm
134 99 0129	8,0 cm	2 mm
134 99 0130	10,0 cm	2 mm
134 99 0131	12,0 cm	2 mm
134 99 0132	5,0 cm	3 mm
134 99 0133	8,0 cm	3 mm
134 99 0134	10,0 cm	3 mm

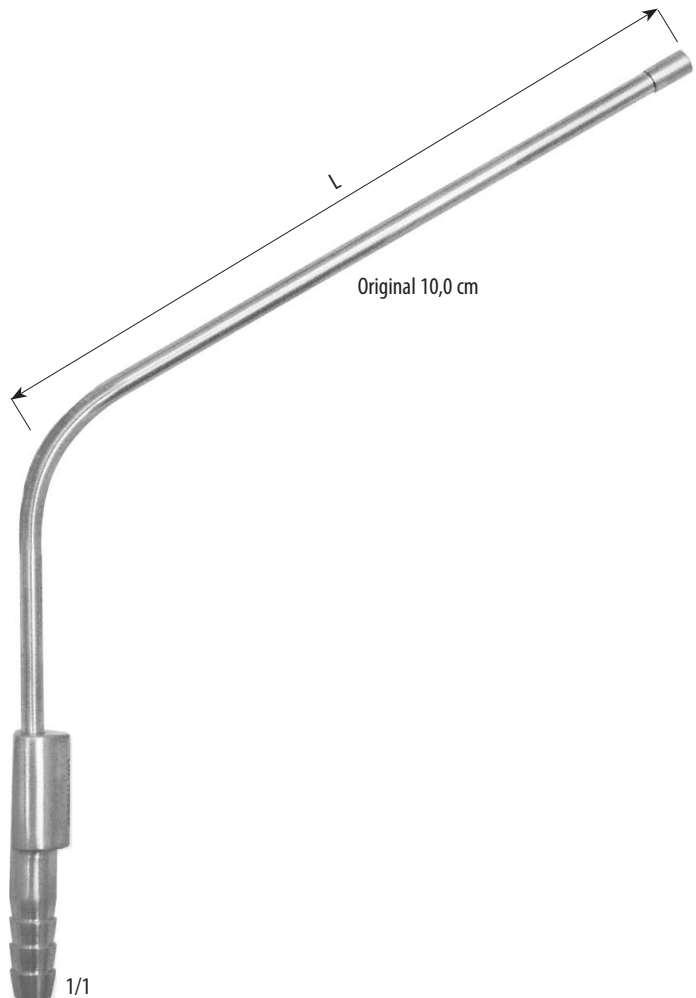

s regulací – with regulation

	L	Ø
134 99 0307	10,0 cm	2 mm
134 99 0308	8,0 cm	2 mm
134 99 0309	8,0 cm	1,5 mm
134 99 0310	5,0 cm	1,5 mm



YANKAUER
134 91 0050
27,0 cm
Ø 10 mm



DE BAKEY
134 91 0053
27,5 cm
Ø 9 mm



POOLE
134 91 0058
22,0 cm
Ø 10 mm



POOLE
134 91 0059
22,0 cm
Ø 8 mm



BABY-POOLE
134 91 0060
20,0 cm
Ø 5,5 mm

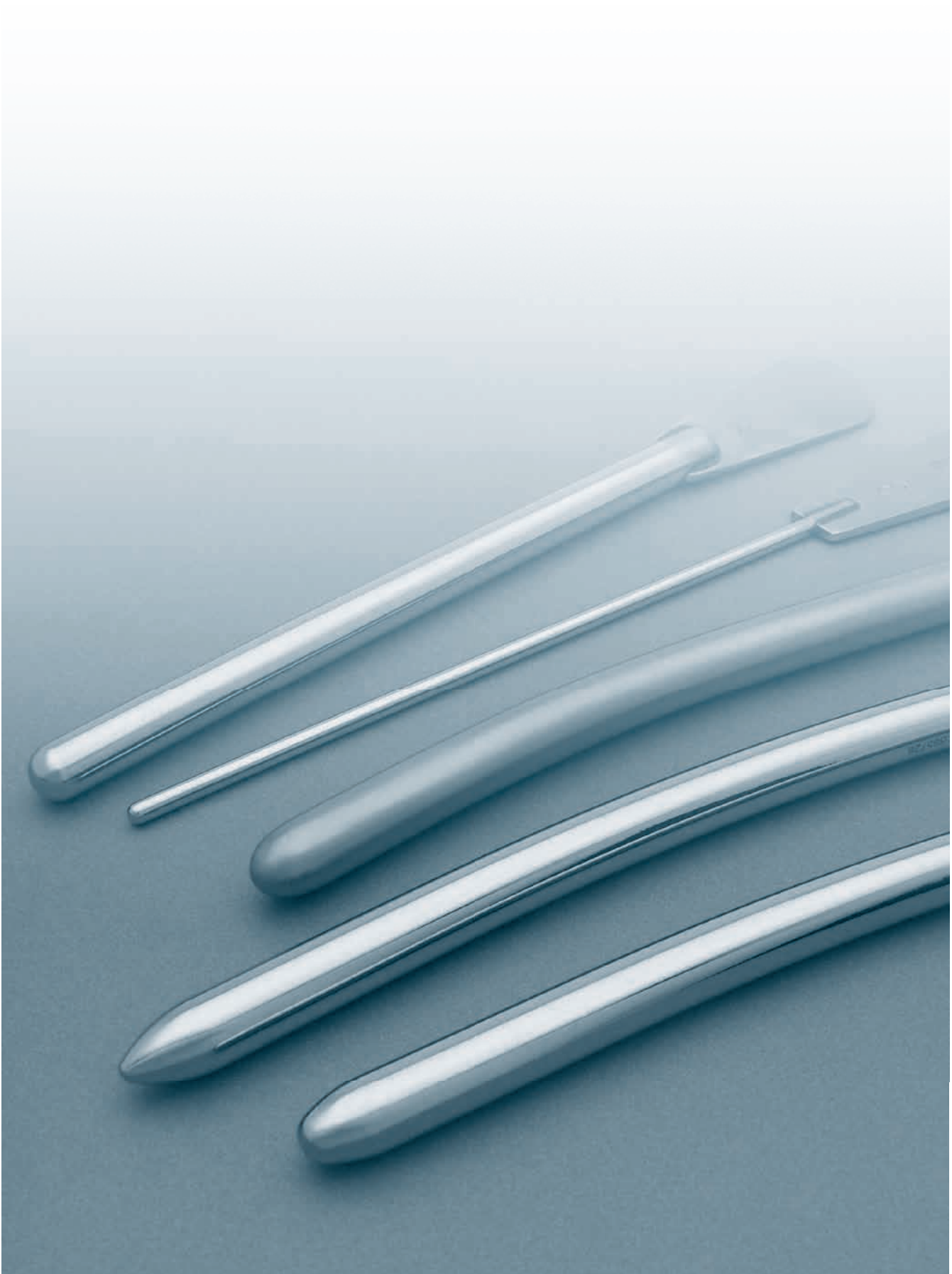



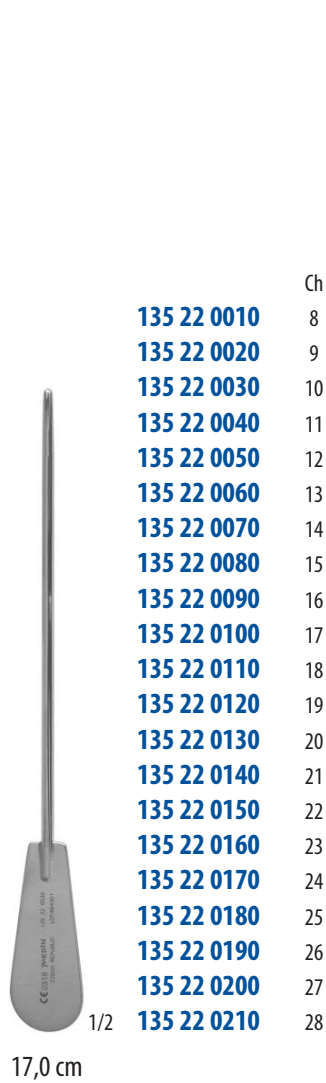



HEGAR
ostrý – sharp
21,0 cm

ostrý – sharp	průměr – diameter
135 27 0400	1,0 mm
135 27 0410	1,5 mm
135 27 0010	2,0 mm
135 27 0020	2,5 mm
135 27 0030	3,0 mm
135 27 0040	3,5 mm
135 27 0050	4,0 mm
135 27 0060	4,5 mm
135 27 0070	5,0 mm
135 27 0080	5,5 mm
135 27 0090	6,0 mm
135 27 0100	6,5 mm
135 27 0110	7,0 mm
135 27 0120	7,5 mm
135 27 0130	8,0 mm
135 27 0140	8,5 mm



HEGAR
tupý – blunt
21,0 cm

tupý – blunt	průměr – diameter
135 27 0401	1,0 mm
135 27 0411	1,5 mm
135 27 0011	2,0 mm
135 27 0021	2,5 mm
135 27 0031	3,0 mm
135 27 0041	3,5 mm
135 27 0051	4,0 mm
135 27 0061	4,5 mm
135 27 0071	5,0 mm
135 27 0081	5,5 mm
135 27 0091	6,0 mm
135 27 0101	6,5 mm
135 27 0111	7,0 mm
135 27 0121	7,5 mm
135 27 0131	8,0 mm
135 27 0141	8,5 mm
135 91 0017	9,0 mm
135 91 0018	9,5 mm
135 91 0019	10,0 mm
135 91 0020	10,5 mm
135 91 0021	11,0 mm
135 91 0022	11,5 mm
135 91 0023	12,0 mm
135 91 0024	12,5 mm
135 91 0025	13,0 mm
135 91 0026	13,5 mm
135 91 0027	14,0 mm
135 91 0028	14,5 mm
135 91 0029	15,0 mm
135 91 0030	15,5 mm
135 91 0031	16,0 mm
135 91 0032	16,5 mm
135 91 0033	17,0 mm
135 91 0034	17,5 mm
135 91 0035	18,0 mm
135 91 0036	18,5 mm
135 91 0037	19,0 mm
135 91 0038	19,5 mm
135 91 0039	20,0 mm
135 91 0040	21,0 mm
135 91 0041	22,0 mm
135 91 0042	23,0 mm
135 91 0043	24,0 mm
135 91 0044	25,0 mm
135 91 0045	26,0 mm
135 91 0046	27,0 mm
135 91 0047	28,0 mm
135 91 0048	29,0 mm
135 91 0049	30,0 mm

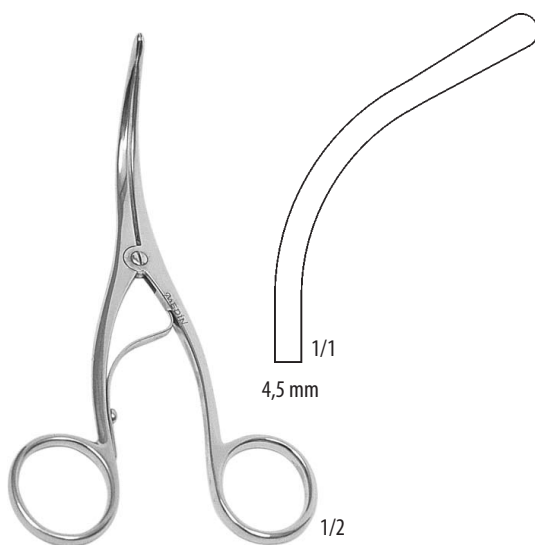

TROUSSEAU
135 34 0010
13,5 cm

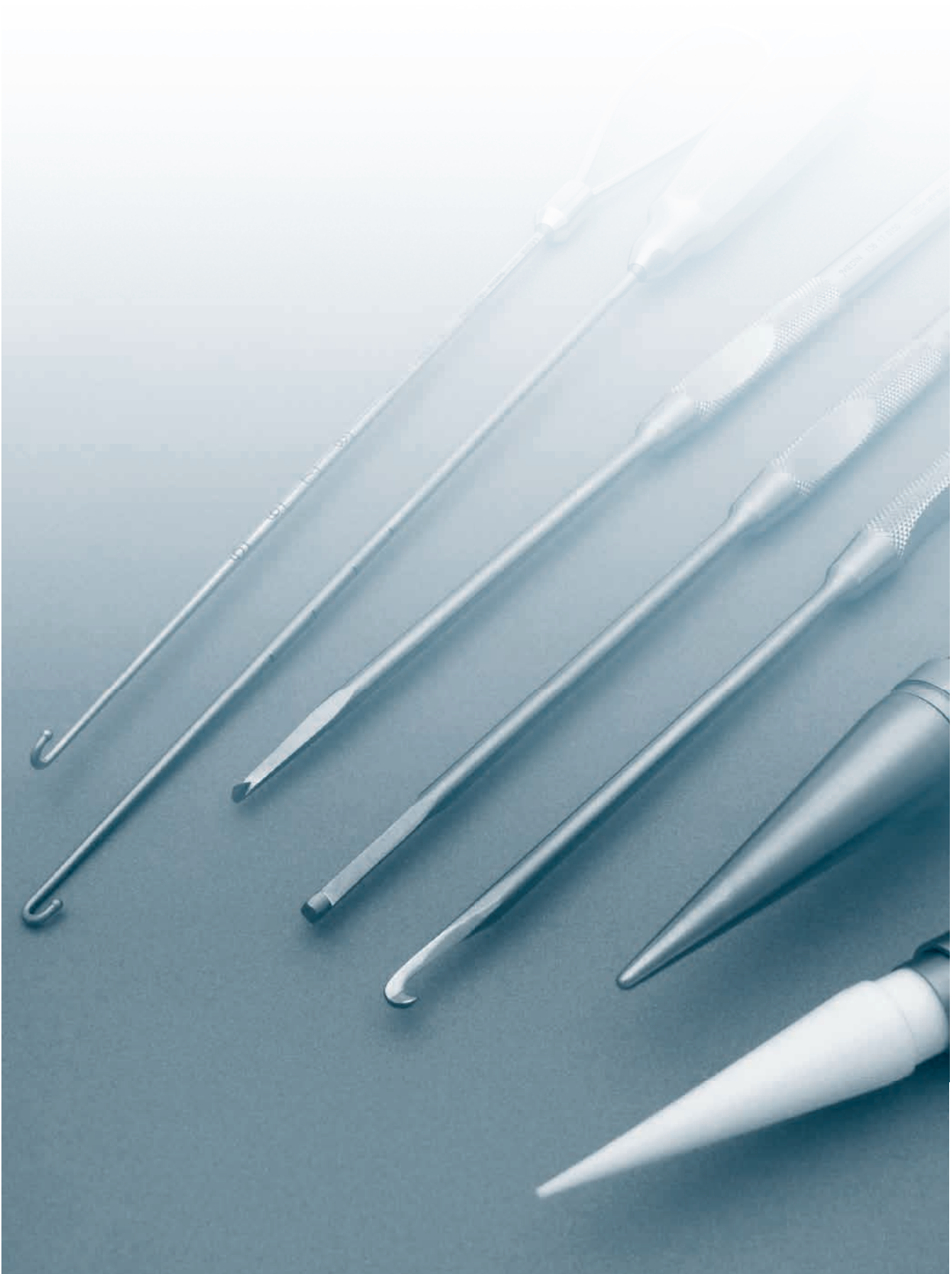



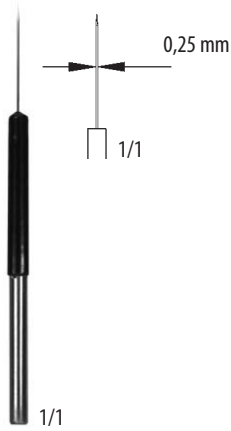

136 08 0510
5,5 cm

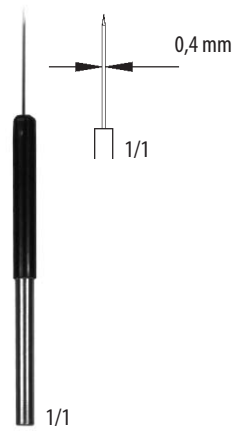

136 08 0520
5,5 cm

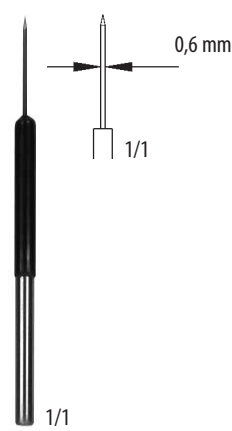

136 08 0530
5,5 cm

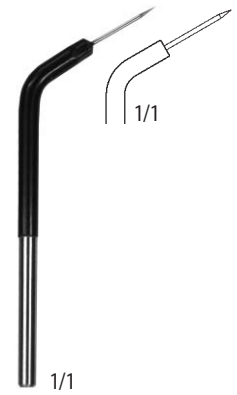

136 08 0540
5,0 cm

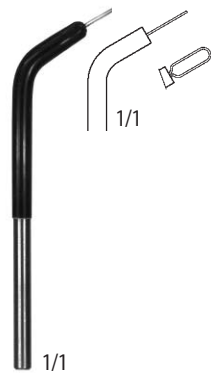

136 08 0550
4,7 cm



136 08 0560
4,7 cm



136 08 0570
4,7 cm



136 08 0580
4,2 cm



136 08 0590
4,4 cm

NÁSTROJE NA PROTĚTÍ VAZU
INSTRUMENTS FOR CUTTING OF LIGAMENT
136 17 0110

sada – set

136 17 0120**136 17 0130****136 17 0140****136 17 0150****136 17 0160**

1/2

POUZDRO VODÍCÍ
GUIDE SLEEVE
136 17 0120

9,3 cm



1/2

ZAVADĚČ POUZDRA VODÍCÍHO
GUIDE FOR SLEEVE
136 17 0130

19,9 cm



1/2

HÁČEK
HOOK
136 17 0140

21,0 cm

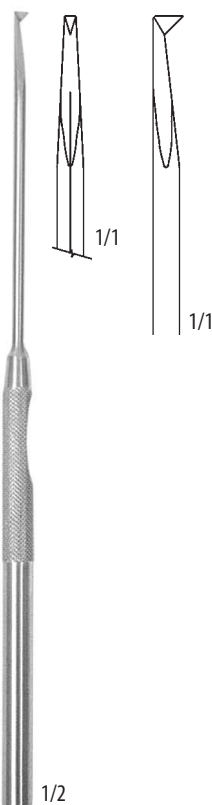

1/2

NŮŽ TROJÚHELNÍKOVÝ
TRIANGULAR KNIFE
136 17 0150

21,0 cm

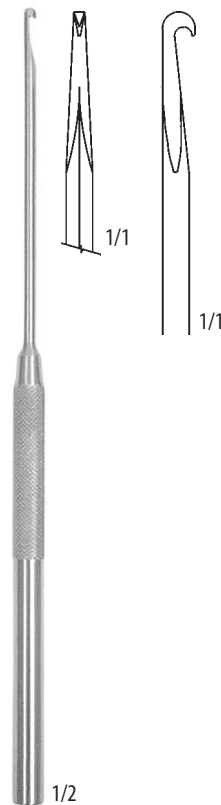

1/2

NŮŽ HÁČKOVÝ
HOOKEK KNIFE
136 17 0160

21,0 cm

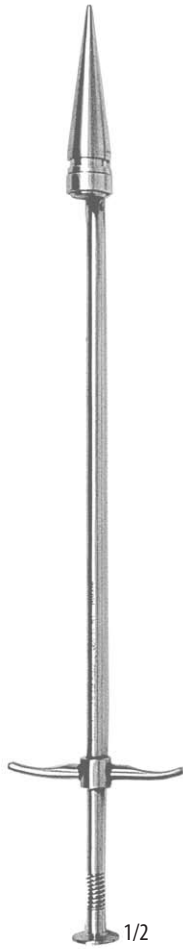

1/2

APLIKÁTOR NA HEMOROIDY
HAEMORRHODIAL APPLICATOR

136 19 0010

24,6 cm



1/2

APLIKÁTOR NA HEMOROIDY
HAEMORRHODIAL APPLICATOR

136 19 0020

21,0 cm



1/1

GUMOVÝ O-KROUŽEK K APLIKÁTORU
GUM O-RING FOR APPLICATOR

115 91 0578

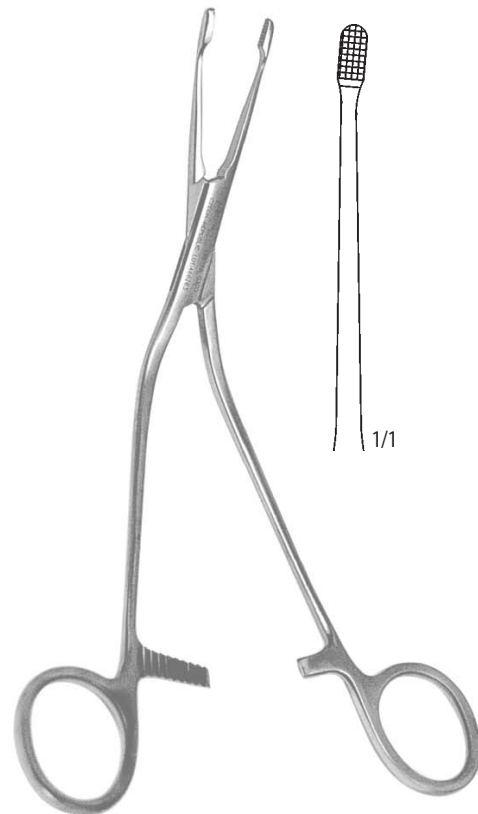

1/1

1/2

SVORKA NA HEMOROIDY
HAEMORRHODIAL FORCEPS

115 19 0300

21,2 cm



136 27 0310
26,5 cm



136 27 0311
26,5 cm



TOULEC NA PINZETY S PODSTAVCEM
 TWEEZER QUIVER WITH STAND

136 39 0050

průměr × výška
 diameter × height
 7,0 × 11,0 cm



TOULEC NA KLEŠTĚ S PODSTAVCEM
 FORCEPS QUIVER WITH STAND

136 39 0060

průměr × výška
 diameter × height
 7,0 × 20,0 cm



TOULEC NA PINZETY S PODSTAVCEM
 TWEEZER QUIVER WITH STAND

136 39 0070

průměr × výška
 diameter × height
 5,0 × 9,0 cm



průměr × výška
 diameter × height

136 91 0072 3,0 × 9,0 cm
136 91 0070 5,0 × 10,0 cm
136 91 0073 5,0 × 13,0 cm
136 91 0074 5,0 × 17,5 cm
136 91 0075 7,5 × 10,0 cm
136 91 0076 7,5 × 13,0 cm
136 91 0071 7,5 × 17,5 cm



průměr × výška
diameter × height

136 91 0077	0,05 l	4,0 × 1,9 cm
136 91 0078	0,07 l	6,1 × 3,0 cm
136 91 0079	0,14 l	8,0 × 4,0 cm
136 91 0080	0,35 l	11,6 × 5,0 cm
136 91 0081	0,45 l	12,8 × 5,5 cm
136 91 0082	0,70 l	14,7 × 6,5 cm



136 91 0083	0,25 l
136 91 0084	0,50 l
136 91 0085	1,00 l
136 91 0086	2,00 l

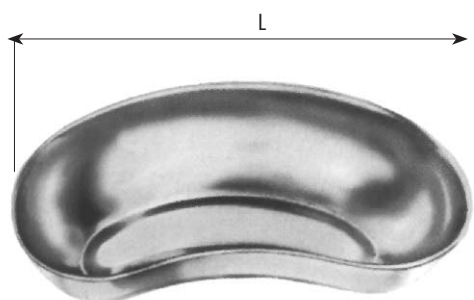

	L
136 91 0087	17,0 cm
136 91 0088	25,0 cm
136 91 0089	27,5 cm

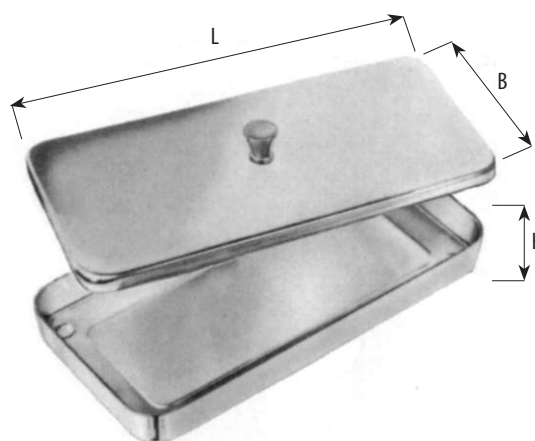

	L	B	H
136 91 0036	16,5	9,0	3,5 cm
136 91 0037	20,0	10,0	5,0 cm
136 91 0038	22,0	15,0	5,0 cm
136 91 0039	26,0	15,0	5,0 cm
136 91 0040	30,5	20,5	5,0 cm

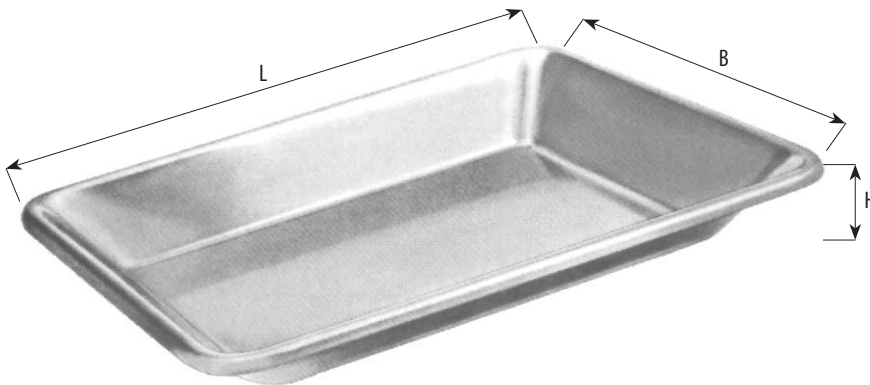

	L	B	H
136 91 0097	23,0	15,5	3,0
136 91 0098	30,0	17,5	3,0
136 91 0099	30,0	17,5	4,0
136 91 0100	35,0	24,0	3,6
136 91 0101	40,0	30,0	5,0

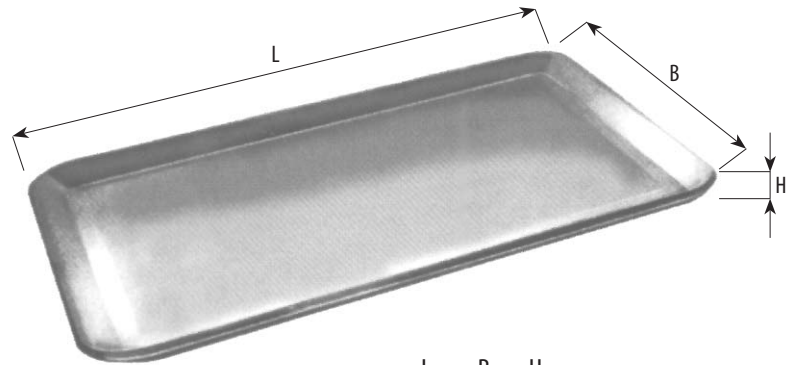

	L	B	H
136 91 0102	21,0	16,0	1,0
136 91 0103	24,0	18,0	1,0
136 91 0104	31,0	15,0	1,0
136 91 0105	31,0	21,0	1,0
136 91 0106	35,0	24,0	1,0
136 91 0107	40,0	27,0	2,0
136 91 0108	42,0	28,0	1,0



	průměr × výška diameter × height
136 91 0109	0,75 l 16,5 × 5,5 cm
136 91 0110	1,00 l 17,5 × 7,0 cm
136 91 0111	2,00 l 22,5 × 10,0 cm
136 91 0113	2,75 l 24,0 × 9,5 cm
136 91 0114	4,00 l 26,0 × 12,0 cm
136 91 0115	5,50 l 31,5 × 10,5 cm
136 91 0116	8,00 l 32,5 × 13,5 cm
136 91 0117	12,00 l 36,0 × 16,5 cm
136 91 0118	14,00 l 40,5 × 15,0 cm



136 91 0091
VNITŘNÍ KRABÍČKA
INNER BOX

136 91 0090
průměr – diameter
6,5 cm

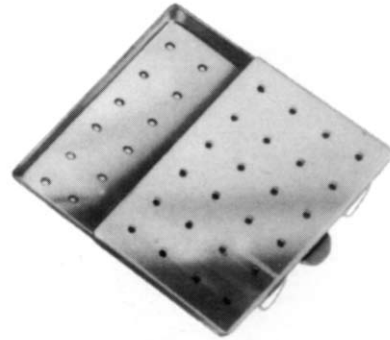

136 91 0092 5,0 × 2,5 × 0,45 cm

136 91 0093 6,5 × 4,2 × 8,0 cm

136 91 0094 7,5 × 2,5 × 0,45 cm



SAUERBRUCH
136 91 0095
21,0 × 12,5 × 1,7 cm



136 91 0096
15,0 × 9,5 × 1,3 cm



MAYO
136 91 0128
14,0 cm

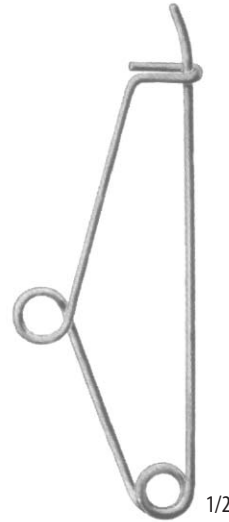

MAYO
136 91 0129
14,0 cm







139 01 0090

20,2 × 11,5 × 2 cm

SKALPEL S PLOCHÝM DRŽADLEM BŘÍŠKATÝ – NEREZ
 SKALPEL S PLOCHÝM DRŽADLEM HROTNATÝ – NEREZ
 NŮŽKY CHIRURGICKÉ ROVNÉ HROTNATOTUPÉ
 PINZETA ANATOMICKÁ ROVNÁ
 ROCHESTER-PEAN SVORKA NA CÉVY ROVNÁ
 PÁTRADLO PALIČKOVÉ S DLÁTKEM

OPERATING KNIFE
 OPERATING KNIFE
 STANDARD OPERATING SCISSORS
 DRESSING FORCEPS
 ROCHESTER-PEAN ARTERY FORCEPS
 PROBE OLIVE WITH CHISEL

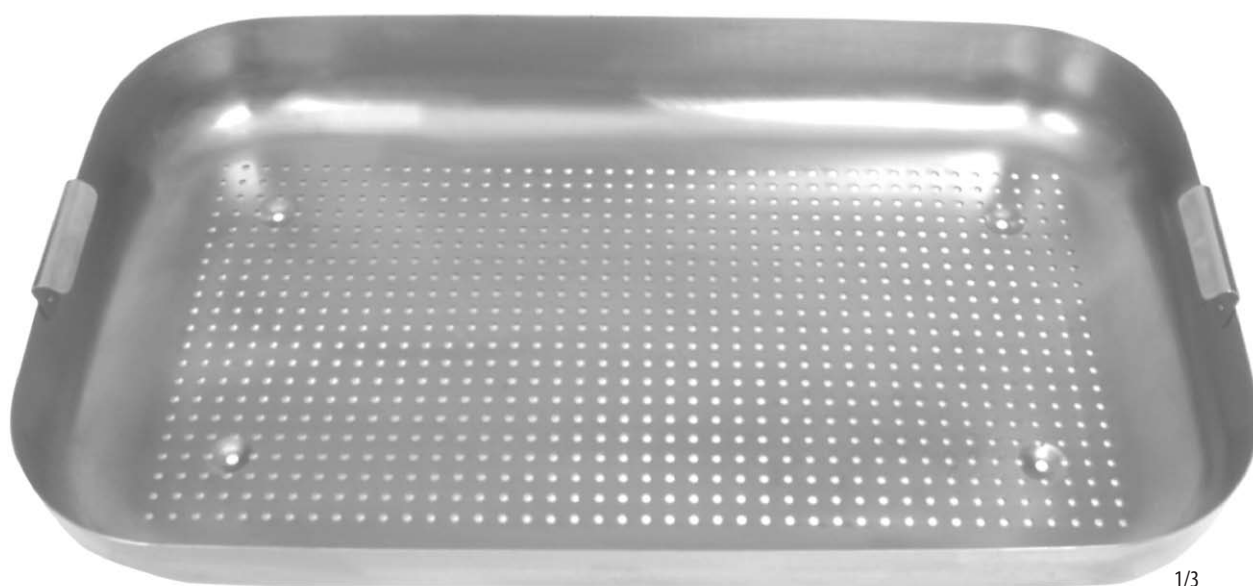
112 08 0080
112 08 0160
113 08 0120
114 08 1350
115 08 0220
133 08 0100



1/3

139 39 0010

Fig.1

50,0 × 30,0 × 3 cm

139 39 0040

Fig.4

50,0 × 30,0 × 6 cm



1/3

139 39 0020

Fig.2

30,0 × 23,0 × 3 cm



1/3

139 39 0030

Fig.3

30,0 × 15,0 × 3 cm







1/2

SOUPRAVA PRO ODBĚR SPUTA
TEST TUBE FOR SPUTUM
285 753 54 7010

Ø 26 × 62 mm

 materiál: zkumavka PP, víčko PE
 sterilní, jednorázová
 400 ks v kartonu

 material: test tube PP, lid PE
 sterile, single-use
 400 pcs in carton

1/2

SOUPRAVA PRO ODBĚR STOLICE
SET FOR STOOL TAKING
285 753 54 7011

Ø 26 × 62 mm

 materiál: zkumavka PP, víčko PE
 sterilní, jednorázová
 400 ks v kartonu

 material: test tube PP, lid PE
 sterile, single-use
 400 pcs in carton

1/2

SOUPRAVA NA ODBĚR KRVE A MOČE
SET OF BLOOD AND URINE TAKING
285 753 54 7012

Ø 16 × 100 mm

 materiál: zkumavka PP, víčko PE
 sterilní

50 v lepenkové skládačce, 400 ks v kartonu

 material: test tube PP, lid PE
 sterile

50 in cardboard box, 400 pcs in carton



1/2

ZKUMAVKA NA MLÉKO S VÍČKEM
TEST TUBE FOR MILK WITH LID
285 776 54 9374

Ø 30 × 65 mm

 materiál: zkumavka PP, víčko PE
 500 ks v PE sáčku a kartonu
 víčka zvlášť v PE sáčku

 material: test tube PP, lid PE
 500 pcs in PE bag and carton
 lids separately in PE bag

1/2

ZKUMAVKA NA MLÉKO S VÍČKEM
TEST TUBE FOR MILK WITH LID
285 776 54 9375

Ø 30 × 65 mm

 materiál: zkumavka PP, víčko PE
 500 ks v PE sáčku a kartonu
 víčka zvlášť v PE sáčku

 material: test tube PP, lid PE
 500 pcs in PE bag and carton
 lids separately in PE bag

1/2

VÍČKO KE ZKUMAVCE NA MLÉKO
LID FOR TEST TUBE FOR MILK
285 943 94 0123

Ø 30 mm

 materiál: PE
 150 ks v PE sáčku
 material: PE
 150 pcs in PE bag

1/2

VÍČKO KE ZKUMAVCE NA MLÉKO PLOCHÉ
LID FOR TEST TUBE FOR MILK FLAT
285 943 94 0066

Ø 30 mm

 materiál: PE
 150 ks v PE sáčku
 material: PE
 150 pcs in PE bag



1/2

ZKUMAVKA JEDNORÁZOVÁ
TEST TUBE, SINGLE USE

285 772 54 9235

Ø 12,5 × 75 mm

materiál: PS

100 ks v PE sáčku, 2000 ks v kartonu

material: PS

100 pcs in PE bag, 2000 pcs in carton



1/2

ZKUMAVKA PRO STANDARDIZACI
TEST TUBE FOR STANDARDIZATION

285 775 54 9233

Ø 18 × 95 mm

materiál: PS

50 ks v PE sáčku, 1000 ks v kartonu

material: PS

50 pcs in PE bag, 1000 pcs in carton



1/2

ZKUMAVKA PRO ANALYZÁTOR S ROVNÝM OKRAJEM
TEST TUBE FOR ANALYZATOR WITH FLAT BORDER

285 770 10 0102

Ø 17 × 38 mm

materiál: PS

200 ks v PE sáčku, 2000 ks v kartonu

material: PS

200 pcs in PE bag, 2000 pcs in carton



1/2

NÁDOBKA NA PŘÍPRAVU VZORKŮ
SMALL CONTAINER FOR SAMPLE PREPARATION

285 770 10 0110

Ø 42 × 35 mm

materiál: PS

40 ks v PE sáčku, 800 ks v kartonu

material: PS

40 pcs in PE bag, 800 pcs in carton



1/2

POHÁR NA MOČ 250 ml
GLASS FOR URINE 250 ml

397 238 10 2000

Ø 71 × 157 mm

materiál: PS

20 ks v kartonu

material: PS

20 pcs in carton



1/2

POHÁR NA MOČ 100 ml
GLASS FOR URINE 100 ml

397 238 10 5000

Ø 70 × 140 mm

materiál: PS

20 ks v kartonu

material: PS

20 pcs in carton



1/2

285 799 54 4900

KLÍČKA ODMĚRNÁ 1 µl	195 mm	materiál: PP	sterilní	20 ks v PE sáčku, 4000 ks v kartonu
MEASURING LOOP 1 µl	195 mm	material: PP	sterile	20 pcs in PE bag, 4000 pcs in carton



1/2

285 799 54 4901

KLÍČKA ODMĚRNÁ 10 µl	195 mm	materiál: PP	sterilní	20 ks v PE sáčku, 4000 ks v kartonu
MEASURING LOOP 10 µl	195 mm	material: PP	sterile	20 pcs in PE bag, 4000 pcs in carton

ROUŠKA PRO DÝCHÁNÍ Z PLIC DO PLIC
MASK FOR BREATHING

285 553 54 6521

balení 1 ks v PE sáčku, 250 ks v kartonu
packing 1 pc in PE bag, 250 pcs in carton



Materiál: všechny díly roušky jsou vyrobeny ze zdravotně nezávadných materiálů

Použití: – rouška pro dýchání z plic do plic slouží jako ochranná pomůcka pro poskytování první pomoci při zástavě dechu
– rouška chrání před infekcí, zejména v souvislosti s možností přenosu viru HBV a HIV, který způsobuje onemocnění AIDS

Funkce: pracuje na principu jednocestného ventilu

Material: all parts of the mask for breathing are made of materials that do not affect health.

Using: The mask for breathing from lungs to lungs has a protective function when providing the first aid during breath failure.
The mask prevents from infections, mainly in connection with the possibility of HBV and HIV virus transfer. Virus HIV causes the AIDS illness.

Function: it works on the principle of one-way valve.

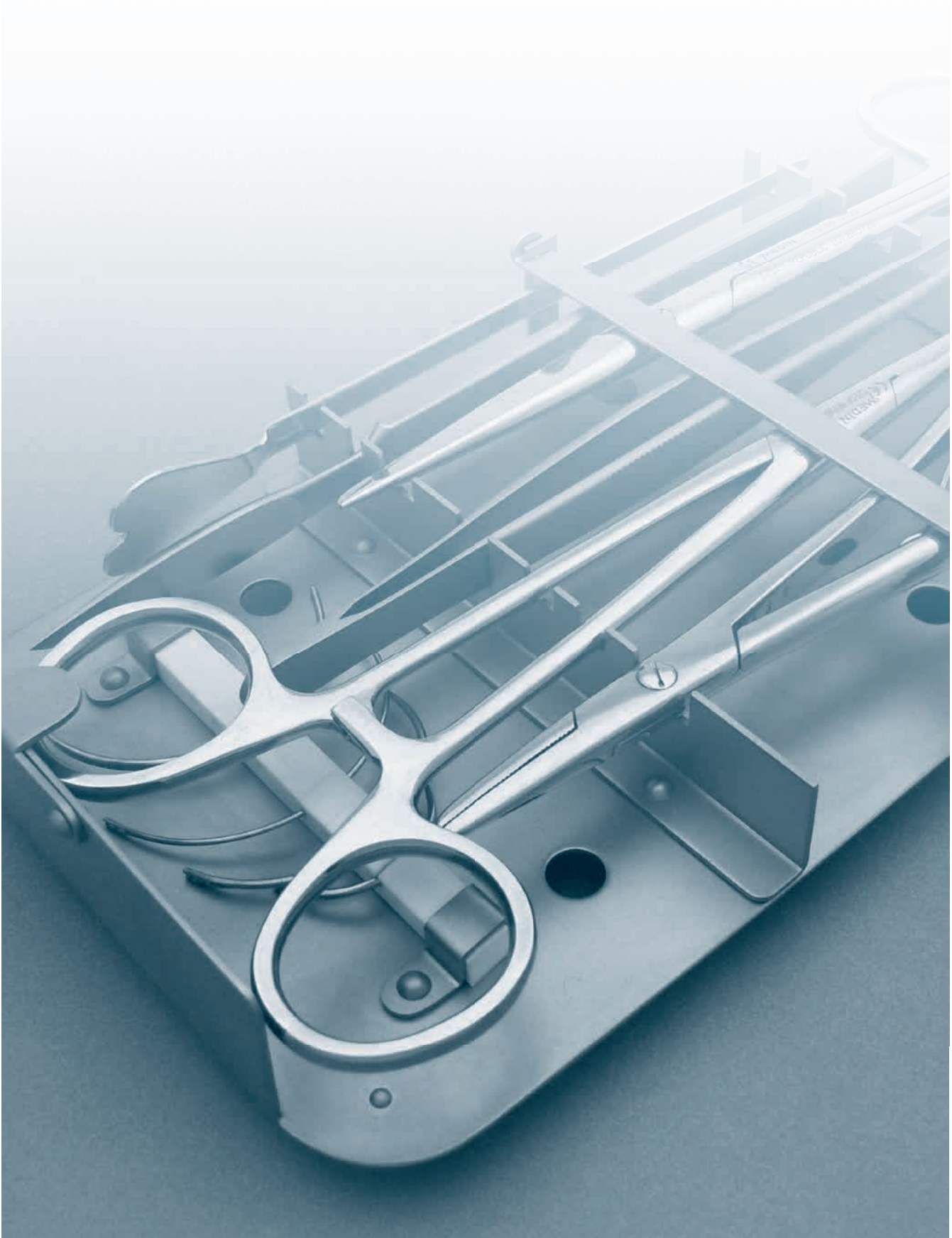

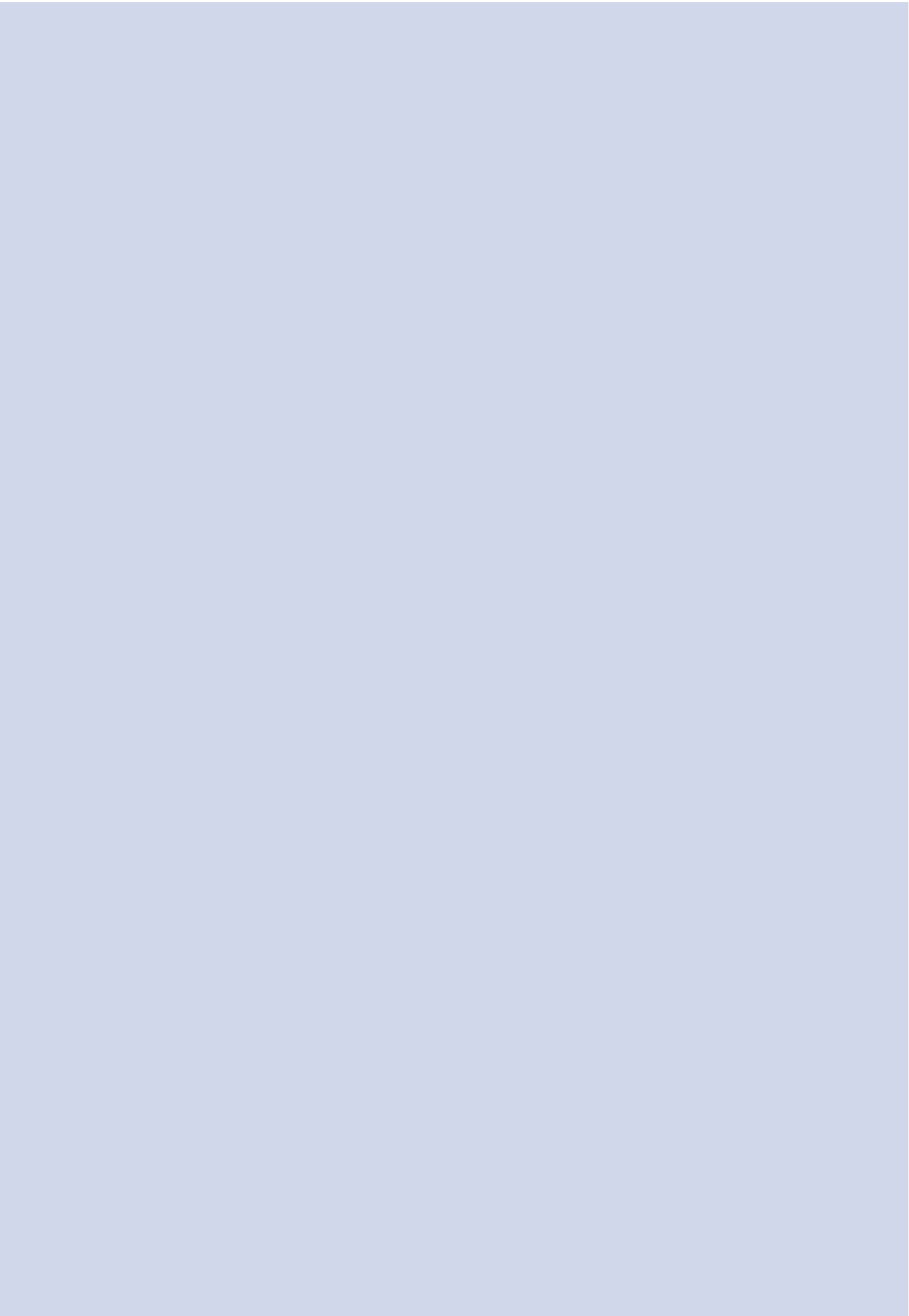

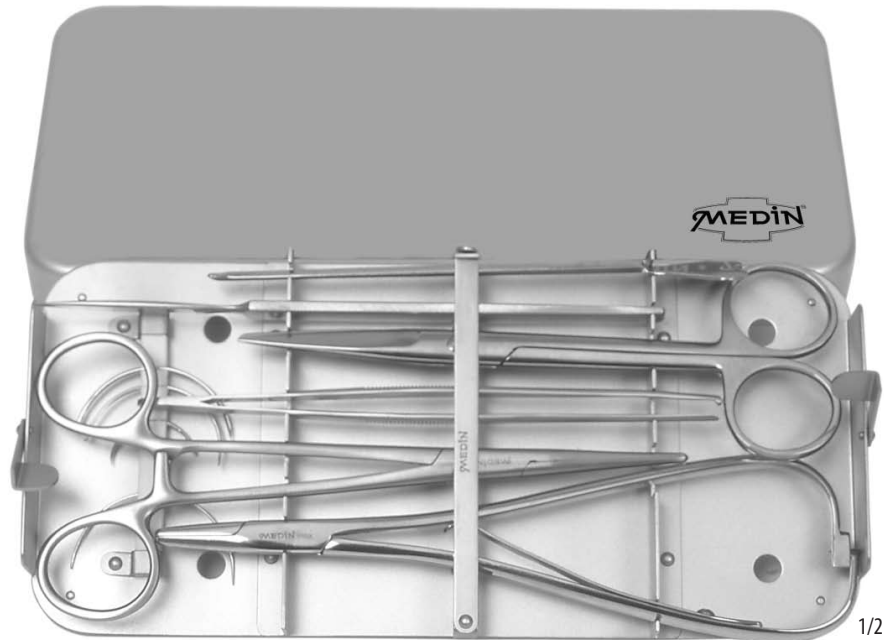
571 00 8800

22,0 × 10,5 × 5,5 cm

SKALPEL HROTNATÝ
 NŮŽKY CHIRURGICKÉ ROVNÉ
 PINZETA CHIRURGICKÁ
 SVORKA NA CÉVY ROVNÁ
 JEHLA ŠÍCÍ 0,8 × 65 mm
 JEHLA ŠÍCÍ 1,2 × 35 mm
 JEHLA ŠÍCÍ 1,1 × 56 mm
 JEHLA ŠÍCÍ 1,4 × 60 mm
 JEHELEC MATHIEU
 PÁTRADLO ŽLÁBKOVÉ
 KRABICE

OPERATING KNIFE
 SURGICAL SCISSORS STRAIGHT
 SURGICAL FORCEPS
 ARTERY FORCEPS STRAIGHT
 NEEDLE
 NEEDLE
 NEEDLE
 NEEDLE
 NEEDLE HOLDER MATHIEU
 PROBE
 BOX

112 08 0180
113 08 0120
114 08 0381
115 08 0231
132 02 0700
132 02 0406
132 02 0220
132 02 0401
132 06 0220
133 08 0090
139 50 0300

číslo – number	název	item	strana – page
111	DIAGNOSTIKA	DIAGNOSTIC	
111 01 0010	Naběračka pro anatomii; 100 cm ³	Anatomy ladle; 100 cm ³	22
111 91 0001	McIntosh laryngoskop komplet	McIntosh laryngoscopes complete	11
111 91 0002	McIntosh laryngoskop komplet	McIntosh laryngoscopes complete	11
111 91 0003	McIntosh laryngoskopová lžice fig.0; 5,5 cm	McIntosh blades fig.0; 5,5 cm	11
111 91 0004	McIntosh laryngoskopová lžice fig.1; 7,5 cm	McIntosh blades fig.1; 7,5 cm	11
111 91 0005	McIntosh laryngoskopová lžice fig.2; 9,0 cm	McIntosh blades fig.2; 9,0 cm	11
111 91 0006	McIntosh laryngoskopová lžice fig.3; 11,0 cm	McIntosh blades fig.3; 11,0 cm	11
111 91 0007	McIntosh laryngoskopová lžice fig.4; 13,5 cm	McIntosh blades fig.4; 13,5 cm	11
111 91 0008	Foregger (Wisconsin) laryngoskop komplet	Foregger (Wisconsin) laryngoscopes complete	12
111 91 0009	Foregger (Wisconsin) laryngoskop komplet	Foregger (Wisconsin) laryngoscopes complete	12
111 91 0010	Foregger laryngoskopová lžice fig.0; 7,0 cm	Foregger blades fig.0; 7,0 cm	12
111 91 0011	Foregger laryngoskopová lžice fig.1; 9,5 cm	Foregger blades fig.1; 9,5 cm	12
111 91 0012	Foregger laryngoskopová lžice fig.2; 11,0 cm	Foregger blades fig.2; 11,0 cm	12
111 91 0013	Foregger laryngoskopová lžice fig.3; 14,0 cm	Foregger blades fig.3; 14,0 cm	12
111 91 0014	Foregger laryngoskopová lžice fig.4; 17,0 cm	Foregger blades fig.4; 17,0 cm	12
111 91 0015	Miller laryngoskop komplet	Miller laryngoscopes complete	13
111 91 0016	Miller laryngoskop komplet	Miller laryngoscopes complete	13
111 91 0017	Miller laryngoskopová lžice fig.0; 5,5 cm	Miller blades fig.0; 5,5 cm	13
111 91 0018	Miller laryngoskopová lžice fig.1; 8,0 cm	Miller blades fig.1; 8,0 cm	13
111 91 0019	Miller laryngoskopová lžice fig.2; 13,0 cm	Miller blades fig.2; 13,0 cm	13
111 91 0020	Miller laryngoskopová lžice fig.3; 17,0 cm	Miller blades fig.3; 17,0 cm	13
111 91 0021	Miller laryngoskopová lžice fig.4; 18,0 cm	Miller blades fig.4; 18,0 cm	13
111 91 0022	Držadlo s baterií; 19,0 cm	Battery handle; 19,0 cm	14
111 91 0023	Držadlo s baterií; 28,0 cm	Battery handle; 28,0 cm	14
111 91 0024	Držadlo s baterií; 37,0 cm	Battery handle; 37,0 cm	14
111 91 0025	Akumulátor do držadla	Accumulator insert for battery handle	14
111 91 0026	Žárovka velká do laryngoskopu fig.2-4	Laryngoscope bulb large size fig.2-4	14
111 91 0027	Žárovka malá do laryngoskopu fig.0-1	Laryngoscope bulb small size fig.0-1	14
111 91 0028	McIntosh laryngoskop se studeným světlem komplet	McIntosh fibre optic laryngoscopes complete	15
111 91 0029	McIntosh laryngoskop se studeným světlem komplet	McIntosh fibre optic laryngoscopes complete	15
111 91 0030	McIntosh laryngoskop. lžice (studené světlo) fig.0; 5,5 cm	McIntosh fibre optic blades fig.0; 5,5 cm	15
111 91 0031	McIntosh laryngoskop. lžice (studené světlo) fig.1; 7,0 cm	McIntosh fibre optic blades fig.1; 7,0 cm	15
111 91 0032	McIntosh laryngoskop. lžice (studené světlo) fig.2; 8,0 cm	McIntosh fibre optic blades fig.2; 8,0 cm	15
111 91 0033	McIntosh laryngoskop. lžice (studené světlo) fig.3; 10,5 cm	McIntosh fibre optic blades fig.3; 10,5 cm	15
111 91 0034	McIntosh laryngoskop. lžice (studené světlo) fig.4; 13,0 cm	McIntosh fibre optic blades fig.4; 13,0 cm	15
111 91 0035	Foregger laryngoskop se studeným světlem komplet	Foregger fibre optic laryngoscope complete	16
111 91 0036	Foregger laryngoskop se studeným světlem komplet	Foregger fibre optic laryngoscope complete	16
111 91 0037	Foregger laryngoskop. lžice (studené světlo) fig.0; 7,0 cm	Foregger fibre optic blades fig.0; 7,0 cm	16
111 91 0038	Foregger laryngoskop. lžice (studené světlo) fig.1; 9,5 cm	Foregger fibre optic blades fig.1; 9,5 cm	16
111 91 0039	Foregger laryngoskop. lžice (studené světlo) fig.2; 11,0 cm	Foregger fibre optic blades fig.2; 11,0 cm	16
111 91 0040	Foregger laryngoskop. lžice (studené světlo) fig.3; 14,0 cm	Foregger fibre optic blades fig.3; 14,0 cm	16
111 91 0041	Foregger laryngoskop. lžice (studené světlo) fig.4; 17,0 cm	Foregger fibre optic blades fig.4; 17,0 cm	16
111 91 0042	Miller laryngoskop se studeným světlem komplet	Miller fibre optic laryngoscopes	17
111 91 0043	Miller laryngoskop se studeným světlem komplet	Miller fibre optic laryngoscopes	17
111 91 0044	Miller laryngoskop. lžice (studené světlo) fig.0; 5,5 cm	Miller fibre optic blades fig.0; 5,5 cm	17
111 91 0045	Miller laryngoskop. lžice (studené světlo) fig.1; 8,0 cm	Miller fibre optic blades fig.1; 8,0 cm	17
111 91 0046	Miller laryngoskop. lžice (studené světlo) fig.2; 13,0 cm	Miller fibre optic blades fig.2; 13,0 cm	17
111 91 0047	Miller laryngoskop. lžice (studené světlo) fig.3; 17,0 cm	Miller fibre optic blades fig.3; 17,0 cm	17
111 91 0048	Miller laryngoskop. lžice (studené světlo) fig.4; 18,0 cm	Miller fibre optic blades fig.4; 18,0 cm	17
111 91 0049	Držadlo s baterií (studené světlo); 3,0 cm	Handle fibre optic battery; 3,0 cm	18
111 91 0050	Držadlo s baterií (studené světlo); 2,0 cm	Handle fibre optic battery; 2,0 cm	18
111 91 0051	Žárovka halogenová 2,5 V (stud. světlo)	Bulb halogen 2,5 V (fibre optic)	18
111 91 0052	Žárovka kryptonová 2,5 V (stud. světlo)	Bulb krypton 2,5 V (fibre optic)	18
111 91 0066	Lampa čelní 220 V	Head light 220 V	19
111 91 0067	Náhradní žárovka	Spare lamp	19
111 91 0068	Zrcadlo čelní s krytem; 9,0 cm	Head mirror with cover; 9,0 cm	19
111 91 0069	Zrcadlo čelní s krytem; 10,0 cm	Head mirror with cover; 10,0 cm	19
111 91 0070	Clar 55 čelní lampa 6 voltů	Clar 55 head lamp 6 volt	20
111 91 0071	Clar standard čelní lampa 6 voltů	Clar head lamp	20
111 91 0072	Buck kladívko; 18,0 cm	Buck percussion hammer; 18,0 cm	21
111 91 0073	Babinsky kladívko; 4,0 cm; 22,0 cm	Babinsky percussion hammer; 4,0 cm; 22,0 cm	21
111 91 0074	Rabiner kladívko; 23,0 cm	Rabiner percussion hammer; 23,0 cm	21
111 91 0075	Taylor reflexní kladívko; 18,0 cm	Taylor neurolog. reflex hammer; 18,0 cm	21

číslo – number	název	item	strana – page
111 91 0076	Taylor reflexní kladívko; 20,0 cm	Taylor neurolog. reflex hammer; 20,0 cm	21
111 91 0077	Troemner kladívko; 24,0 cm	Troemner percussion hammer; 24,0 cm	22
111 91 0078	Déjerine kladívko; 20,0 cm	Dejerine percussion hammer; 20,0 cm	22
111 91 0079	Déjerine kladívko s jehlou; 20,0 cm	Dejerine percussion hammer with needle; 20,0 cm	22
111 91 0080	Berliner reflexní kladívko; 20,0 cm	Berliner neurolog. reflex hammer; 20,0 cm	22
111 91 0081	Měřítko; 15,0 cm	Measuring instrument; 15,0 cm	23
111 91 0082	Měřítko; 20,0 cm	Measuring instrument; 20,0 cm	23
111 91 0083	Měřítko; kovové 30,0 cm	Measuring instrument; metal 30,0 cm	23
111 91 0084	Měřítko; 50,0 cm	Measuring instrument; 50,0 cm	23
111 91 0085	Měřítko; 150,0 cm	Measuring instrument; 150,0 cm	23
111 91 0086	Měřítko x-ray; 50,0 cm	Measuring instrument x-ray; 50,0 cm	23
111 91 0088	Moeltgen goniometr	Moeltgen goniometer	23
111 91 0090	Collin dynamometr pro dospělé	Collin dynamometer for adults	23
111 91 0091	Collin dynamometr pro děti	Collin dynamometer for children	23
112	REZNÉ NÁSTROJE	CUTTING INSTRUMENTS	
112 01 0030	Nůž na chrupavku-nerez; 20,5 cm	Cartilage knife; 20,5 cm	42
112 01 0210	Virchow nůž pitevní na mozek dvojbřitý; 28,6 cm	Virchow post mortem knife; 28,6 cm	42
112 01 0240	Nůž pitevní; 24,0 cm	Post mortem knife; 24,0 cm	42
112 01 0250	Nůž pitevní hrotnatý; 25,5 cm	Post mortem knife; 25,5 cm	42
112 02 0100	Jehla preparační fig.1; 13,6 cm	Dissecting needle fig.1; 13,6 cm	43
112 02 0110	Jehla preparační fig.2; 13,4 cm	Dissecting needle fig.2; 13,4 cm	43
112 02 0300	Jehla preparační; 13,6 cm	Dissecting needle; 13,6 cm	43
112 02 0410	Klička na výtěry; 7,0 cm	Wire loop for microscopy; 7,0 cm	43
112 05 0010	Reiner nůž na sádrové obvazy; 25,5 cm	Reiner plaster knife; 25,5 cm	41
112 08 0060	Skalpel s plochým držadlem bříškatý-nerez; 2,0 cm; 14,0 cm	Operating knife fig.1; 2,0 cm; 14,0 cm	30
112 08 0070	Skalpel s plochým držadlem bříškatý-nerez; 3,0 cm; 15,3 cm	Operating knife fig.5; 3,0 cm; 15,3 cm	30
112 08 0080	Skalpel s plochým držadlem bříškatý-nerez; 4,0 cm; 16,3 cm	Operating knife fig.7; 4,0 cm; 16,3 cm	30, 441
112 08 0090	Skalpel s plochým držadlem bříškatý-nerez; 5,0 cm; 17,3 cm	Operating knife fig.9; 5,0 cm; 17,3 cm	30
112 08 0160	Skalpel s plochým držadlem hrotnatý-nerez; 2,0 cm; 14,0 cm	Operating knife fig.10; 2,0 cm; 14,0 cm	30, 441
112 08 0170	Skalpel s plochým držadlem hrotnatý-nerez; 3,0 cm; 15,3 cm	Operating knife fig.14; 3,0 cm; 15,3 cm	30
112 08 0180	Skalpel s plochým držadlem hrotnatý-nerez; 4,0 cm; 16,3 cm	Operating knife fig.16; 4,0 cm; 16,3 cm	30, 451
112 08 0190	Skalpel s plochým držadlem hrotnatý-nerez; 5,0 cm; 17,3 cm	Operating knife fig.18; 5,0 cm; 17,3 cm	30
112 08 0260	Skalpel s dlouhým krčkem dvojbřitý; 17,2 cm	Operating knife; 17,2 cm	31
112 08 0270	Skalpel s dlouhým krčkem bříškatý - nerez; 17,5 cm	Operating knife; 17,5 cm	31
112 08 0280	Skalpel s dlouhým krčkem hrotnatý rovný - nerez; 17,5 cm	Operating knife; 17,5 cm	31
112 08 0290	Skalpel s dlouhým krčkem hrotnatý zahnutý - nerez; 17,5 cm	Operating knife; 17,5 cm	31
112 08 0350	Skalpel s hranatým držadlem hrotnatý; 4,0 cm	Operating knife; 4,0 cm	31
112 08 0650	Držátko skalpelových čepelek ploché; 14,0 cm	Scalpel handle; 14,0 cm	28
112 08 0696	Držátko skalpelových čepelek; 15,0 cm	Scalpel handle; 15,0 cm	28
112 08 0700	Klíček utahovací k držákům skalpelových čepelek; 8,0 cm	Spanner for scalpel blade holder; 8,0 cm	28
112 08 0710	Nůž resekční bříškatý; 17,0 cm	Resection knife; 17,0 cm	31
112 08 0730	Langenbeck nůž amputační bříškatý; čepel 11,5 cm; 24,0 cm	Langenbeck amputating knife; blade 11,5 cm; 24,0 cm	41
112 08 0740	Collin nůž amputační hrotnatý; čepel 16,0 cm; 29,0 cm	Collin amputating knife; blade 16,0 cm; 29,0 cm	41
112 08 0770	Collin nůž amputační hrotnatý; čepel 22,0 cm; 35,0cm	Collin amputating knife; blade 22,0 cm; 35,0cm	41
112 08 1090	Nůž k protínání příčného vazů zápěstního; 22 cm	Knife for slashing carpal ligament; 22 cm	31
112 08 2030	Jehla epilační válcová 0,09 mm; 3,0 cm	Depilation needle; 0,09 mm; 3,0 cm	29
112 08 2040	Jehla epilační válcová 0,12 mm; 3,0 cm	Depilation needle; 0,12 mm; 3,0 cm	29
112 08 2070	Jehla epilační válcová 0,15 mm; 3,0 cm	Depilation needle; 0,15 mm; 3,0 cm	29
112 08 2080	Jehla epilační kuželová 0,10 mm; 3,1 cm	Depilation needle - conical; 0,10 mm; 3,1 cm	29
112 08 2090	Jehla epilační kuželová 0,09 mm; 3,1 cm	Depilation needle - conical; 0,09 mm; 3,1 cm	29
112 08 2100	Jehla epilační kuželová 0,12 mm; 3,1 cm	Depilation needle - conical; 0,12 mm; 3,1 cm	29
112 09 0010	Nůž na meniskus fig.1	Meniscus knife fig.1	43
112 09 0020	Nůž na meniskus fig.2	Meniscus knife fig.2	43
112 09 0030	Nůž na meniskus fig.3	Meniscus knife fig.3	43
112 12 0020	Thiersch nůž transplantační; 23,5 cm	Thiersch transplantation knife; 23,5 cm	44
112 12 0120	Humby nůž transplantační; 37,5 cm	Humby transplantation knife; 37,5 cm	45
112 12 0130	Čepel pro nůž transplantační; 158 mm	Blade for transplantation knife; 158 mm	45
112 12 0230	Humby nůž transplantační; 33,4 cm	Humby transplantation knife; 33,4 cm	45
112 12 0240	Čepel pro nůž transplantační; 198 mm	Blade for transplantation knife; 198 mm	45
112 14 0400	Nůž na varixy; 22,0 cm	Knife for varices; 22,0 cm	33
112 14 0420	Nůž na varixy fig.3	Knife for varices fig.3	33
112 14 0430	Nůž na varixy fig.4	Knife for varices fig.4	33
112 14 0440	Nůž na varixy fig.5	Knife for varices fig.5	33
112 14 0450	Nůž na varixy fig.6	Knife for varices fig.6	33
112 14 0510	Nůž na varixy 3,5 mm; 2,1 mm	Knife for varices; 2,1 mm	33
112 14 0520	Nůž na varixy 4,0 mm; 2,8 mm	Knife for varices; 2,8 mm	33
112 14 0550	Nůž na varixy 2,5 mm; 1,5 mm	Knife for varices; 1,5 mm	33
112 14 0560	Nůž na varixy zahnutý; 2,2 mm; 2,0 mm	Knife for varices; 2,2 mm; 2,0 mm	33
112 14 0570	Nůž na varixy; 3,3 mm; 3,0 mm	Knife for varices; 3,3 mm; 3,0 mm	33
112 14 0610	Čtyřhran pro varixy fig.1	Varicose vein knife - four-edges fig.1	35
112 14 0620	Čtyřhran pro varixy fig.2	Varicose vein knife - four-edges fig.2	35

číslo – number	název	item	strana – page
112 14 0630	Čtyřhran pro varixy fig.3	Varicose vein knife - four-edges fig.3	35
112 14 0640	Čtyřhran pro varixy fig.4	Varicose vein knife - four-edges fig.4	35
112 14 0650	Čtyřhran pro varixy fig.5	Varicose vein knife - four-edges fig.5	35
112 14 0660	Čtyřhran pro varixy fig.6	Varicose vein knife - four-edges fig.6	35
112 14 0670	Čtyřhran pro varixy fig.7	Varicose vein knife - four-edges fig.7	35
112 14 0680	Stripper; 3,5 mm; 23,5 cm	Stripper; 3,5 mm; 23,5 cm	33,34
112 14 0690	Stripper; 4,5 mm; 29,0 cm	Stripper; 4,5 mm; 29,0 cm	33,34
112 14 0700	Stripper; 5,0 mm; 29,0 cm	Stripper; 5,0 mm; 29,0 cm	33,34
112 14 0710	Stripper; 6,0 mm; 29,0 cm	Stripper; 6,0 mm; 29,0 cm	33,34
112 14 0720	Elevatorium; 25,0 cm	Elevatorium; 25,0 cm	33,34
112 14 0730	L dlátko; 25,0 cm	L-chisel; 25,0 cm	33,34
112 14 0740	Dlátko rovné; 27,6 cm	Chisel; 27,6 cm	33,34
112 14 0750	Aplikátor tamponády; 27,3 cm	Tamponade applicator; 27,3 cm	33,34
112 14 0760	Fasciotom; 27,6 cm	Fasciotom; 27,6 cm	33,34
112 27 0040	Skalpel s hranatým dl. držadlem; 21,8 cm	Operating knife for gynaecology; 21,8 cm	36
112 27 0050	Skalpel s hranatým dl. držadlem bříškatý; 21,1 cm	Operating knife for gynaecology; 21,1 cm	36
112 27 0060	Skalpel s hranatým dl. držadlem hrotnatý; 21,5 cm	Operating knife for gynaecology; 21,5 cm	36
112 27 0250	Segond nůž na myomy dvojbitý; 22,3 cm	Segond myoma knife; 22,3 cm	36
112 29 0010	Agnew jehla paracentésní-nerez; 15,7 cm	Agnew paracentesis needle; 15,7 cm	37
112 29 0020	Schwartz jehla paracentésní; 15,7 cm	Schwartz paracentesis needle; 15,7 cm	37
112 29 0040	Lucae jehla paracentésní; 17,5 cm	Lucae paracentesis needle; 17,5 cm	37
112 29 0100	Nůž na furunkl s kyretou; 15,0 cm	Furuncle knife with curette; 15,0 cm	37
112 29 0110	Politzer nůž na furunkl; 17,0 cm	Politzer furuncle knife; 17,0 cm	37
112 29 0120	Schwartz tenotom ušní fig.1	Schwartz tenotomy knife fig.1	37
112 29 0130	Schwartz tenotom ušní fig.2	Schwartz tenotomy knife fig.2	37
112 29 0150	Stacke nůž na zvukovod fig.1; 12,6 cm	Stacke sounds knife fig.1; 12,6 cm	38
112 29 0160	Stacke nůž na zvukovod fig.2; 12,6 cm	Stacke sounds knife fig.2; 12,6 cm	38
112 30 0010	Halle nůž na nosní plastiku; 12,0 cm	Halle nasal plastic knife; 12,0 cm	38
112 30 0050	Joseph nůž na nosní plastiku; 14,5 cm	Joseph nasal plastic knife; 14,5 cm	37
112 30 0070	Heymann nůž na nosní plastiku; 15,5 cm	Heymann nasal plastic knife; 15,5 cm	38
112 30 0100	Joseph nůž na nosní plastiku tupý; 14,5 cm	Joseph nasal plastic knife; 14,5 cm	38
112 30 0260	Ballanger nůž na nosní přepážku fig.1	Ballanger knife for septum fig.1	39
112 30 0270	Ballanger nůž na nosní přepážku fig.2	Ballanger knife for septum fig.2	39
112 30 0300	Beckmann kyreta nosohltanová fig.1	Beckmann adenoid curette fig.1	39
112 30 0310	Beckmann kyreta nosohltanová fig.2	Beckmann adenoid curette fig.2	39
112 30 0320	Beckmann kyreta nosohltanová fig.3	Beckmann adenoid curette fig.3	39
112 30 0330	Beckmann kyreta nosohltanová fig.4	Beckmann adenoid curette fig.4	39
112 30 0450	Čepel náhradní k adenotomu fig.1	Adenotom blade fig.1	39
112 30 0460	Čepel náhradní k adenotomu fig.2	Adenotom blade fig.2	39
112 30 0470	Čepel náhradní k adenotomu fig.3	Adenotom blade fig.3	39
112 32 0080	Nůž na flegmonu; 17,7 cm	Phlegmon knife; 17,7 cm	38
112 33 0020	Baginsky nůž hrtanový; 24,5 cm	Baginsky laryngeal knife; 24,5 cm	38
112 38 0010	Dieffenbach skalpel oční bříškatý; 1,7 cm	Dieffenbach operating knife fig.1; 1,7 cm	32
112 38 0020	Dieffenbach skalpel oční bříškatý; 2,0 cm	Dieffenbach operating knife fig.2; 2,0 cm	32
112 38 0030	Dieffenbach skalpel oční bříškatý; 2,5 cm	Dieffenbach operating knife fig.4; 2,5 cm	32
112 38 0040	Dieffenbach skalpel oční bříškatý; 3,0 cm	Dieffenbach operating knife fig.5; 3,0 cm	32
112 38 0110	Dieffenbach skalpel oční hrotnatý; 1,7 cm	Dieffenbach operating knife fig.7; 1,7 cm	32
112 38 0120	Dieffenbach skalpel oční hrotnatý; 2,0 cm	Dieffenbach operating knife fig.8; 2,0 cm	32
112 38 0130	Dieffenbach skalpel oční hrotnatý; 2,5 cm	Dieffenbach operating knife fig.9; 2,5 cm	32
112 38 0140	Dieffenbach skalpel oční hrotnatý; 3,0 cm	Dieffenbach operating knife fig.10; 3,0 cm	32
112 38 2200	Nástroj na cizí tělesa v rohovce dvojité	Double foreign body instrument	32
112 91 0002	Držátko skalpelových čepelk č.3 s měřítkem	Scalpel handle no.3 with ruler	27
112 91 0003	Držátko skalpelových čepelk č.3	Scalpel handle no.3	27
112 91 0004	Držátko skalpelových čepelk č.4	Scalpel handle no.4	27
112 91 0005	Držátko skalpelových čepelk č.3l	Scalpel handle no.3l chr.	27
112 91 0006	Držátko skalpelových čepelk č.4l	Scalpel handle no.4l chr.	27
112 91 0007	Držátko skalpelových čepelk	Scalpel handle	28
112 91 0008	Držátko skalpelových čepelk	Scalpel handle	28
112 91 0009	Skalpel s plochým držadlem bříškatý - nerez; 17,0 cm	Operating knife fig.3; 17,0 cm	30
112 91 0010	Čepelka skalpelová fig.10 (baleno po 100 ks)	Pck=100 blades fig.10	29
112 91 0011	Čepelka skalpelová fig.11 (baleno po 100 ks)	Pck=100 blades fig.11	29
112 91 0012	Čepelka skalpelová fig.12 (baleno po 100 ks)	Pck=100 blades fig.12	29
112 91 0013	Čepelka skalpelová fig.13 (baleno po 100 ks)	Pck=100 blades fig.13	29
112 91 0015	Čepelka skalpelová fig.15 (baleno po 100 ks)	Pck=100 blades fig.15	29
112 91 0018	Čepelka skalpelová fig.18 (baleno po 100 ks)	Pck=100 blades fig.18	29
112 91 0019	Čepelka skalpelová fig.19 (baleno po 100 ks)	Pck=100 blades fig.19	29
112 91 0020	Čepelka skalpelová fig.20 (baleno po 100 ks)	Pck=100 blades fig.20	29
112 91 0021	Čepelka skalpelová fig.21 (baleno po 100 ks)	Pck=100 blades fig.21	29
112 91 0022	Čepelka skalpelová fig.22 (baleno po 100 ks)	Pck=100 blades fig.22	29
112 91 0023	Čepelka skalpelová fig.23 (baleno po 100 ks)	Pck=100 blades fig.23	29
112 91 0024	Čepelka skalpelová fig.24 (baleno po 100 ks)	Pck=100 blades fig.24	29

číslo – number	název	item	strana – page
112 91 0025	Čepelka skalpelová fig.12d (baleno po 100 ks)	Pck=100 blades fig.12d	29
112 91 0026	Čepelka skalpelová fig.15c (baleno po 100 ks)	Pck=100 blades fig.15c	29
112 91 0031	Skalpel s plochým držadlem hrotnatý - nerez; 17,0 cm	Operating knife fig.12; 17,0 cm	30
112 91 0062	Collin amputační nůž; čepel 13,0 cm; 26,0 cm	Collin amputating knife; blade 13,0 cm; 26,0 cm	41
112 91 0067	Catlin amputační nůž; čepel 16,0 cm; 29,0 cm	Catlin amputating knife; blade 16,0 cm; 29,0 cm	41
112 91 0069	Catlin amputační nůž; čepel 22,0 cm; 35,0 cm	Catlin amputating knife; blade 22,0 cm; 35,0 cm	41
112 91 0073	Langenbeck amputační nůž; čepel 12,0 cm; 25,0 cm	Langenbeck amputating knife; blade 12,0 cm; 25,0 cm	41
112 91 0087	Rehn nůž transplantační; 25,0 cm	Rehn transplantation knife; 25,0 cm	44
112 91 0088	Schink nůž transplantační; 30,0 cm	Schink transplantation knife; 30,0 cm	44
112 91 0089	Čepel k transplantačnímu noži Schink	Blade for transplantation knife Schink	44
112 91 0284	La Force adenotom fig. 1; 25,0 cm	La Force adenotom; 25,0 cm	40
112 91 0285	La Force adenotom fig. 2; 25,0 cm	La Force adenotom; 25,0 cm	40
112 91 0286	La Force adenotom fig. 3; 25,0 cm	La Force adenotom; 25,0 cm	40
112 91 0287	Čepel náhradní pro La Force fig.1	Spare blade for La Force	40
112 91 0288	Čepel náhradní pro La Force fig.2	Spare blade for La Force	40
112 91 0289	Čepel náhradní pro La Force fig.3	Spare blade for La Force	40
112 91 0290	La Force adenotom fig. 1; 25,0 cm	La Force adenotom; 25,0 cm	40
112 91 0291	La Force adenotom fig. 2; 25,0 cm	La Force adenotom; 25,0 cm	40
112 91 0292	La Force adenotom fig. 3; 25,0 cm	La Force adenotom; 25,0 cm	40
112 91 0293	Čepel náhradní pro La Force fig.1	Spare blade for La Force	40
112 91 0294	Čepel náhradní pro La Force fig.2	Spare blade for La Force	40
112 91 0295	Čepel náhradní pro La Force fig.3	Spare blade for La Force	40
112 99 0002	Nůž vypichovací na varixy	Poking knife for varices	35
112 99 0011	Nůž klapův; 2,5 mm; 22 cm	Knife klapuv; 2,5 mm; 22 cm	35
112 99 0014	Nůž klapův; 4 mm; 22 cm	Knife klapuv; 4 mm; 22 cm	35
113	NŮŽKY	SCISSORS	
113 01 0210	Nůžky na kosti rovné; 22,0 cm	Bone scissors; 22,0 cm	49
113 01 0230	Nůžky na kosti zahnuté; 22,0 cm	Bone scissors; 22,0 cm	49
113 01 0520	Nůžky na střeva; 22,0 cm	Enterotomy scissors; 22,0 cm	63
113 05 0010	Richter nůžky chirurgické hrotnatotupé lomené; 15,0 cm	Richter operating scissors; 15,0 cm	49
113 05 0020	Richter nůžky chirurgické tupé lomené; 15,0 cm	Richter operating scissors; 15,0 cm	49
113 05 0030	Lister nůžky na obvazy; 15,0 cm	Lister bandage scissors; 15,0 cm	72
113 05 0040	Lister nůžky na obvazy; 20,0 cm	Lister bandage scissors; 20,0 cm	72
113 05 0210	Nůžky na měkké obvazy; 23,5 cm	Plaster scissors; 23,5 cm	71
113 08 0010	Nůžky chirurgické rovné hrotnaté; 13,0 cm	Standard operating scissors; 13,0 cm	50
113 08 0020	Nůžky chirurgické rovné hrotnaté; 15,0 cm	Standard operating scissors; 15,0 cm	50
113 08 0040	Nůžky chirurgické rovné hrotnaté; 18,5 cm	Standard operating scissors; 18,5 cm	50
113 08 0060	Nůžky chirurgické rovné hrotnaté; 22,0 cm	Standard operating scissors; 22,0 cm	50
113 08 0070	Nůžky chirurgické rovné hrotnaté; 30,0 cm	Standard operating scissors; 30,0 cm	50
113 08 0110	Nůžky chirurgické rovné hrotnatotupé; 13,0 cm	Standard operating scissors; 13,0 cm	51
113 08 0120	Nůžky chirurgické rovné hrotnatotupé; 15,0 cm	Standard operating scissors; 15,0 cm	51, 441, 451
113 08 0140	Nůžky chirurgické rovné hrotnatotupé; 18,5 cm	Standard operating scissors; 18,5 cm	51
113 08 0160	Nůžky chirurgické rovné hrotnatotupé; 22,0 cm	Standard operating scissors; 22,0 cm	51
113 08 0170	Nůžky chirurgické rovné hrotnatotupé; 30,0 cm	Standard operating scissors; 30,0 cm	51
113 08 0210	Nůžky chirurgické rovné tupé; 13,0 cm	Standard operating scissors; 13,0 cm	51
113 08 0220	Nůžky chirurgické rovné tupé; 15,0 cm	Standard operating scissors; 15,0 cm	51
113 08 0240	Nůžky chirurgické rovné tupé; 18,5 cm	Standard operating scissors; 18,5 cm	51
113 08 0260	Nůžky chirurgické rovné tupé; 22,0 cm	Standard operating scissors; 22,0 cm	51
113 08 0270	Nůžky chirurgické rovné tupé; 30,0 cm	Standard operating scissors; 30,0 cm	51
113 08 0310	Nůžky chirurgické zahnuté hrotnaté; 13,0 cm	Standard operating scissors; 13,0 cm	50
113 08 0320	Nůžky chirurgické zahnuté hrotnaté; 15,0 cm	Standard operating scissors; 15,0 cm	50
113 08 0340	Nůžky chirurgické zahnuté hrotnaté; 18,5 cm	Standard operating scissors; 18,5 cm	50
113 08 0360	Nůžky chirurgické zahnuté hrotnaté; 22,0 cm	Standard operating scissors; 22,0 cm	50
113 08 0370	Nůžky chirurgické zahnuté hrotnaté; 30,0 cm	Standard operating scissors; 30,0 cm	50
113 08 0410	Nůžky chirurgické zahnuté hrotnatotupé; 13,0 cm	Standard operating scissors; 13,0 cm	51
113 08 0420	Nůžky chirurgické zahnuté hrotnatotupé; 15,0 cm	Standard operating scissors; 15,0 cm	51
113 08 0440	Nůžky chirurgické zahnuté hrotnatotupé; 18,5 cm	Standard operating scissors; 18,5 cm	51
113 08 0460	Nůžky chirurgické zahnuté hrotnatotupé; 22,0 cm	Standard operating scissors; 22,0 cm	51
113 08 0470	Nůžky chirurgické zahnuté hrotnatotupé; 30,0 cm	Standard operating scissors; 30,0 cm	51
113 08 0510	Nůžky chirurgické zahnuté tupé; 13,0 cm	Standard operating scissors; 13,0 cm	51
113 08 0520	Nůžky chirurgické zahnuté tupé; 15,0 cm	Standard operating scissors; 15,0 cm	51
113 08 0540	Nůžky chirurgické zahnuté tupé; 18,5 cm	Standard operating scissors; 18,5 cm	51
113 08 0560	Nůžky chirurgické zahnuté tupé; 22,0 cm	Standard operating scissors; 22,0 cm	51
113 08 0570	Nůžky chirurgické zahnuté tupé; 30,0 cm	Standard operating scissors; 30,0 cm	51
113 08 0700	Metzenbaum nůžky preparační zahnuté; 14,0 cm	Metzenbaum dissecting scissors; 14,0 cm	54
113 08 0810	Nůžky chirurgické na incisi; 15,0 cm	Incision scissors; 15,0 cm	49
113 08 0830	Nůžky preparační rovné extra silné; 17,0 cm	Dissecting scissors; 17,0 cm	55
113 08 0840	Nůžky preparační zahnuté extra silné; 17,0 cm	Dissecting scissors; 17,0 cm	55
113 08 0880	Nůžky preparační rovné jemné; 18,5 cm	Dissecting scissors; 18,5 cm	56
113 08 0890	Nůžky preparační zahnuté jemné; 18,5 cm	Dissecting scissors; 18,5 cm	56
113 08 0930	Nůžky preparační rovné; 17,0 cm	Dissecting scissors; 17,0 cm	56

číslo – number	název	item	strana – page
113 08 0940	Nůžky preparační zahnuté; 17,0 cm	Dissecting scissors; 17,0 cm	56
113 08 1000	Nůžky na stříhání vlasů rovné hrotnaté; 16,5 cm	Hair scissors; 16,5 cm	71
113 10 0110	Nůžky preparační dětské tupé rovné; 18,5 cm	Dissecting scissors; 18,5 cm	57
113 10 0120	Nůžky preparační dětské tupé zahnuté; 18,5 cm	Dissecting scissors; 18,5 cm	57
113 10 0210	Nůžky preparační tupé rovné jemné; 18,5 cm	Dissecting scissors; 18,5 cm	57
113 10 0220	Nůžky preparační tupé zahnuté jemné; 18,5 cm	Dissecting scissors; 18,5 cm	57
113 12 0010	Nůžky preparační s oboustraným ostřím rovné; 12,0 cm	Dissecting scissors; 12,0 cm	58
113 12 0020	Nůžky preparační s oboustraným ostřím zahnuté; 12,0 cm	Dissecting scissors; 12,0 cm	58
113 17 0010	Nůžky neurochirurgické rovné hrotnaté; 19,0 cm	Neurosurgical scissors; 19,0 cm	61
113 17 0020	Nůžky neurochirurgické rovné tupé; 19,0 cm	Neurosurgical scissors; 19,0 cm	61
113 17 0030	Nůžky neurochirurgické zahnuté hrotnaté; 19,0 cm	Neurosurgical scissors; 19,0 cm	61
113 17 0040	Nůžky neurochirurgické lomené hrotnaté; 19,0 cm	Neurosurgical scissors; 19,0 cm	61
113 27 0010	Siebolt nůžky děložní; 24,0 cm	Siebolt uterine scissors; 24,0 cm	53
113 30 0010	Heymann nůžky nosní lomené; 18,0 cm	Heymann nasal scissors; 18,0 cm	64
113 32 0010	Prince nůžky na mandle; 18,5 cm	Prince tonsil scissors; 18,5 cm	64
113 38 0010	Nůžky oční rovné hrotnaté; 10,0 cm	Eye scissors; 10,0 cm	65
113 38 0020	Nůžky oční rovné hrotnatotupé; 10,0 cm	Eye scissors; 10,0 cm	65
113 38 0030	Nůžky oční rovné tupé; 10,0 cm	Eye scissors; 10,0 cm	65
113 38 0040	Nůžky oční zahnuté hrotnaté; 10,0 cm	Eye scissors; 10,0 cm	65
113 38 0050	Nůžky oční zahnuté hrotnatotupé; 10,0 cm	Eye scissors; 10,0 cm	65
113 38 0060	Nůžky oční zahnuté tupé; 10,0 cm	Eye scissors; 10,0 cm	65
113 38 0071	Nůžky oční rovné hrotnaté; 11,5 cm	Eye scissors; 11,5 cm	65
113 38 0081	Nůžky oční rovné tupé; 11,5 cm	Eye scissors; 11,5 cm	65
113 38 0091	Nůžky oční zahnuté hrotnaté; 11,5 cm	Eye scissors; 11,5 cm	65
113 38 0100	Nůžky oční zahnuté hrotnatotupé; 11,5 cm	Eye scissors; 11,5 cm	65
113 38 0150	Nůžky oční rovné hrotnatotupé; 11,5 cm	Eye scissors; 11,5 cm	65
113 38 0161	Nůžky oční zahnuté tupé; 11,5 cm	Eye scissors; 11,5 cm	65
113 38 0210	Nůžky oční lomené hrotnaté; 10,5 cm	Eye scissors; 10,5 cm	65
113 38 0260	Nůžky oční lomené tupé; 10,5 cm	Eye scissors; 10,5 cm	65
113 38 0311	Nůžky oční stranou zahnuté hrotnaté; 11,5 cm	Eye scissors; 11,5 cm	65
113 38 0550	Nůžky enukleační zahnuté; 13,0 cm	Enucleation scissors; 13,0 cm	66
113 38 0850	Nůžky oční pružinové rovné rohokové; 13,0 cm	Eye scissors for cornea; 13,0 cm	67
113 38 0860	Nůžky oční pružinové zahnuté rohokové; 13,0 cm	Eye scissors for cornea; 13,0 cm	67
113 38 1020	Castroviejo nůžky oční zahnuté; 9,0 cm	Castroviejo eye scissors; 9,0 cm	67
113 38 1030	Castroviejo nůžky oční lomené; 9,0 cm	Castroviejo eye scissors; 9,0 cm	67
113 50 0010	Nůžky na dásně rovné hrotnaté; 12,0 cm	Gum scissors; 12,0 cm	73
113 50 0020	Nůžky na dásně zahnuté hrotnaté; 12,0 cm	Gum scissors; 12,0 cm	73
113 50 0030	Nůžky na dásně rovné hrotnaté; 14,5 cm	Gum scissors; 14,5 cm	73
113 50 0040	Nůžky na dásně zahnuté hrotnaté; 14,5 cm	Gum scissors; 14,5 cm	73
113 91 0002	Nůžky chirurgické tupé rovné; 11,5 cm	Standard operating scissors; 11,5 cm	51
113 91 0006	Nůžky chirurgické tupé rovné; 16,5 cm	Standard operating scissors; 16,5 cm	51
113 91 0009	Nůžky chirurgické tupé rovné; 20,0 cm	Standard operating scissors; 20,0 cm	51
113 91 0011	Nůžky chirurgické tupé zahnuté; 11,5 cm	Standard operating scissors; 11,5 cm	51
113 91 0015	Nůžky chirurgické tupé zahnuté; 16,5 cm	Standard operating scissors; 16,5 cm	51
113 91 0018	Nůžky chirurgické tupé zahnuté; 20,0 cm	Standard operating scissors; 20,0 cm	51
113 91 0020	Nůžky chirurgické hrotnatotupé rovné; 11,5 cm	Standard operating scissors; 11,5 cm	51
113 91 0026	Nůžky chirurgické hrotnatotupé rovné; 16,5 cm	Standard operating scissors; 16,5 cm	51
113 91 0029	Nůžky chirurgické hrotnatotupé rovné; 20,0 cm	Standard operating scissors; 20,0 cm	51
113 91 0031	Nůžky chirurgické hrotnatotupé zahnuté; 11,5 cm	Standard operating scissors; 11,5 cm	51
113 91 0037	Nůžky chirurgické hrotnatotupé zahnuté; 16,5 cm	Standard operating scissors; 16,5 cm	51
113 91 0040	Nůžky chirurgické hrotnatotupé zahnuté; 20,0 cm	Standard operating scissors; 20,0 cm	51
113 91 0042	Nůžky chirurgické hrotnaté rovné; 11,5 cm	Standard operating scissors; 11,5 cm	50
113 91 0046	Nůžky chirurgické hrotnaté rovné; 16,5 cm	Standard operating scissors; 16,5 cm	50
113 91 0049	Nůžky chirurgické hrotnaté rovné; 20,0 cm	Standard operating scissors; 20,0 cm	50
113 91 0051	Nůžky chirurgické hrotnaté zahnuté; 11,5 cm	Standard operating scissors; 11,5 cm	50
113 91 0055	Nůžky chirurgické hrotnaté zahnuté; 16,5 cm	Standard operating scissors; 16,5 cm	50
113 91 0058	Nůžky chirurgické hrotnaté zahnuté; 20,0 cm	Standard operating scissors; 20,0 cm	50
113 91 0071	Nůžky na incisi; 13,0 cm	Incision scissors; 13,0 cm	49
113 91 0072	Nůžky na incisi; 14,5 cm	Incision scissors; 14,5 cm	49
113 91 0075	Fergusson nůžky chirurgické; 16,5 cm	Fergusson operating scissors; 16,5 cm	50
113 91 0076	Fergusson nůžky chirurgické; 18,0 cm	Fergusson operating scissors; 18,0 cm	50
113 91 0077	Deaver nůžky chirurgické hrotnatotupé rovné; 14,0 cm	Deaver operating scissors; 14,0 cm	50
113 91 0078	Deaver nůžky chirurgické hrotnatotupé zahnuté; 14,0 cm	Deaver operating scissors; 14,0 cm	50
113 91 0083	Mayo nůžky preparační tupé rovné; 14,5 cm	Mayo dissecting scissors; 14,5 cm	55
113 91 0087	Mayo nůžky preparační tupé rovné; 23,0 cm	Mayo dissecting scissors; 23,0 cm	55
113 91 0090	Mayo nůžky preparační tupé zahnuté; 14,5 cm	Mayo dissecting scissors; 14,5 cm	55
113 91 0094	Mayo nůžky preparační tupé zahnuté; 23,0 cm	Mayo dissecting scissors; 23,0 cm	55
113 91 0097	Mayo-Stille nůžky preparační tupé rovné; 15,0 cm	Mayo-Stille dissecting scissors; 15,0 cm	55
113 91 0098	Mayo-Stille nůžky preparační tupé rovné; 17,0 cm	Mayo-Stille dissecting scissors; 17,0 cm	55
113 91 0101	Mayo-Stille nůžky preparační tupé zahnuté; 15,0 cm	Mayo-Stille dissecting scissors; 15,0 cm	55
113 91 0102	Mayo-Stille nůžky preparační tupé zahnuté; 17,0 cm	Mayo-Stille dissecting scissors; 17,0 cm	55

číslo – number	název	item	strana – page
113 91 0106	Doyen nůžky břišní tupé rovné; 16,0 cm	Doyen abdominal scissors; 16,0 cm	52
113 91 0107	Doyen nůžky břišní tupé zahnuté; 16,0 cm	Doyen abdominal scissors; 16,0 cm	52
113 91 0110	Kelly nůžky na fistuli rovné; 16,0 cm	Kelly fistula scissors; 16,0 cm	52
113 91 0112	Kelly nůžky na fistuli zahnuté; 16,0 cm	Kelly fistula scissors; 16,0 cm	52
113 91 0116	Wertheim nůžky břišní tupé zahnuté; 22,5 cm	Wertheim operating scissors; 22,5 cm	52
113 91 0117	Sims nůžky gynekologické tupé rovné; 20,0 cm	Sims gynaecological scissors; 20,0 cm	53
113 91 0118	Sims nůžky gynekologické tupé rovné; 23,0 cm	Sims gynaecological scissors; 23,0 cm	53
113 91 0119	Sims nůžky gynekologické tupé zahnuté; 20,0 cm	Sims gynaecological scissors; 20,0 cm	53
113 91 0120	Sims nůžky gynekologické tupé zahnuté; 23,0 cm	Sims gynaecological scissors; 23,0 cm	53
113 91 0121	Sims nůžky gynekologické hrotnatotupé rovné; 20,0 cm	Sims gynaecological scissors; 20,0 cm	53
113 91 0122	Sims nůžky gynekologické tupé rovné; 23,0 cm	Sims gynaecological scissors; 23,0 cm	53
113 91 0123	Sims nůžky gynekologické hrotnatotupé zahnuté; 20,0 cm	Sims gynaecological scissors; 20,0 cm	53
113 91 0124	Sims nůžky gynekologické hrotnatotupé zahnuté; 23,0 cm	Sims gynaecological scissors; 23,0 cm	53
113 91 0125	Sims nůžky gynekologické hrotnaté rovné; 20,0 cm	Sims gynaecological scissors; 20,0 cm	53
113 91 0126	Sims nůžky gynekologické hrotnatotupé rovné; 23,0 cm	Sims gynaecological scissors; 23,0 cm	53
113 91 0127	Sims nůžky gynekologické hrotnaté zahnuté; 20,0 cm	Sims gynaecological scissors; 20,0 cm	53
113 91 0128	Sims nůžky gynekologické hrotnaté zahnuté; 23,0 cm	Sims gynaecological scissors; 23,0 cm	53
113 91 0129	Dubois nůžky gynekologické tupé rovné; 27,0 cm	Dubois cephalotomy scissors; 27,0 cm	53
113 91 0130	Dubois nůžky gynekologické tupé zahnuté; 27,0 cm	Dubois cephalotomy scissors; 27,0 cm	53
113 91 0143	Metzenbaum-Nelson nůžky preparační tupé rovné; 18,0 cm	Metzenbaum-Nelson dissecting scissors; 18,0 cm	54
113 91 0145	Metzenbaum-Nelson nůžky preparační tupé rovné; 20,0 cm	Metzenbaum-Nelson dissecting scissors; 20,0 cm	54
113 91 0147	Metzenbaum-Nelson nůžky preparační tupé rovné; 23,0 cm	Metzenbaum-Nelson dissecting scissors; 23,0 cm	54
113 91 0149	Metzenbaum-Nelson nůžky preparační tupé rovné; 25,0 cm	Metzenbaum-Nelson dissecting scissors; 25,0 cm	54
113 91 0150	Metzenbaum-Nelson nůžky preparační tupé rovné; 28,0 cm	Metzenbaum-Nelson dissecting scissors; 28,0 cm	54
113 91 0152	Metzenbaum-Nelson nůžky preparační rovné jemné; 18,0 cm	Metzenbaum-Nelson dissecting scissors; 18,0 cm	54
113 91 0154	Metzenbaum-Nelson nůžky preparační tupé zahnuté; 20,0 cm	Metzenbaum-Nelson dissecting scissors; 20,0 cm	54
113 91 0156	Metzenbaum-Nelson nůžky preparační tupé zahnuté; 23,0 cm	Metzenbaum-Nelson dissecting scissors; 23,0 cm	54
113 91 0158	Metzenbaum-Nelson nůžky preparační tupé zahnuté; 25,0 cm	Metzenbaum-Nelson dissecting scissors; 25,0 cm	54
113 91 0159	Metzenbaum-Nelson nůžky preparační tupé zahnuté; 28,0 cm	Metzenbaum-Nelson dissecting scissors; 28,0 cm	54
113 91 0189	Metzenbaum-Delicate nůžky preparační tupé rovné; 18,0 cm	Metzenbaum-Delicate scissors; 18,0 cm	54
113 91 0190	Metzenbaum-Delicate nůžky preparační tupé rovné; 20,0 cm	Metzenbaum-Delicate scissors; 20,0 cm	54
113 91 0191	Metzenbaum-Delicate nůžky preparační tupé rovné; 23,0 cm	Metzenbaum-Delicate scissors; 23,0 cm	54
113 91 0192	Metzenbaum-Delicate nůžky preparační tupé rovné; 25,0 cm	Metzenbaum-Delicate scissors; 25,0 cm	54
113 91 0195	Metzenbaum-Delicate nůžky preparační tupé zahnuté; 18,0 cm	Metzenbaum-Delicate scissors; 18,0 cm	54
113 91 0196	Metzenbaum-Delicate nůžky preparační tupé zahnuté; 20,0 cm	Metzenbaum-Delicate scissors; 20,0 cm	54
113 91 0197	Metzenbaum-Delicate nůžky preparační tupé zahnuté; 23,0 cm	Metzenbaum-Delicate scissors; 23,0 cm	54
113 91 0198	Metzenbaum-Delicate nůžky preparační tupé zahnuté; 25,0 cm	Metzenbaum-Delicate scissors; 25,0 cm	54
113 91 0215	Lexer nůžky preparační rovné; 16,0 cm	Lexer dissecting scissors; 16,0 cm	57
113 91 0216	Lexer nůžky preparační zahnuté; 16,0 cm	Lexer dissecting scissors; 16,0 cm	57
113 91 0217	Fomon nůžky preparační zahnuté; 13,5 cm	Fomon dissecting scissors; 13,5 cm	56
113 91 0218	Thorek nůžky preparační zahnuté; 19,0 cm	Thorek dissecting scissors; 19,0 cm	56
113 91 0219	Lexer-Baby nůžky preparační rovné; 10,0 cm	Lexer-Baby dissecting scissors; 10,0 cm	56
113 91 0220	Lexer-Baby nůžky preparační zahnuté; 10,0 cm	Lexer-Baby dissecting scissors; 10,0 cm	56
113 91 0221	Sanvenero nůžky preparační hrotnaté rovné; 14,0 cm	Sanvenero dissecting scissors; 14,0 cm	58
113 91 0222	Sanvenero nůžky preparační hrotnaté zahnuté; 14,0 cm	Sanvenero dissecting scissors; 14,0 cm	58
113 91 0229	Kilner nůžky preparační zahnuté; 12,0 cm	Kilner dissecting scissors; 12,0 cm	57
113 91 0230	Kilner nůžky preparační zahnuté; 15,0 cm	Kilner dissecting scissors; 15,0 cm	57
113 91 0233	Reynolds nůžky preparační ostré rovné; 15,0 cm	Reynolds dissecting scissors; 15,0 cm	58
113 91 0235	Reynolds nůžky preparační ostré zahnuté; 15,0 cm	Reynolds dissecting scissors; 15,0 cm	58
113 91 0237	Potts-Smith nůžky zahnuté; 25°; 19,0 cm	Potts-Smith vascular forceps; 25°; 19,0 cm	59
113 91 0238	Potts-Smith nůžky zahnuté; 45°; 19,0 cm	Potts-Smith vascular forceps; 45°; 19,0 cm	59
113 91 0239	Potts-Smith nůžky zahnuté; 60°; 19,0 cm	Potts-Smith vascular forceps; 60°; 19,0 cm	59
113 91 0240	De Bakey nůžky zahnuté; 25°; 16,0 cm	De Bakey vascular scissors; 25°; 16,0 cm	59
113 91 0242	De Bakey nůžky zahnuté; 25°; 23,0 cm	De Bakey vascular scissors; 25°; 23,0 cm	59
113 91 0244	De Bakey nůžky zahnuté; 45°; 16,0 cm	De Bakey vascular scissors; 45°; 16,0 cm	59
113 91 0246	De Bakey nůžky zahnuté; 45°; 23,0 cm	De Bakey vascular scissors; 45°; 23,0 cm	59
113 91 0248	De Bakey nůžky zahnuté; 60°; 16,0 cm	De Bakey vascular scissors; 60°; 16,0 cm	59
113 91 0250	De Bakey nůžky zahnuté; 60°; 23,0 cm	De Bakey vascular scissors; 60°; 23,0 cm	59
113 91 0252	Hegemann-Diethrich nůžky zahnuté; 25°; 16,0 cm	Hegemann-Diethrich vascular scissors; 25°; 16,0 cm	60
113 91 0253	Hegemann-Diethrich nůžky zahnuté; 45°; 16,0 cm	Hegemann-Diethrich vascular scissors; 45°; 16,0 cm	60
113 91 0254	Hegemann-Diethrich nůžky zahnuté; 60°; 16,0 cm	Hegemann-Diethrich vascular scissors; 60°; 16,0 cm	60
113 91 0255	Hegemann-Diethrich nůžky zahnuté; 90°; 16,0 cm	Hegemann-Diethrich vascular scissors; 90°; 16,0 cm	60
113 91 0256	Hegemann-Diethrich nůžky zahnuté; 125°; 16,0 cm	Hegemann-Diethrich vascular scissors; 125°; 16,0 cm	60
113 91 0257	Hegemann-Diethrich nůžky zahnuté; 25°; 19,0 cm	Hegemann-Diethrich vascular scissors; 25°; 19,0 cm	60
113 91 0258	Hegemann-Diethrich nůžky zahnuté; 45°; 19,0 cm	Hegemann-Diethrich vascular scissors; 45°; 19,0 cm	60
113 91 0259	Hegemann-Diethrich nůžky zahnuté; 60°; 19,0 cm	Hegemann-Diethrich vascular scissors; 60°; 19,0 cm	60
113 91 0260	Hegemann-Diethrich nůžky zahnuté; 90°; 19,0 cm	Hegemann-Diethrich vascular scissors; 90°; 19,0 cm	60
113 91 0261	Hegemann-Diethrich nůžky zahnuté; 125°; 19,0 cm	Hegemann-Diethrich vascular scissors; 125°; 19,0 cm	60
113 91 0267	Strully nůžky neurochirurgické zahnuté; 22,0 cm	Strully neurosurgical scissors; 22,0 cm	61
113 91 0270	Favaloro nůžky na cévy; 15,0 cm	Favaloro artery scissors; 15,0 cm	61
113 91 0272	De Bakey nůžky na cévy; 15,5 cm	De Bakey artery scissors; 15,5 cm	62

číslo – number	název	item	strana – page
113 91 0273	Potts-De Dartel nůžky na cévy lomené; 21,0 cm	Potts-De martel artery scissors; 21,0 cm	62
113 91 0275	Schmieden-Taylor nůžky neurochirurgické; 14,5 cm	Schmieden-Taylor dura scissors; 14,5 cm	62
113 91 0276	Schmieden-Taylor nůžky neurochirurgické; 17,0 cm	Schmieden-Taylor dura scissors; 17,0 cm	62
113 91 0278	Toennis nůžky neurochirurgické rovné; 18,0 cm	Toennis dissecting scissors; 18,0 cm	61
113 91 0279	Toennis nůžky neurochirurgické tupé zahnuté; 18,0 cm	Toennis dissecting scissors; 18,0 cm	61
113 91 0280	Klinkenbergh-Loth nůžky neurochirurgické; 23,0 cm	Klinkenbergh-Loth artery scissors; 23,0 cm	62
113 91 0281	Satinsky nůžky neurochirurgické s-zahnuté; 24,5 cm	Satinsky neurosurgical scissors; 24,5 cm	62
113 91 0290	McIndoe nůžky na chrupavku; 19,0 cm	McIndoe cartilage scissors; 19,0 cm	63
113 91 0292	Crafoord nůžky pro lobektomii tupé zahnuté; 30,0 cm	Crafoord lobectomy scissors; 30,0 cm	63
113 91 0295	Nůžky na střeva; 21,0 cm	Enterotomy scissors; 21,0 cm	63
113 91 0296	Nůžky na střeva s olivkou; 22,0 cm	Enterotomy scissors; 22,0 cm	63
113 91 0297	Nůžky anatomické hrotnaté rovné; 11,0 cm	Dissecting scissors; 11,0 cm	63
113 91 0300	Nůžky anatomické hrotnaté zahnuté; 11,0 cm	Dissecting scissors; 11,0 cm	63
113 91 0303	Prince nůžky na mandle zahnuté; 17,5 cm	Prince tonsil scissors; 17,5 cm	64
113 91 0305	Good nůžky na mandle zahnuté; 19,0 cm	Good tonsil scissors; 19,0 cm	64
113 91 0311	Fomon nůžky nosní tupé; 13,5 cm	Fomon nasal scissors; 13,5 cm	64
113 91 0312	Halle nůžky nosní zahnuté; 19,0 cm	Halle nasal scissors; 19,0 cm	64
113 91 0313	Cottle nůžky nosní tupé; 16,0 cm	Cottle nasal scissors; 16,0 cm	64
113 91 0317	Braun-Stadler nůžky pro episiotomii; 14,0 cm	Braun-Stadler episiotomy scissors; 14,0 cm	52
113 91 0318	Braun-Stadler nůžky pro episiotomii; 22,0 cm	Braun-Stadler episiotomy scissors; 22,0 cm	52
113 91 0319	Waldmann nůžky pro episiotomii; 18,0 cm	Waldmann episiotomy scissors; 18,0 cm	52
113 91 0328	Wagner nůžky jemné hrotnaté rovné; 12,0 cm	Wagner fine scissors; 12,0 cm	64
113 91 0331	Wagner nůžky jemné hrotnaté zahnuté; 12,0 cm	Wagner fine scissors; 12,0 cm	64
113 91 0379	Stevens nůžky oční hrotnaté rovné; 10,5 cm	Stevens tenotomy scissors; 10,5 cm	66
113 91 0380	Stevens nůžky oční hrotnaté rovné; 11,5 cm	Stevens tenotomy scissors; 11,5 cm	66
113 91 0381	Stevens nůžky oční hrotnaté zahnuté; 10,5 cm	Stevens tenotomy scissors; 10,5 cm	66
113 91 0382	Stevens nůžky oční hrotnaté zahnuté; 11,5 cm	Stevens tenotomy scissors; 11,5 cm	66
113 91 0383	Stevens nůžky oční tupé rovné; 10,5 cm	Stevens tenotomy scissors; 10,5 cm	66
113 91 0384	Stevens nůžky oční tupé rovné; 11,5 cm	Stevens tenotomy scissors; 11,5 cm	66
113 91 0385	Stevens nůžky oční tupé zahnuté; 10,5 cm	Stevens tenotomy scissors; 10,5 cm	66
113 91 0386	Stevens nůžky oční tupé zahnuté; 11,5 cm	Stevens tenotomy scissors; 11,5 cm	66
113 91 0387	Nůžky oční hrotnaté rovné; 10,0 cm	Eye scissors; 10,0 cm	66
113 91 0388	Nůžky oční hrotnaté zahnuté; 10,0 cm	Eye scissors; 10,0 cm	66
113 91 0389	Nůžky oční tupé rovné; 10,0 cm	Eye scissors; 10,0 cm	66
113 91 0390	Nůžky oční tupé zahnuté; 10,0 cm	Eye scissors; 10,0 cm	66
113 91 0393	Nůžky oční rovné; 9,5 cm	Eye scissors; 9,5 cm	66
113 91 0394	Nůžky oční rovné; 9,5 cm	Eye scissors; 9,5 cm	66
113 91 0395	Nůžky oční rovné; 9,5 cm	Eye scissors; 9,5 cm	66
113 91 0396	Nůžky oční zahnuté; 9,5 cm	Eye scissors; 9,5 cm	66
113 91 0399	Spencer nůžky pro ligaturu; 9,0 cm	Spencer ligature scissors; 9,0 cm	69
113 91 0400	Spencer nůžky pro ligaturu; 10,5 cm	Spencer ligature scissors; 10,5 cm	69
113 91 0403	Littauer nůžky pro ligaturu; 14,0 cm	Littauer ligature scissors; 14,0 cm	69
113 91 0408	Heath nůžky pro ligaturu; 15,0 cm	Heath ligature scissors; 15,0 cm	69
113 91 0411	Northbent nůžky pro ligaturu zahnuté; 12,5 cm	Northbent ligature scissors; 12,5 cm	69
113 91 0432	Universal nůžky na obvazy; 18,0 cm	Universal bandage scissors; 18,0 cm	71
113 91 0437	Smith (mod. USA) nůžky na obvazy; 20,0 cm	Smith (mod. USA) bandage scissors; 20,0 cm	71
113 91 0439	Lorenz nůžky na obvazy zahnuté; 23,0 cm	Lorenz bandage scissors; 23,0 cm	71
113 91 0444	Lister-Excentric nůžky na obvazy se zuby; 16,0 cm	Lister-Excentric scissors; 16,0 cm	72
113 91 0445	Lister-Excentric nůžky na obvazy se zuby; 19,0 cm	Lister-Excentric scissors; 19,0 cm	72
113 91 0446	Lister nůžky na obvazy lomené; 9,0 cm	Lister bandage scissors; 9,0 cm	72
113 91 0447	Lister nůžky na obvazy lomené; 11,0 cm	Lister bandage scissors; 11,0 cm	72
113 91 0448	Lister nůžky na obvazy lomené; 14,0 cm	Lister bandage scissors; 14,0 cm	72
113 91 0450	Lister nůžky na obvazy lomené; 18,0 cm	Lister bandage scissors; 18,0 cm	72
113 91 0452	Esmarch nůžky na obvazy; 20,0 cm	Esmarch bandage scissors; 20,0 cm	72
113 91 0453	Esmarch nůžky na obvazy; 22,0 cm	Esmarch bandage scissors; 22,0 cm	72
113 91 0454	Seutin nůžky na sádrové obvazy; 23,0 cm	Seutin plaster-of-paris shears; 23,0 cm	72
113 91 0455	Nůžky na sádrové obvazy; 20,0 cm	Plaster-of-paris shears; 20,0 cm	72
113 91 0456	Bruns nůžky na sádrové obvazy se zuby; 24,0 cm	Bruns plaster-of-paris shears; 24,0 cm	72
113 91 0457	Bruns nůžky na sádrové obvazy hladké; 24,0 cm	Bruns plaster-of-paris shears; 24,0 cm	72
113 91 0458	Nůžky na nehty rovné; 9,0 cm	Nail scissors; 9,0 cm	74
113 91 0459	Nůžky na nehty rovné; 10,5 cm	Nail scissors; 10,5 cm	74
113 91 0460	Nůžky na nehty zahnuté; 9,0 cm	Nail scissors; 9,0 cm	74
113 91 0461	Nůžky na nehty zahnuté; 10,5 cm	Nail scissors; 10,5 cm	74
113 91 0462	Nůžky na nehty rovné se zahnutými rameny; 9,0 cm	Nail scissors; 9,0 cm	74
113 91 0463	Nůžky na nehty rovné se zahnutými rameny; 10,5 cm	Nail scissors; 10,5 cm	74
113 91 0464	Nůžky na nehty zahnuté se zahnutými rameny; 9,0 cm	Nail scissors; 9,0 cm	74
113 91 0465	Nůžky na nehty zahnuté se zahnutými rameny; 10,5 cm	Nail scissors; 10,5 cm	74
113 91 0466	Nůžky na nehtovou kůžičku rovné; 10,0 cm	Cuticle scissors; 10,0 cm	74
113 91 0467	Nůžky na nehtovou kůžičku rovné; 11,0 cm	Cuticle scissors; 11,0 cm	74
113 91 0468	Nůžky na nehtovou kůžičku zahnuté; 10,0 cm	Cuticle scissors; 10,0 cm	74
113 91 0469	Nůžky na nehtovou kůžičku zahnuté; 11,0 cm	Cuticle scissors; 11,0 cm	74

číslo – number	název	item	strana – page
113 91 0470	Nůžky na nehty s perem chrom; 10,5 cm	Nail scissors; 10,5 cm	74
113 91 0472	König nůžky na nehty; 13,0 cm	König nail splitting scissors; 13,0 cm	74
113 91 0473	König nůžky na nehty; 15,0 cm	König nail splitting scissors; 15,0 cm	74
113 91 0474	Goldman-Fox nůžky na dáseň rovné; 13,0 cm	Goldman-Fox scissors; 13,0 cm	73
113 91 0475	Goldman-Fox nůžky na dáseň zahnuté; 13,0 cm	Goldman-Fox scissors; 13,0 cm	73
113 91 0483	Quinby nůžky na dáseň rovné; 12,0 cm	Quinby gum scissors; 12,0 cm	73
113 91 0484	Quinby nůžky na dáseň zahnuté; 12,0 cm	Quinby gum scissors; 12,0 cm	73
113 91 0490	Noyes nůžky na duhovku hrotnaté rovné; 12,0 cm	Noyes iris scissors; 12,0 cm	67
113 91 0492	Noyes nůžky na duhovku hrotnatotupé rovné; 12,0 cm	Noyes iris scissors; 12,0 cm	67
113 91 0494	Noyes nůžky na duhovku tupé rovné; 12,0 cm	Noyes iris scissors; 12,0 cm	67
113 91 0499	Barraquer nůžky na duhovku; 5,5 cm; 5 mm	Barraquer eye scissors; 5,5 cm; 5 mm	67
113 91 0500	Barraquer nůžky na duhovku; 5,5 cm; 7 mm	Barraquer eye scissors; 5,5 cm; 7 mm	67
113 91 0501	Barraquer nůžky na duhovku; 5,5 cm; 10 mm	Barraquer eye scissors; 5,5 cm; 10 mm	67
113 91 0502	Castroviejo nůžky na duhovku ostré rovné; 9,0 cm	Castroviejo iris scissors; 9,0 cm	67
113 91 0503	Castroviejo nůžky na duhovku tupé rovné; 9,0 cm	Castroviejo iris scissors; 9,0 cm	67
113 91 0505	Castroviejo nůžky na duhovku tupé lomené; 9,0 cm	Castroviejo iris scissors; 9,0 cm	67
113 91 0507	Castroviejo nůžky na duhovku hrotnaté; 10,0 cm	Castroviejo iris scissors; 10,0 cm	67
113 91 0508	Castroviejo nůžky na duhovku tupé; 10,0 cm	Castroviejo iris scissors; 10,0 cm	67
113 91 0517	Westcott nůžky na rohovku hrotnaté; 11,0 cm	Westcott tenotomy scissors; 11,0 cm	68
113 91 0518	Westcott nůžky na rohovku tupé; 11,0 cm	Westcott tenotomy scissors; 11,0 cm	68
113 91 0521	Castroviejo nůžky oční jemné levé; 11,0 cm	Castroviejo delicate eye scissors; 11,0 cm	68
113 91 0522	Castroviejo nůžky oční jemné pravé; 11,0 cm	Castroviejo delicate eye scissors; 11,0 cm	68
113 91 0537	Gomel nůžky mikro tupé; 14,5 cm	Gomel dissection micro scissors; 14,5 cm	70
113 91 0538	Gomel nůžky mikro tupé; 18,0 cm	Gomel dissection micro scissors; 18,0 cm	70
113 91 0539	Gomel nůžky mikro hrotnaté; 14,5 cm	Gomel dissection micro scissors; 14,5 cm	70
113 91 0540	Gomel nůžky mikro hrotnaté; 18,0 cm	Gomel dissection micro scissors; 18,0 cm	70
113 91 0552	Nůžky mikro; rovné 18,5 cm	Dissection micro scissors; straight 18,5 cm	70
113 91 0553	Nůžky mikro; zahnuté 18,5 cm	Dissection micro scissors; curved 18,5 cm	70
113 91 0573	Nůžky mikro; 25°; 18,0 cm	Micro scissors; 25°; 18,0 cm	69
113 91 0574	Nůžky mikro; 45°; 18,0 cm	Micro scissors; 45°; 18,0 cm	69
113 91 0575	Nůžky mikro; 60°; 18,0 cm	Micro scissors; 60°; 18,0 cm	69
113 91 0576	Nůžky mikro; 90°; 18,0 cm	Micro scissors; 90°; 18,0 cm	69
113 91 0577	Nůžky mikro; 125°; 18,0 cm	Micro scissors; 125°; 18,0 cm	69
113 91 0578	Nůžky mikro; 25°; 18,0 cm	Micro scissors; 25°; 18,0 cm	69
113 91 0579	Nůžky mikro; 45°; 18,0 cm	Micro scissors; 45°; 18,0 cm	69
113 91 0580	Nůžky mikro; 60°; 18,0 cm	Micro scissors; 60°; 18,0 cm	69
113 91 0581	Nůžky mikro; 90°; 18,0 cm	Micro scissors; 90°; 18,0 cm	69
113 91 0582	Nůžky mikro; 125°; 18,0 cm	Micro scissors; 125°; 18,0 cm	69
113 91 0601	Mayo nůžky tupé rovné tvrdokovové; 14,5 cm	Mayo dissecting scissors TUC; 14,5 cm	79
113 91 0602	Mayo nůžky tupé rovné tvrdokovové; 17,0 cm	Mayo dissecting scissors TUC; 17,0 cm	79
113 91 0603	Mayo nůžky tupé rovné tvrdokovové; 23,0 cm	Mayo dissecting scissors TUC; 23,0 cm	79
113 91 0604	Mayo nůžky tupé zahnuté tvrdokovové; 14,5 cm	Mayo dissecting scissors TUC; 14,5 cm	79
113 91 0605	Mayo nůžky tupé zahnuté tvrdokovové; 17,0 cm	Mayo dissecting scissors TUC; 17,0 cm	79
113 91 0606	Mayo nůžky tupé zahnuté tvrdokovové; 23,0 cm	Mayo dissecting scissors TUC; 23,0 cm	79
113 91 0607	Parametrium nůžky zahnuté tvrdokovové; 22,5 cm	Parametrium scissors TUC; 22,5 cm	79
113 91 0608	Parametrium nůžky zahnuté tvrdokovové; 23,0 cm	Parametrium scissors TUC; 23,0 cm	79
113 91 0609	Mayo-Stille nůžky tupé rovné tvrdokovové; 15,0 cm	Mayo-Stille scissors TUC; 15,0 cm	80
113 91 0610	Mayo-Stille nůžky tupé rovné tvrdokovové; 17,0 cm	Mayo-Stille scissors TUC; 17,0 cm	80
113 91 0611	Mayo-Stille nůžky tupé zahnuté tvrdokovové; 15,0 cm	Mayo-Stille scissors TUC; 15,0 cm	80
113 91 0612	Mayo-Stille nůžky tupé zahnuté tvrdokovové; 17,0 cm	Mayo-Stille scissors TUC; 17,0 cm	80
113 91 0617	Metzenbaum nůžky tupé rovné tvrdokovové; 11,5 cm	Metzenbaum scissors TUC; 11,5 cm	80
113 91 0618	Metzenbaum nůžky tupé zahnuté tvrdokovové; 11,5 cm	Metzenbaum scissors TUC; 11,5 cm	80
113 91 0621	Metzenbaum nůžky tupé rovné tvrdokovové; 18,0 cm	Metzenbaum scissors TUC; 18,0 cm	81
113 91 0622	Metzenbaum nůžky tupé rovné tvrdokovové; 20,0 cm	Metzenbaum scissors TUC; 20,0 cm	81
113 91 0623	Metzenbaum nůžky tupé rovné tvrdokovové; 23,0 cm	Metzenbaum scissors TUC; 23,0 cm	81
113 91 0624	Metzenbaum nůžky tupé rovné tvrdokovové; 25,0 cm	Metzenbaum scissors TUC; 25,0 cm	81
113 91 0625	Metzenbaum nůžky tupé rovné tvrdokovové; 28,0 cm	Metzenbaum scissors TUC; 28,0 cm	81
113 91 0627	Metzenbaum nůžky tupé zahnuté tvrdokovové; 18,0 cm	Metzenbaum scissors TUC; 18,0 cm	81
113 91 0628	Metzenbaum nůžky tupé zahnuté tvrdokovové; 20,0 cm	Metzenbaum scissors TUC; 20,0 cm	81
113 91 0629	Metzenbaum nůžky tupé zahnuté tvrdokovové; 23,0 cm	Metzenbaum scissors TUC; 23,0 cm	81
113 91 0630	Metzenbaum nůžky tupé zahnuté tvrdokovové; 25,0 cm	Metzenbaum scissors TUC; 25,0 cm	81
113 91 0631	Metzenbaum nůžky tupé zahnuté tvrdokovové; 28,0 cm	Metzenbaum scissors TUC; 28,0 cm	81
113 91 0633	Potts-Smith nůžky tvrdokovové; 25°; 19,0 cm	Potts-Smith scissors TUC; 25°; 19,0 cm	82
113 91 0634	Potts-Smith nůžky tvrdokovové; 45°; 19,0 cm	Potts-Smith scissors TUC; 45°; 19,0 cm	82
113 91 0635	Potts-Smith nůžky tvrdokovové; 60°; 19,0 cm	Potts-Smith scissors TUC; 60°; 19,0 cm	82
113 91 0636	De Bakey nůžky tvrdokovové; 25°; 18,0 cm	De Bakey scissors TUC; 25°; 18,0 cm	82
113 91 0637	De Bakey nůžky tvrdokovové; 45°; 18,0 cm	De Bakey scissors TUC; 45°; 18,0 cm	82
113 91 0638	De Bakey nůžky tvrdokovové; 60°; 18,0 cm	De Bakey scissors TUC; 60°; 18,0 cm	82
113 91 0639	Lexer nůžky rovné tvrdokovové; 16,0 cm	Lexer scissors TUC; 16,0 cm	84
113 91 0640	Lexer nůžky zahnuté tvrdokovové; 16,0 cm	Lexer scissors TUC; 16,0 cm	84
113 91 0645	Metzenbaum-Delicate nůžky tupé rovné tvrdokov; 18,0 cm	Metzenbaum-Delicate scissors TUC; 18,0 cm	83

číslo – number	název	item	strana – page
113 91 0646	Metzenbaum-Delicate nůžky tupé rovné tvrdokov; 20,0 cm	Metzenbaum-Delicate scissors TUC; 20,0 cm	83
113 91 0647	Metzenbaum-Delicate nůžky tupé rovné tvrdokov; 23,0 cm	Metzenbaum-Delicate scissors TUC; 23,0 cm	83
113 91 0648	Metzenbaum-Delicate nůžky tupé rovné tvrdokov; 25,0 cm	Metzenbaum-Delicate scissors TUC; 25,0 cm	83
113 91 0649	Metzenbaum-Delicate nůžky tupé rovné tvrdokov; 28,0 cm	Metzenbaum-Delicate scissors TUC; 28,0 cm	83
113 91 0650	Metzenbaum-Delicate nůžky tupé zahnuté tvrdokov; 18,0 cm	Metzenbaum-Delicate scissors TUC; 18,0 cm	83
113 91 0651	Metzenbaum-Delicate nůžky tupé zahnuté tvrdokov; 20,0 cm	Metzenbaum-Delicate scissors TUC; 20,0 cm	83
113 91 0652	Metzenbaum-Delicate nůžky tupé zahnuté tvrdokov; 23,0 cm	Metzenbaum-Delicate scissors TUC; 23,0 cm	83
113 91 0653	Metzenbaum-Delicate nůžky tupé zahnuté tvrdokov; 25,0 cm	Metzenbaum-Delicate scissors TUC; 25,0 cm	83
113 91 0654	Metzenbaum-Delicate nůžky tupé zahnuté tvrdokov; 28,0 cm	Metzenbaum-Delicate scissors TUC; 28,0 cm	83
113 91 0665	Toennis-Adson-Delicate nůžky jemné zahnuté tvrdokov; 17,5 cm	Toennis-Adson-Delicate scissors delicate TUC; 17,5 cm	84
113 91 0668	Nůžky na duhovku hrotnaté rovné tvrdokov; 11,5 cm	Iris scissors TUC; 11,5 cm	84
113 91 0669	Nůžky na duhovku hrotnaté zahnuté tvrdokov; 11,5 cm	Iris scissors TUC; 11,5 cm	84
113 91 0670	Universal nůžky na drát tvrdokov; 12,0 cm	Universal wire shears TUC; 12,0 cm	84
113 91 0671	Lister nůžky na obvazy tvrdokov; 18,0 cm	Lister bandage scissors TUC; 18,0 cm	84
113 91 0685	Stille nůžky micro super cut rovné; 10 cm	Stille scissors micro super cut straight; 10 cm	75
113 91 0686	Stille nůžky micro super cut zahnuté; 10 cm	Stille scissors micro super cut curved; 10 cm	75
113 91 0687	Jabaley-Stille nůžky micro super cut rovné; 12 cm	Jabaley-Stille scissors micro super cut straight; 12 cm	75
113 91 0688	Jabaley-Stille nůžky micro super cut zahnuté; 12 cm	Jabaley-Stille scissors micro super cut curved; 12 cm	75
113 91 0689	Stevens nůžky micro super cut rovné; 12,5 cm	Stevens scissors micro super cut straight; 12,5 cm	75
113 91 0690	Stevens nůžky micro super cut zahnuté; 12,5 cm	Stevens scissors micro super cut curved; 12,5 cm	75
113 91 0691	Lister (bandage) nůžky micro super cut zahnuté; 14 cm	Lister (bandage) scissors micro super cut curved; 14 cm	75
113 91 0692	Mayo-Stille nůžky micro super cut; 15 cm	Mayo-Stille scissors micro super cut; 15 cm	76
113 91 0693	Mayo-Stille nůžky micro super cut zahnuté; 15 cm	Mayo-Stille scissors micro super cut curved; 15 cm	76
113 91 0694	Stille-Mayo nůžky micro super cut; 15 cm	Stille-Mayo scissors micro super cut; 15 cm	76
113 91 0695	Stille-Mayo nůžky micro super cut; 17 cm	Stille-Mayo scissors micro super cut; 17 cm	76
113 91 0696	Stille-Mayo nůžky micro super cut zahnuté; 15 cm	Stille-Mayo scissors micro super cut curved; 15 cm	76
113 91 0697	Stille-Mayo nůžky micro super cut zahnuté; 17 cm	Stille-Mayo scissors micro super cut curved; 17 cm	76
113 91 0698	Mayo-Harrington nůžky micro super cut; 23 cm	Mayo-Harrington scissors micro super cut; 23 cm	76
113 91 0699	Mayo-Harrington nůžky micro super cut; 20 cm	Mayo-Harrington scissors micro super cut; 20 cm	76
113 91 0700	Stille-Rangell nůžky micro super cut zahnuté; 12,5 cm	Stille-Rangell scissors micro super cut curved; 12,5 cm	76
113 91 0701	Stille-Rangell nůžky micro super cut zahnuté; 15 cm	Stille-Rangell scissors micro super cut curved; 15 cm	76
113 91 0702	Stille-Rangell nůžky micro super cut zahnuté; 18 cm	Stille-Rangell scissors micro super cut curved; 18 cm	76
113 91 0703	Stille-Rangell nůžky micro super cut zahnuté; 20 cm	Stille-Rangell scissors micro super cut curved; 20 cm	76
113 91 0704	Stille-Rangell nůžky micro super cut zahnuté; 23 cm	Stille-Rangell scissors micro super cut curved; 23 cm	76
113 91 0705	Metzenbaum nůžky micro super cut; 15 cm	Metzenbaum scissors micro super cut; 15 cm	77
113 91 0706	Metzenbaum nůžky micro super cut; 18 cm	Metzenbaum scissors micro super cut; 18 cm	77
113 91 0707	Metzenbaum nůžky micro super cut; 20 cm	Metzenbaum scissors micro super cut; 20 cm	77
113 91 0708	Metzenbaum nůžky micro super cut; 23 cm	Metzenbaum scissors micro super cut; 23 cm	77
113 91 0709	Metzenbaum nůžky micro super cut; 26 cm	Metzenbaum scissors micro super cut; 26 cm	77
113 91 0710	Metzenbaum nůžky micro super cut zahnuté; 15 cm	Metzenbaum scissors micro super cut bent; 15 cm	77
113 91 0711	Metzenbaum nůžky micro super cut zahnuté; 18 cm	Metzenbaum scissors micro super cut bent; 18 cm	77
113 91 0712	Metzenbaum nůžky micro super cut zahnuté; 20 cm	Metzenbaum scissors micro super cut bent; 20 cm	77
113 91 0713	Metzenbaum nůžky micro super cut zahnuté; 23 cm	Metzenbaum scissors micro super cut bent; 23 cm	77
113 91 0714	Metzenbaum nůžky micro super cut zahnuté; 26 cm	Metzenbaum scissors micro super cut bent; 26 cm	77
113 91 0715	Baby Metzenbaum nůžky micro super cut rovné; 12,5 cm	Baby Metzenbaum scissors micro super cut straight; 12,5 cm	77
113 91 0716	Baby Metzenbaum nůžky micro super cut zahnuté; 12,5 cm	Baby Metzenbaum scissors micro super cut bent; 12,5 cm	77
113 91 0717	Iris nůžky micro super cut rovné; 11,5 cm	Iris scissors micro super cut straight; 11,5 cm	78
113 91 0718	Iris nůžky micro super cut zahnuté; 11,5 cm	Iris scissors micro super cut bent; 11,5 cm	78
113 91 0719	Iris nůžky micro super cut rovné TC; 11,5 cm	Iris scissors micro super cut straight TC; 11,5 cm	78
113 91 0720	Iris nůžky micro super cut zahnuté TC; 11,5 cm	Iris scissors micro super cut bent TC; 11,5 cm	78
113 91 0721	La Grange nůžky micro super cut; 11,5 cm	La Grange scissors micro super cut; 11,5 cm	78
113 91 0722	La Grange nůžky micro super cut; 11,5 cm	La Grange scissors micro super cut; 11,5 cm	78
114	PINZETY	FORCEPS	
114 02 0010	Kuehne pinzeta pro mikroskopická sklíčka; 10,5 cm	Kuehne clamp for microscopic slides; 10,5 cm	87
114 06 0010	Hegenbarth pinzeta svorkovací křížová; 12,0 cm	Hegenbarth forceps for clips; 12,0 cm	401
114 06 0110	Hegenbarth pinzeta svorkovací křížová zahnutá; 11,0 cm	Hegenbarth forceps for clips; 11,0 cm	401
114 08 0030	Pinzeta anatomická; 16,0 cm	Dressing forceps; 16,0 cm	88
114 08 0040	Pinzeta anatomická; 20,0 cm	Dressing forceps; 20,0 cm	88
114 08 0050	Pinzeta anatomická; 25,0 cm	Dressing forceps; 25,0 cm	88
114 08 0060	Pinzeta anatomická; 30,0 cm	Dressing forceps; 30,0 cm	88
114 08 0090	Pinzeta anatomická rovná hladká; 14,5 cm	Dressing forceps; 14,5 cm	90
114 08 0101	Pinzeta anatomická rovná jemná matovaná; 14,5 cm	Dressing forceps; 14,5 cm	89
114 08 0140	Pinzeta anatomická jemná; 20,0 cm	Dressing forceps; 20,0 cm	90
114 08 0231	Pinzeta anatomická velmi jemná matovaná; 14,5 cm	Dressing forceps; 14,5 cm	90
114 08 0240	Pinzeta anatomická velmi jemná; 20,0 cm	Dressing forceps; 20,0 cm	90
114 08 0250	Pinzeta anatomická velmi jemná; 25,0 cm	Dressing forceps; 25,0 cm	90
114 08 0340	Pinzeta chirurgická; 1×2 zuby; 20,0 cm	Tissue forceps; 1×2 teeth; 20,0 cm	88
114 08 0350	Pinzeta chirurgická; 1×2 zuby; 25,0 cm	Tissue forceps; 1×2 teeth; 25,0 cm	88
114 08 0360	Pinzeta chirurgická; 1×2 zuby; 30,0 cm	Tissue forceps; 1×2 teeth; 30,0 cm	88
114 08 0381	Pinzeta chirurgická matovaná; 1×2 zuby; 14,5 cm	Tissue forceps; 1×2 teeth; 14,5 cm	88, 451
114 08 0430	Pinzeta chirurgická jemná; 1×2 zuby; 16,0 cm	Tissue forceps; 1×2 teeth; 16,0 cm	88

číslo – number	název	item	strana – page
114 08 0530	Pinzeta chirurgická velmi jemná; 1×2 zuby; 14,5 cm	Tissue forceps; 1×2 teeth; 14,5 cm	91
114 08 0540	Pinzeta chirurgická velmi jemná; 1×2 zuby; 20,2 cm	Tissue forceps; 1×2 teeth; 20,2 cm	91
114 08 0620	Pinzeta chirurgická; 3×4 zuby; 14,0 cm	Tissue forceps; 3×4 teeth; 14,0 cm	91
114 08 0660	Pinzeta chirurgická; 4×5 zubů; 14,0 cm	Tissue forceps; 4×5 teeth; 14,0 cm	91
114 08 0980	Pinzeta na třísky; 14,0 cm	Splinter forceps; 14,0 cm	98
114 08 1020	Pinzeta technická; 13,5 cm	Technical forceps; 13,5 cm	98
114 08 1030	Pinzeta technická; 19,0 cm	Technical forceps; 19,0 cm	98
114 08 1040	Pinzeta technická; 24,0 cm	Technical forceps; 24,0 cm	98
114 08 1350	Pinzeta anatomická rovná s prodlouž. perem mat.; 14,5 cm	Dressing forceps; 14,5 cm	92, 441
114 08 1470	Pinzeta bipolární bajonetová; 1,2 mm; 25,5 cm	Bipolar forceps bay-shaped; 1,2 mm; 25,5 cm	108
114 08 1480	Pinzeta bipolární bajonetová; 0,7 mm; 25,5 cm	Bipolar forceps bay-shaped; 0,7 mm; 25,5 cm	108
114 08 1490	Pinzeta bipolární bajonetová; 2,0 mm; 25,5 cm	Bipolar forceps bay-shaped; 2,0 mm; 25,5 cm	108
114 08 1500	Pinzeta bipolární rovná; 2,0 mm; 19,5 cm	Bipolar forceps; 2,0 mm; 19,5 cm	108
114 08 1510	Pinzeta bipolární rovná; 1,2 mm; 19,5 cm	Bipolar forceps; 1,2 mm; 19,5 cm	108
114 08 1530	Pinzeta bipolární zahnutá; 2,0 mm; 19,3 cm	Bipolar forceps; 2,0 mm; 19,3 cm	108
114 08 1540	Pinzeta bipolární zahnutá; 1,2 mm; 19,3 cm	Bipolar forceps; 1,2 mm; 19,3 cm	108
114 08 1560	Pinzeta bipolární rovná; 2,0 mm; 16,5 cm	Bipolar forceps; 2,0 mm; 16,5 cm	108
114 08 1570	Pinzeta bipolární rovná; 1,2 mm; 16,5 cm	Bipolar forceps; 1,2 mm; 16,5 cm	108
114 08 1580	Pinzeta bipolární rovná; 0,7 mm; 16,5 cm	Bipolar forceps; 0,7 mm; 16,5 cm	108
114 08 1690	Pinzeta bipolární zahnutá; 2,0 mm; 16,3 cm	Bipolar forceps; 2,0 mm; 16,3 cm	108
114 08 1700	Pinzeta bipolární zahnutá; 1,2 mm; 16,3 cm	Bipolar forceps; 1,2 mm; 16,3 cm	108
114 08 1710	Pinzeta bipolární zahnutá; 0,7 mm; 16,3 cm	Bipolar forceps; 0,7 mm; 16,3 cm	108
114 08 1720	Pinzeta bipolární rovná; 0,7 mm; 11,5 cm	Bipolar forceps; 0,7 mm; 11,5 cm	108
114 08 1730	Pinzeta bipolární rovná; 0,4 mm; 11,5 cm	Bipolar forceps; 0,4 mm; 11,5 cm	108
114 08 1750	Pinzeta bipolární zahnutá; 0,7 mm; 11,3 cm	Bipolar forceps; 0,7 mm; 11,3 cm	108
114 08 1760	Pinzeta bipolární zahnutá; 0,4 mm; 11,3 cm	Bipolar forceps; 0,4 mm; 11,3 cm	108
114 12 0010	Pinzeta na plastiku šicí; 6×5 zubů; 14,0 cm	Suturing forceps; 6×5 teeth; 14,0 cm	87
114 12 0020	Pinzeta jemná šicí; 20,0 cm	Suturing forceps; 20,0 cm	87
114 12 0030	Pinzeta na plastiku šicí; 3×4 zuby; 10,8 cm	Suturing forceps; 3×4 teeth; 10,8 cm	87
114 12 0090	Pinzeta epilační široká; 13,0 cm	Depilation forceps; 13,0 cm	87
114 12 0100	Pinzeta epilační; 14,3 cm	Depilation forceps; 14,3 cm	87
114 14 0100	Pinzeta cévní atraumatická rovná; 2,0 mm; 14,5 cm	Non-traumatic forceps; 2,0 mm; 14,5 cm	106
114 14 0110	Pinzeta cévní atraumatická rovná; 2,0 mm; 20,0 cm	Non-traumatic forceps; 2,0 mm; 20,0 cm	106
114 14 0120	Pinzeta cévní atraumatická zahnutá; 2,0 mm; 19,8 cm	Non-traumatic forceps; 2,0 mm; 19,8 cm	106
114 14 0130	Pinzeta cévní atraumatická; 3,5 mm; 20,0 cm	Non-traumatic forceps; 3,5 mm; 20,0 cm	106
114 14 0140	Pinzeta cévní atraumatická; 3,5 mm; 24,8 cm	Non-traumatic forceps; 3,5 mm; 24,8 cm	106
114 14 0300	Pinzeta cévní atraumatická rovná jemná; 14,5 cm	Non-traumatic forceps; 14,5 cm	106
114 29 0010	Troeltsch pinzeta ušní jemná; 11,0 cm	Troeltsch ear forceps; 11,0 cm	99
114 29 0020	Troeltsch pinzeta ušní; 11,0 cm	Troeltsch ear forceps; 11,0 cm	99
114 29 0030	Lucae pinzeta ušní bajonetová anatomická; 14,5 cm	Lucae ear anatomical forceps; 14,5 cm	99
114 30 0010	Troeltsch pinzeta nosní jemná; 16,0 cm	Troeltsch nasal forceps; 16,0 cm	99
114 30 0020	Troeltsch pinzeta nosní; 18,0 cm	Troeltsch nasal forceps; 18,0 cm	99
114 30 0040	Pinzeta bajonetová anatomická; 18,0 cm	Anatomical forceps; 18,0 cm	99
114 32 0010	Maršik pinzeta na mandle; 22,8 cm	Maršik tonsil forceps; 22,8 cm	99
114 38 0010	Graefe pinzeta oční rovná; 10,5 cm	Graefe eye forceps; 10,5 cm	100
114 38 0020	Graefe pinzeta oční rovná jemná; 10,5 cm	Graefe eye forceps; 10,5 cm	100
114 38 0030	Graefe pinzeta oční rovná nemagnetická; 10,5 cm	Graefe eye forceps; 10,5 cm	100
114 38 0040	Graefe pinzeta oční rovná nemagnetická jemná; 10,5 cm	Graefe eye forceps; 10,5 cm	100
114 38 0100	Graefe pinzeta oční zahnutá jemná; 10,5 cm	Graefe eye forceps; 10,5 cm	100
114 38 0110	Graefe pinzeta oční silně zahnutá; 10,0 cm	Graefe eye forceps; 10,0 cm	100
114 38 0120	Graefe pinzeta oční silně zahnutá nemagnetická; 10,0 cm	Graefe eye forceps; 10,0 cm	100
114 38 0150	Graefe pinzeta oční rovná; 1×2 zuby; 10,5 cm	Graefe eye forceps; 1×2 teeth; 10,5 cm	100
114 38 0160	Graefe pinzeta oční rovná jemná; 1×2 zuby; 10,5 cm	Graefe eye forceps; 1×2 teeth; 10,5 cm	100
114 38 0170	Graefe pinzeta oční rovná nemagnetická; 1×2 zuby; 10,5 cm	Graefe eye forceps; 1×2 teeth; 10,5 cm	100
114 38 0200	Graefe pinzeta oční zahnutá; 1×2 zuby; 10,5 cm	Graefe eye forceps; 1×2 teeth; 10,5 cm	100
114 38 0210	Graefe pinzeta oční silně zah. nemagnet.; 1×2 zuby; 10,0 cm	Graefe eye forceps; 1×2 teeth; 10,0 cm	100
114 38 0230	Koutný pinzeta na duhovku zahnutá; 10,0 cm	Koutný iris forceps; 10,0 cm	101
114 38 0250	Pinzeta na duhovku anatomická; 4,8 cm	Iris forceps; 4,8 cm	101
114 38 0270	Pinzeta na duhovku chirurgická zahnutá; 4,8 cm	Iris forceps; 4,8 cm	101
114 38 0350	Graefe pinzeta fixační; 11,0 cm	Graefe fixation forceps; 11,0 cm	101
114 38 0360	Graefe pinzeta fixační s uzávěrem s perem; 11,0 cm	Graefe fixation forceps; 11,0 cm	101
114 38 0370	Elschnig pinzeta fixační; 10,5 cm	Elschnig fixation forceps; 10,5 cm	101
114 38 0590	Kuhnt pinzeta na čočkové pouzdro; 10,2 cm	Kuhnt capsule forceps; 10,2 cm	102
114 38 0600	Elschnig pinzeta na čočkové pouzdro fig.1; 10,7 cm	Elschnig capsule forceps fig.1; 10,7 cm	102
114 38 0610	Elschnig pinzeta na čočkové pouzdro fig.2; 10,7 cm	Elschnig capsule forceps fig.2; 10,7 cm	102
114 38 0620	Arruga pinzeta na čočkové pouzdro; 10,8 cm	Arruga capsule forceps; 10,8 cm	102
114 38 0630	Kalt pinzeta na čočkové pouzdro; 10,2 cm	Kalt capsule forceps; 10,2 cm	102
114 38 0640	Bonefone pinzeta na čočkové pouzdro; 10,7 cm	Bonefone capsule forceps; 10,7 cm	103
114 38 0650	Verhoff pinzeta na čočkové pouzdro; 10,6 cm	Verhoff capsule forceps; 10,6 cm	103
114 38 0720	Kolibří pinzeta na duhovku šicí; 8,0 cm	Kolibří iris forceps; 8,0 cm	103
114 38 0750	Pinzeta enukleační 4×5 zubů; 14,0 cm	Enucleation forceps; 14,0 cm	103

číslo – number	název	item	strana – page
114 38 0810	Pinzeta na operaci šilhání se zámkem pravá; 9,5 cm	Strabismus forceps; 9,5 cm	104
114 38 0820	Pinzeta na operaci šilhání se zámkem levá; 9,5 cm	Strabismus forceps; 9,5 cm	104
114 38 0830	Blascovics pinzeta na operaci šilhání se šroubem pr.; 9,5 cm	Blascovics strabismus forceps; 9,5 cm	104
114 38 0840	Blascovics pinzeta na operaci šilhání se šroubem lev.; 9,5 cm	Blascovics strabismus forceps; 9,5 cm	104
114 38 0850	Castroviejo pinzeta na rohovku; 10,0 cm	Castroviejo corneal forceps; 10,0 cm	104
114 38 0860	Pinzeta na rohovku šicí rovná; 10,0 cm	Corneal suturing forceps; 10,0 cm	104
114 38 0870	Pinzeta na rohovku zahnutá; 10,0 cm	Corneal suturing forceps; 10,0 cm	104
114 38 0910	Desmarres pinzeta na chalazia fig.1	Desmarres chalazion forceps fig.1	104
114 38 0920	Desmarres pinzeta na chalazia fig.2	Desmarres chalazion forceps fig.2	104
114 38 0930	Desmarres pinzeta na chalazia fig.3	Desmarres chalazion forceps fig.3	104
114 38 0950	Desmarres pinzeta na chalazia fig.5	Desmarres chalazion forceps fig.5	104
114 38 1110	Beer pinzeta na řasy; 3×85 mm	Beer cilia forceps; 3×85 mm	105
114 38 1120	Beer pinzeta na řasy; 4,5 mm	Beer cilia forceps; 4,5 mm	105
114 38 1170	Pinzeta na řasy zkosená; 8,7 cm	Cilia forceps; 8,7 cm	105
114 38 1230	Pinzeta na keratoplastiku vidlič. lomená; 8,5 cm	Keratoplastic forceps; 8,5 cm	105
114 38 1260	Kalt pinzeta na čokové pouzdro mikro; 9,5 cm	Kalt capsule micro forceps; 9,5 cm	105
114 38 1300	Kolibri pinzeta na duhovku mikro; 8,0 cm	Kolibri iris micro forceps; 8,0 cm	105
114 38 1310	Pinzeta šicí rovná hladká; 8,5 cm	Suturing forceps; 8,5 cm	105
114 38 1320	Pinzeta šicí rovná háčková; 8,5 cm	Suturing forceps; 8,5 cm	105
114 38 1330	Pinzeta šicí prohnutá háčková; 8,2 cm	Suturing forceps; 8,2 cm	105
114 91 0002	Pinzeta anatomická rovná; 11,5 cm	Standard dressing forceps; 11,5 cm	88
114 91 0003	Pinzeta anatomická rovná; 13,0 cm	Standard dressing forceps; 13,0 cm	88
114 91 0004	Pinzeta anatomická rovná; 14,5 cm	Standard dressing forceps; 14,5 cm	88
114 91 0006	Pinzeta anatomická rovná; 18,0 cm	Standard dressing forceps; 18,0 cm	88
114 91 0011	Pinzeta chirurgická rovná; 1×2 zuby; 11,5 cm	Standard tissue forceps; 1×2 teeth; 11,5 cm	88
114 91 0012	Pinzeta chirurgická rovná; 1×2 zuby; 13,0 cm	Standard tissue forceps; 1×2 teeth; 13,0 cm	88
114 91 0015	Pinzeta chirurgická rovná; 1×2 zuby; 18,0 cm	Standard tissue forceps; 1×2 teeth; 18,0 cm	88
114 91 0019	Pinzeta chirurgická rovná; 2×3 zuby; 13,0 cm	Tissue forceps; 2×3 teeth; 13,0 cm	89
114 91 0020	Pinzeta chirurgická rovná; 2×3 zuby; 14,5 cm	Tissue forceps; 2×3 teeth; 14,5 cm	89
114 91 0021	Pinzeta chirurgická rovná; 2×3 zuby; 16,0 cm	Tissue forceps; 2×3 teeth; 16,0 cm	89
114 91 0022	Pinzeta chirurgická rovná; 2×3 zuby; 18,0 cm	Tissue forceps; 2×3 teeth; 18,0 cm	89
114 91 0023	Pinzeta chirurgická rovná; 2×3 zuby; 20,0 cm	Tissue forceps; 2×3 teeth; 20,0 cm	89
114 91 0024	Pinzeta chirurgická rovná; 2×3 zuby; 25,0 cm	Tissue forceps; 2×3 teeth; 25,0 cm	89
114 91 0026	Pinzeta chirurgická rovná; 3×4 zuby; 13,0 cm	Tissue forceps; 3×4 teeth; 13,0 cm	89
114 91 0027	Pinzeta chirurgická rovná; 3×4 zuby; 14,5 cm	Tissue forceps; 3×4 teeth; 14,5 cm	89
114 91 0028	Pinzeta chirurgická rovná; 3×4 zuby; 16,0 cm	Tissue forceps; 3×4 teeth; 16,0 cm	89
114 91 0029	Pinzeta chirurgická rovná; 4×5 zubů; 13,0 cm	Tissue forceps; 4×5 teeth; 13,0 cm	89
114 91 0030	Pinzeta chirurgická rovná; 4×5 zubů; 14,5 cm	Tissue forceps; 4×5 teeth; 14,5 cm	89
114 91 0031	Pinzeta chirurgická rovná; 4×5 zubů; 16,0 cm	Tissue forceps; 4×5 teeth; 16,0 cm	89
114 91 0033	Pinzeta anatomická úzká; 11,5 cm	Dressing forceps; 11,5 cm	89
114 91 0034	Pinzeta anatomická úzká; 13,0 cm	Dressing forceps; 13,0 cm	89
114 91 0036	Pinzeta anatomická úzká; 16,0 cm	Dressing forceps; 16,0 cm	89
114 91 0037	Pinzeta anatomická úzká; 18,0 cm	Dressing forceps; 18,0 cm	89
114 91 0038	Pinzeta anatomická úzká; 20,0 cm	Dressing forceps; 20,0 cm	89
114 91 0039	Pinzeta anatomická úzká; 25,0 cm	Dressing forceps; 25,0 cm	89
114 91 0040	Pinzeta anatomická úzká; 30,0 cm	Dressing forceps; 30,0 cm	89
114 91 0105	Adson pinzeta anatomická; 12,0 cm	Adson dressing forceps; 12,0 cm	92
114 91 0107	Adson pinzeta anatomická; 15,0 cm	Adson dressing forceps; 15,0 cm	92
114 91 0108	Micro-Adson pinzeta anatomická; 12,0 cm	Micro-Adson dressing forceps; 12,0 cm	92
114 91 0111	Adson pinzeta chirurgická; 1×2 zuby; 12,0 cm	Adson tissue forceps; 1×2 teeth; 12,0 cm	92
114 91 0113	Adson pinzeta chirurgická; 1×2 zuby; 15,0 cm	Adson tissue forceps; 1×2 teeth; 15,0 cm	92
114 91 0114	Micro-Adson pinzeta chirurgická; 1×2 zuby; 12,0 cm	Micro-Adson tissue forceps; 1×2 teeth; 12,0 cm	92
114 91 0119	Adson-Brown pinzeta chirurgická rovná; 7×7 zuby; 12,0 cm	Adson-Brown tissue forceps; 7×7 teeth; 12,0 cm	92
114 91 0126	McIndoe pinzeta anatomická; 15,0 cm	McIndoe dressing forceps; 15,0 cm	92
114 91 0128	Semken pinzeta anatomická rovná; 12,5 cm	Semken dressing forceps; 12,5 cm	92
114 91 0129	Semken pinzeta anatomická rovná; 15,5 cm	Semken dressing forceps; 15,5 cm	92
114 91 0132	Semken pinzeta chirurgická rovná; 1×2 zuby; 12,5 cm	Semken tissue forceps; 1×2 teeth; 12,5 cm	92
114 91 0133	Semken pinzeta chirurgická rovná; 1×2 zuby; 15,5 cm	Semken tissue forceps; 1×2 teeth; 15,5 cm	92
114 91 0138	Taylor pinzeta anatomická rovná; 17,5 cm	Taylor dressing forceps with dissector; 17,5 cm	93
114 91 0139	Taylor pinzeta anatomická bajonetová; 17,5 cm	Taylor dressing forceps with dissector; 17,5 cm	93
114 91 0142	Taylor pinzeta chirurgická rovná; 1×2 zuby 17,5 cm	Taylor tissue forceps with dissector; 1×2 teeth; 17,5 cm	93
114 91 0143	Taylor pinzeta chirurgická bajonetová; 17,5 cm	Taylor tissue forceps with dissector; 17,5 cm	93
114 91 0144	Lane pinzeta chirurgická; 1×2 zuby; 14,5 cm	Lane tissue forceps; 1×2 teeth; 14,5 cm	93
114 91 0146	Lane pinzeta chirurgická; 2×3 zuby; 14,5 cm	Lane tissue forceps; 2×3 teeth; 14,5 cm	93
114 91 0148	Gerald pinzeta anatomická rovná; 18,0 cm	Gerald dressing forceps; 18,0 cm	94
114 91 0149	Gerald pinzeta anatomická zahnutá; 18,0 cm	Gerald dressing forceps; 18,0 cm	94
114 91 0150	Gerald pinzeta chirurgická rovná; 1×2 zuby; 17,0 cm	Gerald tissue forceps; 1×2 teeth; 17,0 cm	94
114 91 0151	Gerald pinzeta chirurgická zahnutá; 1×2 zuby; 17,0 cm	Gerald tissue forceps; 1×2 teeth; 17,0 cm	94
114 91 0152	Cushing pinzeta anatomická rovná; 17,5 cm	Cushing dressing forceps; 17,5 cm	93
114 91 0154	Cushing pinzeta chirurgická rovná; 1×2 zuby; 17,5 cm	Cushing tissue forceps; 1×2 teeth; 17,5 cm	93
114 91 0156	Potts-Smith pinzeta anatomická rovná; 18,0 cm	Potts-Smith dressing forceps; 18,0 cm	94

číslo – number	název	item	strana – page
114 91 0157	Potts-Smith pinzeta anatomická rovná; 21,0 cm	Potts-Smith dressing forceps; 21,0 cm	94
114 91 0158	Potts-Smith pinzeta anatomická rovná; 25,0 cm	Potts-Smith dressing forceps; 25,0 cm	94
114 91 0162	Potts-Smith pinzeta chirurgická rovná; 1×2 zuby; 18,0 cm	Potts-Smith tissue forceps; 1×2 teeth; 18,0 cm	94
114 91 0163	Potts-Smith pinzeta chirurgická rovná; 1×2 zuby; 21,0 cm	Potts-Smith tissue forceps; 1×2 teeth; 21,0 cm	94
114 91 0164	Potts-Smith pinzeta chirurgická rovná; 1×2 zuby; 25,0 cm	Potts-Smith tissue forceps; 1×2 teeth; 25,0 cm	94
114 91 0172	Brown pinzeta chirurgická; 15,0 cm	Brown tissue forceps; 15,0 cm	94
114 91 0173	Brown pinzeta chirurgická; 20,0 cm	Brown tissue forceps; 20,0 cm	94
114 91 0174	Brown pinzeta chirurgická; 25,0 cm	Brown tissue forceps; 25,0 cm	94
114 91 0179	Wangensteen pinzeta anatomická; 23,0 cm	Wangensteen dressing forceps; 23,0 cm	95
114 91 0180	Stille-Barraya pinzeta chirurgická; 3×4 zuby; 18,0 cm	Stille-Barraya tissue forceps; 3×4 teeth; 18,0 cm	95
114 91 0181	Stille-Barraya pinzeta chirurgická; 3×4 zuby; 20,0 cm	Stille-Barraya tissue forceps; 3×4 teeth; 20,0 cm	95
114 91 0182	Stille-Barraya pinzeta chirurgická; 3×4 zuby; 25,0 cm	Stille-Barraya tissue forceps; 3×4 teeth; 25,0 cm	95
114 91 0183	Ferris-Smith pinzeta chirurgická; 2×3 zuby; 18,0 cm	Ferris-Smith tissue forceps; 2×3 teeth; 18,0 cm	95
114 91 0190	Adlerkreutz pinzeta chirurgická; 4×5 zuby; 15,0 cm	Adlerkreutz tissue forceps; 4×5 teeth; 15,0 cm	95
114 91 0191	Adlerkreutz pinzeta chirurgická; 4×5 zuby; 20,0 cm	Adlerkreutz tissue forceps; 4×5 teeth; 20,0 cm	95
114 91 0193	Collin-Duval pinzeta úchopná; 14 mm; 20,0 cm	Collin-Duval grasping forceps; 14 mm; 20,0 cm	95
114 91 0198	Singley-Tuttle pinzeta chirurgická; 1×2 zuby; 15,0 cm	Singley-Tuttle tissue forceps; 1×2 teeth; 15,0 cm	96
114 91 0199	Nelson pinzeta úchopná; 23,0 cm	Nelson grasping forceps; 23,0 cm	96
114 91 0200	Gillies pinzeta chirurgická; 1×2 zuby; 15,0 cm	Gillies tissue forceps; 1×2 teeth; 15,0 cm	96
114 91 0208	Russ. Modell pinzeta chirurgická; 15,0 cm	Russ. Modell tissue forceps; 15,0 cm	96
114 91 0209	Russ. Modell pinzeta chirurgická; 20,0 cm	Russ. Modell tissue forceps; 20,0 cm	96
114 91 0210	Russ. Modell pinzeta chirurgická; 25,0 cm	Russ. Modell tissue forceps; 25,0 cm	96
114 91 0211	Durante pinzeta chirurgická; 14,5 cm	Durante tissue forceps; 14,5 cm	96
114 91 0212	Durante pinzeta chirurgická; 16,0 cm	Durante tissue forceps; 16,0 cm	96
114 91 0213	Durante pinzeta chirurgická; 20,0 cm	Durante tissue forceps; 20,0 cm	96
114 91 0214	Duval pinzeta chirurgická; 14,5 cm	Duval tissue forceps; 14,5 cm	96
114 91 0215	Bonney pinzeta chirurgická; 1×2 zuby; 18,0 cm	Bonney tissue forceps; 1×2 teeth; 18,0 cm	96
114 91 0216	Bonney pinzeta chirurgická; 2×3 zuby; 18,0 cm	Bonney tissue forceps; 2×3 teeth; 18,0 cm	96
114 91 0228	Yasargil pinzeta na nádory; 3 mm dia; 22,0 cm	Yasargil tumor forceps; 3 mm dia; 22,0 cm	97
114 91 0229	Yasargil pinzeta na nádory; 5 mm dia; 22,0 cm	Yasargil tumor forceps; 5 mm dia; 22,0 cm	97
114 91 0230	Yasargil pinzeta na nádory; 3 mm dia; 22,0 cm	Yasargil tumor forceps; 3 mm dia; 22,0 cm	97
114 91 0231	Yasargil pinzeta na nádory; 5 mm dia; 22,0 cm	Yasargil tumor forceps; 5 mm dia; 22,0 cm	97
114 91 0255	Pinzeta šicí rovná; 0,3 mm; 12,0 cm	Suture tying forceps; 0,3 mm; 12,0 cm	97
114 91 0256	Pinzeta šicí rovná; 0,3 mm; 15,0 cm	Suture tying forceps; 0,3 mm; 15,0 cm	97
114 91 0257	Pinzeta šicí zahnutá; 0,3 mm; 12,0 cm	Suture tying forceps; 0,3 mm; 12,0 cm	97
114 91 0258	Pinzeta šicí zahnutá; 0,3 mm; 15,0 cm	Suture tying forceps; 0,3 mm; 15,0 cm	97
114 91 0259	Pinzeta šicí rovná; 0,3 mm; 18,0 cm	Suture tying forceps; 0,3 mm; 18,0 cm	97
114 91 0260	Pinzeta šicí zahnutá; 0,3 mm; 18,0 cm	Suture tying forceps; 0,3 mm; 18,0 cm	97
114 91 0318	Stieglitz pinzeta na třísky rovná; 13,5 cm	Stieglitz splinter forceps; 13,5 cm	98
114 91 0319	Stieglitz pinzeta na třísky zahnutá; 13,5 cm	Stieglitz splinter forceps; 13,5 cm	98
114 91 0323	Peet pinzeta na třísky zahnutá; 11,5 cm	Peet splinter forceps; 11,5 cm	98
114 91 0366	Graefe pinzeta oční rovná; 10,0 cm	Graefe eye forceps; 10,0 cm	100
114 91 0368	Graefe pinzeta oční mírně zahnutá; 10,0 cm	Graefe eye forceps; 10,0 cm	100
114 91 0372	Graefe pinzeta oční rovná; 1×2 zuby; 10,0 cm	Graefe eye forceps; 1×2 teeth; 10,0 cm	100
114 91 0374	Graefe pinzeta oční mírně zahnutá; 1×2 zuby; 10,0 cm	Graefe eye forceps; 1×2 teeth; 10,0 cm	100
114 91 0451	De Bakey pinzeta atraumatická rovná; 1,5 mm; 16,0 cm	De Bakey atrauma forceps; 1,5 mm; 16,0 cm	107
114 91 0453	De Bakey pinzeta atraumatická rovná; 1,5 mm; 20,0 cm	De Bakey atrauma forceps; 1,5 mm; 20,0 cm	107
114 91 0454	De Bakey pinzeta atraumatická rovná; 1,5 mm; 24,0 cm	De Bakey atrauma forceps; 1,5 mm; 24,0 cm	107
114 91 0455	De Bakey pinzeta atraumatická rovná; 2,0 mm; 16,0 cm	De Bakey atrauma forceps; 2,0 mm; 16,0 cm	107
114 91 0457	De Bakey pinzeta atraumatická rovná; 2,0 mm; 20,0 cm	De Bakey atrauma forceps; 2,0 mm; 20,0 cm	107
114 91 0458	De Bakey pinzeta atraumatická rovná; 2,0 mm; 24,0 cm	De Bakey atrauma forceps; 2,0 mm; 24,0 cm	107
114 91 0459	De Bakey pinzeta atraumatická rovná; 2,0 mm; 30,0 cm	De Bakey atrauma forceps; 2,0 mm; 30,0 cm	107
114 91 0460	De Bakey pinzeta atraumatická rovná; 2,8 mm; 16,0 cm	De Bakey atrauma forceps; 2,8 mm; 16,0 cm	107
114 91 0461	De Bakey pinzeta atraumatická rovná; 2,8 mm; 20,0 cm	De Bakey atrauma forceps; 2,8 mm; 20,0 cm	107
114 91 0462	De Bakey pinzeta atraumatická rovná; 2,8 mm; 24,0 cm	De Bakey atrauma forceps; 2,8 mm; 24,0 cm	107
114 91 0463	De Bakey pinzeta atraumatická rovná; 2,8 mm; 30,0 cm	De Bakey atrauma forceps; 2,8 mm; 30,0 cm	107
114 91 0464	De Bakey pinzeta atraumatická rovná; 3,5 mm; 20,0 cm	De Bakey atrauma forceps; 3,5 mm; 20,0 cm	107
114 91 0465	De Bakey pinzeta atraumatická rovná; 3,5 mm; 24,0 cm	De Bakey atrauma forceps; 3,5 mm; 24,0 cm	107
114 91 0466	De Bakey pinzeta atraumatická rovná; 3,5 mm; 30,0 cm	De Bakey atrauma forceps; 3,5 mm; 30,0 cm	107
114 91 0467	De Bakey pinzeta atraumatická zahnutá; 2,0 mm; 16,0 cm	De Bakey atrauma forceps; 2,0 mm; 16,0 cm	107
114 91 0469	De Bakey pinzeta atraumatická zahnutá; 2,0 mm; 20,0 cm	De Bakey atrauma forceps; 2,0 mm; 20,0 cm	107
114 91 0470	De Bakey pinzeta atraumatická zahnutá; 2,0 mm; 24,0 cm	De Bakey atrauma forceps; 2,0 mm; 24,0 cm	107
114 91 0471	De Bakey pinzeta atraumatická zahnutá; 2,0 mm; 30,0 cm	De Bakey atrauma forceps; 2,0 mm; 30,0 cm	107
114 91 0472	Pinzeta anatomická tvrdokov; 15,0 cm	Forceps TUC; 15,0 cm	109
114 91 0473	Pinzeta anatomická tvrdokov; 18,0 cm	Forceps TUC; 18,0 cm	109
114 91 0474	Pinzeta anatomická tvrdokov; 20,0 cm	Forceps TUC; 20,0 cm	109
114 91 0475	Pinzeta anatomická tvrdokov; 23,0 cm	Forceps TUC; 23,0 cm	109
114 91 0476	Pinzeta anatomická tvrdokov; 25,0 cm	Forceps TUC; 25,0 cm	109
114 91 0477	Oehler pinzeta chirurgická tvrdokov; 1×2 zuby; 14,0 cm	Oehler tissue forceps TUC; 1×2 teeth; 14,0 cm	109
114 91 0478	Oehler pinzeta chirurgická tvrdokov; 1×2 zuby; 16,0 cm	Oehler tissue forceps TUC; 1×2 teeth; 16,0 cm	109
114 91 0479	Oehler pinzeta chirurgická tvrdokov; 1×2 zuby; 18,0 cm	Oehler tissue forceps TUC; 1×2 teeth; 18,0 cm	109

číslo – number	název	item	strana – page
114 91 0480	Oehler pinzeta chirurgická tvrdokov; 1×2 zuby; 20,0 cm	Oehler tissue forceps TUC; 1×2 teeth; 20,0 cm	109
114 91 0481	Oehler pinzeta chirurgická tvrdokov; 1×2 zuby; 25,0 cm	Oehler tissue forceps TUC; 1×2 teeth; 25,0 cm	109
114 91 0482	Oehler pinzeta chirurgická tvrdokov; 1×2 zuby; 30,0 cm	Oehler tissue forceps TUC; 1×2 teeth; 30,0 cm	109
114 91 0483	Semken pinzeta anatomická tvrdokov; 12,5 cm	Semken dissecting forceps TUC; 12,5 cm	109
114 91 0484	Semken pinzeta anatomická tvrdokov; 15,5 cm	Semken dissecting forceps TUC; 15,5 cm	109
114 91 0485	Gillies pinzeta chirurgická tvrdokov; 1×2 zuby; 15,0 cm	Gillies tissue forceps TUC; 1×2 teeth; 15,0 cm	109
114 91 0486	Jeweler pinzeta tvrdokov; 15,0 cm	Jeweler forceps TUC; 15,0 cm	109
114 91 0487	Adson pinzeta anatomická tvrdokov; 12,0 cm	Adson forceps TUC; 12,0 cm	110
114 91 0489	Adson pinzeta anatomická tvrdokov; 15,0 cm	Adson forceps TUC; 15,0 cm	110
114 91 0490	Adson pinzeta chirurgická tvrdokov; 1×2 zuby; 12,0 cm	Adson forceps TUC; 1×2 teeth; 12,0 cm	110
114 91 0491	Adson pinzeta chirurgická tvrdokov; 1×2 zuby; 15,0 cm	Adson forceps TUC; 1×2 teeth; 15,0 cm	110
114 91 0492	Cushing pinzeta anatomická tvrdokov; 17,5 cm	Cushing forceps TUC; 17,5 cm	110
114 91 0493	Cushing pinzeta anatomická zahnutá tvrdokov; 18,0 cm	Cushing forceps TUC; 18,0 cm	110
114 91 0494	Cushing-Taylor pinzeta tvrdokov; 18,0 cm	Cushing-Taylor forceps TUC; 18,0 cm	110
114 91 0495	De Bakey pinzeta atraumatická tvrdokov; 1,5 mm; 16,0 cm	De Bakey atrauma forceps TUC; 1,5 mm; 16,0 cm	110
114 91 0496	De Bakey pinzeta atraumatická tvrdokov; 1,5 mm; 20,0 cm	De Bakey atrauma forceps TUC; 1,5 mm; 20,0 cm	110
114 91 0497	De Bakey pinzeta atraumatická tvrdokov; 1,5 mm; 24,0 cm	De Bakey atrauma forceps TUC; 1,5 mm; 24,0 cm	110
114 91 0498	De Bakey pinzeta atraumatická tvrdokov; 2,0 mm; 16,0 cm	De Bakey atrauma forceps TUC; 2,0 mm; 16,0 cm	110
114 91 0499	De Bakey pinzeta atraumatická tvrdokov; 2,0 mm; 20,0 cm	De Bakey atrauma forceps TUC; 2,0 mm; 20,0 cm	110
114 91 0500	De Bakey pinzeta atraumatická tvrdokov; 2,0 mm; 24,0 cm	De Bakey atrauma forceps TUC; 2,0 mm; 24,0 cm	110
114 91 0501	Bonney pinzeta chirurgická tvrdokov; 1×2 zuby; 18,0 cm	Bonney tissue forceps TUC; 1×2 teeth; 18,0 cm	110
114 91 0502	Wangensteen pinzeta chirurgická tvrdokov; 15,0 cm	Wangensteen tissue forceps TUC; 15,0 cm	110
114 91 0503	Wangensteen pinzeta chirurgická tvrdokov; 23,0 cm	Wangensteen tissue forceps TUC; 23,0 cm	110
115	SVORKY	CLAMPS – FORCEPS	
115 08 0010	Mosquito-Halsted svorka na cévy rovná; 12,0 cm	Mosquito-Halsted artery forceps; 12,0 cm	118
115 08 0020	Mosquito-Halsted svorka na cévy zahnutá; 12,0 cm	Mosquito-Halsted artery forceps; 12,0 cm	118
115 08 0030	Mosquito-Halsted svorka rovná; 1×2 zuby; 12,0 cm	Mosquito-Halsted artery forceps; 1×2 teeth; 12,0 cm	118
115 08 0040	Mosquito-Halsted svorka rovná hladká; 1×2 zuby; 12,0 cm	Mosquito-Halsted artery forceps; 1×2 teeth; 12,0 cm	118
115 08 0050	Mosquito-Halsted svorka zahnutá; 1×2 zuby; 12,0 cm	Mosquito-Halsted artery forceps; 1×2 teeth; 12,0 cm	118
115 08 0060	Mosquito-Halsted svorka zahnutá hladká; 1×2 zuby; 12,0 cm	Mosquito-Halsted artery forceps; 1×2 teeth; 12,0 cm	118
115 08 0071	Pean svorka na cévy rovná; 17,5 cm	Pean artery forceps; 17,5 cm	117
115 08 0121	Rochester-Pean svorka na cévy rovná; 20,0 cm	Rochester-Pean artery forceps; 20,0 cm	124
115 08 0130	Rochester-Pean svorka na cévy rovná; 24,0 cm	Rochester-Pean artery forceps; 24,0 cm	124
115 08 0171	Rochester-Pean svorka na cévy zahnutá; 20,0 cm	Rochester-Pean artery forceps; 20,0 cm	125
115 08 0180	Rochester-Pean svorka na cévy zahnutá; 24,0 cm	Rochester-Pean artery forceps; 24,0 cm	125
115 08 0190	Pean svorka na cévy rovná jemná; 20,0 cm	Pean artery forceps; 20,0 cm	120
115 08 0200	Pean svorka na cévy zahnutá jemná; 20,0 cm	Pean artery forceps; 20,0 cm	120
115 08 0220	Rochester-Pean svorka na cévy rovná; 14,0 cm	Rochester-Pean artery forceps; 14,0 cm	124, 441
115 08 0231	Rochester-Pean svorka na cévy rovná; 16,0 cm	Rochester-Pean artery forceps; 16,0 cm	124, 451
115 08 0260	Rochester-Pean svorka na cévy zahnutá; 14,0 cm	Rochester-Pean artery forceps; 14,0 cm	125
115 08 0271	Rochester-Pean svorka na cévy zahnutá; 16,0 cm	Rochester-Pean artery forceps; 16,0 cm	125
115 08 0331	Kocher svorka na cévy rovná; 20,0 cm	Kocher artery forceps; 20,0 cm	121
115 08 0340	Kocher svorka na cévy rovná; 24,0 cm	Kocher artery forceps; 24,0 cm	121
115 08 0381	Kocher svorka na cévy zahnutá; 20,0 cm	Kocher artery forceps; 20,0 cm	121
115 08 0390	Kocher svorka na cévy zahnutá; 24,0 cm	Kocher artery forceps; 24,0 cm	121
115 08 0410	Kocher svorka na cévy rovná jemná; 20,0 cm	Kocher artery forceps; 20,0 cm	120
115 08 0420	Kocher svorka na cévy zahnutá jemná; 20,0 cm	Kocher artery forceps; 20,0 cm	120
115 08 0500	Kelly svorka na cévy zahnutá; 14,0 cm	Kelly artery forceps; 14,0 cm	122
115 08 0520	Kelly svorka na cévy zahnutá jemná; 22,5 cm	Kelly artery forceps; 22,5 cm	131
115 08 0550	Rochester-Ochsner svorka na cévy rovná; 14,0 cm	Rochester-Ochsner artery forceps; 14,0 cm	121
115 08 0561	Rochester-Ochsner svorka na cévy rovná; 16,0 cm	Rochester-Ochsner artery forceps; 16,0 cm	121
115 08 0590	Rochester-Ochsner svorka na cévy zahnutá; 14,0 cm	Rochester-Ochsner artery forceps; 14,0 cm	121
115 08 0601	Rochester-Ochsner svorka na cévy zahnutá; 16,0 cm	Rochester-Ochsner artery forceps; 16,0 cm	121
115 08 0780	Backhaus svorka s kulíčkou; 11,8 cm	Backhaus forceps; 11,8 cm	188
115 08 0790	Backhaus svorka na papír; 12,0 cm	Backhaus paper forceps; 12,0 cm	188
115 08 0810	Backhaus svorka na prádlo; 8,0 cm	Backhaus towel forceps; 8,0 cm	189
115 08 0820	Backhaus svorka na prádlo; 13,0 cm	Backhaus towel forceps; 13,0 cm	189
115 08 1000	Svorka na uzavírání sáčků s krví; 32,5 cm	Forceps for closing bags; 32,5 cm	191
115 08 1010	Mosquito-Halsted svorka na cévy rovná jemná; 12,0 cm	Mosquito-Halsted artery forceps; 12,0 cm	118
115 08 1020	Mosquito-Halsted svorka na cévy zahnutá jemná; 12,0 cm	Mosquito-Halsted artery forceps; 12,0 cm	118
115 08 1030	Mosquito-Halsted svorka rovná jemná; 1×2 zuby; 12,0 cm	Mosquito-Halsted artery forceps; 1×2 teeth; 12,0 cm	118
115 08 1050	Mosquito-Halsted svorka zahnutá jemná; 1×2 zuby; 12,0 cm	Mosquito-Halsted artery forceps; 1×2 teeth; 12,0 cm	118
115 08 1070	Pean svorka preparační zahnutá; 14,4 cm	Pean dissecting forceps; 14,4 cm	122
115 08 1080	Pean svorka preparační zahnutá; 14,2 cm	Pean dissecting forceps; 14,2 cm	122
115 08 1090	Kocher svorka na cévy jemná rovná; 14,2 cm	Kocher artery forceps fine straight; 14,2 cm	123
115 08 1100	Kocher svorka na cévy jemná zahnutá; 14,2 cm	Kocher artery forceps fine bent; 14,2 cm	123
115 08 1110	Kocher svorka na cévy jemná rovná; 15,2 cm	Kocher artery forceps fine straight; 15,2 cm	123
115 08 1120	Kocher svorka na cévy jemná zahnutá; 15,2 cm	Kocher artery forceps fine bent; 15,2 cm	123
115 08 1130	Pean svorka na cévy jemná rovná; 16 cm	Pean artery forceps fine straight; 16 cm	123
115 08 1140	Pean svorka na cévy jemná zahnutá; 16 cm	Pean artery forceps fine bent; 16 cm	123
115 08 1150	Pean svorka na cévy jemná rovná; 20 cm	Pean artery forceps fine straight; 20 cm	123

číslo – number	název	item	strana – page
115 08 1160	Peán svorka na cévy jemná zahnutá; 20 cm	Peán artery forceps fine bent; 20 cm	123
115 08 1170	Peán svorka na cévy jemná rovná; 14,5 cm	Peán artery forceps fine straight; 14,5 cm	123
115 08 1180	Peán svorka na cévy jemná zahnutá; 14,6 cm	Peán artery forceps fine bent; 14,6 cm	123
115 14 0010	Micro-bulldog svorka na cévy rovná; 2,6 cm	Micro-bulldog artery forceps; 2,6 cm	114
115 14 0020	Micro-bulldog svorka na cévy zahnutá; 2,4 cm	Micro-bulldog artery forceps; 2,4 cm	114
115 14 0150	Dieffenbach svorka na cévy rovná; 6,5 cm	Dieffenbach artery forceps; 6,5 cm	115
115 14 0160	Dieffenbach svorka na cévy zahnutá; 6,5 cm	Dieffenbach artery forceps; 6,5 cm	115
115 14 1150	Overholt svorka na lobektomii fig.1; 19,5 cm	Overholt lobectomy forceps fig.1; 19,5 cm	128
115 14 1160	Overholt svorka na lobektomii fig.2; 22,2 cm	Overholt lobectomy forceps fig.2; 22,2 cm	128
115 14 1170	Semb uvolňovač mírně zahnutý matovaný; 21,4 cm	Semb dissecting forceps; 21,4 cm	138
115 14 1180	Semb uvolňovač silně zahnutý matovaný; 25,0 cm	Semb dissecting forceps; 25,0 cm	138
115 14 1190	Semb uvolňovač silně zahnutý jemný matovaný; 25,0 cm	Semb dissecting forceps; 25,0 cm	138
115 14 1410	Svorka atraumatická fig.1; 22,0 cm	Artery forceps atraumatic jaws fig.1; 22,0 cm	152
115 14 1420	Svorka atraumatická fig.2; 22,0 cm	Artery forceps atraumatic jaws fig.2; 22,0 cm	152
115 14 1430	Svorka atraumatická fig.3; 23,5 cm	Artery forceps atraumatic jaws fig.3; 23,5 cm	152
115 14 1440	Svorka atraumatická fig.4; 20,5 cm	Artery forceps atraumatic jaws fig.4; 20,5 cm	152
115 14 1450	Svorka atraumatická fig.5; 20,5 cm	Artery forceps atraumatic jaws fig.5; 20,5 cm	152
115 14 1460	Svorka atraumatická fig.6; 22,0 cm	Artery forceps atraumatic jaws fig.6; 22,0 cm	153
115 14 1470	Svorka atraumatická fig.7; 22,0 cm	Artery forceps atraumatic jaws fig.7; 22,0 cm	153
115 14 1480	Svorka atraumatická fig.8; 22,4 cm	Artery forceps atraumatic jaws fig.8; 22,4 cm	153
115 14 1490	Svorka atraumatická fig.9; 23,0 cm	Artery forceps atraumatic jaws fig.9; 23,0 cm	153
115 14 1500	Svorka atraumatická fig.10; 24,5 cm	Artery forceps atraumatic jaws fig.10; 24,5 cm	153
115 14 1600	Sarot svorka na cévy zahnutá; 23,0 cm	Sarot artery forceps; 23,0 cm	133
115 19 0010	Svorka na střeva rovná; 20,0 cm	Intestinal forceps; 20,0 cm	145
115 19 0020	Svorka na střeva zahnutá; 20,0 cm	Intestinal forceps; 20,0 cm	145
115 19 0070	Svorka na střeva rovná; 24,0 cm	Intestinal forceps; 24,0 cm	145
115 19 0080	Svorka na střeva jemná zahnutá; 23,5 cm	Intestinal forceps; 23,5 cm	145
115 19 0300	Svorka na hemoroidy; 21,2 cm	Hemorrhoidal forceps; 21,2 cm	431
115 22 0080	Guyon svorka na ledviny typ 1; 24,5 cm	Guyon kidney pedicle clamp-forceps fig. 1; 24,5 cm	139
115 27 0070	Mikulicz svorka na pobřišnici; 18,0 cm	Mikulicz peritoneal clamp-forceps; 18,0 cm	146
115 91 0031	Dieffenbach svorka na cévy rovná; 3,5 cm	Dieffenbach bulldog clamps; 3,5 cm	115
115 91 0032	Dieffenbach svorka na cévy rovná; 5,0 cm	Dieffenbach bulldog clamps; 5,0 cm	115
115 91 0034	Dieffenbach svorka na cévy zahnutá; 3,5 cm	Dieffenbach bulldog clamps; 3,5 cm	115
115 91 0035	Dieffenbach svorka na cévy zahnutá; 3,5 cm	Dieffenbach bulldog clamps; 3,5 cm	115
115 91 0037	Svorka pro svorky bulldog; 23,0 cm	Setting forceps for bulldog clamps; 23,0 cm	115
115 91 0039	Johns-Hopkins svorka na cévy rovná; 5,0 cm	Johns-Hopkins bulldog clamp; 5,0 cm	115
115 91 0040	Johns-Hopkins svorka na cévy rovná; 6,5 cm	Johns-Hopkins bulldog clamp; 6,5 cm	115
115 91 0041	Johns-Hopkins svorka na cévy rovná; 7,5 cm	Johns-Hopkins bulldog clamp; 7,5 cm	115
115 91 0042	Johns-Hopkins svorka na cévy rovná; 9,0 cm	Johns-Hopkins bulldog clamp; 9,0 cm	115
115 91 0044	Johns-Hopkins svorka na cévy zahnutá; 5,0 cm	Johns-Hopkins bulldog clamp; 5,0 cm	115
115 91 0045	Johns-Hopkins svorka na cévy zahnutá; 6,5 cm	Johns-Hopkins bulldog clamp; 6,5 cm	115
115 91 0046	Johns-Hopkins svorka na cévy zahnutá; 7,5 cm	Johns-Hopkins bulldog clamp; 7,5 cm	115
115 91 0047	Johns-Hopkins svorka na cévy zahnutá; 9,0 cm	Johns-Hopkins bulldog clamp; 9,0 cm	115
115 91 0048	Chaput svorka na cévy; 3×2 zuby; 13,0 cm	Chaput artery forceps; 3×2 teeth; 13,0 cm	116
115 91 0049	Tuffier svorka na cévy; 5×4 zuby; 13,0 cm	Tuffier artery forceps; 5×4 teeth; 13,0 cm	116
115 91 0050	Martel svorka na chlopeň; 14,0 cm	Martel flap forceps; 14,0 cm	116
115 91 0051	Willet-Martel svorka na chlopeň; 19,0 cm	Willet-Martel scalp flap forceps; 19,0 cm	116
115 91 0052	Peán svorka na cévy rovná; 14,0 cm	Peán artery forceps; 14,0 cm	117
115 91 0053	Peán svorka na cévy rovná; 16,0 cm	Peán artery forceps; 16,0 cm	117
115 91 0068	Hartmann svorka rovná; 10,0 cm	Hartmann forceps; 10,0 cm	117
115 91 0069	Hartmann svorka zahnutá; 10,0 cm	Hartmann forceps; 10,0 cm	117
115 91 0073	Micro-Mosquito svorka na cévy rovná; 12,0 cm	Micro-Mosquito artery forceps; 12,0 cm	119
115 91 0075	Micro-Mosquito svorka na cévy zahnutá; 12,0 cm	Micro-Mosquito artery forceps; 12,0 cm	119
115 91 0077	Micro-Mosquito svorka rovná 1×2 zuby; 12,0 cm	Micro-Mosquito artery forceps; 12,0 cm	119
115 91 0079	Micro-Mosquito svorka zahnutá 1×2 zuby; 12,0 cm	Micro-Mosquito artery forceps; 12,0 cm	119
115 91 0080	Halsted-Mosquito svorka na cévy rovná; 12,5 cm	Halsted-Mosquito artery forceps straight; 12,5 cm	119
115 91 0082	Halsted-Mosquito svorka na cévy zahnutá; 12,5 cm	Halsted-Mosquito artery forceps curved; 12,5 cm	119
115 91 0084	Halsted-Mosquito svorka; 1×2 zuby rovná; 12,5 cm	Halsted-Mosquito artery forceps straight; 1×2 teeth; 12,5 cm	119
115 91 0086	Halsted-Mosquito svorka zahnutá; 1×2 zuby; 12,5 cm	Halsted-Mosquito artery forceps curved; 1×2 teeth; 12,5 cm	119
115 91 0097	Leriche svorka na cévy rovná; 15,0 cm	Leriche artery forceps; 15,0 cm	120
115 91 0098	Leriche svorka na cévy zahnutá; 15,0 cm	Leriche artery forceps; 15,0 cm	120
115 91 0099	Leriche svorka na cévy rovná; 1×2 zuby; 15,0 cm	Leriche artery forceps; 1×2 teeth; 15,0 cm	120
115 91 0100	Leriche svorka na cévy zahnutá; 1×2 zuby; 15,0 cm	Leriche artery forceps; 1×2 teeth; 15,0 cm	120
115 91 0101	Providence-Hospital svorka na cévy rovná; 14,0 cm	Providence-Hospital artery forceps; 14,0 cm	120
115 91 0102	Providence-Hospital svorka na cévy zahnutá; 14,0 cm	Providence-Hospital artery forceps; 14,0 cm	120
115 91 0103	Kelly svorka na cévy rovná; 14,0 cm	Kelly artery forceps; 14,0 cm	122
115 91 0105	Kelly-Rankin svorka na cévy rovná; 16,0 cm	Kelly-Rankin artery forceps; 16,0 cm	122
115 91 0106	Kelly-Rankin svorka na cévy zahnutá; 16,0 cm	Kelly-Rankin artery forceps; 16,0 cm	122
115 91 0111	Crile svorka na cévy rovná; 14,0 cm	Crile artery forceps; 14,0 cm	122
115 91 0112	Crile svorka na cévy zahnutá; 14,0 cm	Crile artery forceps; 14,0 cm	122
115 91 0113	Crile svorka na cévy rovná; 1×2 zuby; 14,0 cm	Crile artery forceps; 1×2 teeth; 14,0 cm	122

číslo – number	název	item	strana – page
115 91 0114	Crile svorka na cévy zahnutá; 1×2 zuby; 14,0 cm	Crile artery forceps; 1×2 teeth; 14,0 cm	122
115 91 0115	Crile-Rankin svorka na cévy rovná; 16,0 cm	Crile-Rankin artery forceps; 16,0 cm	122
115 91 0116	Crile-Rankin svorka na cévy zahnutá; 16,0 cm	Crile-Rankin artery forceps; 16,0 cm	122
115 91 0117	Rochester-Pean svorka na cévy rovná; 14,0 cm	Rochester-Pean artery forceps; 14,0 cm	124
115 91 0118	Rochester-Pean svorka na cévy rovná; 16,0 cm	Rochester-Pean artery forceps; 16,0 cm	124
115 91 0119	Rochester-Pean svorka na cévy rovná; 18,0 cm	Rochester-Pean artery forceps; 18,0 cm	124
115 91 0120	Rochester-Pean svorka na cévy rovná; 20,0 cm	Rochester-Pean artery forceps; 20,0 cm	124
115 91 0121	Rochester-Pean svorka na cévy rovná; 22,0 cm	Rochester-Pean artery forceps; 22,0 cm	124
115 91 0122	Rochester-Pean svorka na cévy rovná; 24,0 cm	Rochester-Pean artery forceps; 24,0 cm	124
115 91 0123	Rochester-Pean svorka na cévy rovná; 26,0 cm	Rochester-Pean artery forceps; 26,0 cm	124
115 91 0124	Rochester-Pean svorka na cévy rovná; 30,0 cm	Rochester-Pean artery forceps; 30,0 cm	124
115 91 0125	Rochester-Pean svorka na cévy zahnutá; 14,0 cm	Rochester-Pean artery forceps; 14,0 cm	125
115 91 0126	Rochester-Pean svorka na cévy zahnutá; 16,0 cm	Rochester-Pean artery forceps; 16,0 cm	125
115 91 0127	Rochester-Pean svorka na cévy zahnutá; 18,0 cm	Rochester-Pean artery forceps; 18,0 cm	125
115 91 0128	Rochester-Pean svorka na cévy zahnutá; 20,0 cm	Rochester-Pean artery forceps; 20,0 cm	125
115 91 0129	Rochester-Pean svorka na cévy zahnutá; 22,0 cm	Rochester-Pean artery forceps; 22,0 cm	125
115 91 0130	Rochester-Pean svorka na cévy zahnutá; 24,0 cm	Rochester-Pean artery forceps; 24,0 cm	125
115 91 0131	Rochester-Pean svorka na cévy zahnutá; 26,0 cm	Rochester-Pean artery forceps; 26,0 cm	125
115 91 0132	Rochester-Pean svorka na cévy zahnutá; 30,0 cm	Rochester-Pean artery forceps; 30,0 cm	125
115 91 0133	Ochsner-Kocher svorka na cévy rovná; 14,0 cm	Ochsner-Kocher artery forceps; 14,0 cm	126
115 91 0134	Ochsner-Kocher svorka na cévy rovná; 16,0 cm	Ochsner-Kocher artery forceps; 16,0 cm	126
115 91 0135	Ochsner-Kocher svorka na cévy rovná; 18,0 cm	Ochsner-Kocher artery forceps; 18,0 cm	126
115 91 0136	Ochsner-Kocher svorka na cévy rovná; 20,0 cm	Ochsner-Kocher artery forceps; 20,0 cm	126
115 91 0137	Ochsner-Kocher svorka na cévy rovná; 22,0 cm	Ochsner-Kocher artery forceps; 22,0 cm	126
115 91 0138	Ochsner-Kocher svorka na cévy rovná; 24,0 cm	Ochsner-Kocher artery forceps; 24,0 cm	126
115 91 0139	Ochsner-Kocher svorka na cévy rovná; 26,0 cm	Ochsner-Kocher artery forceps; 26,0 cm	126
115 91 0140	Ochsner-Kocher svorka na cévy rovná; 30,0 cm	Ochsner-Kocher artery forceps; 30,0 cm	126
115 91 0141	Ochsner-Kocher svorka na cévy zahnutá; 14,0 cm	Ochsner-Kocher artery forceps; 14,0 cm	127
115 91 0142	Ochsner-Kocher svorka na cévy zahnutá; 16,0 cm	Ochsner-Kocher artery forceps; 16,0 cm	127
115 91 0143	Ochsner-Kocher svorka na cévy zahnutá; 18,0 cm	Ochsner-Kocher artery forceps; 18,0 cm	127
115 91 0144	Ochsner-Kocher svorka na cévy zahnutá; 20,0 cm	Ochsner-Kocher artery forceps; 20,0 cm	127
115 91 0145	Ochsner-Kocher svorka na cévy zahnutá; 22,0 cm	Ochsner-Kocher artery forceps; 22,0 cm	127
115 91 0146	Ochsner-Kocher svorka na cévy zahnutá; 24,0 cm	Ochsner-Kocher artery forceps; 24,0 cm	127
115 91 0147	Ochsner-Kocher svorka na cévy zahnutá; 26,0 cm	Ochsner-Kocher artery forceps; 26,0 cm	127
115 91 0148	Ochsner-Kocher svorka na cévy zahnutá; 30,0 cm	Ochsner-Kocher artery forceps; 30,0 cm	127
115 91 0161	Overholt-Geissendoerfer svorka na cévy fig.1	Overholt-Geissendoerfer forceps fig.1	128
115 91 0162	Overholt-Geissendoerfer svorka na cévy fig.2	Overholt-Geissendoerfer forceps fig.2	128
115 91 0163	Overholt-Geissendoerfer svorka na cévy fig.3	Overholt-Geissendoerfer forceps fig.3	128
115 91 0164	Overholt-Geissendoerfer svorka na cévy fig.4	Overholt-Geissendoerfer forceps fig.4	128
115 91 0165	Overholt-Geissendoerfer svorka na cévy fig.5	Overholt-Geissendoerfer forceps fig.5	128
115 91 0166	Overholt-Geissendoerfer svorka na cévy fig.6	Overholt-Geissendoerfer forceps fig.6	128
115 91 0167	Overholt-Geissendoerfer svorka na cévy fig.7	Overholt-Geissendoerfer forceps fig.7	128
115 91 0168	Overholt-Geissendoerfer svorka na cévy fig.1	Overholt-Geissendoerfer forceps fig.1	128
115 91 0169	Overholt-Geissendoerfer svorka na cévy fig.2	Overholt-Geissendoerfer forceps fig.2	128
115 91 0170	Overholt-Geissendoerfer svorka na cévy fig.3	Overholt-Geissendoerfer forceps fig.3	128
115 91 0171	Overholt-Geissendoerfer svorka na cévy fig.4	Overholt-Geissendoerfer forceps fig.4	128
115 91 0172	Overholt-Geissendoerfer svorka na cévy fig.5	Overholt-Geissendoerfer forceps fig.5	128
115 91 0173	Overholt-Geissendoerfer svorka na cévy fig.6	Overholt-Geissendoerfer forceps fig.6	128
115 91 0174	Overholt-Geissendoerfer svorka na cévy fig.7	Overholt-Geissendoerfer forceps fig.7	128
115 91 0176	Overholt svorka na cévy s-prohnutá; 18,5 cm	Overholt artery forceps; 18,5 cm	129
115 91 0177	Overholt svorka na cévy s-prohnutá; 20,5 cm	Overholt artery forceps; 20,5 cm	129
115 91 0178	Overholt svorka na cévy s-prohnutá; 21,0 cm	Overholt artery forceps; 21,0 cm	129
115 91 0179	Overholt svorka na cévy s-prohnutá; 21,5 cm	Overholt artery forceps; 21,5 cm	129
115 91 0180	Baby-Adson svorka na cévy zahnutá; 14,0 cm	Baby-Adson artery forceps; 14,0 cm	130
115 91 0181	Baby-Adson svorka na cévy zahnutá; 18,0 cm	Baby-Adson artery forceps; 18,0 cm	130
115 91 0182	Adson svorka na cévy rovná; 18,5 cm	Adson artery forceps; 18,5 cm	130
115 91 0183	Adson svorka na cévy zahnutá; 18,5 cm	Adson artery forceps; 18,5 cm	130
115 91 0184	Adson svorka na cévy rovná; 1×2 zuby; 18,5 cm	Adson artery forceps; 1×2 teeth; 18,5 cm	130
115 91 0185	Adson svorka na cévy zahnutá; 1×2 zuby; 18,5 cm	Adson artery forceps; 1×2 teeth; 18,5 cm	130
115 91 0186	Meeker svorka na cévy zahnutá; 18,0 cm	Meeker artery forceps; 18,0 cm	130
115 91 0187	Meeker svorka na cévy zahnutá; 28,0 cm	Meeker artery forceps; 28,0 cm	130
115 91 0192	Schmidt-Sawtell svorka na cévy mírně zahnutá; 19,0 cm	Schmidt-Sawtell artery forceps; 19,0 cm	131
115 91 0193	Schmidt-Sawtell svorka na cévy silně zahnutá; 19,0 cm	Schmidt-Sawtell artery forceps; 19,0 cm	131
115 91 0196	Rochester-Carmal svorka na cévy rovná; 16,0 cm	Rochester-Carmalt artery forceps; 16,0 cm	131
115 91 0197	Rochester-Carmal svorka na cévy rovná; 20,0 cm	Rochester-Carmalt artery forceps; 20,0 cm	131
115 91 0198	Rochester-Carmal svorka na cévy zahnutá; 16,0 cm	Rochester-Carmalt artery forceps; 16,0 cm	131
115 91 0199	Rochester-Carmal svorka na cévy zahnutá; 20,0 cm	Rochester-Carmalt artery forceps; 20,0 cm	131
115 91 0200	Bainbridge svorka na cévy rovná; 15,0 cm	Bainbridge artery forceps; 15,0 cm	131
115 91 0201	Bainbridge svorka na cévy rovná; 18,5 cm	Bainbridge artery forceps; 18,5 cm	131
115 91 0202	Bainbridge svorka na cévy zahnutá; 15,0 cm	Bainbridge artery forceps; 15,0 cm	131
115 91 0203	Bainbridge svorka na cévy zahnutá; 18,5 cm	Bainbridge artery forceps; 18,5 cm	131

číslo – number	název	item	strana – page
115 91 0204	Bengolea svorka na cévy rovná; 20,0 cm	Bengolea artery forceps; 20,0 cm	132
115 91 0205	Bengolea svorka na cévy rovná; 26,0 cm	Bengolea artery forceps; 26,0 cm	132
115 91 0206	Bengolea svorka na cévy zahnutá; 20,0 cm	Bengolea artery forceps; 20,0 cm	132
115 91 0207	Bengolea svorka na cévy zahnutá; 26,0 cm	Bengolea artery forceps; 26,0 cm	132
115 91 0208	Bengolea svorka na cévy rovná; 1×2 zuby; 20,0 cm	Bengolea artery forceps; 1×2 teeth; 20,0 cm	132
115 91 0209	Bengolea svorka na cévy rovná; 1×2 zuby; 26,0 cm	Bengolea artery forceps; 1×2 teeth; 26,0 cm	132
115 91 0210	Bengolea svorka na cévy zahnutá; 1×2 zuby; 20,0 cm	Bengolea artery forceps; 1×2 teeth; 20,0 cm	132
115 91 0211	Bengolea svorka na cévy zahnutá; 1×2 zuby; 26,0 cm	Bengolea artery forceps; 1×2 teeth; 26,0 cm	132
115 91 0212	Crafoord-Sellors svorka bronchiální; 22,0 cm	Crafoord-Sellors bronchus forceps; 22,0 cm	132
115 91 0213	Crafoord-Sellors svorka bronchiální; 23,0 cm	Crafoord-Sellors bronchus forceps; 23,0 cm	132
115 91 0214	Crafoord-Sellors svorka bronchiální; 24,0 cm	Crafoord-Sellors bronchus forceps; 24,0 cm	132
115 91 0215	Overholt-Mixter svorka na cévy zahnutá; 21,0 cm	Overholt-Mixter artery forceps; 21,0 cm	132
115 91 0216	Heiss svorka na cévy rovná fig.1; 20,0 cm	Heiss artery forceps fig.1; 20,0 cm	133
115 91 0217	Heiss svorka na cévy mírně zahnutá; 20,0 cm	Heiss artery forceps; 20,0 cm	133
115 91 0218	Heiss svorka na cévy silně zahnutá; 20,0 cm	Heiss artery forceps; 20,0 cm	133
115 91 0219	Roberts svorka na cévy rovná; 22,0 cm	Roberts artery forceps; 22,0 cm	133
115 91 0220	Roberts svorka na cévy zahnutá; 22,0 cm	Roberts artery forceps; 22,0 cm	133
115 91 0221	Sarot svorka na cévy rovná; 24,0 cm	Sarot artery forceps; 24,0 cm	133
115 91 0223	Crafoord svorka na cévy zahnutá; 24,0 cm	Crafoord artery forceps; 24,0 cm	133
115 91 0224	Rumel svorka preparační fig.1; 23,0 cm	Rumel dissecting forceps fig.1; 23,0 cm	134
115 91 0225	Rumel svorka preparační fig.2; 23,0 cm	Rumel dissecting forceps fig.2; 23,0 cm	134
115 91 0226	Rumel svorka preparační fig.3; 23,0 cm	Rumel dissecting forceps fig.3; 23,0 cm	134
115 91 0227	Rumel svorka preparační fig.4; 23,0 cm	Rumel dissecting forceps fig.4; 23,0 cm	134
115 91 0229	Zenker svorka preparační mírně zahnutá; 29,5 cm	Zenker dissecting forceps; 29,5 cm	134
115 91 0230	Zenker svorka preparační silně zahnutá; 29,5 cm	Zenker dissecting forceps; 29,5 cm	134
115 91 0231	Mixter svorka preparační zahnutá; 15,5 cm	Mixter dissecting forceps; 15,5 cm	135
115 91 0232	Mixter svorka preparační zahnutá; 19,0 cm	Mixter dissecting forceps; 19,0 cm	135
115 91 0233	Mixter-O'Shaugnessy svorka preparační zahnutá; 15,5 cm	Mixter-O'Shaugnessy dissecting forceps; 15,5 cm	135
115 91 0234	Mixter-O'Shaugnessy svorka preparační zahnutá; 19,0 cm	Mixter-O'Shaugnessy dissecting forceps; 19,0 cm	135
115 91 0235	Baby-Mixter svorka preparační zahnutá; 18,0 cm	Baby-Mixter dissecting forceps; 18,0 cm	135
115 91 0236	Baby-Mixter svorka preparační zahnutá; 14,0 cm	Baby-Mixter dissecting forceps; 14,0 cm	135
115 91 0237	Baby-Mixter svorka preparační zahnutá; 14,0 cm	Baby-Mixter dissecting forceps; 14,0 cm	135
115 91 0238	Mixter svorka preparační fig.1; 22,0 cm	Mixter dissecting forceps fig.1; 22,0 cm	135
115 91 0239	Mixter svorka preparační fig.2; 25,0 cm	Mixter dissecting forceps fig.2; 25,0 cm	135
115 91 0240	Mixter svorka preparační fig.3; 28,0 cm	Mixter dissecting forceps fig.3; 28,0 cm	135
115 91 0242	Bridge svorka preparační rovná; 28,0 cm	Bridge dissecting forceps; 28,0 cm	136
115 91 0243	Bridge svorka preparační zahnutá; 28,0 cm	Bridge dissecting forceps; 28,0 cm	136
115 91 0244	Lawrence svorka preparační zahnutá; 28,0 cm	Lawrence dissecting forceps; 28,0 cm	136
115 91 0245	Kantrowitz svorka preparační zahnutá; 20,0 cm	Kantrowitz dissecting and ligature forceps; 20,0 cm	137
115 91 0246	Kantrowitz svorka preparační zahnutá; 24,0 cm	Kantrowitz dissecting and ligature forceps; 24,0 cm	137
115 91 0247	Kantrowitz svorka preparační zahnutá; 28,0 cm	Kantrowitz dissecting and ligature forceps; 28,0 cm	137
115 91 0249	Gemini svorka preparační zahnutá; 18,0 cm	Gemini dissecting and ligature forceps; 18,0 cm	137
115 91 0251	Gemini svorka preparační zahnutá; 25,0 cm	Gemini dissecting and ligature forceps; 25,0 cm	137
115 91 0252	Gemini svorka preparační zahnutá; 28,0 cm	Gemini dissecting and ligature forceps; 28,0 cm	137
115 91 0253	Toennis svorka preparační rovná; 21,0 cm	Toennis dissecting forceps; 21,0 cm	137
115 91 0254	Toennis svorka preparační rovná; 26,0 cm	Toennis dissecting forceps; 26,0 cm	137
115 91 0255	Toennis svorka preparační zahnutá; 21,0 cm	Toennis dissecting forceps; 21,0 cm	137
115 91 0256	Toennis svorka preparační zahnutá; 26,0 cm	Toennis dissecting forceps; 26,0 cm	137
115 91 0257	Toennis svorka preparační rovná; 1×2 zuby; 21,0 cm	Toennis dissecting forceps; 1×2 teeth; 21,0 cm	137
115 91 0258	Toennis svorka preparační rovná; 1×2 zuby; 26,0 cm	Toennis dissecting forceps; 1×2 teeth; 26,0 cm	137
115 91 0259	Toennis svorka preparační zahnutá; 1×2 zuby; 21,0 cm	Toennis dissecting forceps; 1×2 teeth; 21,0 cm	137
115 91 0260	Toennis svorka preparační zahnutá; 1×2 zuby; 26,0 cm	Toennis dissecting forceps; 1×2 teeth; 26,0 cm	137
115 91 0261	Lahey svorka na žlučovod; 19,0 cm	Lahey gall duct clamp; 19,0 cm	140
115 91 0262	Lahey svorka na žlučovod; 23,0 cm	Lahey gall duct clamp; 23,0 cm	140
115 91 0263	Lower svorka na ledviny zahnutá; 18,0 cm	Lower kidney pedicle forceps; 18,0 cm	140
115 91 0264	Finocchietto svorka na ledviny zahnutá; 24,0 cm	Finocchietto kidney pedicle forceps; 24,0 cm	140
115 91 0265	Guyon svorka na ledviny; 20,0 cm	Guyon kidney pedicle clamp-forceps; 20,0 cm	139
115 91 0266	Guyon svorka na ledviny; 22,0 cm	Guyon kidney pedicle clamp-forceps; 22,0 cm	139
115 91 0267	Guyon svorka na ledviny; 24,0 cm	Guyon kidney pedicle clamp-forceps; 24,0 cm	139
115 91 0268	Stille svorka na ledviny; 23,0 cm	Stille kidney pedicle clamp-forceps; 23,0 cm	139
115 91 0269	Guyon svorka na ledviny; 23,0 cm	Guyon kidney pedicle clamp-forceps; 23,0 cm	139
115 91 0270	Herrick svorka na ledviny; 23,0 cm	Herrick kidney pedicle clamp-forceps; 23,0 cm	139
115 91 0271	Gray svorka na žlučovod s-prohnutá; 22,0 cm	Gray gall duct clamp; 22,0 cm	141
115 91 0272	Gray svorka na žlučovod s-prohnutá; 23,0 cm	Gray gall duct clamp; 23,0 cm	141
115 91 0273	Gray svorka na žlučovod s-prohnutá; 1×2 zuby; 22,0 cm	Gray gall duct clamp; 1×2 teeth; 22,0 cm	141
115 91 0274	Gray svorka na žlučovod s-prohnutá; 1×2 zuby; 23,0 cm	Gray gall duct clamp; 1×2 teeth; 23,0 cm	141
115 91 0275	Desjardins svorka na žlučovod; 21,0 cm	Desjardins gall duct clamp; 21,0 cm	141
115 91 0276	Negus svorka na žlučovod fig.1; 19,0 cm	Negus gall duct clamp fig.1; 19,0 cm	141
115 91 0277	Negus svorka na žlučovod fig.2; 19,0 cm	Negus gall duct clamp fig.2; 19,0 cm	141
115 91 0281	Wertheim svorka na hysterektomii; 27,0 cm	Wertheim hysterectomy clamp-forceps; 27,0 cm	142
115 91 0282	Wertheim svorka na hysterektomii extra silná; 24,0 cm	Wertheim hysterectomy clamp-forceps; 24,0 cm	142

číslo – number	název	item	strana – page
115 91 0283	Wertheim svorka na hysterektomii; 25,0 cm	Wertheim hysterectomy clamp-forceps; 25,0 cm	142
115 91 0284	Wertheim svorka na hysterektomii mírně zah.; 1×2 zuby; 23,0 cm	Wertheim hysterectomy clamp-forceps; 1×2 teeth; 23,0 cm	143
115 91 0285	Wertheim svorka na hysterektomii silně zah.; 1×2 zuby; 23,0 cm	Wertheim hysterectomy clamp-forceps; 1×2 teeth; 23,0 cm	143
115 91 0286	Heaney svorka na hysterektomii; 21,0 cm	Heaney hysterectomy clamp-forceps; 21,0 cm	143
115 91 0287	Heaney svorka na hysterektomii; 1 zub; 21,0 cm	Heaney hysterectomy clamp-forceps; 1 tooth; 21,0 cm	143
115 91 0288	Heaney svorka na hysterektomii; 1 zub; 23,0 cm	Heaney hysterectomy clamp-forceps; 1 tooth; 23,0 cm	143
115 91 0289	Heaney svorka na hysterektomii; 2 zuby; 21,0 cm	Heaney hysterectomy clamp-forceps; 2 teeth; 21,0 cm	143
115 91 0290	Heaney svorka na hysterektomii; 2 zuby; 23,0 cm	Heaney hysterectomy clamp-forceps; 2 teeth; 23,0 cm	143
115 91 0291	Heaney-Ballantine svorka na hysterektomii rovná; 21,0 cm	Heaney-Ballantine clamp-forceps; 21,0 cm	144
115 91 0292	Heaney-Ballantine svorka na hysterektomii zahnutá; 21,0 cm	Heaney-Ballantine clamp-forceps; 21,0 cm	144
115 91 0299	Wertheim-Cullen svorka na hysterektomii; 21,5 cm	Wertheim-Cullen clamp-forceps; 21,5 cm	144
115 91 0300	Phaneuf svorka na hysterektomii rovná; 1×2 zuby; 21,5 cm	Phaneuf hysterectomy forceps; 1×2 teeth; 21,5 cm	144
115 91 0301	Phaneuf svorka na hysterektomii zahnutá; 1×2 zuby; 21,5 cm	Phaneuf hysterectomy forceps; 1×2 teeth; 21,5 cm	144
115 91 0305	Parametrium svorka rovná; 21,0 cm	Parametrium clamp; 21,0 cm	147
115 91 0306	Parametrium svorka zahnutá fig.1; 21,0 cm	Parametrium clamp fig.1; 21,0 cm	147
115 91 0307	Parametrium svorka zahnutá fig.2; 21,0 cm	Parametrium clamp fig.2; 21,0 cm	147
115 91 0308	Parametrium svorka zahnutá fig.3; 21,0 cm	Parametrium clamp fig.3; 21,0 cm	147
115 91 0309	Parametrium svorka rovná; 24,0 cm	Parametrium clamp; 24,0 cm	147
115 91 0310	Parametrium svorka zahnutá fig.1; 24,0 cm	Parametrium clamp fig.1; 24,0 cm	147
115 91 0311	Parametrium svorka zahnutá fig.2; 24,0 cm	Parametrium clamp fig.2; 24,0 cm	147
115 91 0312	Parametrium svorka zahnutá fig.3; 24,0 cm	Parametrium clamp fig.3; 24,0 cm	147
115 91 0313	Fergusson svorka rovná; 16,0 cm	Fergusson angiotribe clamp; 16,0 cm	148
115 91 0314	Fergusson svorka rovná; 20,0 cm	Fergusson angiotribe clamp; 20,0 cm	148
115 91 0315	Fergusson svorka zahnutá; 16,0 cm	Fergusson angiotribe clamp; 16,0 cm	148
115 91 0316	Fergusson svorka zahnutá; 20,0 cm	Fergusson angiotribe clamp; 20,0 cm	148
115 91 0317	Pratt svorka na hemeroidy; 15,0 cm	Pratt haemorrhoidal forceps; 15,0 cm	148
115 91 0322	Baby-Mikulicz svorka na pobřišnici; 14,0 cm	Baby-Mikulicz peritoneal clamp-forceps; 14,0 cm	146
115 91 0326	Mikulicz svorka na pobřišnici; 1×2 zuby; 20,0 cm	Mikulicz peritoneal clamp-forceps; 1×2 teeth; 20,0 cm	146
115 91 0329	Faure svorka na pobřišnici; 1×2 zuby; 20,0 cm	Faure peritoneal clamp-forceps; 1×2 teeth; 20,0 cm	146
115 91 0330	Faure svorka na pobřišnici; 1×2 zuby; 20,0 cm	Faure peritoneal clamp-forceps; 1×2 teeth; 20,0 cm	146
115 91 0332	Schaedel svorka na prádlo; 9,0 cm	Schaedel towel forceps; 9,0 cm	188
115 91 0333	Jones svorka na prádlo; 5,0 cm	Jones towel forceps; 5,0 cm	188
115 91 0334	Jones svorka na prádlo; 9,0 cm	Jones towel forceps; 9,0 cm	188
115 91 0335	Engl. Modell svorka na prádlo; 9,0 cm	Engl. Modell towel forceps; 9,0 cm	188
115 91 0336	Doyen svorka na prádlo; 18,0 cm	Doyen towel forceps; 18,0 cm	188
115 91 0337	Bernhard svorka na prádlo; 16,5 cm	Bernhard towel forceps; 16,5 cm	188
115 91 0338	Lane svorka na prádlo; 15,0 cm	Lane towel forceps; 15,0 cm	188
115 91 0339	Lane svorka na prádlo; 18,0 cm	Lane towel forceps; 18,0 cm	188
115 91 0340	Lane svorka na prádlo; 20,0 cm	Lane towel forceps; 20,0 cm	188
115 91 0341	Backhaus-Clip svorka na prádlo; 11,0 cm	Backhaus-Clip towel forceps; 11,0 cm	189
115 91 0343	Backhaus svorka na prádlo; 11,0 cm	Backhaus towel forceps; 11,0 cm	189
115 91 0345	Backhaus svorka na prádlo; 11,0 cm	Backhaus towel forceps; 11,0 cm	189
115 91 0348	Roeder svorka na prádlo; 13,0 cm	Roeder towel forceps; 13,0 cm	189
115 91 0349	Roeder svorka na prádlo; 15,0 cm	Roeder towel forceps; 15,0 cm	189
115 91 0350	Lorna svorka na prádlo; 10,0 cm	Lorna towel forceps; 10,0 cm	189
115 91 0351	Lorna svorka na prádlo; 13,0 cm	Lorna towel forceps; 13,0 cm	189
115 91 0352	Tohoku-Japan svorka na prádlo; 10,0 cm	Tohoku-Japan towel forceps; 10,0 cm	189
115 91 0353	Tohoku-Japan svorka na prádlo; 13,0 cm	Tohoku-Japan towel forceps; 13,0 cm	189
115 91 0354	Peers svorka na prádlo; 14,5 cm	Peers towel forceps; 14,5 cm	189
115 91 0355	Presbyterian svorka na trubice; 16,5 cm	Presbyterian tubing clamp; 16,5 cm	190
115 91 0356	Presbyterian svorka na trubice; 18,0 cm	Presbyterian tubing clamp; 18,0 cm	190
115 91 0357	Klinikum Berlin svorka na trubice; 14,5 cm	Klinikum Berlin tubing clamp; 14,5 cm	190
115 91 0358	Svorka na trubice; 15,5 cm	Tubing clamp; 15,5 cm	190
115 91 0359	Svorka na trubice; 18,0 cm	Tubing clamp; 18,0 cm	190
115 91 0360	Svorka na trubice; 20,0 cm	Tubing clamp; 20,0 cm	190
115 91 0361	Svorka na trubice s klipem; 15,5 cm	Tubing clamp with clip; 15,5 cm	190
115 91 0362	Svorka na trubice s klipem; 18,0 cm	Tubing clamp with clip; 18,0 cm	190
115 91 0363	Svorka na trubice s klipem; 20,0 cm	Tubing clamp with clip; 20,0 cm	190
115 91 0364	Allis svorka chirurgická; 4×5 zubů; 15,0 cm	Allis tissue forceps; 4×5 teeth; 15,0 cm	114
115 91 0365	Allis svorka chirurgická; 5×6 zubů; 15,0 cm	Allis tissue forceps; 5×6 teeth; 15,0 cm	114
115 91 0366	Allis svorka chirurgická; 5×6 zubů; 19,0 cm	Allis tissue forceps; 5×6 teeth; 19,0 cm	114
115 91 0367	Allis svorka chirurgická; 5×6 zubů; 25,0 cm	Allis tissue forceps; 5×6 teeth; 25,0 cm	114
115 91 0382	Babcock svorka chirurgická; 16,0 cm	Babcock tissue seizing forceps; 16,0 cm	114
115 91 0384	Babcock svorka chirurgická; 18,0 cm	Babcock tissue seizing forceps; 18,0 cm	114
115 91 0385	Babcock svorka chirurgická; 20,0 cm	Babcock tissue seizing forceps; 20,0 cm	114
115 91 0386	Babcock svorka chirurgická; 24,0 cm	Babcock tissue seizing forceps; 24,0 cm	114
115 91 0488	Satinsky svorka atraumatická; 24,0 cm	Satinsky atrauma forceps; 24,0 cm	164
115 91 0489	Leland-Jones svorka atraumatická; 20,0 cm	Leland-Jones atrauma forceps; 20,0 cm	158
115 91 0490	De Bakey svorka atraumatická; 20,0 cm	De Bakey atrauma forceps; 20,0 cm	157
115 91 0492	Satinsky svorka atraumatická; 20,5 cm	Satinsky atrauma forceps; 20,5 cm	164
115 91 0578	Kroužek "0" gumový	Gum O-ring for applicator	431

číslo – number	název	item	strana – page
115 91 0591	De Bakey-Pean svorka atraumatická; 14,0 cm	De Bakey-Pean atrauma forceps; 14,0 cm	155
115 91 0592	De Bakey-Pean svorka atraumatická; 14,0 cm	De Bakey-Pean atrauma forceps; 14,0 cm	155
115 91 0594	Cooley svorka atraumatická; 14,0 cm	Cooley atrauma forceps; 14,0 cm	181
115 91 0595	Cooley svorka atraumatická; 14,0 cm	Cooley atrauma forceps; 14,0 cm	181
115 91 0596	De Bakey-Mosquito svorka atraumatická; 12,0 cm	De Bakey-Mosquito atrauma forceps; 12,0 cm	154
115 91 0597	De Bakey-Pean svorka atraumatická; 20,0 cm	De Bakey-Pean atrauma forceps; 20,0 cm	155
115 91 0598	De Bakey svorka atraumatická; 21,0 cm	De Bakey atrauma forceps; 21,0 cm	163
115 91 0599	Lees svorka atraumatická; 23,0 cm	Lees atrauma forceps; 23,0 cm	168
115 91 0600	De Bakey bulldog svorka atraumatická rovná; 7,5 cm	De Bakey atrauma bulldog clamp; 7,5 cm	149
115 91 0601	De Bakey bulldog svorka atraumatická rovná; 8,5 cm	De Bakey atrauma bulldog clamp; 8,5 cm	149
115 91 0602	De Bakey bulldog svorka atraumatická rovná; 10,5 cm	De Bakey atrauma bulldog clamp; 10,5 cm	149
115 91 0603	De Bakey bulldog svorka atraumatická rovná; 12,0 cm	De Bakey atrauma bulldog clamp; 12,0 cm	149
115 91 0604	De Bakey bulldog svorka atraumatická zahnutá; 7,0 cm	De Bakey atrauma bulldog clamp; 7,0 cm	149
115 91 0605	De Bakey bulldog svorka atraumatická zahnutá; 8,0 cm	De Bakey atrauma bulldog clamp; 8,0 cm	149
115 91 0606	De Bakey bulldog svorka atraumatická zahnutá; 10,0 cm	De Bakey atrauma bulldog clamp; 10,0 cm	149
115 91 0607	De Bakey bulldog svorka atraumatická zahnutá; 11,5 cm	De Bakey atrauma bulldog clamp; 11,5 cm	149
115 91 0608	Santulli bulldog svorka atraumatická; 7,0 cm	Santulli atrauma bulldog clamp; 7,0 cm	149
115 91 0609	Glover svorka atraumatická rovná; 6,0 cm	Glover atrauma clamp; 6,0 cm	150
115 91 0610	Glover svorka atraumatická rovná; 7,0 cm	Glover atrauma clamp; 7,0 cm	150
115 91 0611	Glover svorka atraumatická rovná; 9,0 cm	Glover atrauma clamp; 9,0 cm	150
115 91 0612	Glover svorka atraumatická rovná; 11,0 cm	Glover atrauma clamp; 11,0 cm	150
115 91 0613	Glover svorka atraumatická zahnutá; 5,5 cm	Glover atrauma clamp; 5,5 cm	150
115 91 0614	Glover svorka atraumatická zahnutá; 6,5 cm	Glover atrauma clamp; 6,5 cm	150
115 91 0615	Glover svorka atraumatická zahnutá; 8,5 cm	Glover atrauma clamp; 8,5 cm	150
115 91 0616	Glover svorka atraumatická zahnutá; 10,5 cm	Glover atrauma clamp; 10,5 cm	150
115 91 0617	Glover svorka atraumatická; 5,0 cm	Glover atrauma clamp; 5,0 cm	150
115 91 0618	De Bakey-Satinsky bulldog svorka; 7,0 cm	De Bakey-Satinsky bulldog clamp; 7,0 cm	151
115 91 0619	De Bakey-Carotis bulldog svorka; 9,0 cm	De Bakey-Carotis bulldog clamp; 9,0 cm	151
115 91 0620	De Bakey-Satinsky bulldog svorka; 10,0 cm	De Bakey-Satinsky bulldog clamp; 10,0 cm	151
115 91 0621	Gregory-Soft bulldog svorka	Gregory-Soft bulldog clamp	151
115 91 0622	Gregory-Soft bulldog svorka	Gregory-Soft bulldog clamp	151
115 91 0623	Gregory-Soft bulldog svorka	Gregory-Soft bulldog clamp	151
115 91 0624	Gregory-Soft bulldog svorka	Gregory-Soft bulldog clamp	151
115 91 0625	De Bakey-Rankin svorka atraumatická; 16,0 cm	De Bakey-Rankin atrauma forceps; 16,0 cm	154
115 91 0626	De Bakey-Rankin svorka atraumatická; 16,0 cm	De Bakey-Rankin atrauma forceps; 16,0 cm	154
115 91 0627	De Bakey-Mosquito svorka atraumatická; 15,0 cm	De Bakey-Mosquito atrauma forceps; 15,0 cm	154
115 91 0628	De Bakey-Mosquito svorka atraumatická; 15,0 cm	De Bakey-Mosquito atrauma forceps; 15,0 cm	154
115 91 0629	De Bakey-Mosquito svorka atraumatická; 12,0 cm	De Bakey-Mosquito atrauma forceps; 12,0 cm	154
115 91 0630	De Bakey-Pean svorka atraumatická; 16,0 cm	De Bakey-Pean atrauma forceps; 16,0 cm	155
115 91 0631	De Bakey-Pean svorka atraumatická; 18,0 cm	De Bakey-Pean atrauma forceps; 18,0 cm	155
115 91 0632	De Bakey-Pean svorka atraumatická; 16,0 cm	De Bakey-Pean atrauma forceps; 16,0 cm	155
115 91 0633	De Bakey-Pean svorka atraumatická; 18,0 cm	De Bakey-Pean atrauma forceps; 18,0 cm	155
115 91 0634	De Bakey-Pean svorka atraumatická; 20,0 cm	De Bakey-Pean atrauma forceps; 20,0 cm	155
115 91 0635	Potts svorka atraumatická; 21,0 cm	Potts atrauma forceps; 21,0 cm	156
115 91 0636	Potts svorka atraumatická; 22,0 cm	Potts atrauma forceps; 22,0 cm	156
115 91 0637	Potts svorka atraumatická; 22,0 cm	Potts atrauma forceps; 22,0 cm	156
115 91 0638	Potts svorka atraumatická; 22,0 cm	Potts atrauma forceps; 22,0 cm	156
115 91 0639	Potts svorka atraumatická; 21,0 cm	Potts atrauma forceps; 21,0 cm	156
115 91 0640	Potts svorka atraumatická; 22,0 cm	Potts atrauma forceps; 22,0 cm	156
115 91 0641	Potts svorka atraumatická; 22,0 cm	Potts atrauma forceps; 22,0 cm	156
115 91 0642	Potts svorka atraumatická; 22,0 cm	Potts atrauma forceps; 22,0 cm	156
115 91 0643	De Bakey svorka atraumatická; 19,0 cm	De Bakey atrauma forceps; 19,0 cm	157
115 91 0644	De Bakey svorka atraumatická; 23,0 cm	De Bakey atrauma forceps; 23,0 cm	157
115 91 0645	De Bakey svorka atraumatická; 16,0 cm	De Bakey atrauma forceps; 16,0 cm	157
115 91 0646	De Bakey svorka atraumatická; 19,0 cm	De Bakey atrauma forceps; 19,0 cm	157
115 91 0647	De Bakey svorka atraumatická; 20,0 cm	De Bakey atrauma forceps; 20,0 cm	157
115 91 0648	Leland-Jones svorka atraumatická; 18,0 cm	Leland-Jones atrauma forceps; 18,0 cm	158
115 91 0649	Leland-Jones svorka atraumatická; 19,0 cm	Leland-Jones atrauma forceps; 19,0 cm	158
115 91 0650	Bainbridge svorka atraumatická; 15,0 cm	Bainbridge atrauma forceps; 15,0 cm	158
115 91 0651	Bainbridge svorka atraumatická; 18,0 cm	Bainbridge atrauma forceps; 18,0 cm	158
115 91 0652	Bainbridge svorka atraumatická; 15,0 cm	Bainbridge atrauma forceps; 15,0 cm	158
115 91 0653	Bainbridge svorka atraumatická; 18,0 cm	Bainbridge atrauma forceps; 18,0 cm	158
115 91 0654	De Bakey svorka atraumatická; 26,0 cm	De Bakey atrauma forceps; 26,0 cm	159
115 91 0655	De Bakey svorka atraumatická; 27,0 cm	De Bakey atrauma forceps; 27,0 cm	159
115 91 0656	De Bakey svorka atraumatická; 31,0 cm	De Bakey atrauma forceps; 31,0 cm	159
115 91 0657	De Bakey svorka atraumatická; 33,0 cm	De Bakey atrauma forceps; 33,0 cm	159
115 91 0658	De Bakey svorka atraumatická; 25,0 cm	De Bakey atrauma forceps; 25,0 cm	160
115 91 0659	De Bakey svorka atraumatická; 26,0 cm	De Bakey atrauma forceps; 26,0 cm	160
115 91 0660	De Bakey svorka atraumatická; 24,0 cm	De Bakey atrauma forceps; 24,0 cm	160
115 91 0661	De Bakey svorka atraumatická; 24,0 cm	De Bakey atrauma forceps; 24,0 cm	160
115 91 0662	De Bakey svorka atraumatická; 30,0 cm	De Bakey atrauma forceps; 30,0 cm	161

číslo – number	název	item	strana – page
115 91 0663	De Bakey svorka atraumatická; 28,0 cm	De Bakey atrauma forceps; 28,0 cm	161
115 91 0664	De Bakey svorka atraumatická; 21,0 cm	De Bakey atrauma forceps; 21,0 cm	162
115 91 0665	De Bakey svorka atraumatická; 23,0 cm	De Bakey atrauma forceps; 23,0 cm	162
115 91 0666	De Bakey svorka atraumatická; 27,0 cm	De Bakey atrauma forceps; 27,0 cm	162
115 91 0667	De Bakey svorka atraumatická; 31,0 cm	De Bakey atrauma forceps; 31,0 cm	162
115 91 0668	De Bakey svorka atraumatická; 18,0 cm	De Bakey atrauma forceps; 18,0 cm	162
115 91 0669	De Bakey svorka atraumatická; 19,0 cm	De Bakey atrauma forceps; 19,0 cm	162
115 91 0670	De Bakey svorka atraumatická; 23,0 cm	De Bakey atrauma forceps; 23,0 cm	162
115 91 0671	De Bakey svorka atraumatická; 27,0 cm	De Bakey atrauma forceps; 27,0 cm	162
115 91 0672	De Bakey svorka atraumatická; 20,0 cm	De Bakey atrauma forceps; 20,0 cm	163
115 91 0673	De Bakey svorka atraumatická; 25,0 cm	De Bakey atrauma forceps; 25,0 cm	163
115 91 0674	De Bakey svorka atraumatická; 29,0 cm	De Bakey atrauma forceps; 29,0 cm	163
115 91 0675	De Bakey svorka atraumatická; 21,0 cm	De Bakey atrauma forceps; 21,0 cm	163
115 91 0676	De Bakey svorka atraumatická; 23,0 cm	De Bakey atrauma forceps; 23,0 cm	163
115 91 0677	De Bakey svorka atraumatická; 27,0 cm	De Bakey atrauma forceps; 27,0 cm	163
115 91 0678	De Bakey svorka atraumatická; 31,0 cm	De Bakey atrauma forceps; 31,0 cm	163
115 91 0679	Satinsky svorka atraumatická; 25,0 cm	Satinsky atrauma forceps; 25,0 cm	164
115 91 0680	Satinsky svorka atraumatická; 26,0 cm	Satinsky atrauma forceps; 26,0 cm	164
115 91 0681	Satinsky svorka atraumatická; 27,5 cm	Satinsky atrauma forceps; 27,5 cm	164
115 91 0682	Lambert-Kay svorka atraumatická; 21,0 cm	Lambert-Kay atrauma forceps; 21,0 cm	165
115 91 0683	Lambert-Kay svorka atraumatická; 21,0 cm	Lambert-Kay atrauma forceps; 21,0 cm	165
115 91 0684	De Bakey svorka atraumatická; 17,0 cm	De Bakey atrauma forceps; 17,0 cm	165
115 91 0685	De Bakey-Bahnsen svorka atraumatická; 23,0 cm	De Bakey-Bahnsen atrauma forceps; 23,0 cm	165
115 91 0686	De Bakey-Bahnsen svorka atraumatická; 24,0 cm	De Bakey-Bahnsen atrauma forceps; 24,0 cm	165
115 91 0687	De Bakey-Bahnsen svorka atraumatická; 25,0 cm	De Bakey-Bahnsen atrauma forceps; 25,0 cm	165
115 91 0688	Harken svorka atraumatická; 24,0 cm	Harken atrauma forceps; 24,0 cm	166
115 91 0689	Harken svorka atraumatická; 24,0 cm	Harken atrauma forceps; 24,0 cm	166
115 91 0690	Harken svorka atraumatická; 24,0 cm	Harken atrauma forceps; 24,0 cm	166
115 91 0691	Harken svorka atraumatická; 24,0 cm	Harken atrauma forceps; 24,0 cm	166
115 91 0692	Weber svorka atraumatická; 26,0 cm	Weber atrauma forceps; 26,0 cm	167
115 91 0693	Weber svorka atraumatická; 26,0 cm	Weber atrauma forceps; 26,0 cm	167
115 91 0694	Lees svorka atraumatická; 25,0 cm	Lees atrauma forceps; 25,0 cm	168
115 91 0695	Lees svorka atraumatická; 25,0 cm	Lees atrauma forceps; 25,0 cm	168
115 91 0696	De Bakey svorka atraumatická; 27,0 cm	De Bakey atrauma forceps; 27,0 cm	169
115 91 0697	Morris-De Bakey svorka atraumatická; 18,0 cm	Morris-De Bakey atrauma forceps; 18,0 cm	170
115 91 0698	Morris-De Bakey svorka atraumatická; 20,0 cm	Morris-De Bakey atrauma forceps; 20,0 cm	170
115 91 0699	Morris-De Bakey svorka atraumatická; 23,0 cm	Morris-De Bakey atrauma forceps; 23,0 cm	170
115 91 0700	Morris-De Bakey svorka atraumatická; 25,0 cm	Morris-De Bakey atrauma forceps; 25,0 cm	170
115 91 0701	Ochsner svorka atraumatická; 23,5 cm	Ochsner atrauma forceps; 23,5 cm	171
115 91 0702	Dietrich svorka atraumatická; 21,0 cm	Dietrich atrauma forceps; 21,0 cm	171
115 91 0703	Gregory svorka atraumatická; 14,0 cm	Gregory atrauma forceps; 14,0 cm	171
115 91 0704	Gregory svorka atraumatická; 16,0 cm	Gregory atrauma forceps; 16,0 cm	171
115 91 0705	Gregory svorka atraumatická; 18,0 cm	Gregory atrauma forceps; 18,0 cm	171
115 91 0706	Dale svorka atraumatická; 17,0 cm	Dale atrauma forceps; 17,0 cm	172
115 91 0707	Dale svorka atraumatická; 18,0 cm	Dale atrauma forceps; 18,0 cm	172
115 91 0708	Dale svorka atraumatická; 19,0 cm	Dale atrauma forceps; 19,0 cm	172
115 91 0709	Dale svorka atraumatická; 18,5 cm	Dale atrauma forceps; 18,5 cm	172
115 91 0710	Derra svorka atraumatická; 16,0 cm	Derra atrauma forceps; 16,0 cm	172
115 91 0711	Derra svorka atraumatická; 17,0 cm	Derra atrauma forceps; 17,0 cm	172
115 91 0712	Derra svorka atraumatická; 18,0 cm	Derra atrauma forceps; 18,0 cm	172
115 91 0713	Svorka atraumatická; 16,0 cm	Atrauma forceps; 16,0 cm	173
115 91 0714	Svorka atraumatická; 17,0 cm	Atrauma forceps; 17,0 cm	173
115 91 0715	Beck svorka atraumatická; 17,0 cm	Beck atrauma forceps; 17,0 cm	173
115 91 0716	Glover svorka atraumatická; 17,0 cm	Glover atrauma forceps; 17,0 cm	173
115 91 0717	Glover svorka atraumatická; 17,0 cm	Glover atrauma forceps; 17,0 cm	173
115 91 0718	De Bakey svorka atraumatická; 17,0 cm	De Bakey atrauma forceps; 17,0 cm	174
115 91 0719	De Bakey svorka atraumatická; 17,0 cm	De Bakey atrauma forceps; 17,0 cm	174
115 91 0720	De Bakey svorka atraumatická; 15,0 cm	De Bakey atrauma forceps; 15,0 cm	174
115 91 0721	De Bakey svorka atraumatická; 15,0 cm	De Bakey atrauma forceps; 15,0 cm	174
115 91 0722	De Bakey svorka atraumatická; 16,0 cm	De Bakey atrauma forceps; 16,0 cm	174
115 91 0723	Javid svorka atraumatická; 18,0 cm	Javid atrauma forceps; 18,0 cm	175
115 91 0724	Javid svorka atraumatická; 19,0 cm	Javid atrauma forceps; 19,0 cm	175
115 91 0725	Cooley svorka atraumatická; 16,0 cm	Cooley atrauma forceps; 16,0 cm	175
115 91 0726	Cooley svorka atraumatická; 16,0 cm	Cooley atrauma forceps; 16,0 cm	175
115 91 0727	Cooley svorka atraumatická; 20,0 cm	Cooley atrauma forceps; 20,0 cm	175
115 91 0728	Cooley svorka atraumatická; 20,0 cm	Cooley atrauma forceps; 20,0 cm	175
115 91 0729	Cooley svorka atraumatická; 20,0 cm	Cooley atrauma forceps; 20,0 cm	175
115 91 0730	Cooley svorka atraumatická; 20,0 cm	Cooley atrauma forceps; 20,0 cm	175
115 91 0731	Cooley svorka atraumatická; 20,0 cm	Cooley atrauma forceps; 20,0 cm	176
115 91 0732	Cooley svorka atraumatická; 17,0 cm	Cooley atrauma forceps; 17,0 cm	176
115 91 0733	Cooley svorka atraumatická; 17,0 cm	Cooley atrauma forceps; 17,0 cm	176

číslo – number	název	item	strana – page
115 91 0734	Cooley svorka atraumatická; 17,0 cm	Cooley atrauma forceps; 17,0 cm	177
115 91 0735	Cooley svorka atraumatická; 17,0 cm	Cooley atrauma forceps; 17,0 cm	177
115 91 0736	Cooley svorka atraumatická; 17,0 cm	Cooley atrauma forceps; 17,0 cm	177
115 91 0737	Cooley svorka atraumatická; 15,0 cm	Cooley atrauma forceps; 15,0 cm	177
115 91 0738	Cooley svorka atraumatická; 16,0 cm	Cooley atrauma forceps; 16,0 cm	177
115 91 0739	Cooley svorka atraumatická; 16,0 cm	Cooley atrauma forceps; 16,0 cm	178
115 91 0740	Cooley svorka atraumatická; 17,0 cm	Cooley atrauma forceps; 17,0 cm	178
115 91 0741	Cooley svorka atraumatická; 17,0 cm	Cooley atrauma forceps; 17,0 cm	178
115 91 0742	Cooley svorka atraumatická; 16,0 cm	Cooley atrauma forceps; 16,0 cm	178
115 91 0743	Cooley-Derra svorka atraumatická; 16,0 cm	Cooley-Derra atrauma forceps; 16,0 cm	179
115 91 0744	Cooley-Derra svorka atraumatická; 17,0 cm	Cooley-Derra atrauma forceps; 17,0 cm	179
115 91 0745	Cooley-Derra svorka atraumatická; 18,0 cm	Cooley-Derra atrauma forceps; 18,0 cm	179
115 91 0746	Beck svorka atraumatická; 17,0 cm	Beck atrauma forceps; 17,0 cm	179
115 91 0747	Dardik svorka atraumatická; 90°; 13,0 cm	Dardik atrauma forceps; 90°; 13,0 cm	180
115 91 0748	Dardik svorka atraumatická; 45°; 14,5 cm	Dardik atrauma forceps; 45°; 14,5 cm	180
115 91 0749	Dardik svorka atraumatická; 30°; 15,0 cm	Dardik atrauma forceps; 30°; 15,0 cm	180
115 91 0750	Dardik svorka atraumatická; 15°; 15,0 cm	Dardik atrauma forceps; 15°; 15,0 cm	180
115 91 0751	Dardik svorka atraumatická; 15,0 cm	Dardik atrauma forceps; 15,0 cm	180
115 91 0752	Dardik svorka atraumatická; 90°; 13,5 cm	Dardik atrauma forceps; 90°; 13,5 cm	180
115 91 0753	Dardik svorka atraumatická; 45°; 16,0 cm	Dardik atrauma forceps; 45°; 16,0 cm	180
115 91 0754	Dardik svorka atraumatická; 30°; 17,0 cm	Dardik atrauma forceps; 30°; 17,0 cm	180
115 91 0755	Dardik svorka atraumatická; 15°; 17,0 cm	Dardik atrauma forceps; 15°; 17,0 cm	180
115 91 0756	Dardik svorka atraumatická; 15,0 cm	Dardik atrauma forceps; 15,0 cm	180
115 91 0757	Cooley svorka atraumatická; 14,0 cm	Cooley atrauma forceps; 14,0 cm	181
115 91 0758	Cooley svorka atraumatická; 14,0 cm	Cooley atrauma forceps; 14,0 cm	181
115 91 0759	Cooley svorka atraumatická; 14,0 cm	Cooley atrauma forceps; 14,0 cm	181
115 91 0760	Svorka atraumatická; 14,0 cm	Atrauma forceps; 14,0 cm	182
115 91 0761	Svorka atraumatická; 14,0 cm	Atrauma forceps; 14,0 cm	182
115 91 0762	Svorka atraumatická; 14,0 cm	Atrauma forceps; 14,0 cm	182
115 91 0763	Svorka atraumatická; 13,0 cm	Atrauma forceps; 13,0 cm	182
115 91 0764	Svorka atraumatická; 14,0 cm	Atrauma forceps; 14,0 cm	182
115 91 0765	Svorka atraumatická; 13,0 cm	Atrauma forceps; 13,0 cm	182
115 91 0766	Svorka atraumatická; 13,0 cm	Atrauma forceps; 13,0 cm	182
115 91 0767	Svorka atraumatická; 14,0 cm	Atrauma forceps; 14,0 cm	182
115 91 0768	Svorka atraumatická; 13,5 cm	Atrauma forceps; 13,5 cm	182
115 91 0769	Svorka atraumatická; 16,5 cm	Atrauma forceps; 16,5 cm	183
115 91 0770	Svorka atraumatická; 16,0 cm	Atrauma forceps; 16,0 cm	183
115 91 0771	Svorka atraumatická; 15,0 cm	Atrauma forceps; 15,0 cm	183
115 91 0772	Svorka atraumatická; 15,0 cm	Atrauma forceps; 15,0 cm	183
115 91 0773	Svorka atraumatická; 15,5 cm	Atrauma forceps; 15,5 cm	183
115 91 0774	Svorka atraumatická; 13,0 cm	Atrauma forceps; 13,0 cm	184
115 91 0775	Svorka atraumatická; 13,0 cm	Atrauma forceps; 13,0 cm	184
115 91 0776	Svorka atraumatická; 11,0 cm	Atrauma forceps; 11,0 cm	184
115 91 0777	Svorka atraumatická; 12,0 cm	Atrauma forceps; 12,0 cm	184
115 91 0778	Svorka atraumatická; 12,0 cm	Atrauma forceps; 12,0 cm	184
115 91 0779	Svorka atraumatická; 12,0 cm	Atrauma forceps; 12,0 cm	184
115 91 0780	Svorka atraumatická; 12,0 cm	Atrauma forceps; 12,0 cm	184
115 91 0781	De Bakey svorka atraumatická; 12,0 cm	De Bakey atrauma forceps; 12,0 cm	185
115 91 0782	De Bakey svorka atraumatická; 13,0 cm	De Bakey atrauma forceps; 13,0 cm	185
115 91 0783	De Bakey svorka atraumatická; 10,0 cm	De Bakey atrauma forceps; 10,0 cm	185
115 91 0784	De Bakey svorka atraumatická; 11,0 cm	De Bakey atrauma forceps; 11,0 cm	185
115 91 0785	De Bakey svorka atraumatická; 12,0 cm	De Bakey atrauma forceps; 12,0 cm	185
115 91 0786	Subramanian-miniature svorka atraumatická	Subramanian-miniature atrauma forceps	186
115 91 0787	Subramanian svorka atraumatická; 16,0 cm	Subramanian atrauma forceps; 16,0 cm	186
115 91 0788	Subramanian svorka atraumatická; 16,0 cm	Subramanian atrauma forceps; 16,0 cm	186
115 91 0796	Satinsky svorka cévní; 26,0 cm	Satinsky vena-ceva forceps; 26,0 cm	187
115 91 0797	Satinsky svorka cévní; 26,0 cm	Satinsky vena-ceva forceps; 26,0 cm	187
115 91 0798	Baby-Satinsky svorka cévní; 15,0 cm	Baby-Ssatinsky vena-ceva forceps; 15,0 cm	187
115 91 0799	Harken svorka na cévy; 24,0 cm	Harken vena-ceva forceps; 24,0 cm	187
115 91 0800	Harken svorka na cévy; 24,0 cm	Harken vena-ceva forceps; 24,0 cm	187
115 91 0801	Harken svorka na cévy; 24,0 cm	Harken vena-ceva forceps; 24,0 cm	187
115 99 0074	Uvolňovač zahnutý; 22,8 cm	Dissecting forceps curved; 22,8 cm	138
116	KLEŠTĚ ŠTÍPACÍ	BONE RONGUEURS	
116 08 0030	Luer kleště štípací na kosti rovné; 17,0 cm	Luer bone rongeurs; 17,0 cm	196
116 08 0040	Luer kleště štípací na kosti slabě zahnuté; 17,0 cm	Luer bone rongeurs; 17,0 cm	196
116 08 0070	Luer kleště štípací na kosti silně zahnuté; 15,0 cm	Luer bone rongeurs; 15,0 cm	196
116 08 0080	Luer kleště štípací na kosti zahnuté; 14,5 cm	Luer bone rongeurs; 14,5 cm	196
116 08 0090	Ruskin kleště štípací na kosti zahnuté; 20,0 cm	Ruskin bone rongeurs; 20,0 cm	196
116 08 0130	Luer kleště štípací na kosti lomené; 23,5 cm	Luer bone rongeurs; 23,5 cm	196
116 08 0140	Luer kleště štípací na kosti zahnuté; 27,5 cm	Luer bone rongeurs; 27,5 cm	197
116 08 0150	Luer kleště štípací na kosti mírně lomené; 24,5 cm	Luer bone rongeurs; 24,5 cm	197

číslo – number	název	item	strana – page
116 08 0160	Luer kleště štípací na kosti lomené; 23,5 cm	Luer bone rongeurs; 23,5 cm	197
116 08 0180	Luer kleště štípací na kosti rovné; 21,5 cm	Luer bone rongeurs; 21,5 cm	197
116 08 0190	Luer-Stille kleště štípací na kosti zahnuté; 21,5 cm	Luer-Stille bone rongeurs; 21,5 cm	197
116 08 0280	Liston kleště štípací na kosti rovné; 14,0 cm	Liston bone rongeurs; 14,0 cm	201
116 08 0410	Liston kleště štípací na kosti rovné; 14,0 cm	Liston bone rongeurs; 14,0 cm	201
116 08 0440	Liston kleště štípací na kosti rovné; 19,0 cm	Liston bone rongeurs; 19,0 cm	201
116 08 0450	Liston kleště štípací na kosti zahnuté; 19,0 cm	Liston bone rongeurs; 19,0 cm	201
116 08 0470	Liston kleště štípací na kosti dvojité zahnuté; 25,0 cm	Liston bone rongeurs; 25,0 cm	202
116 11 0570	Kleště ARTRO 22° nahoru; 5,5×3,5 mm	Arthro forceps 22° up; 5,5×3,5 mm	206
116 11 0575	Kleště ARTRO 22° nahoru; 5,5×3,5 mm; 20° nahoru	Arthro forceps 22° up; 5,5×3,5 mm; 20° up	206
116 11 0580	Kleště ARTRO 22° nahoru; 5,5×3,5 mm; čelist vpravo	Arthro forceps 22° up; 5,5×3,5 mm; right-bent	206
116 11 0590	Kleště ARTRO 22° nahoru; 5,5×3,5 mm; čelist vlevo	Arthro forceps 22° up; 5,5×3,5 mm; left-bent	206
116 11 0600	Kleště ARTRO rovné; 5,5×1 mm	Arthro forceps straight; 5,5×1 mm	207
116 11 0620	Kleště ARTRO 16° nahoru; 4,5×3,5 mm	Arthro forceps 16° up; 4,5×3,5 mm	206
116 11 0630	Kleště ARTRO 15° nahoru; 5×3,5 mm; šikmé levé	Arthro forceps 15° up; 5×3,5 mm; slant left	206
116 11 0640	Kleště ARTRO 15° nahoru; 5×3,5 mm; šikmé pravé	Arthro forceps 15° up; 5×3,5 mm; slant right	206
116 11 0650	Kleště ARTRO rovné; 4×2,2 mm; miskové	Arthro forceps straight; 4×2,2 mm; bowl-shaped	207
116 11 0660	Kleště ARTRO rovné; 6 mm; úchopné	Arthro forceps straight; 6 mm; grasping	208
116 11 0670	Kleště ARTRO rovné; 5,5×3,5 mm	Arthro forceps straight; 5,5×3,5 mm	206
116 11 0675	Kleště ARTRO rovné; 5,5×3,5 mm; 20° nahoru	Arthro forceps straight; 5,5×3,5 mm; 20° up	206
116 11 0680	Kleště ARTRO rovné; 5,5×4,5 mm; čelist vpravo	Arthro forceps straight; 5,5×4,5 mm; right-bent	206
116 11 0690	Kleště ARTRO rovné; 5,5×3,5 mm; čelist vlevo	Arthro forceps straight; 5,5×3,5 mm; left-bent	206
116 11 0700	Kleště ARTRO rovné; 6,3×4,5 mm; oválné	Arthro forceps straight; 6,3×4,5 mm; oval	207
116 11 0710	Kleště ARTRO 22° nahoru; 6,3×4,5 mm; oválné	Arthro forceps 22° up; 6,3×4,5 mm; oval	207
116 11 0750	Kleště ARTRO rovné úzké; 5×1,3 mm	Arthro forceps straight narrow; 5×1,3 mm	207
116 11 0755	Kleště ARTRO rovné úzké; 5×1,3 mm; 20° nahoru	Arthro forceps straight narrow; 5×1,3 mm; 20° up	207
116 11 0760	Kleště ARTRO rovné úzké; 5×1,3 mm; čelist vpravo	Arthro forceps straight narrow; 5×1,3 mm; right-bent	207
116 11 0770	Kleště ARTRO rovné úzké; 5×1,3 mm; čelist vlevo	Arthro forceps straight narrow; 5×1,3 mm; left-bent	207
116 11 0780	Kleště ARTRO 22° nahoru; 5×1,3 mm	Arthro forceps 22° up narrow; 5×1,3 mm	207
116 11 0785	Kleště ARTRO 22° nahoru; 5×1,3 mm; 20° nahoru	Arthro forceps 22° up narrow; 5×1,3 mm; 20° up	207
116 11 0790	Kleště ARTRO 22° nahoru; 5×1,3 mm; čelist vpravo	Arthro forceps 22° up narrow; 5×1,3 mm; right-bent	207
116 11 0800	Kleště ARTRO 22° nahoru; 5×1,3 mm; čelist vlevo	Arthro forceps 22° up narrow; 5×1,3 mm; left-bent	207
116 11 0810	Kleště ARTRO rovné; 7,5×5,5 mm; 90° vlevo	Arthro forceps straight; 7,5×5,5 mm; 90° left	206
116 11 0820	Kleště ARTRO rovné; 7,5×5,5 mm; 90° vpravo	Arthro forceps straight; 7,5×5,5 mm; 90° right	206
116 11 0830	Kleště ARTRO rovné; 3,5×2,7 mm; miskové	Arthro forceps straight; 3,5×2,7 mm; bowl-shaped	207
116 11 0840	Kleště ARTRO rovné; 3 mm; úchopné Pean	Arthro forceps straight; 3 mm; grasping Pean	208
116 11 0850	Kleště ARTRO rovné; 2,5 mm; úchopné Kocher	Arthro forceps straight; 2,5 mm; grasping Kocher	208
116 11 0860	Kleště ARTRO rovné; 3 mm; propichovací	Arthro forceps straight; 3 mm; piercing	208
116 11 0870	Kleště ARTRO 30° nahoru; 3 mm; propichovací	Arthro forceps 30° up; 3 mm; piercing	208
116 11 0900	Kleště ARTRO rovné; 3,5×2,5 mm; šicí	Arthro forceps straight; 3,5×2,5 mm; suturing	208
116 11 0920	Kleště ARTRO rovné; 04,5×03,7 mm; sací	Arthro forceps straight; 04,5×03,7 mm; suction	208
116 11 0950	Kleště ARTRO 20° vlevo; 3×1,3 mm; nůžky	Arthro forceps 20° left curved; 3×1,3 mm; scissors	207
116 11 0960	Kleště ARTRO 20° vpravo; 3×1,3 mm; nůžky	Arthro forceps 20° right curved; 3×1,3 mm; scissors	207
116 11 1000	Kleště ARTRO rovné; 1,5 mm; extraktor stehů	Arthro forceps straight; 1,5 mm; suture extractor	208
116 17 0330	Zielke štípací meziobratlový; 20,0 cm	Zielke laminectomy rongeurs; 20,0 cm	210
116 17 0340	Zielke štípací meziobratlový vyhnutý vlevo; 20,0 cm	Zielke bone rongeurs; 20,0 cm	210
116 17 0350	Zielke štípací meziobratlový vyhnutý vpravo; 20,0 cm	Zielke bone rongeurs; 20,0 cm	210
116 17 0360	Kleště na meziobratlové ploténky; 12×2 mm; 14,0 cm	Laminectomy rongeurs; 12×2 mm; 14,0 cm	211
116 17 0380	Kleště na meziobratlové ploténky; 12×3 mm; 14,0 cm	Laminectomy rongeurs; 12×3 mm; 14,0 cm	211
116 17 0390	Kleště na meziobratlové ploténky; 12×4 mm; 14,0 cm	Laminectomy rongeurs; 12×4 mm; 14,0 cm	211
116 17 0400	Kleště na meziobratlové ploténky; 12×5 mm; 14,0 cm	Laminectomy rongeurs; 12×5 mm; 14,0 cm	211
116 17 0410	Kleště na meziobratlové ploténky; 12×6 mm; 14,0 cm	Laminectomy rongeurs; 12×6 mm; 14,0 cm	211
116 17 0440	Kleště na meziobr. plot.; 30° zah. nahoru; 12×2 mm; 14,0 cm	Laminectomy rongeurs; 30° up curved; 12×2 mm; 14,0 cm	211
116 17 0460	Kleště na meziobr. plot.; 30° zah. nahoru; 12×3 mm; 14,0 cm	Laminectomy rongeurs; 30° up curved; 12×3 mm; 14,0 cm	211
116 17 0470	Kleště na meziobr. plot.; 30° zah. nahoru; 12×4 mm; 14,0 cm	Laminectomy rongeurs; 30° up curved; 12×4 mm; 14,0 cm	211
116 17 0480	Kleště na meziobr. plot.; 30° zah. nahoru; 12×5 mm; 14,0 cm	Laminectomy rongeurs; 30° up curved; 12×5 mm; 14,0 cm	211
116 17 0490	Kleště na meziobr. plot.; 30° zah. nahoru; 12×6 mm; 14,0 cm	Laminectomy rongeurs; 30° up curved; 12×6 mm; 14,0 cm	211
116 17 0520	Kleště na meziobr. plot.; 30° zah. dolů; 12×2 mm; 14,0 cm	Laminectomy rongeurs; 30° down curved; 12×2 mm; 14,0 cm	211
116 17 0540	Kleště na meziobr. plot.; 30° zah. dolů; 12×3 mm; 14,0 cm	Laminectomy rongeurs; 30° down curved; 12×3 mm; 14,0 cm	211
116 17 0550	Kleště na meziobr. plot.; 30° zah. dolů; 12×4 mm; 14,0 cm	Laminectomy rongeurs; 30° down curved; 12×4 mm; 14,0 cm	211
116 17 0560	Kleště na meziobr. plot.; 30° zah. dolů; 12×5 mm; 14,0 cm	Laminectomy rongeurs; 30° down curved; 12×5 mm; 14,0 cm	211
116 17 0570	Kleště na meziobr. plot.; 30° zah. dolů; 12×6 mm; 14,0 cm	Laminectomy rongeurs; 30° down curved; 12×6 mm; 14,0 cm	211
116 17 0600	Kleště na meziobr. plot. rovné; 12×2 mm; 16,0 cm	Laminectomy rongeurs; 12×2 mm; 16,0 cm	213
116 17 0620	Kleště na meziobr. plot. rovné; 12×3 mm; 16,0 cm	Laminectomy rongeurs; 12×3 mm; 16,0 cm	213
116 17 0630	Kleště na meziobr. plot. rovné; 13×4 mm; 16,0 cm	Laminectomy rongeurs; 13×4 mm; 16,0 cm	213
116 17 0640	Kleště na meziobr. plot. rovné; 13×5 mm; 16,0 cm	Laminectomy rongeurs; 13×5 mm; 16,0 cm	213
116 17 0650	Kleště na meziobr. plot. rovné; 13×6 mm; 16,0 cm	Laminectomy rongeurs; 13×6 mm; 16,0 cm	213
116 17 0680	Kleště na meziobr. plot.; 30° zah. nahoru; 12×2 mm; 16,0 cm	Laminectomy rongeurs; 30° up curved; 12×2 mm; 16,0 cm	213
116 17 0700	Kleště na meziobr. plot.; 30° zah. nahoru; 12×3 mm; 16,0 cm	Laminectomy rongeurs; 30° up curved; 12×3 mm; 16,0 cm	213
116 17 0710	Kleště na meziobr. plot.; 30° zah. nahoru; 13×4 mm; 16,0 cm	Laminectomy rongeurs; 30° up curved; 13×4 mm; 16,0 cm	213
116 17 0720	Kleště na meziobr. plot.; 30° zah. nahoru; 13×5 mm; 16,0 cm	Laminectomy rongeurs; 30° up curved; 13×5 mm; 16,0 cm	213

číslo – number	název	item	strana – page
116 17 0730	Kleště na meziobr. plot.; 30° zah. nahoru; 13×6 mm; 16,0 cm	Laminectomy rongeurs; 30° up curved; 13×6 mm; 16,0 cm	213
116 17 0760	Kleště na meziobr. plot.; 30° zah. dolů; 12×2 mm; 16,0 cm	Laminectomy rongeurs; 30° down curved; 12×2 mm; 16,0 cm	213
116 17 0780	Kleště na meziobr. plot.; 30° zah. dolů; 12×3 mm; 16,0 cm	Laminectomy rongeurs; 30° down curved; 12×3 mm; 16,0 cm	213
116 17 0790	Kleště na meziobr. plot.; 30° zah. dolů; 12×4 mm; 16,0 cm	Laminectomy rongeurs; 30° down curved; 12×4 mm; 16,0 cm	213
116 17 0800	Kleště na meziobr. plot.; 30° zah. dolů; 12×5 mm; 16,0 cm	Laminectomy rongeurs; 30° down curved; 12×5 mm; 16,0 cm	213
116 17 0810	Kleště na meziobr. plot.; 30° zah. dolů; 13×6 mm; 16,0 cm	Laminectomy rongeurs; 30° down curved; 13×6 mm; 16,0 cm	213
116 17 0840	Kleště na meziobr. plot. rovné; 12×2 mm; 18,0 cm	Laminectomy rongeurs; 12×2 mm; 18,0 cm	212
116 17 0860	Kleště na meziobr. plot. rovné; 12×3 mm; 18,0 cm	Laminectomy rongeurs; 12×3 mm; 18,0 cm	212
116 17 0870	Kleště na meziobr. plot. rovné; 13×4 mm; 18,0 cm	Laminectomy rongeurs; 13×4 mm; 18,0 cm	212
116 17 0880	Kleště na meziobr. plot. rovné; 13×5 mm; 18,0 cm	Laminectomy rongeurs; 13×5 mm; 18,0 cm	212
116 17 0890	Kleště na meziobr. plot. rovné; 12×6 mm; 18,0 cm	Laminectomy rongeurs; 12×6 mm; 18,0 cm	212
116 17 0920	Kleště na meziobr. plot.; 30° zah. nahoru; 12×2 mm; 18,0 cm	Laminectomy rongeurs; 30° up curved; 12×2 mm; 18,0 cm	212
116 17 0940	Kleště na meziobr. plot.; 30° zah. nahoru; 12×3 mm; 18,0 cm	Laminectomy rongeurs; 30° up curved; 12×3 mm; 18,0 cm	212
116 17 0950	Kleště na meziobr. plot.; 30° zah. nahoru; 13×4 mm; 18,0 cm	Laminectomy rongeurs; 30° up curved; 13×4 mm; 18,0 cm	212
116 17 0960	Kleště na meziobr. plot.; 30° zah. nahoru; 13×5 mm; 18,0 cm	Laminectomy rongeurs; 30° up curved; 13×5 mm; 18,0 cm	212
116 17 0970	Kleště na meziobr. plot.; 30° zah. nahoru; 12×6 mm; 18,0 cm	Laminectomy rongeurs; 30° up curved; 12×6 mm; 18,0 cm	212
116 17 1000	Kleště na meziobr. plot.; 30° zah. dolů; 12×2 mm; 18,0 cm	Laminectomy rongeurs; 30° down curved; 12×2 mm; 18,0 cm	212
116 17 1020	Kleště na meziobr. plot.; 30° zah. dolů; 12×3 mm; 18,0 cm	Laminectomy rongeurs; 30° down curved; 12×3 mm; 18,0 cm	212
116 17 1030	Kleště na meziobr. plot.; 30° zah. dolů; 12×4 mm; 18,0 cm	Laminectomy rongeurs; 30° down curved; 12×4 mm; 18,0 cm	212
116 17 1040	Kleště na meziobr. plot.; 30° zah. dolů; 12×5 mm; 18,0 cm	Laminectomy rongeurs; 30° down curved; 12×5 mm; 18,0 cm	212
116 17 1050	Kleště na meziobr. plot.; 30° zah. dolů; 12×6 mm; 18,0 cm	Laminectomy rongeurs; 30° down curved; 12×6 mm; 18,0 cm	212
116 17 1110	Ferris-Smith-Kerrison štípací; 90°; 3,0 mm; 15,0 cm	Ferris-Smith-Kerrison laminectomy rongeurs; 90°; 3,0 mm; 15,0 cm	214
116 17 1120	Ferris-Smith-Kerrison štípací; 90°; 5,0 mm; 15,0 cm	Ferris-Smith-Kerrison laminectomy rongeurs; 90°; 5,0 mm; 15,0 cm	214
116 17 1170	Kerrison štípací na laminektomii; 40°; 3,0 mm; 15,0 cm	Kerrison laminectomy rongeurs; 40°; 3,0 mm; 15,0 cm	214
116 17 1180	Kerrison štípací na laminektomii; 40°; 5,0 mm; 15,0 cm	Kerrison laminectomy rongeurs; 40°; 5,0 mm; 15,0 cm	214
116 17 1210	Ferris-Smith-Kerrison štípací; 90°; 3,0 mm; 18,0 cm	Ferris-Smith-Kerrison laminectomy rongeurs; 90°; 3,0 mm; 18,0 cm	214
116 17 1220	Ferris-Smith-Kerrison štípací; 90°; 5,0 mm; 18,0 cm	Ferris-Smith-Kerrison laminectomy rongeurs; 90°; 5,0 mm; 18,0 cm	214
116 17 1270	Kerrison štípací na laminektomii; 40°; 3,0 mm; 18,0 cm	Kerrison laminectomy rongeurs; 40°; 3,0 mm; 18,0 cm	214
116 17 1280	Kerrison štípací na laminektomii; 40°; 5,0 mm; 18,0 cm	Kerrison laminectomy rongeurs; 40°; 5,0 mm; 18,0 cm	214
116 17 1310	Ferris-Smith-Kerrison štípací; 90°; 3,0 mm; 20,0 cm	Ferris-Smith-Kerrison laminectomy rongeurs; 90°; 3,0 mm; 20,0 cm	214
116 17 1320	Ferris-Smith-Kerrison štípací; 90°; 5,0 mm; 20,0 cm	Ferris-Smith-Kerrison laminectomy rongeurs; 90°; 5,0 mm; 20,0 cm	214
116 17 1370	Kerrison štípací na laminektomii; 40°; 3,0 mm; 20,0 cm	Kerrison laminectomy rongeurs; 40°; 3,0 mm; 20,0 cm	214
116 17 1380	Kerrison štípací na laminektomii; 40°; 5,0 mm; 20,0 cm	Kerrison laminectomy rongeurs; 40°; 5,0 mm; 20,0 cm	214
116 17 1400	Ferris-Smith-Kerrison štípací; 90°; 4,0 mm; 15,0 cm	Ferris-Smith-Kerrison laminectomy rongeurs; 90°; 4,0 mm; 15,0 cm	214
116 17 1410	Ferris-Smith-Kerrison štípací; 90°; 4,0 mm; 18,0 cm	Ferris-Smith-Kerrison laminectomy rongeurs; 90°; 4,0 mm; 18,0 cm	214
116 17 1420	Ferris-Smith-Kerrison štípací; 90°; 4,0 mm; 20,0 cm	Ferris-Smith-Kerrison laminectomy rongeurs; 90°; 4,0 mm; 20,0 cm	214
116 17 1460	Kerrison štípací na laminektomii; 40°; 4,0 mm; 15,0 cm	Kerrison laminectomy rongeurs; 40°; 4,0 mm; 15,0 cm	214
116 17 1470	Kerrison štípací na laminektomii; 40°; 4,0 mm; 18,0 cm	Kerrison laminectomy rongeurs; 40°; 4,0 mm; 18,0 cm	214
116 17 1480	Kerrison štípací na laminektomii; 40°; 4,0 mm; 20,0 cm	Kerrison laminectomy rongeurs; 40°; 4,0 mm; 20,0 cm	214
116 29 0010	Hartmann kleště na ušní polypy; 14,2 cm	Hartmann ear polypus forceps; 14,2 cm	216
116 29 0030	Hartmann kleště na ušní polypy; 14,2 cm	Hartmann ear polypus forceps; 14,2 cm	216
116 29 0120	Hartmann kleště na ušní polypy pod.; 2×10,5 mm; 10,0 cm	Hartmann ear polypus forceps; 2×10,5 mm; 10,0 cm	216
116 29 0170	Hartmann kleště na ušní polypy lžič.; 2,6 mm; 10,0 cm	Hartmann ear polypus forceps; 2,6 mm; 10,0 cm	216
116 29 0300	Strümpel kleště na ušní polypy; 2,2×7,0 mm	Strümpel ear polypus forceps; 2,2×7,0 mm	217
116 29 0400	Jansen kleště ušní štípací fig.1; 18,0 cm	Jansen mastoid forceps fig.1; 18,0 cm	217
116 29 0410	Jansen kleště ušní štípací fig.2; 18,0 cm	Jansen mastoid forceps fig.2; 18,0 cm	217
116 29 0740	Kleště štípací ostré horní; 1,7×2 mm; 7,0 cm	Mastoid forceps; 1,7×2 mm; 7,0 cm	218
116 29 0750	Kleště štípací ostré dolní; 1,7×2 mm; 7,0 cm	Mastoid forceps; 1,7×2 mm; 7,0 cm	218
116 29 0760	Kleště úchopné jemné; 0,6×0,9×3,5 mm; 7,0 cm	Grasping forceps; 0,6×0,9×3,5 mm; 7,0 cm	218
116 29 0770	Kleště úchopné jemné; 0,6×0,9×5,5 mm; 7,0 cm	Grasping forceps; 0,6×0,9×5,5 mm; 7,0 cm	218
116 91 0001	Kleště štípací na drát; 14,5 cm	Wire forceps; 14,5 cm	219
116 91 0004	Kleště štípací na drát; 18,0 cm	Wire cutting forceps; 18,0 cm	219
116 91 0005	Kleště štípací na drát; 17,0 cm	Wire cutting forceps; 17,0 cm	219
116 91 0006	Kleště štípací na drát; 22,0 cm	Wire cutting forceps; 22,0 cm	219
116 91 0007	Kleště štípací na drát; 47,0 cm	Wire cutting forceps; 47,0 cm	220
116 91 0008	Hercules kleště štípací na drát; 28,0 cm	Hercules wire cutting forceps; 28,0 cm	221
116 91 0009	Sada čelistí pro štípací kleště Hercules	Set of jaws for forceps Hercules	221
116 91 0010	Kleště štípací na drát; 21,5 cm	Wire cutting forceps; 21,5 cm	222
116 91 0011	Kleště štípací na drát; 23,0 cm	Wire cutting forceps; 23,0 cm	222
116 91 0013	Echlin kleště štípací; 2 mm; 23,0 cm	Echlin bone ronguers; 2 mm; 23,0 cm	199
116 91 0014	Echlin kleště štípací; 3 mm; 23,0 cm	Echlin bone ronguers; 3 mm; 23,0 cm	199
116 91 0015	Echlin kleště štípací; 4 mm; 23,0 cm	Echlin bone ronguers; 4 mm; 23,0 cm	199
116 91 0017	Mini-Friedman kleště štípací na kosti; 12,0 cm	Mini-Friedman bone ronguers; 12,0 cm	195
116 91 0140	Gluck kleště na žebra vytahovací; 22 cm	Gluck pulling forceps for ribs; 22 cm	204
116 91 0256	Giertz-Stille kleště na žebra; 27 cm	Giertz-Stille forceps for ribs; 27 cm	205
116 91 0258	Marquard kleště štípací; 20,0 cm	Marquard bone ronguers; 20,0 cm	198
116 91 0259	Mayfield kleště štípací na kosti; 17,0 cm	Mayfield bone ronguers; 17,0 cm	198
116 91 0260	Böhler kleště štípací na kosti; 15,0 cm	Böhler bone ronguers; 15,0 cm	198
116 91 0261	Böhler kleště štípací na kosti; 15,0 cm	Böhler bone ronguers; 15,0 cm	198
116 91 0262	Böhler kleště štípací na kosti; 15,0 cm	Böhler bone ronguers; 15,0 cm	198
116 91 0263	Kleinert-Kutz kleště štípací na kosti; 15,0 cm	Kleinert-Kutz bone ronguers; 15,0 cm	198

číslo – number	název	item	strana – page
116 91 0264	Kleinert-Kutz kleště štípací na kosti; 15,0 cm	Kleinert-Kutz bone ronguers; 15,0 cm	198
116 91 0266	Beyer kleště štípací na kosti; 18,0 cm	Beyar bone ronguers; 18,0 cm	198
116 91 0267	Zaufal-Jansen kleště štípací na kosti; 18,0 cm	Zaufal-Jansen bone ronguers; 18,0 cm	198
116 91 0271	Stille-Ruskin kleště štípací; 23,0 cm	Stille-Ruskin bone ronguers; 23,0 cm	199
116 91 0280	Ruskin kleště štípací; 23,0 cm	Ruskin bone ronguers; 23,0 cm	200
116 91 0281	Smith-Peterson kleště štípací; 3 mm; 24 cm	Smith-Peterson bone ronguers; 3 mm; 24 cm	200
116 91 0282	Smith-Peterson kleště štípací; 4 mm; 24 cm	Smith-Peterson bone ronguers; 4 mm; 24 cm	200
116 91 0283	Smith-Peterson kleště štípací; 5 mm; 24 cm	Smith-Peterson bone ronguers; 5 mm; 24 cm	200
116 91 0284	Smith-Peterson kleště štípací; 3 mm; 24 cm	Smith-Peterson bone ronguers; 3 mm; 24 cm	200
116 91 0285	Smith-Peterson kleště štípací; 4 mm; 24 cm	Smith-Peterson bone ronguers; 4 mm; 24 cm	200
116 91 0286	Smith-Peterson kleště štípací; 5 mm; 24 cm	Smith-Peterson bone ronguers; 5 mm; 24 cm	200
116 91 0287	Cottle Kazanjian kleště štípací; 19,0 cm	Cottle Kazanjian bone ronguers; 19,0 cm	202
116 91 0288	Cleveland-Gardner kleště štípací; 16,0 cm	Cleveland-Gardner bone ronguers; 16,0 cm	202
116 91 0289	Markwalder kleště štípací; 20,0 cm	Markwalder bone ronguers; 20,0 cm	202
116 91 0291	Liston kleště štípací; 17,0 cm	Liston bone ronguers; 17,0 cm	201
116 91 0293	Liston kleště štípací; 22,0 cm	Liston bone ronguers; 22,0 cm	201
116 91 0294	Liston kleště štípací; 14,0 cm	Liston bone ronguers; 14,0 cm	201
116 91 0295	Liston kleště štípací; 17,0 cm	Liston bone ronguers; 17,0 cm	201
116 91 0297	Liston kleště štípací; 22,0 cm	Liston bone ronguers; 22,0 cm	201
116 91 0298	Littauer-Liston kleště štípací; 15,0 cm	Littauer-Liston bone ronguers; 15,0 cm	203
116 91 0299	Cleveland kleště štípací; 15,0 cm	Cleveland bone ronguers; 15,0 cm	203
116 91 0300	Cleveland kleště štípací; 17,0 cm	Cleveland bone ronguers; 17,0 cm	203
116 91 0301	Kleště štípací; 12,0 cm	Bone ronguers; 12,0 cm	203
116 91 0305	Walton-Liston kleště štípací; 15,0 cm	Walton-Liston bone ronguers; 15,0 cm	203
116 91 0312	Kerrison štípací; 1 mm; 15,0 cm	Kerrison laminectomy punches; 1 mm; 15,0 cm	215
116 91 0313	Kerrison štípací; 2 mm; 15,0 cm	Kerrison laminectomy punches; 2 mm; 15,0 cm	215
116 91 0316	Kerrison štípací; 1 mm; 18,0 cm	Kerrison laminectomy punches; 1 mm; 18,0 cm	215
116 91 0317	Kerrison štípací; 2 mm; 18,0 cm	Kerrison laminectomy punches; 2 mm; 18,0 cm	215
116 91 0328	Kerrison štípací; 1 mm; 20,0 cm	Kerrison laminectomy punches; 1 mm; 20,0 cm	215
116 91 0329	Kerrison štípací; 2 mm; 20,0 cm	Kerrison laminectomy punches; 2 mm; 20,0 cm	215
116 91 0337	Kerrison štípací; 1 mm; 15,0 cm	Kerrison laminectomy punches; 1 mm; 15,0 cm	215
116 91 0338	Kerrison štípací; 2 mm; 15,0 cm	Kerrison laminectomy punches; 2 mm; 15,0 cm	215
116 91 0339	Kerrison štípací; 3 mm; 15,0 cm	Kerrison laminectomy punches; 3 mm; 15,0 cm	215
116 91 0340	Kerrison štípací; 5 mm; 15,0 cm	Kerrison laminectomy punches; 5 mm; 15,0 cm	215
116 91 0341	Kerrison štípací; 1 mm; 18,0 cm	Kerrison laminectomy punches; 1 mm; 18,0 cm	215
116 91 0342	Kerrison štípací; 2 mm; 18,0 cm	Kerrison laminectomy punches; 2 mm; 18,0 cm	215
116 91 0343	Kerrison štípací; 3 mm; 18,0 cm	Kerrison laminectomy punches; 3 mm; 18,0 cm	215
116 91 0344	Kerrison štípací; 5 mm; 18,0 cm	Kerrison laminectomy punches; 5 mm; 18,0 cm	215
116 91 0349	Kerrison štípací; 1 mm; 20,0 cm	Kerrison laminectomy punches; 1 mm; 20,0 cm	215
116 91 0350	Kerrison štípací; 2 mm; 20,0 cm	Kerrison laminectomy punches; 2 mm; 20,0 cm	215
116 91 0351	Kerrison štípací; 3 mm; 20,0 cm	Kerrison laminectomy punches; 3 mm; 20,0 cm	215
116 91 0352	Kerrison štípací; 5 mm; 20,0 cm	Kerrison laminectomy punches; 5 mm; 20,0 cm	215
116 91 0357	Kerrison štípací; 1 mm; 15,0 cm	Kerrison laminectomy punches; 1 mm; 15,0 cm	215
116 91 0358	Kerrison štípací; 2 mm; 15,0 cm	Kerrison laminectomy punches; 2 mm; 15,0 cm	215
116 91 0361	Kerrison štípací; 1 mm; 18,0 cm	Kerrison laminectomy punches; 1 mm; 18,0 cm	215
116 91 0362	Kerrison štípací; 2 mm; 18,0 cm	Kerrison laminectomy punches; 2 mm; 18,0 cm	215
116 91 0370	Kerrison štípací; 1 mm; 20,0 cm	Kerrison laminectomy punches; 1 mm; 20,0 cm	215
116 91 0371	Kerrison štípací; 2 mm; 20,0 cm	Kerrison laminectomy punches; 2 mm; 20,0 cm	215
116 91 0514	Friedman kleště štípací na kosti; 14,0 cm	Friedman bone ronguers; 14,0 cm	195
116 91 0515	Stellbrink kleště štípací na kosti; 17,0 cm	Stellbrink bone ronguers; 17,0 cm	195
116 91 0516	Stellbrink kleště štípací na kosti; 17,0 cm	Stellbrink bone ronguers; 17,0 cm	195
116 91 0518	Cleveland kleště štípací na kosti; 17,0 cm	Cleveland bone ronguers; 17,0 cm	195
116 91 0522	Blumenthal kleště štípací na kosti; 15,5 cm	Blumenthal bone ronguers; 15,5 cm	195
116 91 0523	Blumenthal kleště štípací na kosti; 15,5 cm	Blumenthal bone ronguers; 15,5 cm	195
116 91 0524	Blumenthal kleště štípací na kosti; 15,5 cm	Blumenthal bone ronguers; 15,5 cm	195
116 91 0527	Luer kleště štípací na kosti; 15,0 cm	Luer bone ronguers; 15,0 cm	195
116 91 0528	Luer kleště štípací na kosti; 15,0 cm	Luer bone ronguers; 15,0 cm	195
116 91 0529	Luer kleště štípací na kosti; 15,0 cm	Luer bone ronguers; 15,0 cm	195
116 91 0539	Hercules kleště štípací na drát; 23,0 cm	Hercules wire cutting forceps; 23,0 cm	221
116 91 0540	Sada gumových čelistí pro štípací kleště Hercules	Set of rubber jaws for forceps Hercules	221
116 91 0541	Sada čelistí pro štípací kleště Hercules	Set of jaws for forceps Hercules	221
116 91 0548	Kleště na žebra srpovitě; 22 cm	Rib Forceps curved; 22 cm	204
116 91 0549	Bethune kleště na žebra; 34 cm	Bethune rib forceps; 34 cm	204
116 91 0550	Sauerbruch kleště na žebra; 26 cm	Sauerbruch rib forceps; 26 cm	204
116 91 0551	Coryllos kleště na žebra levé; 35 cm	Coryllos rib forceps left; 35 cm	204
116 91 0552	Coryllos kleště na žebra pravé; 35 cm	Coryllos rib forceps right; 35 cm	204
116 91 0553	Sauerbruch-Frey kleště na žebra; 36 cm	Sauerbruch-Frey forceps for ribs; 36 cm	205
116 91 0555	Brunner kleště na žebra pro pravou ruku; 28 cm	Brunner rib forceps for right hand; 28 cm	205
116 91 0556	Brunner kleště na žebra pro levou ruku; 28 cm	Brunner rib forceps for left hand; 28 cm	205
117	KLEŠTĚ ÚCHOPNÉ	GRASPING FORCEPS	
117 05 0010	Wolff kleště na drcení sádrových obvazů; 25,5 cm	Wolff plaster cast forceps; 25,5 cm	225

číslo – number	název	item	strana – page
117 07 0030	Magill kleště na zavádění endotrach. rourek; 22,0 cm	Magill catheter introducing forceps; 22,0 cm	226
117 07 0040	Kleště na hadici; 16,0 cm	Tubing forceps; 16,0 cm	190
117 08 0020	Kleště na kostní úlomky; 20,0 cm	Sequestrum forceps; 20,0 cm	227
117 08 0040	Fergusson kleště na držení kostí; 20,0 cm	Fergusson bone holding forceps; 20,0 cm	227
117 09 0050	Kleště úchopné na drát; 18,0 mm	Wire grasping forceps; 18,0 mm	226
117 09 0130	Kleště na držení kostí reperiční; 10,0 mm; 17,3 cm	Bone holding forceps; 10,0 mm; 17,3 cm	230
117 09 0140	Kleště na držení kostí reperiční; 5,0 mm; 17,3 cm	Bone holding forceps; 5,0 mm; 17,3 cm	230
117 09 0150	Kleště na držení kostí reperiční; 8,0 mm; 17,3 cm	Bone holding forceps; 8,0 mm; 17,3 cm	230
117 09 0160	Kleště na držení kostí reperiční; 12,0 mm; 17,3 cm	Bone holding forceps; 12,0 mm; 17,3 cm	230
117 09 0170	Novák kleště na držení kostí reperiční; 18 mm; 18,0 cm	Novak bone holding forceps; 18 mm; 18,0 cm	230
117 09 0180	Novák kleště na držení kostí reperiční; 24 mm; 18,0 cm	Novak bone holding forceps; 24 mm; 18,0 cm	230
117 09 0190	Novák kleště na držení kostí reperiční; 30 mm; 18,0 cm	Novak bone holding forceps; 30 mm; 18,0 cm	230
117 09 0260	Bartl kleště na vytažení kostních prutů; 21,5 cm	Bartl nail extraction forceps; 21,5 cm	227
117 09 0270	Bartl kleště na vytažení kostních prutů jemný; 21,5 cm	Bartl nail extraction forceps; 21,5 cm	227
117 14 0110	Duval kleště na plíce okénkóvé; 16 mm; 22,0 cm	Duval lung grasping forceps; 16 mm; 22,0 cm	234
117 14 0120	Duval kleště na plíce okénkóvé; 21 mm; 22,0 cm	Duval lung grasping forceps; 21 mm; 22,0 cm	234
117 14 0130	Duval kleště na plíce okénkóvé; 26 mm; 22,0 cm	Duval lung grasping forceps; 26 mm; 22,0 cm	234
117 19 0020	Kleště na hemoroidy; 20,0 cm	Haemorrhoids forceps; 20,0 cm	235
117 19 0070	Allis kleště na střeva; 21,0 cm	Allis intestinal forceps; 21,0 cm	235
117 22 0150	Collin kleště na nádory; 15,0 mm; 24,0 cm	Collin tumor forceps; 15,0 mm; 24,0 cm	235
117 22 0160	Collin kleště na výrůstky; 18,0 mm; 24,0 cm	Collin tumor forceps; 18,0 mm; 24,0 cm	235
117 22 0270	Randall kleště na ledvinové kameny fig.1; 21,0 cm	Randall kidney stone forceps fig.1; 21,0 cm	236
117 22 0280	Randall kleště na ledvinové kameny fig.2; 19,8 cm	Randall kidney stone forceps fig.2; 19,8 cm	236
117 22 0290	Randall kleště na ledvinové kameny fig.3; 18,5 cm	Randall kidney stone forceps fig.3; 18,5 cm	236
117 27 0010	Schröder kleště jednoháčkové; 25,0 cm	Schröder gynaecological forceps; 25,0 cm	237
117 27 0020	Schröder kleště dvouháčkové; 25,0 cm	Schröder gynaecological forceps; 25,0 cm	237
117 27 0050	Kleště dvouháčkové na čípek; 25,0 cm	Gynaecological forceps; 25,0 cm	237
117 27 0150	Kleště na cervix; 26,0 cm	Gynaecological forceps; 26,0 cm	237
117 27 0260	Gross-Maier kleště tamponové rovné s uzávěrem; 26,0 cm	Gross-Maier sponge holding forceps; 26,0 cm	241
117 27 0270	Kleště tamponové rovné bez uzávěru; 25,7 cm	Sponge holding forceps; 25,7 cm	241
117 27 0280	Gross-Maier kleště tamponové zahnuté s uzávěrem; 25,7 cm	Gross-Maier sponge holding forceps; 25,7 cm	241
117 27 0290	Kleště tamponové zahnuté bez uzávěru; 25,7 cm	Sponge holding forceps; 25,7 cm	241
117 27 0500	Bozemann kleště tamponové prohnuté hladké; 25,0 cm	Bozemann sponge holding forceps; 25,0 cm	239
117 27 0510	Bozemann kleště tamponové prohnuté s vroub. čel.; 25,0 cm	Bozemann sponge holding forceps; 25,0 cm	239
117 28 0010	Winter kleště potratové bez uzávěru rovné; 28,0 cm	Winter abortion forceps; 28,0 cm	237
117 28 0020	Winter kleště potratové bez uzávěru zahnuté; 27,5 cm	Winter abortion forceps; 27,5 cm	237
117 29 0060	Kleště ušní úchopné jemné; 0,6×0,9×3,5 mm; 6,8 cm; 13,0 cm	Ear forceps; 0,6×0,9×3,5 mm; 6,8 cm; 13,0 cm	244
117 29 0070	Kleště ušní úchopné jemné; 0,6×0,9×5,5 mm; 7,0 cm; 13,0 cm	Ear forceps; 0,6×0,9×5,5 mm; 7,0 cm; 13,0 cm	244
117 29 0090	Kleště ušní úchopné jemné; 1,5×4,5 mm; 7,8 cm; 13,0 cm	Ear forceps; 1,5×4,5 mm; 7,8 cm; 13,0 cm	244
117 29 0100	Kleště ušní úchopné jemné; 2,0×7,0 mm; 8,3 cm; 13,0 cm	Ear forceps; 2,0×7,0 mm; 8,3 cm; 13,0 cm	244
117 29 0130	Kleště ušní zahnuté levé jemné; 0,6×0,9×3,5 mm; 6,8 cm; 13,0 cm	Ear forceps; 0,6×0,9×3,5 mm; 6,8 cm; 13,0 cm	244
117 29 0140	Kleště ušní zahnuté pravé jemné; 0,6×0,9×3,5 mm; 6,8 cm; 13,0 cm	Ear forceps; 0,6×0,9×3,5 mm; 6,8 cm; 13,0 cm	244
117 29 0400	Kleště ušní úchopné; 0,8×2,0×5,0 mm; 9,8 cm; 16,0 cm	Ear forceps; 0,8×2,0×5,0 mm; 9,8 cm; 16,0 cm	244
117 29 0410	Kleště ušní úchopné; 0,2×2,0×5,0 mm; 9,8 cm; 16,0 cm	Ear forceps; 0,2×2,0×5,0 mm; 9,8 cm; 16,0 cm	244
117 29 0420	Kleště ušní zahnuté vlevo; 0,8×2,0×5,0 mm; 9,8 cm; 16,0 cm	Ear forceps; 0,8×2,0×5,0 mm; 9,8 cm; 16,0 cm	244
117 29 0430	Kleště ušní zahnuté vpravo; 0,8×2,0×5,0 mm; 9,8 cm; 16,0 cm	Ear forceps; 0,8×2,0×5,0 mm; 9,8 cm; 16,0 cm	244
117 29 0440	Kleště ušní úchopné; 0,5×2,0×5,0 mm; 9,8 cm; 16,0 cm	Ear forceps; 0,5×2,0×5,0 mm; 9,8 cm; 16,0 cm	244
117 29 0450	Kleště ušní úchopné; 0,8×8,5×8,5 mm; 10,2 cm; 16,0 cm	Ear forceps; 0,8×8,5×8,5 mm; 10,2 cm; 16,0 cm	244
117 29 0460	Kleště ušní úchopné; 30°; 0,8×2,0×5,0 mm; 9,8 cm; 16,0 cm	Ear forceps; 30°; 0,8×2,0×5,0 mm; 9,8 cm; 16,0 cm	244
117 29 0470	Kleště ušní úchopné; 1,2×2,0×5,0 mm; 9,8 cm; 16,0 cm	Ear forceps; 1,2×2,0×5,0 mm; 9,8 cm; 16,0 cm	244
117 29 0480	Kleště ušní úchopné se zoubky; 1,5×2,0×8,0 mm; 9,8 cm; 16,0 cm	Ear forceps; 1,5×2,0×8,0 mm; 9,8 cm; 16,0 cm	244
117 30 0100	Hartmann kleště na nosní polypy; 3,0 mm; 20,4 cm	Hartmann nasal polypus forceps; 3,0 mm; 20,4 cm	245
117 30 0110	Hartmann kleště na nosní polypy; 4,0 mm; 20,4 cm	Hartmann nasal polypus forceps; 4,0 mm; 20,4 cm	245
117 30 0400	Kleště na nosní skořepu; 4,0 mm; 18,3 cm	Nasal septum forceps; 4,0 mm; 18,3 cm	245
117 30 0410	Kleště na nosní skořepu; 7,0 mm; 18,3 cm	Nasal septum forceps; 7,0 mm; 18,3 cm	245
117 31 0010	Collin kleště na jazyk okénkóvé; 16,7 cm	Collin tongue holding forceps; 16,7 cm	246
117 31 0030	Löbker kleště na jazyk jednoháčkové; 15,0 cm	Löbker tongue holding forceps; 15,0 cm	246
117 91 0001	Lister kleště tamponové; 13,0 cm	Lister sinus forceps; 13,0 cm	238
117 91 0002	Lister kleště tamponové; 16,0 cm	Lister sinus forceps; 16,0 cm	238
117 91 0003	Lister kleště tamponové; 18,0 cm	Lister sinus forceps; 18,0 cm	238
117 91 0004	Ulrich kleště na polypy rovné; 22,0 cm	Ulrich polypus forceps; 22,0 cm	238
117 91 0005	Ulrich kleště na polypy rovné; 25,0 cm	Ulrich polypus forceps; 25,0 cm	238
117 91 0007	Ulrich kleště na polypy zahnuté; 22,0 cm	Ulrich polypus forceps; 22,0 cm	238
117 91 0008	Ulrich kleště na polypy zahnuté; 25,0 cm	Ulrich polypus forceps; 25,0 cm	238
117 91 0033	Collin kleště tamponové; 24,0 cm	Collin dressing forceps; 24,0 cm	239
117 91 0034	Notto kleště na polypy; 27,5 cm	Notto polypus forceps; 27,5 cm	239
117 91 0035	Pelkmann kleště tamponové rovné; 25,0 cm	Pelkmann dressing forceps; 25,0 cm	240
117 91 0037	Kelly kleště na polypy; 32,0 cm	Kelly polypus forceps; 32,0 cm	240
117 91 0038	Heywood-Smith kleště tamponové; 21,0 cm	Heywood-Smith forceps; 21,0 cm	240
117 91 0039	Heywood-Smith kleště tamponové; 25,0 cm	Heywood-Smith forceps screw; 25,0 cm	240
117 91 0042	Foerster-Ballenger kleště tamponové rovné vroubk.; 18,0 cm	Foerster-Ballenger forceps str serrated; 18,0 cm	242

číslo – number	název	item	strana – page
117 91 0044	Foerster-Ballenger kleště tamponové rovné vroubk.; 25,0 cm	Foerster-Ballenger forceps str serrated; 25,0 cm	242
117 91 0045	Foerster-Ballenger kleště tamponové Zahn. vroubk.; 18,0 cm	Foerster-Ballenger forceps cvd serrated; 18,0 cm	242
117 91 0047	Foerster-Ballenger kleště tamponové Zahn. vroubk.; 25,0 cm	Foerster-Ballenger forceps cvd serrated; 25,0 cm	242
117 91 0048	Foerster-Ballenger kleště tamponové rovné hladké; 18,0 cm	Foerster-Ballenger forceps str smooth; 18,0 cm	242
117 91 0050	Foerster-Ballenger kleště tamponové rovné hladké; 25,0 cm	Foerster-Ballenger forceps str smooth; 25,0 cm	242
117 91 0051	Foerster-Ballenger kleště tamponové Zahn. hladké; 18,0 cm	Foerster-Ballenger forceps cvd smooth; 18,0 cm	242
117 91 0053	Foerster-Ballenger kleště tamponové Zahn. hladké; 25,0 cm	Foerster-Ballenger forceps cvd smooth; 25,0 cm	242
117 91 0054	Foerster kleště tamponové úzké rovné; 25,0 cm	Foerster sponge holding forceps; 25,0 cm	243
117 91 0055	Foerster kleště tamponové úzké zahnuté; 25,0 cm	Foerster sponge holding forceps; 25,0 cm	243
117 91 0056	Rampléy kleště tamponové; 25,0 cm	Rampléy sponge holding forceps; 25,0 cm	243
117 91 0063	Henning kleště na sádrové obvazy; 28,0 cm	Henning plaster cast spreader; 28,0 cm	225
117 91 0064	Beeson kleště na sádrové obvazy; 30,0 cm	Beeson plaster cast spreader; 30,0 cm	225
117 91 0066	Wolff kleště na sádrové obvazy; 18,0 cm	Wolff plaster cast forceps; 18,0 cm	225
117 91 0067	Wolff kleště na sádrové obvazy; 24,0 cm	Wolff plaster cast forceps; 24,0 cm	225
117 91 0069	Stille kleště na sádrové obvazy; 23,0 cm	Stille plaster of paris shears; 23,0 cm	225
117 91 0070	Stille kleště na sádrové obvazy; 26,0 cm	Stille plaster of paris shears; 26,0 cm	225
117 91 0071	Stille kleště na sádrové obvazy; 37,0 cm	Stille plaster of paris shears; 37,0 cm	225
117 91 0072	Magill kleště na zavedení endotrach. rourek	Magill catheter introducing forceps	226
117 91 0073	Magill kleště na zavedení endotrach. rourek	Magill catheter introducing forceps	226
117 91 0074	Magill kleště na zavedení endotrach. rourek	Magill catheter introducing forceps	226
117 91 0080	Kleště úchopné na drát; 17,0 mm	Wire grasping forceps; 17,0 mm	226
117 91 0081	Kleště úchopné na drát; 17,0 mm	Wire grasping forceps; 17,0 mm	226
117 91 0082	Kleště úchopné na drát; 15,0 mm	Wire grasping forceps; 15,0 mm	226
117 91 0117	Farabeuf-Lambotte kleště repositionní; 26,0 cm	Farabeuf-Lambotte reposition forceps; 26,0 cm	232
117 91 0118	Farabeuf kleště repositionní; 23,0 cm	Farabeuf reposition forceps; 23,0 cm	232
117 91 0119	Farabeuf kleště repositionní; 26,0 cm	Farabeuf reposition forceps; 26,0 cm	232
117 91 0120	Verbrugge kleště repositionní; 17,5 cm	Verbrugge reposition forceps; 17,5 cm	233
117 91 0121	Verbrugge kleště repositionní; 25,0 cm	Verbrugge reposition forceps; 25,0 cm	233
117 91 0122	Verbrugge kleště repositionní; 26,0 cm	Verbrugge reposition forceps; 26,0 cm	233
117 91 0123	Verbrugge kleště repositionní; 27,0 cm	Verbrugge reposition forceps; 27,0 cm	233
117 91 0133	Kleště repositionní; 15,0 cm	Reposition forceps; 15,0 cm	231
117 91 0134	Kleště repositionní; 19,0 cm	Reposition forceps; 19,0 cm	231
117 91 0135	Kleště repositionní; 24,0 cm	Reposition forceps; 24,0 cm	231
117 91 0136	Kleště repositionní; 26,0 cm	Reposition forceps; 26,0 cm	231
117 91 0137	Kleště repositionní; 28,0 cm	Reposition forceps; 28,0 cm	231
117 99 0039	Kleště na držení kostí s kuličkou 4 mm; 23,5 cm	Bone forceps with ball 4 mm; 23,5 cm	228
117 99 0041	Kleště na držení kostí stavěcí; 25,0 cm	Bone forceps; 25,0 cm	229
117 99 0044	Kleště na držení kostí s kuličkou 5 mm; 23,5 cm	Bone forceps with ball 5 mm; 23,5 cm	228
118	HÁKY	HOOKS, RETRACTORS	
118 08 0010	Háček na rány jednozubý ostrý; 16,5 cm	Delicate hook 1 prong sharp; 16,5 cm	249
118 08 0020	Háček na rány dvouzubý ostrý; 16,5 cm	Delicate hook 2 prongs sharp; 16,5 cm	249
118 08 0050	Háček na rány jednozubý tupý; 16,5 cm	Delicate hook 1 prong blunt; 16,5 cm	249
118 08 0060	Háček na rány dvouzubý tupý; 16,5 cm	Delicate hook 2 prongs blunt; 16,5 cm	249
118 08 0310	Volkman hák na rány jednozubý ostrý fig.1; 21,5 cm	Volkman retractor 1 prong sharp fig.1; 21,5 cm	254
118 08 0320	Volkman hák na rány jednozubý ostrý fig.2; 21,5 cm	Volkman retractor 1 prong sharp fig.2; 21,5 cm	255
118 08 0330	Volkman hák na rány jednozubý tupý fig.3; 21,5 cm	Volkman retractor 1 prong blunt fig.3; 21,5 cm	254
118 08 0340	Volkman hák na rány jednozubý tupý fig.4; 21,5 cm	Volkman retractor 1 prong blunt fig.4; 21,5 cm	255
118 08 0350	Volkman hák na rány dvouzubý ostrý; 21,5 cm	Volkman retractor 2 prongs sharp; 21,5 cm	254
118 08 0360	Volkman hák na rány dvouzubý tupý; 21,5 cm	Volkman retractor 2 prongs blunt; 21,5 cm	254
118 08 0390	Volkman hák na rány čtyřzubý ostrý; 22,4 cm	Volkman retractor 4 prongs sharp; 22,4 cm	254
118 08 0400	Volkman hák na rány čtyřzubý tupý; 22,4 cm	Volkman retractor 4 prongs blunt; 22,4 cm	254
118 08 0410	Volkman hák na rány šestizubý ostrý; 22,0 cm	Volkman retractor 6 prongs sharp; 22,0 cm	254
118 08 0420	Volkman hák na rány šestizubý tupý; 22,0 cm	Volkman retractor 6 prongs blunt; 22,0 cm	254
118 08 0430	Volkman hák na rány desetizubý ostrý; 26,0 cm	Volkman retractor 10 prongs sharp; 26,0 cm	255
118 08 0440	Volkman hák na rány desetizubý tupý; 26,0 cm	Volkman retractor 10 prongs blunt; 26,0 cm	255
118 08 0530	Israel hák na rány čtyřzubý tupý; 40×35 mm; 24,0 cm	Israel retractor 4 prongs blunt; 40×35 mm; 24,0 cm	256
118 08 0540	Israel hák na rány šestizubý tupý; 45×68 mm; 26,0 cm	Israel retractor 6 prongs blunt; 45×68 mm; 26,0 cm	256
118 08 0550	Kocher hák břišní; 80×40 mm; 25,0 cm	Kocher abdominal retractor; 80×40 mm; 25,0 cm	264
118 08 0560	Kocher hák břišní; 80×50 mm; 25,0 cm	Kocher abdominal retractor; 80×50 mm; 25,0 cm	264
118 08 0650	Middeldorpf hák na rány okénk.; 14×12 mm; 22,0 cm	Middeldorpf retractor; 14×12 mm; 22,0 cm	260
118 08 0660	Middeldorpf hák na rány okénk.; 21×21 mm; 22,0 cm	Middeldorpf retractor; 21×21 mm; 22,0 cm	260
118 08 0670	Middeldorpf hák na rány okénk.; 32×31 mm; 23,5 cm	Middeldorpf retractor; 32×31 mm; 23,5 cm	260
118 08 0680	Middeldorpf hák na rány okénk.; 62×50 mm; 28,0 cm	Middeldorpf retractor; 62×50 mm; 28,0 cm	260
118 08 0710	Semb hák na rány třízubý; 23,8 cm	Semb retractor 3 prongs; 23,8 cm	262
118 08 0720	Semb hák na rány čtyřzubý; 24,6 cm	Semb retractor 4 prongs; 24,6 cm	262
118 08 0760	Caldwell-Luc hák na rány; 12×13 mm; 23,0 cm	Caldwell-Luc retractor; 12×13 mm; 23,0 cm	261
118 08 0770	Caldwell-Luc hák na rány; 37×13 mm; 23,0 cm	Caldwell-Luc retractor; 37×13 mm; 23,0 cm	261
118 08 0780	Caldwell-Luc hák na rány; 35×13 mm; 23,0 cm	Caldwell-Luc retractor; 35×13 mm; 23,0 cm	261
118 08 0800	Langenbeck hák na rány; 40×10 mm; 21,0 cm	Langenbeck retractor; 40×10 mm; 21,0 cm	257
118 08 0810	Langenbeck hák na rány; 42×13 mm; 21,0 cm	Langenbeck retractor; 42×13 mm; 21,0 cm	257
118 08 0840	Langenbeck hák na rány; 55×13 mm; 21,0 cm	Langenbeck retractor; 55×13 mm; 21,0 cm	257

číslo – number	název	item	strana – page
118 08 1050	Kocher hák na rány ploché; 40×35 mm; 23,0 cm	Kocher abdominal retractor; 40×35 mm; 23,0 cm	258
118 08 1060	Kocher hák na rány ploché; 70×35 mm; 23,0 cm	Kocher abdominal retractor; 70×35 mm; 23,0 cm	258
118 08 1070	Kocher hák na rány ploché; 100×40 mm; 23,0 cm	Kocher abdominal retractor; 100×40 mm; 23,0 cm	258
118 08 1080	Hák břišní ploché; 120×30 mm; 24,0 cm	Abdominal retractor; 120×30 mm; 24,0 cm	263
118 08 1090	Hák břišní ploché; 140×50 mm; 24,5 cm	Abdominal retractor; 140×50 mm; 24,5 cm	263
118 08 1100	Mikulicz hák břišní prohnutý; 115×30 mm; 26,0 cm	Mikulicz abdominal retractor; 115×30 mm; 26,0 cm	265
118 08 1110	Mikulicz hák břišní prohnutý; 135×50 mm; 26,0 cm	Mikulicz abdominal retractor; 135×50 mm; 26,0 cm	265
118 08 1120	Fritsch hák břišní; 40×35 mm; 25,5 cm	Fritsch abdominal retractor; 40×35 mm; 25,5 cm	263
118 08 1130	Fritsch hák břišní; 50×80 mm; 27,0 cm	Fritsch abdominal retractor; 50×80 mm; 27,0 cm	263
118 12 0010	Háček pro plastiku jednozubý ostrý fig.1; 16,0 cm	Plastic hook 1 prong sharp fig.1; 16,0 cm	269
118 12 0020	Háček pro plastiku jednozubý ostrý fig.2; 16,0 cm	Plastic hook 1 prong sharp fig.2; 16,0 cm	269
118 12 0050	Háček pro plastiku dvouzubý tupý; 5,0 mm; 16,0 cm	Plastic hook 2 prongs blunt; 5,0 mm; 16,0 cm	269
118 12 0060	Háček pro plastiku dvouzubý ostrý; 5,0 mm; 16,0 cm	Plastic hook 2 prongs sharp; 5,0 mm; 16,0 cm	269
118 12 0070	Háček pro plastiku čtyřzubý tupý; 12,0 mm; 16,0 cm	Plastic hook 4 prongs blunt; 12,0 mm; 16,0 cm	269
118 12 0080	Háček pro plastiku čtyřzubý ostrý; 12,0 mm; 16,0 cm	Plastic hook 4 prongs sharp; 12,0 mm; 16,0 cm	269
118 12 0090	Háček na křídlo nosní oboustranný; 10,5 cm	Nasal alar hook; 10,5 cm	269
118 14 0020	Hák na plícnici; 15 mm; 18,8 cm; 22 cm	Pleura retractor; 15 mm; 18,8 cm; 22 cm	268
118 14 0030	Hák na plícnici; 20 mm; 18,8 cm; 22 cm	Pleura retractor; 20 mm; 18,8 cm; 22 cm	268
118 14 0040	Hák na plícnici; 25 mm; 19,2 cm; 22 cm	Pleura retractor; 25 mm; 19,2 cm; 22 cm	268
118 17 0010	Háček na tvrdou plenu mozkovou; 16,0 cm	Dura hook; 16,0 cm	269
118 17 0020	Háček na nervy jednozubý ostrý; 15,5 cm	Nerve hook 1 prong sharp; 15,5 cm	269
118 28 0010	Smellie hák dekapitační a porodnický; 32,0 cm	Smellie decapitation hook; 32,0 cm	271
118 29 0010	Hartmann háček ušní jednozubý ostrý; 17,0 cm	Hartmann ear hook 1 prong sharp; 17,0 cm	272
118 29 0040	Berthold háček ušní jednozubý ostrý bajonet.; 18,0 cm	Berthold ear hook 1 prong sharp; 18,0 cm	272
118 29 0060	Schwartz háček ušní tupý pravouhle zahnutý; 17,0 cm	Schwartz ear hook blunt; 17,0 cm	272
118 29 0070	Troeltsch hák na zvukovod; 20,5 cm	Troeltsch sound hook; 20,5 cm	272
118 29 0140	Ludewig háček na kovadlinku levý; 17,0 cm	Ludewig incus hook; 17,0 cm	272
118 29 0150	Ludewig háček na kovadlinku pravý; 17,0 cm	Ludewig incus hook; 17,0 cm	272
118 30 0120	Hák na choanální polypy; 22,5 cm	Choanal hook; 22,5 cm	272
118 31 0040	Hák resekční čtyřzubý rovný; 16,4 cm	Resection hook 4 prongs straight; 16,4 cm	274
118 31 0050	Hák resekční čtyřzubý pravý; 16,2 cm	Resection hook 4 prongs right; 16,2 cm	274
118 31 0060	Hák resekční čtyřzubý levý; 16,2 cm	Resection hook 4 prongs left; 16,2 cm	274
118 31 0070	Hák resekční dvouzubý rovný; 16,4 cm	Resection hook 2 prongs straight; 16,4 cm	274
118 31 0080	Hák resekční dvouzubý pravý; 16,1 cm	Resection hook 2 prongs right; 16,1 cm	274
118 31 0090	Hák resekční dvouzubý levý; 16,1 cm	Resection hook 2 prongs left; 16,1 cm	274
118 34 0020	Hák tracheální ploché; 19×11 mm; 23,5 cm	Tracheal hook; 19×11 mm; 23,5 cm	273
118 34 0030	Hák tracheální dvakrát lomený; 16,5×5,0 mm; 21,0 cm	Tracheal hook; 16,5×5,0 mm; 21,0 cm	273
118 38 0010	Desmarres držátko víček; 10,0 mm; 13,0 cm	Desmarres delicate hook; 10,0 mm; 13,0 cm	251
118 38 0020	Desmarres držátko víček; 12,0 mm; 13,0 cm	Desmarres delicate hook; 12,0 mm; 13,0 cm	251
118 38 0030	Desmarres držátko víček; 14,0 mm; 13,0 cm	Desmarres delicate hook; 14,0 mm; 13,0 cm	251
118 38 0050	Graefe háček na duhovku ostrý; 13,0 cm	Graefe iris hook sharp; 13,0 cm	252
118 38 0060	Graefe háček na duhovku tupý; 14,0 cm	Graefe iris hook blunt; 14,0 cm	252
118 38 0090	Háček na čočkové pouzdro tupý; 14,0 cm	Capsule hook blunt; 14,0 cm	252
118 38 0210	Háček oční dvouzubý ostrý; 2,6 mm; 13,5 cm	Eye hook 2 prongs sharp; 2,6 mm; 13,5 cm	252
118 38 0220	Háček oční dvouzubý ostrý; 3,2 mm; 13,5 cm	Eye hook 2 prongs sharp; 3,2 mm; 13,5 cm	252
118 38 0230	Háček oční dvouzubý ostrý; 4,0 mm; 13,5 cm	Eye hook 2 prongs sharp; 4,0 mm; 13,5 cm	252
118 38 0360	Háček oční čtyřzubý ostrý; 5,0 mm; 14,5 cm	Eye hook 4 prongs sharp; 5,0 mm; 14,5 cm	252
118 38 0370	Háček oční čtyřzubý ostrý; 10,0 mm; 15,0 cm	Eye hook 4 prongs sharp; 10,0 mm; 15,0 cm	252
118 38 0420	Graefe háček na operaci šilhání; 9,0 mm; 14,5 cm	Graefe strabismus hook; 9,0 mm; 14,5 cm	252
118 38 0460	Jaeger háček na operaci šilhání; 14,5 cm	Jaeger strabismus hook; 14,5 cm	252
118 38 0500	Háček na oční sval; 14 cm	Trochlearis retractor; 14 cm	252
118 91 0008	Hák jemný fig.1; 16,0 cm	Delicate hook fig.1; 16,0 cm	250
118 91 0009	Hák jemný fig.2; 16,0 cm	Delicate hook fig.2; 16,0 cm	250
118 91 0010	Hák jemný fig.3; 16,0 cm	Delicate hook fig.3; 16,0 cm	250
118 91 0011	Hák jemný fig.4; 16,0 cm	Delicate hook fig.4; 16,0 cm	250
118 91 0013	Graefe hák jemný ostrý; 16,0 cm	Graefe delicate hook sharp; 16,0 cm	250
118 91 0014	Graefe hák jemný tupý; 16,0 cm	Graefe delicate hook blunt; 16,0 cm	250
118 91 0015	Cushing hák jemný fig.1; 28,0 cm	Cushing delicate hook fig.1; 28,0 cm	250
118 91 0016	Cushing hák jemný fig.2; 28,0 cm	Cushing delicate hook fig.2; 28,0 cm	250
118 91 0017	Cushing hák jemný fig.1; 19,0 cm	Cushing delicate hook fig.1; 19,0 cm	250
118 91 0018	Cushing hák jemný fig.2; 19,0 cm	Cushing delicate hook fig.2; 19,0 cm	250
118 91 0027	Hák jemný třízubý ostrý; 16,0 cm	Retractor sharp 3 prongs; 16,0 cm	249
118 91 0028	Hák jemný čtyřzubý ostrý; 16,0 cm	Retractor sharp 4 prongs; 16,0 cm	249
118 91 0035	Hák jemný třízubý tupý; 16,0 cm	Retractor blunt 3 prongs; 16,0 cm	249
118 91 0036	Hák jemný čtyřzubý tupý; 16,0 cm	Retractor blunt 4 prongs; 16,0 cm	249
118 91 0045	Hák jemný dvouzubý ohebný ostrý; 16,0 cm	Retractor sharp flex. 2 prongs; 16,0 cm	249
118 91 0046	Hák jemný třízubý ohebný ostrý; 16,0 cm	Retractor sharp flex. 3 prongs; 16,0 cm	249
118 91 0047	Hák jemný čtyřzubý ohebný ostrý; 16,0 cm	Retractor sharp flex. 4 prongs; 16,0 cm	249
118 91 0048	Hák jemný dvouzubý ohebný tupý; 16,0 cm	Retractor blunt flex. 2 prongs; 16,0 cm	249
118 91 0049	Hák jemný třízubý ohebný tupý; 16,0 cm	Retractor blunt flex. 3 prongs; 16,0 cm	249
118 91 0050	Hák jemný čtyřzubý ohebný tupý; 16,0 cm	Retractor blunt flex. 4 prongs; 16,0 cm	249

číslo – number	název	item	strana – page
118 91 0051	Joseph hák jemný; 16,0 cm	Joseph delicate hook; 16,0 cm	249
118 91 0052	Joseph hák jemný; 2,0 mm; 16,0 cm	Joseph delicate hook; 2,0 mm; 16,0 cm	249
118 91 0053	Joseph hák jemný; 5,0 mm; 16,0 cm	Joseph delicate hook; 5,0 mm; 16,0 cm	249
118 91 0054	Joseph hák jemný; 7,0 mm; 16,0 cm	Joseph delicate hook; 7,0 mm; 16,0 cm	249
118 91 0055	Joseph hák jemný; 10,0 mm; 16,0 cm	Joseph delicate hook; 10,0 mm; 16,0 cm	249
118 91 0069	Mini-Langenbeck hák jemný; 10×6 mm; 16,0cm	Mini-Langenbeck retractor; 10×6 mm; 16,0cm	251
118 91 0070	Mini-Langenbeck hák jemný; 17×5 mm; 16,0cm	Mini-Langenbeck retractor; 17×5 mm; 16,0cm	251
118 91 0071	Mini-Langenbeck hák jemný; 20×6 mm; 16,0cm	Mini-Langenbeck retractor; 20×6 mm; 16,0cm	251
118 91 0072	Mini-Langenbeck hák jemný; 22×8 mm; 16,0cm	Mini-Langenbeck retractor; 22×8 mm; 16,0cm	251
118 91 0077	Desmarres držátko víček; 16,0 mm; 13,0 cm	Desmarres delicate hook; 16,0 mm; 13,0 cm	251
118 91 0078	Desmarres držátko víček; 18,0 mm; 13,0 cm	Desmarres delicate hook; 18,0 mm; 13,0 cm	251
118 91 0085	Cushing hák jemný; 8,0 mm; 20,0 cm	Cushing delicate hook; 8,0 mm; 20,0 cm	251
118 91 0086	Cushing hák jemný; 10,0 mm; 20,0 cm	Cushing delicate hook; 10,0 mm; 20,0 cm	251
118 91 0087	Cushing hák jemný; 12,0 mm; 20,0 cm	Cushing delicate hook; 12,0 mm; 20,0 cm	251
118 91 0088	Cushing hák jemný; 14,0 mm; 20,0 cm	Cushing delicate hook; 14,0 mm; 20,0 cm	251
118 91 0089	Cushing hák jemný; 16,0 mm; 20,0 cm	Cushing delicate hook; 16,0 mm; 20,0 cm	251
118 91 0090	Cushing hák jemný; 18,0 mm; 20,0 cm	Cushing delicate hook; 18,0 mm; 20,0 cm	251
118 91 0091	Cushing hák jemný; 8,0 mm; 24,0 cm	Cushing delicate hook; 8,0 mm; 24,0 cm	251
118 91 0092	Cushing hák jemný; 10,0 mm; 24,0 cm	Cushing delicate hook; 10,0 mm; 24,0 cm	251
118 91 0093	Cushing hák jemný; 12,0 mm; 24,0 cm	Cushing delicate hook; 12,0 mm; 24,0 cm	251
118 91 0094	Cushing hák jemný; 14,0 mm; 24,0 cm	Cushing delicate hook; 14,0 mm; 24,0 cm	251
118 91 0095	Cushing hák jemný; 16,0 mm; 24,0 cm	Cushing delicate hook; 16,0 mm; 24,0 cm	251
118 91 0096	Cushing hák jemný; 18,0 mm; 24,0 cm	Cushing delicate hook; 18,0 mm; 24,0 cm	251
118 91 0097	Gil-Vernet hák páteřní jemný; 9,0 mm; 24,5 cm	Gil-Vernet spinal hook; 9,0 mm; 24,5 cm	253
118 91 0098	Gil-Vernet hák páteřní jemný; 11,0 mm; 24,5 cm	Gil-Vernet spinal hook; 11,0 mm; 24,5 cm	253
118 91 0100	Gil-Vernet hák páteřní jemný; 15,0 mm; 24,5 cm	Gil-Vernet spinal hook; 15,0 mm; 24,5 cm	253
118 91 0101	Gil-Vernet hák páteřní jemný; 18,0 mm; 24,5 cm	Gil-Vernet spinal hook; 18,0 mm; 24,5 cm	253
118 91 0109	Senn-Miller hák páteřní jemný ostrý; 16,0 cm	Senn-Miller spinal hook sharp; 16,0 cm	253
118 91 0110	Senn-Miller hák páteřní jemný tupý; 16,0 cm	Senn-Miller spinal hook blunt; 16,0 cm	253
118 91 0135	Kocher hák na rány osmizubý ostrý; 22,0 cm	Kocher retractor 8 prongs sharp; 22,0 cm	254
118 91 0147	Kocher hák na rány osmizubý tupý; 22,0 cm	Kocher retractor 8 prongs blunt; 22,0 cm	254
118 91 0152	Koerte hák na rány; 26×40 mm; 24,0 cm	Koerte retractor; 26×40 mm; 24,0 cm	255
118 91 0153	Koerte hák na rány; 26×40 mm; 24,0 cm	Koerte retractor; 26×40 mm; 24,0 cm	255
118 91 0160	Israel hák na rány pětizubý; 45×50 mm; 25,0 cm	Israel retractor 5 prongs; 45×50 mm; 25,0 cm	256
118 91 0162	Israel hák na rány šestizubý; 70×70mm; 25,0 cm	Israel retractor 6 prongs; 70×70mm; 25,0 cm	256
118 91 0163	Langenbeck hák na rány; 55×20 mm; 21,0 cm	Langenbeck retractor; 55×20 mm; 21,0 cm	257
118 91 0164	Langenbeck hák na rány; 60×20 mm; 21,0 cm	Langenbeck retractor; 60×20 mm; 21,0 cm	257
118 91 0165	Langenbeck hák na rány; 63×20 mm; 21,0 cm	Langenbeck retractor; 63×20 mm; 21,0 cm	257
118 91 0185	Kocher hák na rány; 40×18 mm; 23,0 cm	Kocher retractor; 40×18 mm; 23,0 cm	258
118 91 0186	Kocher hák na rány; 60×20 mm; 23,0 cm	Kocher retractor; 60×20 mm; 23,0 cm	258
118 91 0187	Kocher hák na rány; 60×25 mm; 23,0 cm	Kocher retractor; 60×25 mm; 23,0 cm	258
118 91 0188	Kocher hák na rány; 75×30 mm; 23,0 cm	Kocher retractor; 75×30 mm; 23,0 cm	258
118 91 0189	Kocher hák na rány; 75×40 mm; 23,0 cm	Kocher retractor; 75×40 mm; 23,0 cm	258
118 91 0197	Brunner hák na rány; 80×20 mm; 25,0 cm	Brunner retractor; 80×20 mm; 25,0 cm	259
118 91 0198	Brunner hák na rány; 100×20 mm; 25,0 cm	Brunner retractor; 100×20 mm; 25,0 cm	259
118 91 0199	Brunner hák na rány; 120×25 mm; 25,0 cm	Brunner retractor; 120×25 mm; 25,0 cm	259
118 91 0200	Brunner hák na rány; 140×25 mm; 25,0 cm	Brunner retractor; 140×25 mm; 25,0 cm	259
118 91 0201	Brunner hák na rány; 160×30 mm; 25,0 cm	Brunner retractor; 160×30 mm; 25,0 cm	259
118 91 0202	Brunner hák na rány; 180×30 mm; 25,0 cm	Brunner retractor; 180×30 mm; 25,0 cm	259
118 91 0208	Middeldorpf hák na rány; 14×17 mm; 21,5 cm	Middeldorpf retractor; 14×17 mm; 21,5 cm	260
118 91 0209	Middeldorpf hák na rány; 20×22 mm; 22,0 cm	Middeldorpf retractor; 20×22 mm; 22,0 cm	260
118 91 0210	Middeldorpf hák na rány; 26×30 mm; 23,5 cm	Middeldorpf retractor; 26×30 mm; 23,5 cm	260
118 91 0211	Richardson hák na rány; 28×20 mm; 24,0 cm	Richardson retractor; 28×20 mm; 24,0 cm	260
118 91 0212	Richardson hák na rány; 36×28 mm; 24,0 cm	Richardson retractor; 36×28 mm; 24,0 cm	260
118 91 0213	Richardson hák na rány; 44×38 mm; 24,0 cm	Richardson retractor; 44×38 mm; 24,0 cm	260
118 91 0214	Richardson hák na rány; 52×22 mm; 24,0 cm	Richardson retractor; 52×22 mm; 24,0 cm	260
118 91 0215	Richardson hák na rány; 65×50 mm; 24,0 cm	Richardson retractor; 65×50 mm; 24,0 cm	260
118 91 0216	Richardson-Eastman hák na rány fig.1+2	Richardson-Eastman retractor fig.1+2	261
118 91 0217	Richardson-Eastman hák na rány fig.1; 26,0 cm	Richardson-Eastman retractor fig.1; 26,0 cm	261
118 91 0218	Richardson-Eastman hák na rány fig.2; 28,0 cm	Richardson-Eastman retractor fig.2; 28,0 cm	261
118 91 0225	Fritsch hák břišní; 45×40 mm; 24,0 cm	Fritsch retractor; 45×40 mm; 24,0 cm	263
118 91 0226	Fritsch hák břišní; 45×50 mm; 24,0 cm	Fritsch retractor; 45×50 mm; 24,0 cm	263
118 91 0227	Fritsch hák břišní; 45×60 mm; 24,0 cm	Fritsch retractor; 45×60 mm; 24,0 cm	263
118 91 0228	Fritsch hák břišní; 45×75 mm; 24,0 cm	Fritsch retractor; 45×75 mm; 24,0 cm	263
118 91 0229	Fritsch hák břišní; 65×85 mm; 24,0 cm	Fritsch retractor; 65×85 mm; 24,0 cm	263
118 91 0230	Kocher hák břišní; 70×25 mm; 22,0 cm	Kocher retractor; 70×25 mm; 22,0 cm	264
118 91 0233	Kocher hák břišní; 80×60 mm; 25,0 cm	Kocher retractor; 80×60 mm; 25,0 cm	264
118 91 0242	Harrington hák břišní; 127×40 mm; 32,0 cm	Harrington retractor; 127×40 mm; 32,0 cm	265
118 91 0243	Harrington hák břišní; 127×62 mm; 32,0 cm	Harrington retractor; 127×62 mm; 32,0 cm	265
118 91 0244	Harrington hák břišní; 175×64 mm; 32,0 cm	Harrington retractor; 175×64 mm; 32,0 cm	265
118 91 0246	Mikulicz hák břišní; 85×35 mm; 26,0 cm	Mikulicz retractor; 85×35 mm; 26,0 cm	265

číslo – number	název	item	strana – page
118 91 0247	Mikulicz hák břišní; 120×50 mm; 26,0 cm	Mikulicz retractor; 120×50 mm; 26,0 cm	265
118 91 0248	Mikulicz hák břišní; 155×50 mm; 26,0 cm	Mikulicz retractor; 155×50 mm; 26,0 cm	265
118 91 0249	Kelly hák břišní; 160×38 mm; 27,0 cm	Kelly retractor; 160×38 mm; 27,0 cm	264
118 91 0250	Kelly hák břišní; 160×57 mm; 27,0 cm	Kelly retractor; 160×57 mm; 27,0 cm	264
118 91 0251	Kelly hák břišní; 190×38 mm; 27,0 cm	Kelly retractor; 190×38 mm; 27,0 cm	264
118 91 0252	Kelly hák břišní; 190×57 mm; 27,0 cm	Kelly retractor; 190×57 mm; 27,0 cm	264
118 91 0253	Deaver hák břišní; 19,0 mm; 18,0 cm	Deaver retractor; 19,0 mm; 18,0 cm	266
118 91 0254	Deaver hák břišní; 22,0 mm; 21,5 cm	Deaver retractor; 22,0 mm; 21,5 cm	266
118 91 0255	Deaver hák břišní; 25,0 mm; 23,0 cm	Deaver retractor; 25,0 mm; 23,0 cm	266
118 91 0256	Deaver hák břišní; 25,0 mm 30,0 cm	Deaver retractor; 25,0 mm; 30,0 cm	266
118 91 0257	Deaver hák břišní; 25,0 mm; 33,0 cm	Deaver retractor; 25,0 mm; 33,0 cm	266
118 91 0258	Deaver hák břišní; 25,0 mm; 36,0 cm	Deaver retractor; 25,0 mm; 36,0 cm	266
118 91 0259	Deaver hák břišní; 38,0 mm; 30,0 cm	Deaver retractor; 38,0 mm; 30,0 cm	267
118 91 0260	Deaver hák břišní; 50,0 mm; 30,0 cm	Deaver retractor; 50,0 mm; 30,0 cm	267
118 91 0261	Deaver hák břišní; 75,0 mm; 30,0 cm	Deaver retractor; 75,0 mm; 30,0 cm	267
118 91 0294	Roux hák sada fig.1-3; 16,5 cm	Roux retractor set fig.1-3; 16,5 cm	275
118 91 0295	Roux hák fig.1	Roux retractor fig.1	275
118 91 0296	Roux hák fig.2	Roux retractor fig.2	275
118 91 0297	Roux hák fig.3	Roux retractor fig.3	275
118 91 0298	Farabeuf hák sada fig.1+2; 12,0 cm	Farabeuf retractor set fig.1+2; 12,0 cm	275
118 91 0299	Farabeuf hák fig.1	Farabeuf retractor fig.1	275
118 91 0300	Farabeuf hák fig.2	Farabeuf retractor fig.2	275
118 91 0301	Farabeuf hák sada fig.1+2; 15,0 cm	Farabeuf retractor set fig.1+2; 15,0 cm	275
118 91 0302	Farabeuf hák fig.1	Farabeuf retractor fig.1	275
118 91 0303	Farabeuf hák fig.2	Farabeuf retractor fig.2	275
118 91 0304	Parker hák sada malá fig.1+2; 13,5 cm	Parker retractor set small fig.1+2; 13,5 cm	275
118 91 0305	Parker hák fig.1	Parker retractor fig.1	275
118 91 0306	Parker hák fig.2	Parker retractor fig.2	275
118 91 0307	Parker hák sada velká fig.1+2; 18,0 cm	Parker retractor set large fig.1+2; 18,0 cm	276
118 91 0308	Parker hák fig.1	Parker retractor fig.1	276
118 91 0309	Parker hák fig.2	Parker retractor fig.2	276
118 91 0310	Mathieu hák sada fig.1+2; 20,0 cm	Mathieu retractor set fig.1+2; 20,0 cm	276
118 91 0311	Mathieu hák fig.1	Mathieu retractor fig.1	276
118 91 0312	Mathieu hák fig.2	Mathieu retractor fig.2	276
118 91 0313	Parker-Langenbeck hák sada fig.1+2; 21,0 cm	Parker-Langenbeck retractor set fig.1+2; 21,0 cm	276
118 91 0314	Parker-Langenbeck hák fig.1	Parker-Langenbeck retractor fig.1	276
118 91 0315	Parker-Langenbeck hák fig.2	Parker-Langenbeck retractor fig.2	276
118 91 0316	Goelet hák; 19,0 cm	Goelet retractor; 19,0 cm	276
118 91 0396	Blount hák na meniskus; 17,5 cm	Blount meniscus hook; 17,5 cm	273
118 91 0409	Young hák na prostatu; 11×50 mm; 21 cm	Young retractor for prostate; 11×50 mm; 21 cm	270
118 91 0410	Young hák na prostatu; 38×64 mm; 22 cm	Young retractor for prostate; 38×64 mm; 22 cm	270
118 91 0411	Young hák na prostatu; 25×25 mm; 21 cm	Young retractor for prostate; 25×25 mm; 21 cm	270
118 91 0412	Young hák na prostatu; 39×35 mm; 22 cm	Young retractor for prostate; 39×35 mm; 22 cm	271
119	ROZVĚRAČE	RETRACTORS	
119 07 0010	Roser-König rozvěrač úst; 19,5 cm	Roser-König mouth retractor; 19,5 cm	280
119 07 0020	Heister rozvěrač úst; 13,0 cm	Heister mouth retractor; 13,0 cm	280
119 08 0100	Weitlaner rozvěrač ran ostrý; 3×4 zuby; 13,0 cm	Weitlaner retractor 3×4 teeth sharp; 13,0 cm	281
119 08 0110	Weitlaner rozvěrač ran tupý; 3×4 zuby; 13,0 cm	Weitlaner retractor 3×4 teeth blunt; 13,0 cm	281
119 08 0240	Rozvěrač ran ostrý; 4×5 zubů; 18,0 cm	Retractor 4×5 teeth sharp; 18,0 cm	280
119 08 0250	Gosset rozvěrač břišní posuvný; 22,0 cm	Gosset abdominal retractor; 22,0 cm	293
119 08 0260	Collin rozvěrač ran posuv. se 3 páry vým. lopatek; 22,0 cm	Collin retractor - set; 22,0 cm	293
119 08 0610	Walton rozvěrač ran páteřní s hrotem pravý; 19,5 cm	Walton retractor right; 19,5 cm	286
119 08 0620	Walton rozvěrač ran páteřní s hrotem levý; 19,5 cm	Walton retractor left; 19,5 cm	286
119 08 0650	Adson rozvěrač ran ostrý; 3×4 zuby; 24,0 cm	Adson retractor 3×4 teeth sharp; 24,0 cm	286
119 08 0670	Rigby rozvěrač ran s plnými lopatkami; 18,5 cm	Rigby retractor; 18,5 cm	285
119 08 0680	Weitlaner rozvěrač ran ostrý; 4×3 zuby; 16,5 cm	Weitlaner retractor 4×3 teeth sharp; 16,5 cm	281
119 08 0690	Weitlaner rozvěrač ran tupý; 4×3 zuby; 16,5 cm	Weitlaner retractor 4×3 teeth blunt; 16,5 cm	281
119 08 0870	Rozvěrač ran s lomen. rameny ostrý fig.1; 5×5 zubů; 30,0 cm	Retractor 5×5 teeth sharp fig.1; 30,0 cm	281
119 08 1040	Weitlaner rozvěrač ran ostrý; 3×4 zuby; 13,5 cm	Weitlaner retractor 3×4 teeth sharp; 13,5 cm	281
119 08 1060	Weitlaner rozvěrač ran tupý; 3×4 zuby; 13,5 cm	Weitlaner retractor 3×4 teeth blunt; 13,5 cm	281
119 08 1080	Rozvěrač ran s lomen. rameny ostrý; 3×3 zuby; 13,0 cm	Retractor 3×3 teeth sharp; 13,0 cm	286
119 08 1090	Rozvěrač ran s lomen. rameny tupý; 3×3 zuby; 13,0 cm	Retractor 3×3 teeth blunt; 13,0 cm	286
119 08 1100	Rozvěrač ran s lomen. rameny ostrý; 2×2 zuby; 13,0 cm	Retractor 2×2 teeth sharp; 13,0 cm	286
119 08 1110	Rozvěrač ran s lomen. rameny tupý; 2×2 zuby; 13,0 cm	Retractor 2×2 teeth blunt; 13,0 cm	286
119 08 1120	Rozvěrač ran s lomen. rameny tupý; 3×4 zuby; 14,5 cm	Retractor 3×4 teeth blunt; 14,5 cm	286
119 08 1140	Rozvěrač ran ostrý; 3×4 zuby; 21 mm; 13,5 cm	Retractor 3×4 teeth sharp; 21 mm; 13,5 cm	286
119 08 1150	Rozvěrač ran tupý; 3×4 zuby; 21 mm; 13,5 cm	Retractor 3×4 teeth blunt; 21 mm; 13,5 cm	286
119 08 1170	Rozvěrač ran lopatkový; 2×2 zuby; 17,5 cm	Retractor 2×2 teeth; 17,5 cm	285
119 08 1280	Klíč k rámovému rozvěrač	Key for holder frame	296
119 08 1300	Rám drážkový; 260×255 mm	Holder frame; 260×255 mm	296
119 08 1310	Rám drážkový; 330×320 mm	Holder frame; 330×320 mm	296

číslo – number	název	item	strana – page
119 08 1320	Držák háku	Hook holder	296
119 08 1350	Držadlo háku	Hook handle	296
119 08 1400	Hák; 75×65 mm	Hook; 75×65 mm	296
119 08 1410	Hák; 100×65 mm	Hook; 100×65 mm	296
119 10 0100	Rozvěrač víček kojenecký; 4,3 cm	Lid retractor for infants; 4,3 cm	280
119 14 0020	Chandler rozvěrač hrudní; 23,2 cm	Chandler pectoral retractor; 23,2 cm	287
119 14 0050	Finochietto rozvěrač hrudní; 21,5 cm	Finochietto pectoral retractor; 21,5 cm	287
119 17 0030	Rozvěrač pro laminekotimii ostrý; 7×7 zubů; 32,2 cm	Laminectomy retractor 7×7 teeth sharp; 32,2 cm	291
119 17 0050	Rozvěrač pro laminekotimii ostrý; 4×4 zubů; 32,2 cm	Laminectomy retractor 4×4 teeth sharp; 32,2 cm	291
119 17 0060	Rozvěrač pro laminekotimii tupý; 4×4 zubů; 32,2 cm	Laminectomy retractor 4×4 teeth blunt; 32,2 cm	291
119 38 0050	Weber rozvěrač víček pravý nemagnetický; 8,0 cm	Weber lid retractor; 8,0 cm	280
119 38 0060	Weber rozvěrač víček levý nemagnetický; 8,0 cm	Weber lid retractor; 8,0 cm	280
119 38 0070	Rozvěrač víček mikro; 4,6 cm	Lid retractor micro; 4,6 cm	280
119 38 0400	Müller rozvěrač ran oční; 7,0 cm	Müller eye retractor; 7,0 cm	279
119 91 0001	Finsen rozvěrač ostrý; 2×3 zuby; 5,0 cm	Finsen retractor sharp 2×3 prongs; 5,0 cm	279
119 91 0002	Finsen rozvěrač ostrý; 3×4 zuby; 7,0 cm	Finsen retractor sharp 3×4 prongs; 7,0 cm	279
119 91 0003	Finsen rozvěrač tupý; 2×3 zuby; 5,0 cm	Finsen retractor blunt 2×3 prongs; 5,0 cm	279
119 91 0004	Finsen rozvěrač tupý; 3×4 zuby; 7,0 cm	Finsen retractor blunt 3×4 prongs; 7,0 cm	279
119 91 0005	Rozvěrač ostrý; 4×4 zuby; 10,0 cm	Retractor sharp; 4×4 teeth; 10,0 cm	279
119 91 0006	Rozvěrač tupý; 4×4 zuby; 10,0 cm	Retractor blunt; 4×4 teeth; 10,0 cm	279
119 91 0007	Alm rozvěrač ostrý; 4×4 zuby; 7,0 cm	Alm retractor sharp 4×4 prongs; 7,0 cm	279
119 91 0008	Alm rozvěrač ostrý; 4×4 zuby; 10,0 cm	Alm retractor sharp 4×4 prongs; 10,0 cm	279
119 91 0009	Alm rozvěrač tupý; 4×4 zuby; 7,0 cm	Alm retractor blunt 4×4 prongs; 7,0 cm	279
119 91 0010	Alm rozvěrač tupý; 4×4 zuby; 10,0 cm	Alm retractor blunt 4×4 prongs; 10,0 cm	279
119 91 0013	Jansen rozvěrač ostrý; 4×4 zuby; 10,0 cm	Jansen retractor sharp 4×4 prongs; 10,0 cm	279
119 91 0014	Jansen rozvěrač tupý; 4×4 zuby; 10,0 cm	Jansen retractor blunt 4×4 prongs; 10,0 cm	279
119 91 0020	Weitlaner rozvěrač ostrý; 2×3 zuby; 10,5 cm	Weitlaner retractor sharp; 2×3 teeth; 10,5 cm	281
119 91 0021	Weitlaner rozvěrač tupý; 2×3 zuby; 10,5 cm	Weitlaner retractor blunt; 2×3 teeth; 10,5 cm	281
119 91 0026	Weitlaner rozvěrač ostrý; 3×4 zuby; 20,0 cm	Weitlaner retractor sharp; 3×4 teeth; 20,0 cm	281
119 91 0027	Weitlaner rozvěrač tupý; 3×4 zuby; 20,0 cm	Weitlaner retractor blunt; 3×4 teeth; 20,0 cm	281
119 91 0028	Weitlaner rozvěrač ostrý; 3×4 zuby; 25,0 cm	Weitlaner retractor sharp; 3×4 teeth; 25,0 cm	281
119 91 0029	Weitlaner rozvěrač tupý; 3×4 zuby; 25,0 cm	Weitlaner retractor blunt; 3×4 teeth; 25,0 cm	281
119 91 0030	Weitlaner rozvěrač ostrý; 5×6 zubů; 26,0 cm	Weitlaner retractor sharp; 5×6 teeth; 26,0 cm	281
119 91 0031	Weitlaner rozvěrač tupý; 5×6 zubů; 26,0 cm	Weitlaner retractor blunt; 5×6 teeth; 26,0 cm	281
119 91 0032	Henley rozvěrač ostrý; 3×4 zuby; 16,5 cm	Henley retractor sharp; 3×4 teeth; 16,5 cm	281
119 91 0033	Henley vyměnitelná lopatka; 16×19 mm	Henley exchangeable blade; 16×19 mm	281
119 91 0034	Henley vyměnitelná lopatka; 16×25 mm	Henley exchangeable blade; 16×25 mm	281
119 91 0035	Henley vyměnitelná lopatka; 16×32 mm	Henley exchangeable blades; 16×32 mm	281
119 91 0036	Henley rozvěrač tupý; 3×4 zuby; 16,5 cm	Henley retractor blunt; 3×4 teeth; 16,5 cm	281
119 91 0042	Wullstein rozvěrač ostrý; 3×3 zuby; 10,5 cm	Wullstein retractor sharp; 3×3 teeth; 10,5 cm	282
119 91 0043	Wullstein rozvěrač ostrý; 3×3 zuby; 13,0 cm	Wullstein retractor sharp; 3×3 teeth; 13,0 cm	282
119 91 0044	Wullstein rozvěrač ostrý; 3×3 zuby; 16,0 cm	Wullstein retractor sharp; 3×3 teeth; 16,0 cm	282
119 91 0045	Wullstein rozvěrač tupý; 3×3 zuby; 10,5 cm	Wullstein retractor blunt; 3×3 teeth; 10,5 cm	282
119 91 0046	Wullstein rozvěrač tupý; 3×3 zuby; 13,0 cm	Wullstein retractor blunt; 3×3 teeth; 13,0 cm	282
119 91 0047	Wullstein rozvěrač tupý; 3×3 zuby; 16,0 cm	Wullstein retractor blunt; 3×3 teeth; 16,0 cm	282
119 91 0048	Mollison rozvěrač ostrý; 4×4 zuby; 15,0 cm	Mollison retractor sharp; 4×4 teeth; 15,0 cm	282
119 91 0049	Mollison rozvěrač tupý; 4×4 zuby; 15,0 cm	Mollison retractor blunt; 4×4 teeth; 15,0 cm	282
119 91 0050	Miskimon rozvěrač ostrý; 7×7 zubů; 22,0 cm	Miskimon retractor sharp; 7×7 teeth; 22,0 cm	282
119 91 0051	Miskimon rozvěrač tupý; 7×7 zubů; 22,0 cm	Miskimon retractor blunt; 7×7 teeth; 22,0 cm	282
119 91 0052	Adson rozvěrač ostrý; 4×4 zuby; 20,0 cm	Adson retractor sharp; 4×4 teeth; 20,0 cm	282
119 91 0053	Adson rozvěrač tupý; 4×4 zuby; 20,0 cm	Adson retractor blunt; 4×4 teeth; 20,0 cm	282
119 91 0054	Anderson-Adson rozvěrač ostrý; 4×4 zuby; 20,0 cm	Anderson-Adson retractor sharp; 4×4 teeth; 20,0 cm	282
119 91 0055	Anderson-Adson rozvěrač tupý; 4×4 zuby; 20,0 cm	Anderson-Adson retractor blunt; 4×4 teeth; 20,0 cm	282
119 91 0062	Cone rozvěrač ostrý; 3×4 zuby; 16,5 cm	Cone retractor sharp; 3×4 teeth; 16,5 cm	283
119 91 0066	Cone rozvěrač tupý; 3×4 zuby; 16,5 cm	Cone retractor blunt; 3×4 teeth; 16,5 cm	283
119 91 0069	Beckmann rozvěrač ostrý; 4×4 zuby; 31,0 cm	Beckmann retractor sharp 4×4 prongs; 31,0 cm	283
119 91 0070	Beckmann rozvěrač tupý; 4×4 zuby; 31,0 cm	Beckmann retractor blunt 4×4 prongs; 31,0 cm	283
119 91 0081	Beckmann-Eaton rozvěrač ostrý; 33,0 cm	Beckmann-Eaton retractor sharp; 33,0 cm	283
119 91 0082	Beckmann-Eaton rozvěrač tupý; 33,0 cm	Beckmann-Eaton retractor blunt; 33,0 cm	283
119 91 0085	Gelpi rozvěrač; 9,0 cm	Gelpi retractor; 9,0 cm	284
119 91 0086	Gelpi rozvěrač; 11,0 cm	Gelpi retractor; 11,0 cm	284
119 91 0087	Gelpi rozvěrač; 14,0 cm	Gelpi retractor; 14,0 cm	284
119 91 0088	Gelpi rozvěrač; 19,0 cm	Gelpi retractor; 19,0 cm	284
119 91 0089	Gelpi rozvěrač; 19,0 cm	Gelpi retractor; 19,0 cm	284
119 91 0094	Markham-Meyerding rozvěrač fig.1; 18,0 cm	Markham-Meyerding retractor fig.1; 18,0 cm	284
119 91 0095	Markham-Meyerding rozvěrač fig.2; 18,0 cm	Markham-Meyerding retractor fig.2; 18,0 cm	284
119 91 0099	Darling rozvěrač fig.1; 18,0 cm	Darling retractor fig.1; 18,0 cm	284
119 91 0100	Darling rozvěrač fig.2; 18,0 cm	Darling retractor fig.2; 18,0 cm	284
119 91 0103	Plester rozvěrač pravý; 10,0 cm	Plester retractor; 10,0 cm	285
119 91 0104	Plester rozvěrač pravý; 13,0 cm	Plester retractor; 13,0 cm	285
119 91 0105	Plester rozvěrač levý; 10,0 cm	Plester retractor; 10,0 cm	285

číslo – number	název	item	strana – page
119 91 0106	Plester rozvěrač levý; 13,0 cm	Plester retractor; 13,0 cm	285
119 91 0110	Mayo-Adams rozvěrač; 17,0 cm	Mayo-Adams retractor; 17,0 cm	285
119 91 0111	Mayo-Adams rozvěrač; 17,0 cm	Mayo-Adams retractor; 17,0 cm	285
119 91 0118	Gosset rozvěrač břišní; 14,0 cm	Gosset abdominal retractor; 14,0 cm	292
119 91 0119	Gosset rozvěrač břišní; 16,0 cm	Gosset abdominal retractor; 16,0 cm	292
119 91 0123	Balfour-Baby rozvěrač břišní; 9,0 cm	Balfour-Baby abdom.retractor; 9,0 cm	294
119 91 0124	Balfour rozvěrač břišní; 18,0 cm	Balfour abdominal retractor; 18,0 cm	294
119 91 0125	Balfour rozvěrač břišní; 20,0 cm	Balfour abdominal retractor; 20,0 cm	294
119 91 0126	Balfour rozvěrač břišní; 25,0 cm	Balfour abdominal retractor; 25,0 cm	294
119 91 0130	Dennis-Browne rozvěrač břišní komplet	Dennis-Browne abdominal retractor complete	295
119 91 0131	Dennis-Browne rám; 190×160 mm	Dennis-Browne frame; 190×160 mm	295
119 91 0132	Dennis-Browne lopatka; 40×30 mm	Dennis-Browne blade; 40×30 mm	295
119 91 0133	Dennis-Browne lopatka; 40×40 mm	Dennis-Browne blade; 40×40 mm	295
119 91 0134	O'Sullivan-O'Connor rám břišní komplet	O'Sullivan-O'Connor abdomin.retractor complete	296
119 91 0135	O'Sullivan-O'Connor rám břišní	O'Sullivan-O'Connor frame	296
119 91 0136	O'Sullivan-O'Connor lopatka; 110×70 mm	O'Sullivan-O'Connor blade; 110×70 mm	296
119 91 0137	O'Sullivan-O'Connor lopatka; 80×45 mm	O'Sullivan-O'Connor blade; 80×45 mm	296
119 91 0142	Franz rám břišní komplet	Franz abdominal retractor complete	297
119 91 0143	Franz rám břišní; 300×300 mm	Franz frame; 300×300 mm	297
119 91 0144	Franz lopatka; 38×60 mm	Franz retractor; 38×60 mm	297
119 91 0145	Franz lopatka; 50×65 mm	Franz retractor; 50×65 mm	297
119 91 0146	Franz rám břišní komplet	Franz abdominal retractor complete	297
119 91 0147	Franz lopatka; 45×80 mm	Franz retractor; 45×80 mm	297
119 91 0148	Franz lopatka; 60×85 mm	Franz retractor; 60×85 mm	297
119 91 0149	Franz lopatka; 105×35 mm	Franz retractor; 105×35 mm	297
119 91 0150	Franz lopatka; 98×50 mm	Franz retractor; 98×50 mm	297
119 91 0151	Kirschner rám břišní komplet	Kirschner abdominal retractor complete	298
119 91 0152	Kirschner rozvěrač břišní rámový	Kirschner abdominal retractor frame	298
119 91 0153	Kirschner lopatka; 40×55 mm	Kirschner retractor; 40×55 mm	298
119 91 0154	Kirschner lopatka; 50×65 mm	Kirschner retractor; 50×65 mm	298
119 91 0155	Kirschner lopatka; 78×65 mm	Kirschner retractor; 78×65 mm	298
119 91 0156	Kirschner lopatka; 80×90 mm	Kirschner retractor; 80×90 mm	298
119 91 0157	Semm rozvěrač břišní komplet	Semm abdominal retractor complete	295
119 91 0158	Semm rám; 275×250 mm	Semm frame; 275×250 mm	295
119 91 0159	Semm lopatka; 47×65 mm	Semm blade; 47×65 mm	295
119 91 0160	Semm lopatka; 50×54 mm	Semm blade; 50×54 mm	295
119 91 0161	Semm lopatka; 76×98 mm	Semm blade; 76×98 mm	295
119 91 0162	Semm lopatka; 98×52 mm	Semm blade; 98×52 mm	295
119 91 0163	Semm lopatka; 105×35 mm	Semm blade; 105×35 mm	295
119 91 0164	Collin-Baby rozvěrač břišní komplet	Collin-Baby abdominal retractor complete	300
119 91 0165	Lopatka; 23×44 mm	Blade; 23×44 mm	300
119 91 0166	Lopatka; 30×44 mm	Blade; 30×44 mm	300
119 91 0169	Collin rozvěrač břišní; 22,0 cm	Collin abdominal retractor; 22,0 cm	300
119 91 0170	Collin rozvěrač břišní; 22,0 cm	Collin abdominal retractor; 22,0 cm	300
119 91 0173	Ricard rozvěrač břišní; 28,0 cm	Ricard abdominal retractor; 28,0 cm	301
119 91 0174	Ricard rozvěrač břišní; 30,0 cm	Ricard abdominal retractor; 30,0 cm	301
119 91 0184	Percy talíř amputační	Percy amputation shield	302
119 91 0244	Finnocchieto-Baby rozvěrač břišní; 7,5 cm	Finnocchieto-Baby rip spreader; 7,5 cm	288
119 91 0245	Finnocchieto rozvěrač břišní; 15,0 cm	Finnocchieto rip spreader; 15,0 cm	288
119 91 0246	Finnocchieto rozvěrač břišní; 19,0 cm	Finnocchieto rip spreader; 19,0 cm	288
119 91 0247	Finnocchieto rozvěrač břišní; 19,0 cm	Finnocchieto rip spreader; 19,0 cm	288
119 91 0280	Rozvěrač břišní řetízkový; 20,0 cm	Chain abdominal retractor; 20,0 cm	301
119 91 0281	Rozvěrač břišní řetízkový; 20,0 cm	Chain abdominal retractor; 20,0 cm	301
119 91 0282	Rozvěrač břišní řetízkový; 20,0 cm	Chain abdominal retractor; 20,0 cm	301
119 91 0283	Rochard rozvěrač břišní	Rochard abdominal retractor	298
119 91 0494	Rozvěrač břišní na operaci jater	Abdominal retractor for liver operation	299
119 99 0026	Gotfrýd rozvěrač páteřní; 16,5 cm	Gotfrýd spinal retractor; 16,5 cm	289
119 99 0028	Lopatka k rozvěrači páteřnímu; 42×20 mm	Blade of spinal retractor; 42×20 mm	289
119 99 0029	Lopatka k rozvěrači páteřnímu; 52×20 mm	Blade of spinal retractor; 52×20 mm	289
119 99 0030	Lopatka k rozvěrači páteřnímu jednozubá ostrá; 32×7 mm	Blade of spinal retractor; 32×7 mm	289
119 99 0110	Finochietto rozvěrač páteřní	Finochietto spinal retractor	290
119 99 0111	Finochietto lopatka rozvěrače páteřního; 10×30 mm	Finochietto blade of spinal retractor; 10×30 mm	290
119 99 0112	Finochietto lopatka rozvěrače páteřního; 10×45 mm	Finochietto blade of spinal retractor; 10×45 mm	290
119 99 0113	Finochietto lopatka rozvěrače páteřního; 10×60 mm	Finochietto blade of spinal retractor; 10×60 mm	290
119 99 0114	Finochietto lopatka rozvěrače páteřního; 10×75 mm	Finochietto blade of spinal retractor; 10×75 mm	290
119 99 0115	Finochietto lopatka rozvěrače páteřního; 10×90 mm	Finochietto blade of spinal retractor; 10×90 mm	290
121	LOPATKY	SPATULAS	
121 08 0050	Lopatka břišní ohebná; 33,0×4,0 cm	Abdominal spatula malleable; 33,0×4,0 cm	305
121 08 0100	Lopatka na masť s výřezem; 13×16 mm; 14,0 cm	Unguent spatula; 13×16 mm; 14,0 cm	305
121 12 0020	Nástroj na vyhlazení čela fig.1; 25,2 cm	Lifting instrument fig.1; 25,2 cm	306
121 12 0030	Nástroj na vyhlazení čela fig.2; 25,2 cm	Lifting instrument fig.2; 25,2 cm	306

číslo – number	název	item	strana – page
121 12 0040	Nástroj na vyhlazení čela fig.3; 25,2 cm	Lifting instrument fig.3; 25,2 cm	306
121 12 0050	Nástroj na vyhlazení čela fig.4; 25,2 cm	Lifting instrument fig.4; 25,2 cm	306
121 12 0060	Nástroj na vyhlazení čela fig.5; 25,2 cm	Lifting instrument fig.5; 25,2 cm	306
121 12 0070	Nástroj na vyhlazení čela fig.6; 25,2 cm	Lifting instrument fig.6; 25,2 cm	306
121 12 0080	Nástroj na vyhlazení čela fig.7; 25,2 cm	Lifting instrument fig.7; 25,2 cm	306
121 17 0040	Lopatka mozková ohebná; 10×8 mm; 19,0 cm	Brain spatula malleable; 10×8 mm; 19,0 cm	307
121 17 0050	Lopatka mozková ohebná; 14×12 mm; 19,0 cm	Brain spatula malleable; 14×12 mm; 19,0 cm	307
121 17 0060	Lopatka mozková ohebná; 16×14 mm; 19,0 cm	Brain spatula malleable; 16×14 mm; 19,0 cm	307
121 17 0070	Lopatka mozková ohebná; 21×16 mm; 19,0 cm	Brain spatula malleable; 21×16 mm; 19,0 cm	307
121 22 0010	Tuffier lopatka na ledviny ohebná; 16×23 mm; 17,5 cm	Tuffier kidney spatula malleable; 16×23 mm; 17,5 cm	307
121 31 0010	Buchwald lopatka na jazyk; 16×23 mm; 17,3 cm	Buchwald tongue spatula; 16×23 mm; 17,3 cm	307
121 31 0020	Brünnings lopatka na jazyk; 14×18 mm; 19,5 cm	Brünnings tongue spatula; 14×18 mm; 19,5 cm	307
121 38 0010	Jaeger destička na víčkové operace; 19×19 mm; 10,7 cm	Jaeger eye lid plate; 19×19 mm; 10,7 cm	307
121 38 0020	Pagenstecher lopatka na hmotu čočky; 14,5 cm	Pagenstecher lens spatula; 14,5 cm	308
121 38 0110	Lopatka na duhovku zahnutá fig.1; 13,5 cm	Iris spatula curved fig.1; 13,5 cm	308
121 38 0120	Lopatka na duhovku zahnutá fig.2; 13,5 cm	Iris spatula curved fig.2; 13,5 cm	308
121 38 0210	Weber klička oční; 14,0 cm	Weber wire loop; 14,0 cm	308
121 91 0012	Reverdin lopatka břišní; 45×60 mm; 29,0 cm	Reverdin abdominal spatula; 45×60 mm; 29,0 cm	305
121 91 0027	Allison lopatka na plíce; 26,0 cm	Allison lung spatula; 26,0 cm	305
121 91 0028	Allison lopatka na plíce; 32,0 cm	Allison lung spatula; 32,0 cm	305
122	ZRCADLA	SPECULA	
122 27 0350	Páka poševní postránní zahnutá; 45°; 20 mm; 23,8 cm	Vaginal elevator; 45°; 20 mm; 23,8 cm	311
122 27 0370	Páka poševní postránní zahnutá; 45°; 30 mm; 24,0 cm	Vaginal elevator; 45°; 30 mm; 24,0 cm	311
122 27 0380	Páka poševní postránní zahnutá; 45°; 35 mm; 23,5 cm	Vaginal elevator; 45°; 35 mm; 23,5 cm	311
122 27 0400	Páka poševní postránní zahnutá; 45°; 45 mm; 23,5 cm	Vaginal elevator; 45°; 45 mm; 23,5 cm	311
122 27 0420	Páka poševní postránní zahnutá; 90°; 20 mm; 16,9 cm	Vaginal elevator; 90°; 20 mm; 16,9 cm	311
122 27 0440	Páka poševní postránní zahnutá; 90°; 30 mm; 16,9 cm	Vaginal elevator; 90°; 30 mm; 16,9 cm	311
122 27 0450	Páka poševní postránní zahnutá; 90°; 35 mm; 16,9 cm	Vaginal elevator; 90°; 35 mm; 16,9 cm	312
122 27 0470	Páka poševní postránní zahnutá; 90°; 45 mm; 16,9 cm	Vaginal elevator; 90°; 45 mm; 16,9 cm	312
122 27 0490	Kristeller zrcadlo poševní sada; 115×28 mm; 115×32 mm	Kristeller vaginal specula set; 115×28 mm; 115×32 mm	312
122 30 0010	Hartmann zrcátko nosní fig.1; 6,0 mm	Hartmann nasal speculum fig.1; 6,0 mm	317
122 30 0020	Hartmann zrcátko nosní fig.2; 7,5 mm	Hartmann nasal speculum fig.2; 7,5 mm	317
122 30 0100	Killian zrcátko nosní fig.1; 42 mm	Killian nasal speculum fig.1; 42 mm	317
122 30 0110	Killian zrcátko nosní fig.2; 54 mm	Killian nasal speculum fig.2; 54 mm	317
122 30 0120	Killian zrcátko nosní fig.3; 75 mm	Killian nasal speculum fig.3; 75 mm	317
122 91 0001	Cusco zrcadlo poševní; 75×32 mm	Cusco vaginal speculum; 75×32 mm	314
122 91 0002	Cusco zrcadlo poševní; 85×35 mm	Cusco vaginal speculum; 85×35 mm	314
122 91 0003	Cusco zrcadlo poševní; 100×35 mm	Cusco vaginal speculum; 100×35 mm	314
122 91 0004	Cusco-virgin zrcadlo poševní; 75×17 mm	Cusco-Virgin vaginal speculum; 75×17 mm	314
122 91 0005	Cusco-suisse zrcadlo poševní; 80×22 mm	Cusco-Suisse vaginal speculum; 80×22 mm	314
122 91 0006	Cusco-suisse zrcadlo poševní; 100×25 mm	Cusco-Suisse vaginal speculum; 100×25 mm	314
122 91 0007	Cusco-suisse zrcadlo poševní; 105×27 mm	Cusco-Suisse vaginal speculum; 105×27 mm	314
122 91 0008	Cusco zrcadlo poševní; 74×32 mm	Cusco vaginal speculum; 74×32 mm	314
122 91 0009	Cusco zrcadlo poševní; 85×35 mm	Cusco vaginal speculum; 85×35 mm	314
122 91 0010	Cusco zrcadlo poševní; 100×37 mm	Cusco vaginal speculum; 100×37 mm	314
122 91 0094	Kristeller zrcadlo poševní fig.1; 70×27 mm	Kristeller vaginal speculum fig.1; 70×27 mm	313
122 91 0095	Kristeller zrcadlo poševní fig.2; 80×30 mm	Kristeller vaginal speculum fig.2; 80×30 mm	313
122 91 0096	Kristeller zrcadlo poševní fig.3; 90×36 mm	Kristeller vaginal speculum fig.3; 90×36 mm	313
122 91 0097	Kristeller zrcadlo poševní fig.1; 75×23 mm	Kristeller vaginal speculum fig.1; 75×23 mm	313
122 91 0098	Kristeller zrcadlo poševní fig.2; 85×26 mm	Kristeller vaginal speculum fig.2; 85×26 mm	313
122 91 0099	Kristeller zrcadlo poševní fig.3; 100×32 mm	Kristeller vaginal speculum fig.3; 100×32 mm	313
122 91 0100	Kristeller zrcadlo poševní sada fig.1	Kristeller vaginal specula set fig.1	313
122 91 0101	Kristeller zrcadlo poševní sada fig.2	Kristeller vaginal specula set fig.2	313
122 91 0102	Kristeller zrcadlo poševní sada fig.3	Kristeller vaginal specula set fig.3	313
122 91 0103	Kristeller zrcadlo poševní fig.00; 105×18 mm	Kristeller vaginal speculum fig.00; 105×18 mm	313
122 91 0104	Kristeller zrcadlo poševní fig.0; 105×21 mm	Kristeller vaginal speculum fig.0; 105×21 mm	313
122 91 0105	Kristeller zrcadlo poševní fig.00; 110×14 mm	Kristeller vaginal speculum fig.00; 110×14 mm	313
122 91 0106	Kristeller zrcadlo poševní fig.0; 110×17 mm	Kristeller vaginal speculum fig.0; 110×17 mm	313
122 91 0107	Kristeller zrcadlo poševní sada fig.00	Kristeller vaginal specula set fig.00	313
122 91 0108	Kristeller zrcadlo poševní sada fig.0	Kristeller vaginal specula set fig.0	313
122 91 0109	Kristeller zrcadlo poševní fig.1; 105×26 mm	Kristeller vaginal speculum fig.1; 105×26 mm	313
122 91 0110	Kristeller zrcadlo poševní fig.2; 105×28 mm	Kristeller vaginal speculum fig.2; 105×28 mm	313
122 91 0111	Kristeller zrcadlo poševní fig.3; 105×33 mm	Kristeller vaginal speculum fig.3; 105×33 mm	313
122 91 0112	Kristeller zrcadlo poševní fig.1; 115×22 mm	Kristeller vaginal speculum fig.1; 115×22 mm	313
122 91 0113	Kristeller zrcadlo poševní fig.2; 115×24 mm	Kristeller vaginal speculum fig.2; 115×24 mm	313
122 91 0114	Kristeller zrcadlo poševní fig.3; 115×29 mm	Kristeller vaginal speculum fig.3; 115×29 mm	313
122 91 0115	Kristeller zrcadlo poševní sada fig.1	Kristeller vaginal specula set fig.1	313
122 91 0116	Kristeller zrcadlo poševní sada fig.2	Kristeller vaginal specula set fig.2	313
122 91 0117	Kristeller zrcadlo poševní sada fig.3	Kristeller vaginal specula set fig.3	313
122 91 0118	Kristeller zrcadlo poševní fig.1; 110×27 mm	Kristeller vaginal speculum fig.1; 110×27 mm	313
122 91 0119	Kristeller zrcadlo poševní fig.2; 110×30 mm	Kristeller vaginal speculum fig.2; 110×30 mm	313

číslo – number	název	item	strana – page
122 91 0120	Kristeller zrcadlo poševní fig.3; 110×36 mm	Kristeller vaginal speculum fig.3; 110×36 mm	313
122 91 0121	Kristeller zrcadlo poševní fig.1; 115×23 mm	Kristeller vaginal speculum fig.1; 115×23 mm	313
122 91 0122	Kristeller zrcadlo poševní fig.2; 115×26 mm	Kristeller vaginal speculum fig.2; 115×26 mm	313
122 91 0123	Kristeller zrcadlo poševní fig.3; 115×32 mm	Kristeller vaginal speculum fig.3; 115×32 mm	313
122 91 0124	Kristeller zrcadlo poševní sada fig.1	Kristeller vaginal specula set fig.1	313
122 91 0125	Kristeller zrcadlo poševní sada fig.2	Kristeller vaginal specula set fig.2	313
122 91 0126	Kristeller zrcadlo poševní sada fig.3	Kristeller vaginal specula set fig.3	313
122 91 0127	Doyen zrcadlo poševní; 55×35 mm	Doyen vaginal speculum sl. concave; 55×35 mm	315
122 91 0128	Doyen zrcadlo poševní; 85×35 mm	Doyen vaginal speculum sl. concave; 85×35 mm	315
122 91 0129	Doyen zrcadlo poševní; 115×35 mm	Doyen vaginal speculum sl. concave; 115×35 mm	315
122 91 0130	Doyen zrcadlo poševní; 55×45 mm	Doyen vaginal speculum sl. concave; 55×45 mm	315
122 91 0131	Doyen zrcadlo poševní; 85×45 mm	Doyen vaginal speculum sl. concave; 85×45 mm	315
122 91 0132	Doyen zrcadlo poševní; 115×45 mm	Doyen vaginal speculum sl. concave; 115×45 mm	315
122 91 0133	Doyen zrcadlo poševní; 55×60 mm	Doyen vaginal speculum sl. concave; 55×60 mm	315
122 91 0134	Doyen zrcadlo poševní; 85×60 mm	Doyen vaginal speculum sl. concave; 85×60 mm	315
122 91 0135	Doyen zrcadlo poševní; 115×60 mm	Doyen vaginal speculum sl. concave; 115×60 mm	315
122 91 0136	Scherback zrcadlo poševní komplet	Scherback vaginal speculum, set complete	315
122 91 0137	Lžice pro zrcadlo Scherback	Blade only for Scherback speculum	315
122 91 0138	Lžice pro zrcadlo Scherback	Blade only for Scherback speculum	315
122 91 0139	Lžice pro zrcadlo Scherback	Blade only for Scherback speculum	315
122 91 0140	Lžice pro zrcadlo Scherback	Blade only for Scherback speculum	315
122 91 0141	Lžice pro zrcadlo Scherback	Blade only for Scherback speculum	315
122 91 0142	Držadlo pro zrcadlo Scherback	Handle only for Scherback speculum	315
122 91 0143	Závaží pro zrcadlo Scherback; 400g	Weight only for Scherback speculum; 400g; 400g	315
122 91 0144	Závaží pro zrcadlo Scherback; 800g	Weight only for Scherback speculum; 800g; 800g	315
122 91 0145	Scherback zrcadlo poševní komplet	Scherback vaginal specula set	315
122 91 0172	Držátko zrcátek hrtanových	Handle for laryngeal mirror	319
122 91 0173	Zrcátko hrtanové fig.00; 8 mm	Laryngeal mirror w/o handle fig.00; 8 mm	319
122 91 0174	Zrcátko hrtanové fig.0; 10 mm	Laryngeal mirror w/o handle fig.0; 10 mm	319
122 91 0175	Zrcátko hrtanové fig.1; 12 mm	Laryngeal mirror w/o handle fig.1; 12 mm	319
122 91 0176	Zrcátko hrtanové fig.2; 14 mm	Laryngeal mirror w/o handle fig.2; 14 mm	319
122 91 0177	Zrcátko hrtanové fig.3; 16 mm	Laryngeal mirror w/o handle fig.3; 16 mm	319
122 91 0178	Zrcátko hrtanové fig.4; 18 mm	Laryngeal mirror w/o handle fig.4; 18 mm	319
122 91 0179	Zrcátko hrtanové fig.5; 20 mm	Laryngeal mirror w/o handle fig.5; 20 mm	319
122 91 0180	Zrcátko hrtanové fig.6; 22 mm	Laryngeal mirror w/o handle fig.6; 22 mm	319
122 91 0181	Zrcátko hrtanové fig.7; 24 mm	Laryngeal mirror w/o handle fig.7; 24 mm	319
122 91 0182	Zrcátko hrtanové fig.8; 26 mm	Laryngeal mirror w/o handle fig.8; 26 mm	319
122 91 0183	Zrcátko hrtanové fig.9; 28 mm	Laryngeal mirror w/o handle fig.9; 28 mm	319
122 91 0184	Zrcátko hrtanové fig.10; 30 mm	Laryngeal mirror w/o handle fig.10; 30 mm	319
122 91 0185	Zrcátko hrtanové fig.00; 8 mm	Laryngeal mirror w/handle fig.00; 8 mm	319
122 91 0186	Zrcátko hrtanové fig.0; 10 mm	Laryngeal mirror w/handle fig.0; 10 mm	319
122 91 0187	Zrcátko hrtanové fig.1; 12 mm	Laryngeal mirror w/handle fig.1; 12 mm	319
122 91 0188	Zrcátko hrtanové fig.2; 14 mm	Laryngeal mirror w/handle fig.2; 14 mm	319
122 91 0189	Zrcátko hrtanové fig.3; 16 mm	Laryngeal mirror w/handle fig.3; 16 mm	319
122 91 0190	Zrcátko hrtanové fig.4; 18 mm	Laryngeal mirror w/handle fig.4; 18 mm	319
122 91 0191	Zrcátko hrtanové fig.5; 20 mm	Laryngeal mirror w/handle fig.5; 20 mm	319
122 91 0192	Zrcátko hrtanové fig.6; 22 mm	Laryngeal mirror w/handle fig.6; 22 mm	319
122 91 0193	Zrcátko hrtanové fig.7; 24 mm	Laryngeal mirror w/handle fig.7; 24 mm	319
122 91 0194	Zrcátko hrtanové fig.8; 26 mm	Laryngeal mirror w/handle fig.8; 26 mm	319
122 91 0195	Zrcátko hrtanové fig.9; 28 mm	Laryngeal mirror w/handle fig.9; 28 mm	319
122 91 0196	Zrcátko hrtanové fig.10; 30 mm	Laryngeal mirror w/handle fig.10; 30 mm	319
122 91 0200	Politzer zrcátko ušní sada fig.1-3	Politzer ear specula set fig.1-3	316
122 91 0201	Politzer zrcátko ušní fig.1; 2,0 mm	Politzer ear speculum fig.1; 2,0 mm	316
122 91 0202	Politzer zrcátko ušní fig.2; 3,0 mm	Politzer ear speculum fig.2; 3,0 mm	316
122 91 0203	Politzer zrcátko ušní fig.3; 4,0 mm	Politzer ear speculum fig.3; 4,0 mm	316
122 91 0204	Politzer zrcátko ušní fig.4; 5,0 mm	Politzer ear speculum fig.4; 5,0 mm	316
122 91 0205	Hartmann zrcátko ušní dětské sada fig.0-2	Hartmann f. children set fig.0-2	316
122 91 0206	Hartmann zrcátko ušní fig.0; 2,0 mm	Hartmann ear speculum fig.0; 2,0 mm	316
122 91 0207	Hartmann zrcátko ušní fig.1; 3,5 mm	Hartmann ear speculum fig.1; 3,5 mm	316
122 91 0208	Hartmann zrcátko ušní fig.2; 5,0 mm	Hartmann ear speculum fig.2; 5,0 mm	316
122 91 0209	Hartmann zrcátko ušní fig.3; 6,5 mm	Hartmann ear speculum fig.3; 6,5 mm	316
122 91 0210	Hartmann zrcátko ušní fig.4; 7,5 mm	Hartmann ear speculum fig.4; 7,5 mm	316
122 91 0211	Hartmann zrcátko ušní sada fig.2-4	Hartmann ear specula set fig.2-4	316
122 91 0212	Hartmann zrcátko ušní sada fig.1-4	Hartmann ear specula set fig.1-4	316
122 91 0213	Hartmann zrcátko ušní černé fig.0; 3,0 mm	Hartmann ear speculum black fig.0; 3,0 mm	316
122 91 0214	Hartmann zrcátko ušní černé fig.1; 4,0 mm	Hartmann ear speculum black fig.1; 4,0 mm	316
122 91 0215	Hartmann zrcátko ušní černé fig.2; 5,0 mm	Hartmann ear speculum black fig.2; 5,0 mm	316
122 91 0216	Hartmann zrcátko ušní černé fig.3; 7,0 mm	Hartmann ear speculum black fig.3; 7,0 mm	316
122 91 0217	Hartmann zrcátko ušní černé sada fig.0-3	Hartmann ear speculum black set fig.0-3	316
122 91 0296	Hartmann-Halle zrcátko nosní fig.1; 15,0 cm	Hartmann-Halle nasal spec. Fig.1; 15,0 cm	318
122 91 0298	Hartmann-Halle zrcátko nosní fig.2; 15,0 cm	Hartmann-Halle nasal spec. Fig.2; 15,0 cm	318

číslo – number	název	item	strana – page
122 91 0300	Hartmann-Halle zrcátko nosní fig.3; 15,0 cm	Hartmann-Halle nasal spec. Fig.3; 15,0 cm	318
122 91 0302	Hartmann zrcátko nosní fig.1; 15,0 cm	Hartmann nasal speculum fig.1; 15,0 cm	318
122 91 0304	Hartmann zrcátko nosní fig.2; 15,0 cm	Hartmann nasal speculum fig.2; 15,0 cm	318
122 91 0306	Hartmann zrcátko nosní fig.3; 15,0 cm	Hartmann nasal speculum fig.3; 15,0 cm	318
122 91 0308	Tieck-Halle zrcátko nosní fig.1; 13,5 cm	Tieck-Halle nasal speculum fig.1; 13,5 cm	318
122 91 0310	Tieck-Halle zrcátko nosní fig.2; 13,5 cm	Tieck-Halle nasal speculum fig.2; 13,5 cm	318
122 91 0328	Mod. Wien zrcátko nosní fig.1; 14,5 cm	Mod. Wien nasal speculum fig.1; 14,5 cm	318
122 91 0330	Mod. Wien zrcátko nosní fig.2; 14,5 cm	Mod. Wien nasal speculum fig.2; 14,5 cm	318
122 91 0332	Mod. Wien zrcátko nosní fig.3; 14,5 cm	Mod. Wien nasal speculum fig.3; 14,5 cm	318
122 91 0365	Sims zrcadlo rektální; 15,0 cm	Sims rectal speculum; 15,0 cm	320
122 91 0366	Sims zrcadlo rektální; 15,0 cm	Sims rectal speculum; 15,0 cm	320
122 91 0371	Pratt zrcadlo rektální; 21,0 cm	Pratt rectal speculum; 21,0 cm	320
122 91 0382	Ives-Fansler anoskop s gumovým obturátorem; 22 mm	Ives-Fansler anoscope with rubber obturator; 22 mm	321
122 91 0385	Hirschmann anoskop s obturátorem; 16×65 mm	Hirschmann anoscope with obturator; 16×65 mm	321
122 91 0386	Hirschmann anoskop s obturátorem; 19×65 mm	Hirschmann anoscope with obturator; 19×65 mm	321
122 91 0387	Hirschmann anoskop s obturátorem; 22×65 mm	Hirschmann anoscope with obturator; 22×65 mm	321
122 91 0388	Hirschmann anoskop s obturátorem; 22×125mm	Hirschmann anoscope with obturator; 22×125mm	321
122 91 0394	Bensaude anoskop s obturátorem; 19×70 mm	Bensaude anoscope with obturator; 19×70 mm	321
122 91 0395	Bensaude anoskop s obturátorem; 22×70 mm	Bensaude anoscope with obturator; 22×70 mm	321
122 91 0396	Kelly proktoskop s obturátorem; 22×50 mm	Kelly proctoscope with obturator; 22×50 mm	321
122 91 0397	Kelly proktoskop s obturátorem; 22×100 mm	Kelly proctoscope with obturator; 22×100 mm	321
122 91 0398	Kelly proktoskop s obturátorem; 22×140 mm	Kelly proctoscope with obturator; 22×140 mm	321
122 91 0399	Kelly proktoskop s obturátorem; 22×200 mm	Kelly proctoscope with obturator; 22×200 mm	321
122 91 0400	Kelly sphinkteroskop s obturátorem; 21×50 mm	Kelly sphincteroscope with obturator; 21×50 mm	321
122 91 0401	Kelly sphinkteroskop s obturátorem; 27×50 mm	Kelly sphincteroscope with obturator; 27×50 mm	321
123	PÁČIDLA	ELEVATORS	
123 08 0010	Langenbeck páčidlo fig.1; 19,5 cm	Langenbeck elevator fig.1; 19,5 cm	325
123 08 0020	Langenbeck páčidlo fig.2; 19,5 cm	Langenbeck elevator fig.2; 19,5 cm	325
123 08 0030	Williger páčidlo fig.1; 16,0 cm	Williger elevator fig.1; 16,0 cm	325
123 09 0030	Zahradníček páčidlo esovitě; 21,0 cm	Zahradníček elevator; 21,0 cm	325
123 09 0300	Hohmann páčidlo přímé tupé fig.1; 14,0 cm	Hohmann elevator fig.1; 14,0 cm	325
123 09 0310	Hohmann páčidlo přímé tupé fig.2; 19,6 cm	Hohmann elevator fig.2; 19,6 cm	325
123 09 0320	Hohmann páčidlo přímé ostré fig.1; 14,0 cm	Hohmann elevator fig.1; 14,0 cm	325
123 09 0330	Hohmann páčidlo přímé ostré fig.2; 19,6 cm	Hohmann elevator fig.2; 19,6 cm	325
123 09 0340	Hohmann páčidlo prohnuté tupé fig.1; 12,7 cm	Hohmann elevator fig.1; 12,7 cm	325
123 09 0350	Hohmann páčidlo prohnuté tupé fig.2; 18,3 cm	Hohmann elevator fig.2; 18,3 cm	325
123 09 0360	Hohmann páčidlo prohnuté ostré fig.1; 12,7 cm	Hohmann elevator fig.1; 12,7 cm	325
123 09 0370	Hohmann páčidlo prohnuté ostré fig.2; 18,3 cm	Hohmann elevator fig.2; 18,3 cm	325
123 09 0400	Páčidlo prohnuté široké; 22,7 cm	Elevator; 22,7 cm	328
123 17 0040	Uvolňovač na preparaci nervů jemný; 17,0 cm	Nerve elevator; 17,0 cm	332
123 17 0110	Sachs uvolňovač tvrdé pleny; 22,5 cm	Sachs dura elevator; 22,5 cm	332
123 29 0010	Páčka ušní zahnutá; 16,0 cm	Ear elevator; 16,0 cm	333
123 29 0020	Lucae páčka ušní; 2,0 mm; 15,0 cm	Lucae ear elevator; 2,0 mm; 15,0 cm	333
123 29 0030	Lucae páčka ušní; 3,0 mm; 15,0 cm	Lucae ear elevator; 3,0 mm; 15,0 cm	333
123 29 0040	Lucae páčka ušní; 4,0 mm; 15,0 cm	Lucae ear elevator; 4,0 mm; 15,0 cm	333
123 29 0080	Lucae páčka ušní lžičkovitá; 2,2 mm; 16,0 cm	Lucae ear elevator; 2,2 mm; 16,0 cm	333
123 30 0030	Freer páčidlo na nosní přepážku dvojité; 17,9 cm	Freer septum elevator; 17,9 cm	333
123 91 0006	Freer páčidlo nosní ostré; 19,0 cm	Freer nasal elevator; 19,0 cm	334
123 91 0007	Freer páčidlo nosní tupé; 19,0 cm	Freer nasal elevator; 19,0 cm	334
123 91 0008	Freer páčidlo nosní ostro-tupé; 18,0cm	Freer nasal elevator; 18,0cm	334
123 91 0009	Cottle páčidlo nosní; 23,0 cm	Cottle nasal elevator; 23,0 cm	334
123 91 0010	McKenty páčidlo nosní; 22,0 cm	McKenty nasal elevator; 22,0 cm	334
123 91 0011	Cottle páčidlo nosní; 21,0 cm	Cottle nasal elevator; 21,0 cm	335
123 91 0012	Masing páčidlo nosní; 21,0 cm	Masing nasal elevator; 21,0 cm	335
123 91 0013	Howarth páčidlo nosní; 21,5 cm	Howarth nasal elevator; 21,5 cm	335
123 91 0014	Killian páčidlo nosní; 18,0 cm	Killian nasal elevator; 18,0 cm	335
123 91 0015	Killian páčidlo nosní; 22,0 cm	Killian nasal elevator; 22,0 cm	335
123 91 0026	Hohmann páka kostní; 24 mm; 28 cm	Hohmann bone elevator; 24 mm; 28 cm	331
123 91 0027	Mini-Hohmann páka kostní; 6 mm; 16 cm	Mini-Hohmann bone elevator; 6 mm; 16 cm	329
123 91 0028	Mini-Hohmann páka kostní; 8 mm; 16 cm	Mini-Hohmann bone elevator; 8 mm; 16 cm	329
123 91 0029	Hohmann páka kostní; 35 mm; 29 cm	Hohmann bone elevator; 35 mm; 29 cm	331
123 91 0030	Páka kostní; 6 mm; 14 cm	Bone elevator; 6 mm; 14 cm	329
123 91 0031	Páka kostní; 15 mm; 17 cm	Bone elevator; 15 mm; 17 cm	329
123 91 0032	Páka kostní; 16 mm; 12 cm	Bone elevator; 16 mm; 12 cm	329
123 91 0033	Hohmann páka kostní; 8 mm; 22 cm	Hohmann bone elevator; 8 mm; 22 cm	330
123 91 0034	Hohmann páka kostní; 18 mm; 24 cm	Hohmann bone elevator; 18 mm; 24 cm	330
123 91 0035	Hohmann páka kostní; 43 mm; 26 cm	Hohmann bone elevator; 43 mm; 26 cm	330
123 91 0036	Hohmann páka kostní; 70 mm; 29 cm	Hohmann bone elevator; 70 mm; 29 cm	330
123 91 0037	Hohmann páka kostní; 22 mm; 25 cm	Hohmann bone elevator; 22 mm; 25 cm	331
123 91 0038	Hohmann páka kostní; 43 mm; 25 cm	Hohmann bone elevator; 43 mm; 25 cm	331
123 91 0039	Lange-Hohmann páka kostní; 22 mm; 26 cm	Lange-Hohmann bone elevator; 22 mm; 26 cm	331

číslo – number	název	item	strana – page
123 91 0040	Blount páka kostní; 26 cm	Blount bone elevator; 26 cm	332
123 91 0041	Blount páka kostní; 26 cm	Blount bone elevator; 26 cm	332
123 91 0042	Taylor páka kostní; 75×30 mm; 16,5 cm	Taylor bone elevator; 75×30 mm; 16,5 cm	332
123 91 0043	Taylor páka kostní; 100×30 mm; 16,5 cm	Taylor bone elevator; 100×30 mm; 16,5 cm	332
123 99 0004	Páčidlo dvouzubé široké prohnuté; 29,5 cm	Elevator; 29,5 cm	326
123 99 0006	Páčidlo slabě prohnuté dvouzubé; 14,0 cm	Elevator; 14,0 cm	327
123 99 0007	Páčidlo silně prohnuté dvouzubé; 12,7 cm	Elevator; 12,7 cm	327
123 99 0016	Hohmann páčidlo dvouzubé úzké; 25,5 cm	Hohmann elevator; 25,5 cm	327
123 99 0033	Páčidlo úzké ostré; 24,0 cm	Elevator; 24,0 cm	327
123 99 0060	Páčidlo široké tupé; 24,5 cm	Elevator; 24,5 cm	327
123 99 0067	Páčidlo prohnuté široké; 45×250 mm	Elevator bent wide; 45×250 mm	326
123 99 0084	Páčidlo na nosní přepážku	Septum nasal elevator	333
123 99 0097	Páčidlo tupé široké; 11 mm	Elevator blunt wide; 11 mm	328
123 99 0101	Páčidlo tupé; 12 mm; 240 mm	Elevator blunt; 12 mm; 240 mm	327
123 99 0102	Páčidlo ostré; 12 mm; 240 mm	Elevator sharp; 12 mm; 240 mm	327
124	ŠKRABKY	RASPATORIES	
124 08 0111	Williger škrabka fig.2; 16,0 cm	Williger raspatory fig.2; 16,0 cm	339
124 08 0120	Langenbeck škrabka rovná; 20,5 cm	Langenbeck raspatory; 20,5 cm	339
124 08 0130	Langenbeck škrabka zahnutá; 20,4 cm	Langenbeck raspatory; 20,4 cm	339
124 08 0170	Farabeuf škrabka rovná; 14,5 cm	Farabeuf raspatory; 14,5 cm	339
124 08 0180	Farabeuf škrabka zahnutá; 14,5 cm	Farabeuf raspatory; 14,5 cm	339
124 08 0250	Williger škrabka; 5,0 mm; 16,0 cm	Williger raspatory; 5,0 mm; 16,0 cm	339
124 08 0280	Williger škrabka rovná; 3,5 mm; 16,0 cm	Williger raspatory; 3,5 mm; 16,0 cm	339
124 08 0290	Williger škrabka zahnutá; 3,5 mm; 16,0 cm	Williger raspatory; 3,5 mm; 16,0 cm	339
124 10 0101	Doyen škrabka na žebra dětská levá; 15,0 cm	Doyen rib raspatory; 15,0 cm	340
124 10 0111	Doyen škrabka na žebra dětská pravá; 15,0 cm	Doyen rib raspatory; 15,0 cm	340
124 14 0020	Škrabka žlábková; 21,6 cm	Raspatory; 21,6 cm	340
124 14 0021	Škrabka žlábková; 22,1 cm	Raspatory; 22,1 cm	340
124 14 0030	Škrabka exartikulační rovná; 20,8 cm	Raspatory; 20,8 cm	340
124 14 0031	Škrabka exartikulační zahnutá; 20,8 cm	Raspatory; 20,8 cm	340
124 14 0040	Sauerbruch škrabka zahnutá; 21,6 cm	Sauerbruch raspatory; 21,6 cm	341
124 14 0041	Sauerbruch škrabka zahnutá; 22,1 cm	Sauerbruch raspatory; 22,1 cm	341
124 14 0050	Ollier škrabka okrouhlá rovná; 12,0 mm; 22,6 cm	Ollier raspatory; 12,0 mm; 22,6 cm	341
124 14 0051	Ollier škrabka okrouhlá rovná; 12,0 mm; 23,1 cm	Ollier raspatory; 12,0 mm; 23,1 cm	341
124 14 0060	Ollier škrabka okrouhlá rovná; 16,0 mm; 22,6 cm	Ollier raspatory; 16,0 mm; 22,6 cm	341
124 14 0061	Ollier škrabka okrouhlá rovná; 16,0 mm; 23,1 cm	Ollier raspatory; 16,0 mm; 23,1 cm	341
124 14 0070	Ollier škrabka okrouhlá rovná; 18,0 mm; 22,6 cm	Ollier raspatory; 18,0 mm; 22,6 cm	341
124 14 0071	Ollier škrabka okrouhlá rovná; 18,0 mm; 23,1 cm	Ollier raspatory; 18,0 mm; 23,1 cm	341
124 14 0110	Ollier škrabka exartikulační žláb. rovná; 19,3 cm	Ollier raspatory; 19,3 cm	341
124 14 0111	Ollier škrabka exartikulační žláb. zahnutá; 19,8 cm	Ollier raspatory; 19,8 cm	341
124 14 0130	Škrabka exartikulační prohnutá; 6,0 mm; 20,0 cm	Raspatory; 6,0 mm; 20,0 cm	342
124 14 0181	Doyen škrabka na žebra pravá; 15,5 cm	Doyen rib raspatory; 15,5 cm	340
124 14 0191	Doyen škrabka na žebra levá; 15,5 cm	Doyen rib raspatory; 15,5 cm	340
124 27 0011	Ayer škrabka děložní; 22,0 cm	Ayer uterine raspatory; 22,0 cm	342
124 30 0020	Přecechtěl škrabka nosní; 19,0 cm	Přecechtěl nasal raspatory; 19,0 cm	342
124 32 0010	Hurd škrabka na mandle; 12×8 mm; 21,0 cm	Hurd tonsil raspatory; 12×8 mm; 21,0 cm	342
124 38 0010	Škrabka na rohovku rovná; 12,5 cm	Corneal scarifier; 12,5 cm	342
124 38 0070	Škrabka na rohovku lomená; 12,5 cm	Corneal scarifier; 12,5 cm	342
124 38 0160	Škrabka na operaci slzného vaku; 17,2 cm	Lachrymal sac raspatory; 17,2 cm	342
125	LŽIČKY	SPOONS	
125 08 0110	Lžička ostrá oválná fig.000; 3,5 mm; 17,0 cm	Spoon sharp fig.000; 3,5 mm; 17,0 cm	345
125 08 0120	Lžička ostrá oválná fig.0; 4,8 mm; 17,2 cm	Spoon sharp fig.0; 4,8 mm; 17,2 cm	345
125 08 0130	Lžička ostrá oválná fig.1; 6,0 mm; 17,5 cm	Spoon sharp fig.1; 6,0 mm; 17,5 cm	345
125 08 0140	Lžička ostrá oválná fig.3; 8,5 mm; 17,7 cm	Spoon sharp fig.3; 8,5 mm; 17,7 cm	345
125 08 0150	Lžička ostrá oválná fig.5; 12,0 mm; 18,4 cm	Spoon sharp fig.5; 12,0 mm; 18,4 cm	345
125 08 0160	Lžička ostrá trepanační fig.1; 3,0 mm; 16,5 cm	Spoon sharp fig.1; 3,0 mm; 16,5 cm	345
125 08 0170	Lžička ostrá trepanační fig.2; 3,5 mm; 16,5 cm	Spoon sharp fig.2; 3,5 mm; 16,5 cm	345
125 08 0180	Lžička ostrá trepanační fig.3; 4,0 mm; 17,5 cm	Spoon sharp fig.3; 4,0 mm; 17,5 cm	345
125 08 0190	Lžička ostrá trepanační fig.4; 5,0 mm; 17,5 cm	Spoon sharp fig.4; 5,0 mm; 17,5 cm	345
125 08 0200	Lžička ostrá trepanační fig.5; 6,0 mm; 19,5 cm	Spoon sharp fig.5; 6,0 mm; 19,5 cm	345
125 08 0210	Lžička ostrá trepanační fig.6; 6,7 mm; 19,5 cm	Spoon sharp fig.6; 6,7 mm; 19,5 cm	345
125 08 0310	Volkman lžička ostrá; 8,5; 5,5 mm; 13,5 cm	Volkman spoon; 8,5; 5,5 mm; 13,5 cm	346
125 09 0010	Lžička ortopedická; 14,5×24 mm; 350 mm	Spoon orthopaedic; 14,5×24 mm; 350 mm	351
125 17 0120	Lžička na páteř; 2×4 mm; 215 mm	Spinal spoon; 2×4 mm; 215 mm	349
125 17 0130	Lžička na páteř; 3×4 mm; 215 mm	Spinal spoon; 3×4 mm; 215 mm	349
125 17 0140	Lžička na páteř; 4×8 mm; 215 mm	Spinal spoon; 4×8 mm; 215 mm	349
125 17 0150	Lžička na páteř; 5×9 mm; 215 mm	Spinal spoon; 5×9 mm; 215 mm	349
125 17 0160	Lžička na páteř; 9×12 mm; 215 mm	Spinal spoon; 9×12 mm; 215 mm	349
125 17 0170	Lžička na páteř; 12×16 mm; 215 mm	Spinal spoon; 12×16 mm; 215 mm	349
125 17 0250	Lžička ostrá rovná; 7×10 mm; 300 mm	Spoon sharp straight; 7×10 mm; 300 mm	349
125 17 0260	Lžička ostrá rovná; 9×12 mm; 300 mm	Spoon sharp straight; 9×12 mm; 300 mm	349

číslo – number	název	item	strana – page
125 17 0270	Lžička ostrá rovná; 12×18 mm; 300 mm	Spoon sharp straight; 12×18 mm; 300 mm	349
125 17 0300	Cloward lžička přímá 45°; 4,2 mm; 230 mm	Cloward spoon straight 45°; 4,2 mm; 230 mm	350
125 17 0310	Cloward lžička vyhnutá vpravo; 4,8×5,5 mm; 230mm	Cloward spoon right bent; 4,8×5,5 mm; 230mm	350
125 17 0320	Cloward lžička vyhnutá vlevo; 4,8×5,5 mm; 230 mm	Cloward spoon left bent; 4,8×5,5 mm; 230 mm	350
125 17 0410	Lžička páteřní rovná; 13,5×19 mm; 325 mm	Spinal spoon straight; 13,5×19 mm; 325 mm	351
125 17 0420	Lžička páteřní zahnutá; 13,5×19 mm; 325 mm	Spinal spoon bent; 13,5×19 mm; 325 mm	351
125 17 0430	Lžička páteřní rovná; 12×16 mm; 325 mm	Spinal spoon straight; 12×16 mm; 325 mm	351
125 17 0440	Lžička páteřní zahnutá; 12×16 mm; 325 mm	Spinal spoon bent; 12×16 mm; 325 mm	351
125 17 0450	Lžička páteřní rovná; 8,5×11 mm; 325 mm	Spinal spoon straight; 8,5×11 mm; 325 mm	351
125 17 0460	Lžička páteřní zahnutá; 8,5×11 mm; 325 mm	Spinal spoon bent; 8,5×11 mm; 325 mm	351
125 27 0050	Lžička děložní oválná; 7×10 mm; 30,0 cm	Uterine spoon; 7×10 mm; 30,0 cm	347
125 27 0060	Lžička děložní oválná; 12×18 mm; 30,0 cm	Uterine spoon; 12×18 mm; 30,0 cm	347
125 27 0070	Recamier lžička děložní fig.1; 6,8 mm; 31,0 cm	Recamier uterine spoon fig.1; 6,8 mm; 31,0 cm	347
125 27 0080	Recamier lžička děložní fig.2; 8,5 mm; 31,0 cm	Recamier uterine spoon fig.2; 8,5 mm; 31,0 cm	347
125 27 0090	Recamier lžička děložní fig.3; 10,0 mm; 31,0 cm	Recamier uterine spoon fig.3; 10,0 mm; 31,0 cm	347
125 27 0100	Recamier lžička děložní fig.4; 11,5 mm; 31,0 cm	Recamier uterine spoon fig.4; 11,5 mm; 31,0 cm	347
125 27 0110	Recamier lžička děložní fig.5; 13,0 mm; 31,0 cm	Recamier uterine spoon fig.5; 13,0 mm; 31,0 cm	347
125 27 0120	Recamier lžička děložní fig.6; 14,5 mm; 31,0 cm	Recamier uterine spoon fig.6; 14,5 mm; 31,0 cm	347
125 30 0100	Halle lžička nosní ostrá ohebná; 6×4 mm; 23,0 cm	Halle nasal spoon; 6×4 mm; 23,0 cm	347
125 30 0110	Halle lžička nosní ostrá ohebná; 9×5 mm; 23,0 cm	Halle nasal spoon; 9×5 mm; 23,0 cm	347
125 38 0010	Meyhöfer lžička na chalazia kulatá; 1,6 mm	Meyhöfer chalazion spoon; 1,6 mm	348
125 38 0020	Meyhöfer lžička na chalazia kulatá; 2,2 mm	Meyhöfer chalazion spoon; 2,2 mm	348
125 38 0030	Meyhöfer lžička na chalazia kulatá; 2,8 mm	Meyhöfer chalazion spoon; 2,8 mm	348
125 38 0040	Meyhöfer lžička na chalazia kulatá; 3,4 mm	Meyhöfer chalazion spoon; 3,4 mm	348
125 38 0050	Meyhöfer lžička na chalazia kulatá; 4,0 mm	Meyhöfer chalazion spoon; 4,0 mm	348
125 38 0170	Bunge lžička exenterační; 15×12,5 mm; 16,0 cm	Bunge exenteration spoon; 15×12,5 mm; 16,0 cm	348
125 38 0360	Daviel lžička oční s lopatkou fig.1; 1×1,6 mm	Daviel eye spoon with spatula fig.1; 1×1,6 mm	348
125 38 0370	Daviel lžička oční s lopatkou fig.2; 1×2,2 mm	Daviel eye spoon with spatula fig.2; 1×2,2 mm	348
125 38 0530	Lang lžička oční ostrá; 3,5×4,5 mm; 15,0 cm	Lang eye spoon; 3,5×4,5 mm; 15,0 cm	348
125 91 0148	Luer-Koerte lžička na žlučové kameny; 2,5 mm; 32 cm	Luer-Koerte gall stone scoop; 2,5 mm; 32 cm	346
125 91 0149	Luer-Koerte lžička na žlučové kameny; 3,2 mm; 32 cm	Luer-Koerte gall stone scoop; 3,2 mm; 32 cm	346
125 91 0150	Luer-Koerte lžička na žlučové kameny; 4,2 mm; 32 cm	Luer-Koerte gall stone scoop; 4,2 mm; 32 cm	346
125 91 0151	Luer-Koerte lžička na žlučové kameny; 5,5 mm; 32 cm	Luer-Koerte gall stone scoop; 5,5 mm; 32 cm	346
125 91 0152	Luer-Koerte lžička na žlučové kameny; 6,7 mm; 32 cm	Luer-Koerte gall stone scoop; 6,7 mm; 32 cm	346
125 91 0153	Luer-Koerte lžička na žlučové kameny; 8 mm; 32 cm	Luer-Koerte gall stone scoop; 8 mm; 32 cm	346
125 91 0154	Luer-Koerte lžička na žlučové kameny; 11 mm; 32 cm	Luer-Koerte gall stone scoop; 11 mm; 32 cm	346
125 91 0155	Luer-Koerte lžička na žlučové kameny; 15 mm; 32 cm	Luer-Koerte gall stone scoop; 15 mm; 32 cm	346
126	KYRETY	CURETTES	
126 27 0010	Kyreta děložní ostrá fig.1	Uterine curette sharp fig.1	355
126 27 0011	Kyreta děložní ostrá fig.1	Uterine curette sharp fig.1	355
126 27 0012	Kyreta děložní ostrá fig.1	Uterine curette sharp fig.1	356
126 27 0020	Kyreta děložní ostrá fig.2	Uterine curette sharp fig.2	355
126 27 0021	Kyreta děložní ostrá fig.2	Uterine curette sharp fig.2	355
126 27 0022	Kyreta děložní ostrá fig.2	Uterine curette sharp fig.2	356
126 27 0030	Kyreta děložní ostrá fig.3	Uterine curette sharp fig.3	355
126 27 0031	Kyreta děložní ostrá fig.3	Uterine curette sharp fig.3	355
126 27 0032	Kyreta děložní ostrá fig.3	Uterine curette sharp fig.3	356
126 27 0040	Kyreta děložní ostrá fig.4	Uterine curette sharp fig.4	355
126 27 0041	Kyreta děložní ostrá fig.4	Uterine curette sharp fig.4	355
126 27 0042	Kyreta děložní ostrá fig.4	Uterine curette sharp fig.4	356
126 27 0050	Kyreta děložní ostrá fig.5	Uterine curette sharp fig.5	355
126 27 0051	Kyreta děložní ostrá fig.5	Uterine curette sharp fig.5	355
126 27 0052	Kyreta děložní ostrá fig.5	Uterine curette sharp fig.5	356
126 27 0060	Kyreta děložní ostrá fig.6	Uterine curette sharp fig.6	355
126 27 0061	Kyreta děložní ostrá fig.6	Uterine curette sharp fig.6	355
126 27 0062	Kyreta děložní ostrá fig.6	Uterine curette sharp fig.6	356
126 27 0070	Kyreta děložní ostrá fig.7	Uterine curette sharp fig.7	355
126 27 0071	Kyreta děložní ostrá fig.7	Uterine curette sharp fig.7	355
126 27 0072	Kyreta děložní ostrá fig.7	Uterine curette sharp fig.7	356
126 27 0080	Kyreta děložní ostrá fig.8	Uterine curette sharp fig.8	355
126 27 0081	Kyreta děložní ostrá fig.8	Uterine curette sharp fig.8	355
126 27 0082	Kyreta děložní ostrá fig.8	Uterine curette sharp fig.8	356
126 27 0110	Kyreta děložní tupá fig.1	Uterine curette blunt fig.1	356
126 27 0111	Kyreta děložní tupá fig.1	Uterine curette blunt fig.1	357
126 27 0112	Kyreta děložní tupá fig.1	Uterine curette blunt fig.1	357
126 27 0120	Kyreta děložní tupá fig.2	Uterine curette blunt fig.2	356
126 27 0121	Kyreta děložní tupá fig.2	Uterine curette blunt fig.2	357
126 27 0122	Kyreta děložní tupá fig.2	Uterine curette blunt fig.2	357
126 27 0130	Kyreta děložní tupá fig.3	Uterine curette blunt fig.3	356
126 27 0131	Kyreta děložní tupá fig.3	Uterine curette blunt fig.3	357
126 27 0132	Kyreta děložní tupá fig.3	Uterine curette blunt fig.3	357

číslo – number	název	item	strana – page
126 27 0140	Kyreta děložní tupá fig.4	Uterine curette blunt fig.4	356
126 27 0141	Kyreta děložní tupá fig.4	Uterine curette blunt fig.4	357
126 27 0142	Kyreta děložní tupá fig.4	Uterine curette blunt fig.4	357
126 27 0150	Kyreta děložní tupá fig.5	Uterine curette blunt fig.5	356
126 27 0151	Kyreta děložní tupá fig.5	Uterine curette blunt fig.5	357
126 27 0152	Kyreta děložní tupá fig.5	Uterine curette blunt fig.5	357
126 27 0160	Kyreta děložní tupá fig.6	Uterine curette blunt fig.6	356
126 27 0161	Kyreta děložní tupá fig.6	Uterine curette blunt fig.6	357
126 27 0162	Kyreta děložní tupá fig.6	Uterine curette blunt fig.6	357
126 27 0170	Kyreta děložní tupá fig.7	Uterine curette blunt fig.7	356
126 27 0171	Kyreta děložní tupá fig.7	Uterine curette blunt fig.7	357
126 27 0172	Kyreta děložní tupá fig.7	Uterine curette blunt fig.7	357
126 27 0180	Kyreta děložní tupá fig.8	Uterine curette blunt fig.8	356
126 27 0181	Kyreta děložní tupá fig.8	Uterine curette blunt fig.8	357
126 27 0182	Kyreta děložní tupá fig.8	Uterine curette blunt fig.8	357
126 32 0080	Smyčka drátěná; 0,3 mm; 4,8 cm	Wire loop for tonsil; 0,3 mm; 4,8 cm	358
126 32 0090	Smyčka drátěná; 0,4 mm; 4,8 cm	Wire loop for tonsil; 0,4 mm; 4,8 cm	358
126 32 0110	Smyčka drátěná; 0,5 mm; 4,8 cm	Wire loop for tonsil; 0,5 mm; 4,8 cm	358
126 32 0120	Smyčka drátěná; 0,3 mm; 4,0 cm	Wire loop for tonsil; 0,3 mm; 4,0 cm	358
126 32 0130	Smyčka drátěná; 0,4 mm; 4,0 cm	Wire loop for tonsil; 0,4 mm; 4,0 cm	358
126 32 0140	Smyčka drátěná; 0,5 mm; 4,0 cm	Wire loop for tonsil; 0,5 mm; 4,0 cm	358
126 32 0160	Smyčka drátěná; 0,4 mm; 4,5 cm	Wire loop for tonsil; 0,4 mm; 4,5 cm	358
126 91 0001	Bruenings skřípec na mandle; 28,0 cm	Bruenings tonsil snare; 28,0 cm	358
127	PILKY, PILNÍKY	SAWS, FILES	
127 08 0030	Gutsch pilka rámová; 31,5 cm	Gutsch bone saw; 31,5 cm	362
127 08 0040	List pilky; 10 zubů na 1"; 16 mm; 26,5 cm	List of saw 10 teeth for 1"; 16 mm; 26,5 cm	362
127 08 0050	List pilky; 14 zubů na 1"; 16 mm; 26,5 cm	List of saw 14 teeth for 1"; 16 mm; 26,5 cm	362
127 08 0060	List pilky; 18 zubů na 1"; 16 mm; 26,5 cm	List of saw 18 teeth for 1"; 16 mm; 26,5 cm	362
127 08 0270	Škrabka vyhnutá; 15,9 cm	Rasp eschewed; 15,9 cm	363
127 17 0011	Olivercrome pilka drátěná; 32,0 cm	Olivercrome wire saw; 32,0 cm	362
127 17 0021	Olivercrome pilka drátěná; 40,0 cm	Olivercrome wire saw; 40,0 cm	362
127 17 0051	Držátko drátěných pilek pevné (pár); 8,0 cm	Hook handle (couple); 8,0 cm	362
127 30 0010	Holbrook-Curtis pilka nosní rovná; 18,0 cm	Holbrook-Curtis nasal saw; 18,0 cm	363
127 30 0100	Joseph pilka na kosti fig.1; 16,5 cm	Joseph nasal rasp fig.1; 16,5 cm	363
127 30 0110	Joseph pilka na kosti fig.2; 16,5 cm	Joseph nasal rasp fig.2; 16,5 cm	363
127 30 0120	Joseph pilka na kosti fig.3; 16,5 cm	Joseph nasal rasp fig.3; 16,5 cm	363
127 30 0130	Joseph pilka na kosti fig.4; 16,5 cm	Joseph nasal rasp fig.4; 16,5 cm	363
127 91 0001	Wigmore pilka na sádrové obvazy; 19,0 cm	Wigmore plaster-of-paris saw; 19,0 cm	361
127 91 0002	Engel pilka na sádrové obvazy; 14,0 cm	Engel plaster-of-paris saw; 14,0 cm	361
127 91 0003	Elektrická pilka na sádrové obvazy; 220V	Oscillating plaster-saw; 220V	361
127 91 0004	Elektrická pilka na sádrové obvazy; 110V	Oscillating plaster-saw; 110V	361
127 91 0005	List pilky pro tvrdou sádku; 50 mm	Saw blade for hard plaster; 50 mm	361
127 91 0006	List pilky pro tvrdou sádku; 65 mm	Saw blade for hard plaster; 65 mm	361
127 91 0007	Klíč	Spanner only	361
127 91 0052	Pilník; 22,0 cm	Bone file; 22,0 cm	364
127 91 0053	Pilník; 24,5 cm	Bone file; 24,5 cm	364
127 91 0054	Pilník; 28,0 cm	Bone file; 28,0 cm	364
127 91 0055	Putti rašple; 27,0 cm	Putti rasp; 27,0 cm	364
127 91 0056	Putti rašple; 30,0 cm	Putti rasp; 30,0 cm	364
128	DLÁTA, KLADIVA	CHISELS, MALLETS	
128 01 0030	Páka na lebku; 14,5 cm	Skull breaker; 14,5 cm	367
128 01 0050	Kladívko pitevné s hákem; 24,5 cm	Post mortem hammer with hook; 24,5 cm	367
128 08 0010	Stille dláto ploché; 210×10 mm	Stille chisel; 210×10 mm	368
128 08 0030	Stille dláto ploché; 210×15 mm	Stille chisel; 210×15 mm	368
128 08 0040	Stille dláto ploché; 210×20 mm	Stille chisel; 210×20 mm	368
128 08 0050	Stille dláto ploché; 210×25 mm	Stille chisel; 210×25 mm	368
128 08 0160	Stille dláto poloklínové; 210×15×4 mm	Stille chisel; 210×15×4 mm	368
128 08 0170	Stille dláto poloklínové; 210×15×6 mm	Stille chisel; 210×15×6 mm	368
128 08 0180	Stille dláto poloklínové; 210×15×8 mm	Stille chisel; 210×15×8 mm	368
128 08 0250	Dláto žlábkové obloukové; 210×10 mm	Gouge; 210×10 mm	369
128 08 0260	Dláto žlábkové obloukové; 210×15 mm	Gouge; 210×15 mm	369
128 08 0270	Dláto žlábkové obloukové; 210×20 mm	Gouge; 210×20 mm	369
128 08 0280	Dláto žlábkové obloukové; 210×25 mm	Gouge; 210×25 mm	369
128 08 0290	Dláto žlábkové obloukové; 210×30 mm	Gouge; 210×30 mm	369
128 08 0300	Dláto žlábkové rovné; 210×10 mm	Gouge; 210×10 mm	369
128 08 0310	Dláto žlábkové rovné; 210×15 mm	Gouge; 210×15 mm	369
128 08 0320	Dláto žlábkové rovné; 210×20 mm	Gouge; 210×20 mm	369
128 08 0330	Dláto žlábkové rovné; 210×25 mm	Gouge; 210×25 mm	369
128 08 0340	Dláto žlábkové rovné; 210×30 mm	Gouge; 210×30 mm	369
128 08 0350	Dláto žlábkové rovné; 210×35 mm	Gouge; 210×35 mm	369
128 08 0390	Dláto žlábkové obloukové; 210×35 mm	Gouge; 210×35 mm	369

číslo – number	název	item	strana – page
128 08 0901	Kladívko chirurgické kovové; 250g	Mallet 250g – metallic; 250g	367
128 08 0911	Kladívko chirurgické kovové; 500g	Mallet 500g – metallic; 500g	367
128 08 0921	Kladívko chirurgické kovové; 700g	Mallet 700g – metallic; 700g	367
128 08 1050	Stille dláto ploché; 210×6 mm	Stille chisel; 210×6 mm	368
128 12 0100	Dláto na nosní plastiku fig.1; 190×4 mm	Nasal plastic chisel fig.1; 190×4 mm	370
128 12 0110	Dláto na nosní plastiku fig.1; 190×6 mm	Nasal plastic chisel fig.1; 190×6 mm	370
128 12 0120	Dláto na nosní plastiku; 190×10 mm	Nasal plastic chisel; 190×10 mm	370
128 12 0130	Dláto na nosní plastiku; 190×12 mm	Nasal plastic chisel; 190×12 mm	370
128 12 0140	Dláto na nosní plastiku; 190×14 mm	Nasal plastic chisel; 190×14 mm	370
128 12 0160	Dláto na nosní plastiku fig.2; 180×4 mm	Nasal plastic chisel fig.2; 180×4 mm	370
128 12 0170	Dláto na nosní plastiku fig.2; 180×6 mm	Nasal plastic chisel fig.2; 180×6 mm	370
128 12 0180	Dláto na nosní plastiku fig.2; 180×10 mm	Nasal plastic chisel fig.2; 180×10 mm	370
128 12 0190	Dláto na nosní plastiku fig.2; 180×12 mm	Nasal plastic chisel fig.2; 180×12 mm	370
128 12 0270	Dláto na nosní plastiku vyhnuté fig.1; 190×10 mm	Nasal plastic chisel eschewed fig.1; 190×10 mm	370
128 12 0280	Dláto na nosní plastiku vyhnuté fig.1; 190×12 mm	Nasal plastic chisel eschewed fig.1; 190×12 mm	370
128 12 0290	Dláto na nosní plastiku vyhnuté fig.1; 190×14 mm	Nasal plastic chisel eschewed fig.1; 190×14 mm	370
128 29 0410	Stacke dláto ušní žlábkové dopředu zahnuté; 140×4 mm	Stacke ear gouge; 140×4 mm	371
128 29 0420	Stacke dláto ušní žlábkové dopředu zahnuté; 140×6 mm	Stacke ear gouge; 140×6 mm	371
128 29 0430	Stacke dláto ušní žlábkové dopředu zahnuté; 140×8 mm	Stacke ear gouge; 140×8 mm	371
128 29 0440	Stacke dláto ušní žlábkové dopředu zahnuté; 140×10 mm	Stacke ear gouge; 140×10 mm	371
128 29 0510	Stacke dláto ušní žlábkové dozadu zahnuté; 140×4 mm	Stacke ear gouge; 140×4 mm	371
128 29 0520	Stacke dláto ušní žlábkové dozadu zahnuté; 140×6 mm	Stacke ear gouge; 140×6 mm	371
128 29 0530	Stacke dláto ušní žlábkové dozadu zahnuté; 140×8 mm	Stacke ear gouge; 140×8 mm	371
128 29 0540	Stacke dláto ušní žlábkové dozadu zahnuté; 140×10 mm	Stacke ear gouge; 140×10 mm	371
128 29 0750	Stacke chránič dlátek; 15,0 cm	Stacke chisel guide; 15,0 cm	367
128 30 0010	Dláto žlábkové nosní; 180×2 mm	Nasal gouge; 180×2 mm	371
128 30 0030	Dláto žlábkové nosní; 180×4 mm	Nasal gouge; 180×4 mm	371
128 30 0040	Dláto žlábkové nosní; 180×5 mm	Nasal gouge; 180×5 mm	371
128 30 0200	West dláto ploché nosní; 180×2 mm	West nasal chisel; 180×2 mm	371
128 30 0230	West dláto ploché nosní; 180×5 mm	West nasal chisel; 180×5 mm	371
128 91 0202	Silver dláto na nosní plastiku; 18 cm	Silver nasal plastic chisel; 18 cm	370
128 91 0203	Silver dláto na nosní plastiku; 18 cm	Silver nasal plastic chisel; 18 cm	370
128 91 0214	Lebsche nástroj na sternum; 25 cm	Lebsche sternum chisel; 25 cm	367
128 99 0031	Lambotte dláto neurochirurgické; 10×180 mm	Lambotte neurosurgical osteotom; 10×180 mm	372
128 99 0032	Lambotte dláto neurochirurgické; 15×180 mm	Lambotte neurosurgical osteotom; 15×180 mm	372
128 99 0033	Lambotte dláto neurochirurgické; 20×180 mm	Lambotte neurosurgical osteotom; 20×180 mm	372
128 99 0035	Lambotte dláto neurochirurgické; 25×180 mm	Lambotte neurosurgical osteotom; 25×180 mm	372
128 99 0036	Lambotte dláto neurochirurgické; 30×180 mm	Lambotte neurosurgical osteotom; 30×180 mm	372
128 99 0037	Lambotte dláto neurochirurgické; 35×180 mm	Lambotte neurosurgical osteotom; 35×180 mm	372
128 99 0038	Lambotte dláto neurochirurgické; 40×180 mm	Lambotte neurosurgical osteotom; 40×180 mm	372
131	FRÉZY, VRTÁKY	DRILLS, BURS	
131 09 1200	Fréza trepanační kulová; 4 mm	Bone cutter; 4 mm	375
131 09 1210	Fréza trepanační kulová; 8 mm	Bone cutter; 8 mm	375
131 09 1220	Fréza trepanační kulová; 12 mm	Bone cutter; 12 mm	375
131 09 1230	Fréza trepanační kulová; 15 mm	Bone cutter; 15 mm	375
131 09 1351	Vrtačka kolovrátková	Hand drill	375
131 17 0280	Fréza trepanační čtyřbřitá válcová; 9 mm	Cylindrical cutter four-edged; 9 mm	375
131 17 0290	Fréza trepanační čtyřbřitá válcová; 10 mm	Cylindrical cutter four-edged; 10 mm	375
131 17 0300	Fréza trepanační čtyřbřitá válcová; 11 mm	Cylindrical cutter four-edged; 11 mm	375
131 17 0310	Fréza trepanační čtyřbřitá válcová; 12 mm	Cylindrical cutter four-edged; 12 mm	375
131 17 0320	Fréza trepanační čtyřbřitá válcová; 13 mm	Cylindrical cutter four-edged; 13 mm	375
131 29 0010	Fréza pro orl kulová s podélnými břity fig.1; 3,0 mm	Ent burr-drill spher fig.1; 3,0 mm	376
131 29 0020	Fréza pro orl kulová s podélnými břity fig.2; 3,5 mm	Ent burr-drill spher fig.2; 3,5 mm	376
131 29 0030	Fréza pro orl kulová s podélnými břity fig.3; 4,0 mm	Ent burr-drill spher fig.3; 4,0 mm	376
131 29 0040	Fréza pro orl kulová s podélnými břity fig.4; 4,5 mm	Ent burr-drill spher fig.4; 4,5 mm	376
131 29 0050	Fréza pro orl kulová s podélnými břity fig.5; 5,0 mm	Ent burr-drill spher fig.5; 5,0 mm	376
131 29 0100	Fréza pro orl hruškovitá zploštělá s podél. břity fig.1	Ent burr-drill pear-shaped fig.1	376
131 29 0120	Fréza pro orl hruškovitá zploštělá s podél. břity fig.3	Ent burr-drill pear-shaped fig.3	376
131 29 0200	Fréza pro orl hruškovitá zploštělá s kříž. břity fig.1	Ent burr-drill pear-shaped fig.1	376
131 29 0450	Fréza pro orl kulová fig.10; 2,7 mm	Ent burr-drill spher fig.10; 2,7 mm	376
131 29 0460	Fréza pro orl kulová fig.12; 3,1 mm	Ent burr-drill spher fig.12; 3,1 mm	376
131 29 0470	Fréza pro orl kulová fig.14; 3,5 mm	Ent burr-drill spher fig.14; 3,5 mm	376
132	JEHLY, JEHELCE	NEEDLES, NEEDLE HOLDERS	
132 01 0050	Jehla šicí pitevni; 3 mm; 10,7 cm	Post mortem suturing needle; 3 mm; 10,7 cm	399
132 02 0220	Jehla šicí; 1,1×56 mm	Suturing needle; 1,1×56 mm	451
132 02 0401	Jehla šicí; 1,4×60 mm	Suturing needle; 1,4×60 mm	451
132 02 0406	Jehla šicí; 1,2×35 mm	Suturing needle; 1,2×35 mm	451
132 02 0700	Jehla šicí; 0,8×65 mm	Suturing needle; 0,8×65 mm	451
132 06 0010	Deschamps jehla podvazovací pravá ostrá fig.1	Deschamps ligature needle fig.1	398
132 06 0020	Deschamps jehla podvazovací levá ostrá fig.1	Deschamps ligature needle fig.1	398
132 06 0030	Deschamps jehla podvazovací pravá tupá fig.1	Deschamps ligature needle fig.1	398

číslo – number	název	item	strana – page
132 06 0040	Deschamps jehla podvazovací levá tupá fig.1	Deschamps ligature needle fig.1	398
132 06 0050	Deschamps jehla podvazovací pravá ostrá fig.2	Deschamps ligature needle fig.2	398
132 06 0060	Deschamps jehla podvazovací levá ostrá fig.2	Deschamps ligature needle fig.2	398
132 06 0070	Deschamps jehla podvazovací pravá tupá fig.2	Deschamps ligature needle fig.2	398
132 06 0080	Deschamps jehla podvazovací levá tupá fig.2	Deschamps ligature needle fig.2	398
132 06 0090	Deschamps jehla podvazovací pravá ostrá fig.3	Deschamps ligature needle fig.3	398
132 06 0100	Deschamps jehla podvazovací levá ostrá fig.3	Deschamps ligature needle fig.3	398
132 06 0110	Deschamps jehla podvazovací pravá tupá fig.3	Deschamps ligature needle fig.3	398
132 06 0120	Deschamps jehla podvazovací levá tupá fig.3	Deschamps ligature needle fig.3	398
132 06 0200	Mathieu jehlec bez drážky; 14,0 cm	Mathieu needle holder; 14,0 cm	381
132 06 0220	Mathieu jehlec bez drážky; 17,0 cm	Mathieu needle holder; 17,0 cm	381, 451
132 06 0300	Crile jehlec jemný; 15,0 cm	Crile needle holder; 15,0 cm	381
132 06 0310	Crile jehlec jemný; 15,5 cm	Crile needle holder; 15,5 cm	381
132 06 0341	Jehlec hloubkový rovný provlékací zámek; 16,5 cm	Needle holder; 16,5 cm	381
132 06 0370	Crile jehlec jemný diamantovaný; 1,6 mm; 15,5 cm	Crile needle holder dia; 1,6 mm; 15,5 cm	389
132 06 0450	Crile jehlec jemný provlékací zámek (vloška sk); 16,2 cm	Crile needle holder TUC; 16,2 cm	389
132 06 0500	Mathieu jehlec provlékací zámek (vloška sk); 17,0 cm	Mathieu needle holder TUC; 17,0 cm	388
132 06 0510	Mathieu jehlec provlékací zámek (vloška sk); 21,5 cm	Mathieu needle holder TUC; 21,5 cm	388
132 06 0520	Mathieu jehlec provlékací zámek (vloška sk); 14,0 cm	Mathieu needle holder TUC; 14,0 cm	388
132 06 0590	Jehlec jemný rovný tvrdokov; 13,0 cm	Needle holder TUC; 13,0 cm	382
132 06 0600	Ryder/French-Eye jehlec tvrdokov; 16,5 cm	Ryder/French-Eye needle holder; 16,5 cm	384
132 06 0610	Jehlec hloubkový rovný tvrdokov; 16,5 cm	Needle holder TUC; 16,5 cm	382
132 06 0620	Jehlec hloubkový rovný tvrdokov; 20,5 cm	Needle holder TUC; 20,5 cm	382
132 06 0630	Jehlec hloubkový rovný tvrdokov; 25,5 cm	Needle holder TUC; 25,5 cm	382
132 06 0640	Ryder/French-Eye jehlec tvrdokov; 20,5 cm	Ryder/French-Eye needle holder; 20,5 cm	384
132 06 0650	Ryder/French-Eye jehlec tvrdokov; 25,5 cm	Ryder/French-Eye needle holder; 25,5 cm	384
132 06 0710	Bozemann jehlec hloubk. prohnutý tvrdokov; 16,0 cm	Needle holder TUC; 16,0 cm	387
132 06 0720	Bozemann jehlec hloubk. prohnutý tvrdokov; 20,0 cm	Needle holder TUC; 20,0 cm	387
132 06 0730	Bozemann jehlec hloubk. prohnutý tvrdokov; 25,0 cm	Needle holder TUC; 25,0 cm	387
132 06 0740	Jehlec hloubkový prohnutý diamant; 20,0 cm	Needle holder; 20,0 cm	387
132 06 0810	Jehlec s vnitřním uzávěrem vroubkovaným; 20,5 cm	Needle holder; 20,5 cm	381
132 06 0830	Jehlec s vnitřním uzávěrem tvrdokov; 20,5 cm	Needle holder TUC; 20,5 cm	389
132 08 0500	Redonova jehla; 8 Ch; 16,0 cm	Redon needle; 8 Ch; 16,0 cm	416
132 08 0510	Redonova jehla; 9 Ch; 16,0 cm	Redon needle; 9 Ch; 16,0 cm	416
132 08 0520	Redonova jehla; 10 Ch; 16,0 cm	Redon needle; 10 Ch; 16,0 cm	416
132 12 0011	Jehlec pro plastiku prohnutý; 16,2 cm	Needle holder for plastic surgery; 16,2 cm	396
132 12 0020	Jehlec pro plastiku prohnutý; 21,0 cm	Needle holder for plastic surgery; 21,0 cm	396
132 17 0021	Jehlec neurochirurgický; 13,0 cm	Neurosurgical needle holder; 13,0 cm	396
132 17 0030	Jehlec neurochirurgický; 17,0 cm	Neurosurgical needle holder; 17,0 cm	396
132 32 0100	Durham jehla podvazovací na patro pravá; 24,6 cm	Durham ligature needle; 24,6 cm	399
132 32 0110	Durham jehla podvazovací na patro levá; 24,6 cm	Durham ligature needle; 24,6 cm	399
132 38 0120	Boynton jehlec oční; 12,5 cm	Boynton eye needle holder; 12,5 cm	379
132 38 0210	Jehlec oční pružinový mikro rovný; 11,5 cm	Micro-needle holder; 11,5 cm	379
132 38 0220	Jehlec oční pružinový mikro zahnutý; 11,5 cm	Micro-needle holder; 11,5 cm	379
132 38 0230	Jehlec oční pružinový rovný; 11,5 cm	Needle holder; 11,5 cm	379
132 38 0240	Jehlec oční pružinový zahnutý; 11,5 cm	Needle holder; 11,5 cm	379
132 38 0250	Fillatoff rámeček na víčkové stehy; 14,4×9,0 mm	Fillatoff frame for eye ligature; 14,4×9,0 mm	379
132 91 0030	Mayo-Hegar jehlec; 14,0 cm	Mayo-Hegar needle holder; 14,0 cm	380
132 91 0031	Mayo-Hegar jehlec; 16,0 cm	Mayo-Hegar needle holder; 16,0 cm	380
132 91 0032	Mayo-Hegar jehlec; 18,0 cm	Mayo-Hegar needle holder; 18,0 cm	380
132 91 0033	Mayo-Hegar jehlec; 20,0 cm	Mayo-Hegar needle holder; 20,0 cm	380
132 91 0034	Mayo-Hegar jehlec; 24,0 cm	Mayo-Hegar needle holder; 24,0 cm	380
132 91 0035	Mayo-Hegar jehlec; 26,0 cm	Mayo-Hegar needle holder; 26,0 cm	380
132 91 0036	Mayo-Hegar jehlec; 30,0 cm	Mayo-Hegar needle holder; 30,0 cm	380
132 91 0037	Mayo-Hegar-Delicate jehlec; 16,0 cm	Mayo-Hegar-Delicate needle holder; 16,0 cm	380
132 91 0038	Mayo-Hegar-Delicate jehlec; 18,0 cm	Mayo-Hegar-Delicate needle holder; 18,0 cm	380
132 91 0039	Mayo-Hegar-Delicate jehlec; 20,0 cm	Mayo-Hegar-Delicate needle holder; 20,0 cm	380
132 91 0040	Heaney jehlec zahnutý; 21,0 cm	Heaney needle holder; 21,0 cm	380
132 91 0050	Olsen-Hegar jehlec/nůžky; 14,0 cm	Olsen-Hegar needle holder/scissors; 14,0 cm	380
132 91 0051	Olsen-Hegar jehlec/nůžky; 17,0 cm	Olsen-Hegar needle holder/scissors; 17,0 cm	380
132 91 0052	Olsen-Hegar jehlec/nůžky; 19,0 cm	Olsen-Hegar needle holder/scissors; 19,0 cm	380
132 91 0056	Mathieu jehlec; 20,0 cm	Mathieu needle holder; 20,0 cm	381
132 91 0057	Mathieu jehlec; 24,0 cm	Mathieu needle holder; 24,0 cm	381
132 91 0096	Mayo-Hegar jehlec tvrdokov; 14,0 cm	Mayo-Hegar needle holder TUC; 14,0 cm	383
132 91 0097	Mayo-Hegar jehlec tvrdokov; 16,0 cm	Mayo-Hegar needle holder TUC; 16,0 cm	383
132 91 0098	Mayo-Hegar jehlec tvrdokov; 18,0 cm	Mayo-Hegar needle holder TUC; 18,0 cm	383
132 91 0099	Mayo-Hegar jehlec tvrdokov; 20,0 cm	Mayo-Hegar needle holder TUC; 20,0 cm	383
132 91 0100	Mayo-Hegar jehlec tvrdokov; 24,0 cm	Mayo-Hegar needle holder TUC; 24,0 cm	383
132 91 0101	Mayo-Hegar jehlec tvrdokov; 26,0 cm	Mayo-Hegar needle holder TUC; 26,0 cm	383
132 91 0102	Mayo-Hegar jehlec tvrdokov; 30,0 cm	Mayo-Hegar needle holder TUC; 30,0 cm	383
132 91 0103	De Bakey jehlec tvrdokov; 18,0 cm	De Bakey needle holder TUC; 18,0 cm	383

číslo – number	název	item	strana – page
132 91 0104	De Bakey jehelec tvrdokov; 20,0 cm	De Bakey needle holder TUC; 20,0 cm	383
132 91 0105	De Bakey jehelec tvrdokov; 23,0 cm	De Bakey needle holder TUC; 23,0 cm	383
132 91 0106	De Bakey jehelec tvrdokov; 26,0 cm	De Bakey needle holder TUC; 26,0 cm	383
132 91 0107	De Bakey jehelec tvrdokov; 31,0 cm	De Bakey needle holder TUC; 31,0 cm	383
132 91 0108	Ryder/French-Eye jehelec oční tvrdokov; 13,0 cm	Ryder/French-Eye needle holder TUC; 13,0 cm	384
132 91 0120	Euftrate Pasque jehelec tvrdokov; 14,0 cm	Euftrate Pasque needle holder TUC; 14,0 cm	384
132 91 0121	Euftrate Pasque jehelec tvrdokov; 18,0 cm	Euftrate Pasque needle holder TUC; 18,0 cm	384
132 91 0122	Euftrate Pasque jehelec tvrdokov; 20,0 cm	Euftrate Pasque needle holder TUC; 20,0 cm	384
132 91 0123	Euftrate Pasque jehelec tvrdokov; 23,0 cm	Euftrate Pasque needle holder TUC; 23,0 cm	384
132 91 0124	Microvascular jehelec tvrdokov; 14,0 cm	Microvascular needle holder TUC; 14,0 cm	384
132 91 0125	Microvascular jehelec tvrdokov; 18,0 cm	Microvascular needle holder TUC; 18,0 cm	384
132 91 0126	Microvascular jehelec tvrdokov; 20,0 cm	Microvascular needle holder TUC; 20,0 cm	384
132 91 0127	Microvascular jehelec tvrdokov; 23,0 cm	Microvascular needle holder TUC; 23,0 cm	384
132 91 0130	New Orleans jehelec tvrdokov; 18,0 cm	New Orleans needle holder TUC; 18,0 cm	385
132 91 0131	Senning (Swed. Mod) jehelec tvrdokov; 15,0 cm	Senning needle holder TUC; 15,0 cm	385
132 91 0132	Senning (Swed. Mod) jehelec tvrdokov; 17,0 cm	Senning needle holder TUC; 17,0 cm	385
132 91 0133	Derf jehelec tvrdokov; 12,5 cm	Derf needle holder TUC; 12,5 cm	385
132 91 0135	Kilner jehelec s-prohnutý tvrdokov; 13,5 cm	Kilner needle holder TUC; 13,5 cm	385
132 91 0137	Webster jehelec tvrdokov; 13,0 cm	Webster needle holder TUC; 13,0 cm	386
132 91 0138	Halsey jehelec tvrdokov hladký; 13,0 cm	Halsey needle holder TUC; 13,0 cm	386
132 91 0139	Halsey jehelec tvrdokov; 13,0 cm	Halsey needle holder TUC; 13,0 cm	386
132 91 0140	Baby-Crile-Wood jehelec tvrdokov; 15,0 cm	Baby-Crile-Wood needle holder TUC; 15,0 cm	386
132 91 0142	Crile-Wood jehelec tvrdokov; 15,0 cm	Crile-Wood needle holder TUC; 15,0 cm	386
132 91 0143	Crile-Wood jehelec tvrdokov; 18,0 cm	Crile-Wood needle holder TUC; 18,0 cm	386
132 91 0144	Crile-Wood jehelec tvrdokov; 20,0 cm	Crile-Wood needle holder TUC; 20,0 cm	386
132 91 0145	Crile-Wood jehelec tvrdokov; 23,0 cm	Crile-Wood needle holder TUC; 23,0 cm	386
132 91 0148	Finocchietto jehelec tvrdokov; 27,0 cm	Finocchietto needle holder TUC; 27,0 cm	387
132 91 0149	Wangensteen jehelec tvrdokov; 27,0 cm	Wangensteen needle holder TUC; 27,0 cm	387
132 91 0154	Sarot jehelec tvrdokov; 18,0 cm	Sarot needle holder TUC; 18,0 cm	387
132 91 0155	Sarot jehelec tvrdokov; 26,0 cm	Sarot needle holder TUC; 26,0 cm	387
132 91 0156	Masson jehelec tvrdokov; 27,0 cm	Masson needle holder TUC; 27,0 cm	387
132 91 0160	Olsen-Hegar jehelec/nůžky tvrdokov; 14,0 cm	Olsen-Hegar needle holder/scs. Tuc; 14,0 cm	388
132 91 0161	Olsen-Hegar jehelec/nůžky tvrdokov; 17,0 cm	Olsen-Hegar needle holder/scs. Tuc; 17,0 cm	388
132 91 0162	Olsen-Hegar jehelec/nůžky tvrdokov; 19,0 cm	Olsen-Hegar needle holder/scs. Tuc; 19,0 cm	388
132 91 0167	Mathieu jehelec tvrdokov; 24,0 cm	Mathieu needle holder TUC; 24,0 cm	388
132 91 0168	Mathieu jehelec jemný tvrdokov; 17,0 cm	Mathieu needle holder TUC; 17,0 cm	388
132 91 0169	Mathieu jehelec jemný tvrdokov; 20,0 cm	Mathieu needle holder TUC; 20,0 cm	388
132 91 0170	Mathieu jehelec jemný tvrdokov; 23,0 cm	Mathieu needle holder TUC; 23,0 cm	388
132 91 0174	Metzenbaum jehelec zahnutý tvrdokov; 17,0 cm	Metzenbaum needle holder TUC; 17,0 cm	389
132 91 0175	Metzenbaum jehelec zahnutý tvrdokov; 19,5 cm	Metzenbaum needle holder TUC; 19,5 cm	389
132 91 0176	Mathieu-Ryder jehelec tvrdokov; 17,0 cm	Mathieu-Ryder needle holder TUC; 17,0 cm	389
132 91 0177	Mathieu-Ryder jehelec tvrdokov; 20,0 cm	Mathieu-Ryder needle holder TUC; 20,0 cm	389
132 91 0182	Boynton jehelec oční tvrdokov; 12,5 cm	Boynton eye needle holder; 12,5 cm	390
132 91 0186	Hösel jehelec tvrdokov; 25,0 cm	Hoesel needle holder TUC; 25,0 cm	390
132 91 0192	Luethy-Beck jehelec tvrdokov; 20,0 cm	Luethy-Beck needle holder TUC; 20,0 cm	390
132 91 0194	Langenbeck jehelec tvrdokov; 18,0 cm	Langenbeck needle holder TUC; 18,0 cm	390
132 91 0195	Langenbeck jehelec tvrdokov; 20,0 cm	Langenbeck needle holder TUC; 20,0 cm	390
132 91 0196	Langenbeck-Delicate jehelec tvrdokov; 18,0 cm	Langenbeck-Delicate needle holder TUC; 18,0 cm	390
132 91 0197	Langenbeck-Delicate jehelec tvrdokov; 20,0 cm	Langenbeck-Delicate needle holder TUC; 20,0 cm	390
132 91 0199	Langenbeck-Ryder jehelec tvrdokov; 18,0 cm	Langenbeck-Ryder needle holder TUC; 18,0 cm	390
132 91 0200	Langenbeck-Ryder jehelec tvrdokov; 20,0 cm	Langenbeck-Ryder needle holder TUC; 20,0 cm	390
132 91 0202	Sternum jehelec tvrdokov; 13,0 cm	Sternum needle holder TUC; 13,0 cm	391
132 91 0203	Sternum jehelec tvrdokov; 18,0 cm	Sternum needle holder TUC; 18,0 cm	391
132 91 0206	Berry jehelec tvrdokov; 18,5 cm	Berry wire twisting forceps TUC; 18,5 cm	391
132 91 0213	Castroviejo jehelec rovný hladký tvrdokov; 14,0 cm	Castroviejo needle holder TUC; 14,0 cm	391
132 91 0214	Castroviejo jehelec zahnutý hladký tvrdokov; 14,0 cm	Castroviejo needle holder TUC; 14,0 cm	391
132 91 0215	Castroviejo jehelec rovný vroubkovaný tvrdokov; 14,0 cm	Castroviejo needle holder TUC; 14,0 cm	391
132 91 0216	Castroviejo jehelec zahnutý vroubkovaný tvrdokov; 14,0 cm	Castroviejo needle holder TUC; 14,0 cm	391
132 91 0217	Castroviejo jehelec rovný hladký tvrdokov; 18,0 cm	Castroviejo micro-needle holder TUC; 18,0 cm	392
132 91 0218	Castroviejo jehelec zahnutý hladký tvrdokov; 18,0 cm	Castroviejo micro-needle holder TUC; 18,0 cm	392
132 91 0219	Castroviejo jehelec rovný vroubkovaný tvrdokov; 18,0 cm	Castroviejo micro-needle holder TUC; 18,0 cm	392
132 91 0220	Castroviejo jehelec zahnutý vroubkovaný tvrdokov; 18,0 cm	Castroviejo micro-needle holder TUC; 18,0 cm	392
132 91 0221	Jacobson jehelec mikro hladký tvrdokov; 21,0 cm	Jacobson micro-needle holder TUC; 21,0 cm	392
132 91 0222	Jacobson jehelec mikro vroubkovaný tvrdokov; 21,0 cm	Jacobson micro-needle holder TUC; 21,0 cm	392
132 91 0223	Diethrich jehelec mikro tvrdokov; 16,0 cm	Diethrich micro-needle holder TUC; 16,0 cm	392
132 91 0224	Diethrich jehelec mikro tvrdokov; 18,0 cm	Diethrich micro-needle holder TUC; 18,0 cm	392
132 91 0225	Diethrich jehelec mikro tvrdokov; 20,0 cm	Diethrich micro-needle holder TUC; 20,0 cm	392
132 91 0226	Diethrich jehelec mikro tvrdokov; 23,0 cm	Diethrich micro-needle holder TUC; 23,0 cm	392
132 91 0227	Diethrich jehelec mikro tvrdokov; 26,0 cm	Diethrich micro-needle holder TUC; 26,0 cm	392
132 91 0229	Castroviejo jehelec mikro hladký tvrdokov; 13,0 cm	Castroviejo needle holder TUC; 13,0 cm	392
132 91 0230	Potts-Smith jehelec mikro tvrdokov; 22,0 cm	Potts-Smith micro-needle holder TUC; 22,0 cm	392

číslo – number	název	item	strana – page
132 91 0249	Barraquer jehlec mikro rovný; 18,0 cm	Barraquer micro-needle holder; 18,0 cm	393
132 91 0250	Barraquer jehlec mikro zahnutý; 18,0 cm	Barraquer micro-needle holder; 18,0 cm	393
132 91 0251	Barraquer jehlec mikro rovný s uzávěrem; 18,0 cm	Barraquer micro-needle holder; 18,0 cm	393
132 91 0252	Barraquer jehlec mikro zahnutý s uzávěrem; 18,0 cm	Barraquer micro-needle holder; 18,0 cm	393
132 91 0253	Castroviejo jehlec mikro rovný; 9,0 cm	Castroviejo micro-needle holder; 9,0 cm	394
132 91 0254	Castroviejo jehlec mikro zahnutý; 9,0 cm	Castroviejo micro-needle holder; 9,0 cm	394
132 91 0255	Castroviejo jehlec mikro rovný s uzávěrem; 9,0 cm	Castroviejo micro-needle holder; 9,0 cm	394
132 91 0256	Castroviejo jehlec mikro zahnutý s uzávěrem; 9,0 cm	Castroviejo micro-needle holder; 9,0 cm	394
132 91 0257	Castroviejo jehlec mikro rovný hladký; 14,0 cm	Castroviejo micro-needle holder; 14,0 cm	394
132 91 0258	Castroviejo jehlec mikro zahnutý hladký; 14,0 cm	Castroviejo micro-needle holder; 14,0 cm	394
132 91 0259	Castroviejo jehlec mikro rovný vroubkovaný; 14,0 cm	Castroviejo micro-needle holder; 14,0 cm	394
132 91 0260	Castroviejo jehlec mikro zahnutý vroubkovaný; 14,0 cm	Castroviejo micro-needle holder; 14,0 cm	394
132 91 0261	Castroviejo jehlec rovný hladký s uzávěrem; 14,0 cm	Castroviejo micro-needle holder; 14,0 cm	394
132 91 0262	Castroviejo jehlec zahnutý hladký s uzávěrem; 14,0 cm	Castroviejo micro-needle holder; 14,0 cm	394
132 91 0263	Castroviejo jehlec rovný vroubk. s uzávěrem; 14,0 cm	Castroviejo micro-needle holder; 14,0 cm	394
132 91 0264	Castroviejo jehlec zahnutý vroubk. s uzávěrem; 14,0 cm	Castroviejo micro-needle holder; 14,0 cm	394
132 91 0269	Jacobson jehlec mikro s uzávěrem; 18,0 cm	Jacobson micro-needle holder; 18,0 cm	394
132 91 0270	Jacobson jehlec mikro s uzávěrem; 21,0 cm	Jacobson micro-needle holder; 21,0 cm	394
132 91 0271	Jehlec mikro rovný bajonetový; 16,5 cm	Micro-needle holder; 16,5 cm	395
132 91 0272	Jehlec mikro rovný bajonetový; 18,0 cm	Micro-needle holder; 18,0 cm	395
132 91 0273	Jehlec mikro rovný bajonetový; 20,0 cm	Micro-needle holder; 20,0 cm	395
132 91 0274	Jehlec mikro rovný bajonetový; 22,0 cm	Micro-needle holder; 22,0 cm	395
132 91 0275	Jehlec mikro zahnutý bajonetový; 16,5 cm	Micro-needle holder; 16,5 cm	395
132 91 0276	Jehlec mikro zahnutý bajonetový; 18,0 cm	Micro-needle holder; 18,0 cm	395
132 91 0277	Jehlec mikro zahnutý bajonetový; 20,0 cm	Micro-needle holder; 20,0 cm	395
132 91 0278	Jehlec mikro zahnutý bajonetový; 22,0 cm	Micro-needle holder; 22,0 cm	395
132 91 0297	Reverdin jehla fig.1; 14,0 cm	Reverdin needle fig.1; 14,0 cm	397
132 91 0298	Reverdin jehla fig.2; 14,0 cm	Reverdin needle fig.2; 14,0 cm	397
132 91 0299	Reverdin jehla fig.3; 14,0 cm	Reverdin needle fig.3; 14,0 cm	397
132 91 0300	Reverdin jehla fig.4; 14,0 cm	Reverdin needle fig.4; 14,0 cm	397
132 91 0301	Reverdin jehla fig.1; 19,5 cm	Reverdin needle fig.1; 19,5 cm	397
132 91 0302	Reverdin jehla fig.2; 19,5 cm	Reverdin needle fig.2; 19,5 cm	397
132 91 0303	Reverdin jehla fig.3; 19,5 cm	Reverdin needle fig.3; 19,5 cm	397
132 91 0304	Reverdin jehla fig.4; 19,5 cm	Reverdin needle fig.4; 19,5 cm	397
132 91 0305	Reverdin jehla fig.1; 22,5 cm	Reverdin needle fig.1; 22,5 cm	397
132 91 0306	Reverdin jehla fig.2; 22,5 cm	Reverdin needle fig.2; 22,5 cm	397
132 91 0307	Reverdin jehla fig.3; 22,5 cm	Reverdin needle fig.3; 22,5 cm	397
132 91 0308	Reverdin jehla fig.4; 22,5 cm	Reverdin needle fig.4; 22,5 cm	397
132 91 0311	Deschamps jehla levá ostrá střední; 20,0 cm	Deschamps ligature needle; 20,0 cm	398
132 91 0312	Deschamps jehla pravá ostrá střední; 20,0 cm	Deschamps ligature needle; 20,0 cm	398
132 91 0319	Deschamps jehla levá tupá střední; 20,0 cm	Deschamps ligature needle; 20,0 cm	398
132 91 0320	Deschamps jehla pravá tupá střední; 20,0 cm	Deschamps ligature needle; 20,0 cm	398
132 91 0353	Brunner jehla podvazovací fig.1; 30,0 cm	Brunner ligature needle fig.1; 30,0 cm	399
132 91 0354	Brunner jehla podvazovací fig.2; 30,0 cm	Brunner ligature needle fig.1; 30,0 cm	399
132 91 0358	Payr jehla podvazovací rovná; 22,0 cm	Payr ligature needle; 22,0 cm	400
132 91 0359	Payr jehla podvazovací zahnutý; 22,0 cm	Payr ligature needle; 22,0 cm	400
132 91 0360	Schmieden-Payr jehla podvazovací fig.1; 19,0 cm	Schmieden-Payr ligature needle; 19,0 cm	400
132 91 0361	Schmieden-Payr jehla podvazovací fig.2; 19,0 cm	Schmieden-Payr ligature needle; 19,0 cm	400
132 91 0362	König jehla podvazovací; 3 mm; 19,5 cm	König ligature needle; 3 mm; 19,5 cm	400
132 91 0363	König jehla podvazovací; 5 mm; 19,5 cm	König ligature needle; 5 mm; 19,5 cm	400
132 91 0364	König jehla podvazovací; 7 mm; 19,5 cm	König ligature needle; 7 mm; 19,5 cm	400
132 91 0365	Kirschner jehla podvazovací; 25,5 cm	Kirschner ligature needle; 25,5 cm	399
132 91 0366	Kirschner jehla podvazovací; 28,0 cm	Kirschner ligature needle; 28,0 cm	399
132 91 0382	Michel svorka šicí; 12,0 cm	Michel clip forceps; 12,0 cm	401
132 91 0383	Collin svorka šicí; 13,0 cm	Collin clip forceps; 13,0 cm	401
132 91 0386	Hegenbarth pinzeta šicí; 12,5 cm	Hegenbarth suture forceps; 12,5 cm	401
132 91 0387	Michel pinzeta šicí; 12,0 cm	Michel suture forceps; 12,0 cm	401
132 91 0391	Michel svorka šicí; 10 balení = 1000 ks; 7,5×1,75 mm	Michel clips; 10 × 100 pcs; 7,5×1,75 mm	401
132 91 0392	Michel svorka šicí; 10 balení = 1000 ks; 11,0×2,5 mm	Michel clips; 10 × 100 pcs; 11,0×2,5 mm	401
132 91 0393	Michel svorka šicí; 10 balení = 1000 ks; 12,0×3,0 mm	Michel clips; 10 × 100 pcs; 12,0×3,0 mm	401
132 91 0394	Michel svorka šicí; 10 balení = 1000 ks; 14,0×3,0 mm	Michel clips; 10 × 100 pcs; 14,0×3,0 mm	401
132 91 0395	Michel svorka šicí; 10 balení = 1000 ks; 16,0×3,0 mm	Michel clips; 10 × 100 pcs; 16,0×3,0 mm	401
132 91 0396	Michel svorka šicí; 10 balení = 1000 ks; 18,0×3,0 mm	Michel clips; 10 × 100 pcs; 18,0×3,0 mm	401
132 91 0397	Michel svorka šicí; 10 balení = 1000 ks; 20,0×3,0 mm	Michel clips; 10 × 100 pcs; 20,0×3,0 mm	401
132 91 0398	Michel svorka šicí; 10 balení = 1000 ks; 22,0×3,0 mm	Michel clips; 10 × 100 pcs; 22,0×3,0 mm	401
132 91 0399	Finocchietto jehlec; 20,0 cm	Finocchietto needle holder; 20,0 cm	387
132 91 0400	V. Petz břišní a střevní sešívací aparát	V. Petz stomach and intestinal suturing apparatus	402
132 91 0413	Petz svorka šicí; balení = 300 ks	Petz clips; 300 pcs	402
133	PÁTRADLA	PROBES	
133 03 0020	Jehla na odběr kostní dřeně; 5 mm; 19,8 cm	Bone marrow extraction needles; 5 mm; 19,8 cm	405
133 03 0030	Jehla na odběr kostní dřeně; 4 mm; 19,8 cm	Bone marrow extraction needles; 4 mm; 19,8 cm	405

číslo – number	název	item	strana – page
133 08 0020	Pátradlo paličkové oboustranné; 15,0 cm	Probe olive; 15,0 cm	405
133 08 0050	Pátradlo paličkové oboustranné; 20,0 cm	Probe olive; 20,0 cm	405
133 08 0060	Pátradlo paličkové oboustranné; 25,0 cm	Probe olive; 25,0 cm	405
133 08 0090	Pátradlo žlábkové; 13,6 cm	Probe; 13,6 cm	405, 451
133 08 0100	Pátradlo paličkové s dlátkem; 15,0 cm	Probe olive with chisel; 15,0 cm	405, 441
133 08 0110	Pátradlo paličkové s dlátkem; 20,0 cm	Probe olive with chisel; 20,0 cm	405
133 08 0120	Pátradlo paličkové s dlátkem; 25,0 cm	Probe olive with chisel; 25,0 cm	405
133 08 0140	Pátradlo paličkové; 14,5 cm	Probe; 14,5 cm	405
133 17 0061	Zavaděč drátěných pilek	Conductor for wire saws	362
133 17 0070	Zavaděč drátěných pilek	Conductor for wire saws	362
133 20 0010	Desjardines pátradlo na žlučovod; 4 mm; 27,0 cm	Desjardines gall duct probe; 4 mm; 27,0 cm	406
133 20 0020	Desjardines pátradlo na žlučovod; 5 mm; 27,0 cm	Desjardines gall duct probe; 5 mm; 27,0 cm	406
133 20 0030	Desjardines pátradlo na žlučovod; 6 mm; 27,0 cm	Desjardines gall duct probe; 6 mm; 27,0 cm	406
133 20 0040	Desjardines, sada pátradel na žlučovod	Desjardines gall duct probes set	406
133 20 0050	Bakeš sada pátradel na žlučovod	Bakeš gall duct probes set	407
133 20 0070	Bakeš pátradlo na žlučovod; 2,5 mm; 17,0 cm	Bakeš gall duct probe; 2,5 mm; 17,0 cm	407
133 20 0080	Bakeš pátradlo na žlučovod; 3,0 mm; 18,0 cm	Bakeš gall duct probe; 3,0 mm; 18,0 cm	407
133 20 0090	Bakeš pátradlo na žlučovod; 4,0 mm; 17,3 cm	Bakeš gall duct probe; 4,0 mm; 17,3 cm	407
133 20 0100	Bakeš pátradlo na žlučovod; 5,0 mm; 21,5 cm	Bakeš gall duct probe; 5,0 mm; 21,5 cm	407
133 20 0110	Bakeš pátradlo na žlučovod; 6,0 mm; 22,8 cm	Bakeš gall duct probe; 6,0 mm; 22,8 cm	407
133 20 0120	Bakeš pátradlo na žlučovod; 7,0 mm; 19,0 cm	Bakeš gall duct probe; 7,0 mm; 19,0 cm	407
133 20 0130	Bakeš pátradlo na žlučovod; 8,0 mm; 24,0 cm	Bakeš gall duct probe; 8,0 mm; 24,0 cm	407
133 20 0140	Bakeš pátradlo na žlučovod; 9,0 mm; 25,2 cm	Bakeš gall duct probe; 9,0 mm; 25,2 cm	407
133 20 0400	Elektroda kuličková izolovaná; 4,3 mm; 33,0 cm	Electrode; 4,3 mm; 33,0 cm	409
133 20 0410	Elektroda kuličková izolovaná; 2,0 mm; 33,0 cm	Electrode; 2,0 mm; 33,0 cm	409
133 20 0420	Elektroda lopátková izolovaná; 2,8 mm; 33,0 cm	Electrode; 2,8 mm; 33,0 cm	409
133 20 0430	Elektroda háčková izolovaná; 33,0 cm	Electrode; 33,0 cm	409
133 20 0440	Elektroda háčková s ostřím izolovaná; 33,0 cm	Electrode; 33,0 cm	409
133 22 0170	Sonda urolog. s olivkami oboustr.; 12-14-18-16 ch; 19,6 cm	Urological probe with olives; 12-14-18-16 ch; 19,6 cm	410
133 22 0180	Sonda urolog. s olivkami oboustr.; 20-22-26-24 ch; 19,6 cm	Urological probe with olives; 20-22-26-24 ch; 19,6 cm	410
133 22 0190	Sonda urolog. s olivkami oboustr.; 14-16-20-18 ch; 20,6 cm	Urological probe with olives; 14-16-20-18 ch; 20,6 cm	410
133 22 0200	Sonda urolog. s olivkami oboustr.; 22-24-28-26 ch; 20,6 cm	Urological probe with olives; 22-24-28-26 ch; 20,6 cm	410
133 27 0011	Sims pátradlo děložní; 3,5 mm; 36,5 cm	Sims uterine probe; 3,5 mm; 36,5 cm	409
133 27 0130	Pátradlo děložní jemné; 2,4 mm; 28,0 cm	Uterine probe; 2,4 mm; 28,0 cm	409
133 29 0010	Pátradlo ušní; 1,0 mm; 9,5 cm	Aural probe; 1,0 mm; 9,5 cm	411
133 29 0110	Drátek pro výtěry; 0,8 mm; 14,0 cm	Swab wire; 0,8 mm; 14,0 cm	411
133 30 0030	Pátradlo nosní; 1,6 mm; 13,7 cm	Nasal probe; 1,6 mm; 13,7 cm	411
133 35 0010	Kocher pátradlo na strumu; 15,5 cm	Kocher goitre probe; 15,5 cm	411
133 38 0060	Bowmann pátradlo oční nerez; 0,5 mm; 13,0 cm	Bowmann eye probe; 0,5 mm; 13,0 cm	411
133 38 0070	Bowmann pátradlo oční nerez; 0,7 mm; 13,0 cm	Bowmann eye probe; 0,7 mm; 13,0 cm	411
133 38 0080	Bowmann pátradlo oční nerez; 0,9 mm; 13,0 cm	Bowmann eye probe; 0,9 mm; 13,0 cm	411
133 38 0110	Dilatátor slzných bodů; 0,1 mm; 7,5 cm	Eye dilator; 0,1 mm; 7,5 cm	412
133 38 0120	Dilatátor slzných bodů; 0,25 mm; 7,5 cm	Eye dilator; 0,25 mm; 7,5 cm	412
133 38 0130	Dilatátor slzných bodů; 0,4 mm; 7,5 cm	Eye dilator; 0,4 mm; 7,5 cm	412
133 38 0200	Sonda oční dutá; 0,5 mm; 10,0 cm	Eye probe; 0,5 mm; 10,0 cm	412
133 38 0210	Sonda oční dutá; 0,6 mm; 10,0 cm	Eye probe; 0,6 mm; 10,0 cm	412
133 38 0220	Sonda oční dutá; 0,7 mm; 10,0 cm	Eye probe; 0,7 mm; 10,0 cm	412
133 38 0230	Sonda oční dutá; 0,8 mm; 10,0 cm	Eye probe; 0,8 mm; 10,0 cm	412
133 38 0240	Sonda oční dutá; 0,9 mm; 10,0 cm	Eye probe; 0,9 mm; 10,0 cm	412
133 91 0059	Nabatoff soubor sond na křečové žíly	Nabatoff varicose vein probe set complete	406
133 91 0060	Sonda kovová; 3,0 mm	Probe tip only metal; 3,0 mm	406
133 91 0061	Olivka; 6,0 mm	Olive; 6,0 mm	406
133 91 0062	Olivka; 9,0 mm	Olive; 9,0 mm	406
133 91 0063	Olivka; 12,0 mm	Olive; 12,0 mm	406
133 91 0064	Držátko	Handle only	406
133 91 0065	Zavaděč nerezový	Cable flexible stainless	406
133 91 0066	Sonda plastová	Probe tip plastic material	406
133 91 0067	Garrett sonda cévní ohebná; 1,0 mm; 14,0 cm	Garrett vascular dilatator malleable; 1,0 mm; 14,0 cm	408
133 91 0068	Garrett sonda cévní ohebná; 1,5 mm; 14,0 cm	Garrett vascular dilatator malleable; 1,5 mm; 14,0 cm	408
133 91 0069	Garrett sonda cévní ohebná; 2,0 mm; 14,0 cm	Garrett vascular dilatator malleable; 2,0 mm; 14,0 cm	408
133 91 0070	Garrett sonda cévní ohebná; 2,5 mm; 14,0 cm	Garrett vascular dilatator malleable; 2,5 mm; 14,0 cm	408
133 91 0071	Garrett sonda cévní ohebná; 3,0 mm; 14,0 cm	Garrett vascular dilatator malleable; 3,0 mm; 14,0 cm	408
133 91 0072	Garrett sonda cévní ohebná; 3,5 mm; 14,0 cm	Garrett vascular dilatator malleable; 3,5 mm; 14,0 cm	408
133 91 0073	Garrett sonda cévní ohebná; 4,0 mm; 14,0 cm	Garrett vascular dilatator malleable; 4,0 mm; 14,0 cm	408
133 91 0074	Garrett sonda cévní ohebná; 4,5 mm; 14,0 cm	Garrett vascular dilatator malleable; 4,5 mm; 14,0 cm	408
133 91 0075	Garrett sonda cévní ohebná; 5,0 mm; 14,0 cm	Garrett vascular dilatator malleable; 5,0 mm; 14,0 cm	408
133 91 0076	Garrett sonda tracheální ohebná; 1,0 mm; 21,0 cm	Garrett tracheal dilatator malleable; 1,0 mm; 21,0 cm	408
133 91 0077	Garrett sonda tracheální ohebná; 1,5 mm; 21,0 cm	Garrett tracheal dilatator malleable; 1,5 mm; 21,0 cm	408
133 91 0078	Garrett sonda tracheální ohebná; 2,0 mm; 21,0 cm	Garrett tracheal dilatator malleable; 2,0 mm; 21,0 cm	408
133 91 0079	Garrett sonda cévní ohebná; 2,5 mm; 21,0 cm	Garrett vascular dilatator malleable; 2,5 mm; 21,0 cm	408
133 91 0080	Garrett sonda cévní ohebná; 3,0 mm; 21,0 cm	Garrett vascular dilatator malleable; 3,0 mm; 21,0 cm	408

číslo – number	název	item	strana – page
133 91 0081	Garrett sonda cévní ohebná; 3,5 mm; 21,0 cm	Garrett vascular dilatator malleable; 3,5 mm; 21,0 cm	408
133 91 0082	Garrett sonda cévní ohebná; 4,0 mm; 21,0 cm	Garrett vascular dilatator malleable; 4,0 mm; 21,0 cm	408
133 91 0083	Garrett sonda cévní ohebná; 4,5 mm; 21,0 cm	Garrett vascular dilatator malleable; 4,5 mm; 21,0 cm	408
133 91 0084	Garrett sonda cévní ohebná; 5,0 mm; 21,0 cm	Garrett vascular dilatator malleable; 5,0 mm; 21,0 cm	408
133 99 0020	Babcock pátradlo ohebné; 60,0 cm	Babcock probe flexible; 60,0 cm	408
133 99 0021	Babcock pátradlo ohebné; 40,0 cm	Babcock probe flexible; 40,0 cm	408
133 99 0023	Babcock pátradlo ohebné; 70,0 cm	Babcock probe flexible; 70,0 cm	408
133 99 0024	Babcock pátradlo ohebné; 80,0 cm	Babcock probe flexible; 80,0 cm	408
133 99 0095	Jehla na odběr kostní dřeviny; 2 mm; 11,8 cm	Bone marrow extraction needles; 2 mm; 11,8 cm	405
133 99 0096	Jehla na odběr kostní dřeviny; 3 mm; 14,5 cm	Bone marrow extraction needles; 3 mm; 14,5 cm	405
134	TROKARY, ODSÁVAČKY	TROCARS, SUCTION TUBES	
134 08 0080	Držadlo bez regulace	Handle without regulation	419
134 08 0090	Držadlo s regulací	Handle with regulation	419
134 08 0100	Odsávačka oblouková mikro; 1 mm; 13,0 cm	Suction tube; 1 mm; 13,0 cm	419
134 08 0110	Odsávačka oblouková mikro; 2 mm; 13,0 cm	Suction tube; 2 mm; 13,0 cm	419
134 08 0120	Odsávačka oblouková mikro; 3 mm; 13,0 cm	Suction tube; 3 mm; 13,0 cm	419
134 08 0130	Odsávačka oblouková mikro; 4 mm; 14,5 cm	Suction tube; 4 mm; 14,5 cm	419
134 08 0140	Odsávačka oblouková mikro; 5 mm; 14,5 cm	Suction tube; 5 mm; 14,5 cm	419
134 08 0150	Odsávačka oblouková mikro; 6 mm; 14,5 cm	Suction tube; 6 mm; 14,5 cm	419
134 08 0200	Odsávačka oblouková mikro; 1 mm; 15,0 cm	Suction tube; 1 mm; 15,0 cm	419
134 08 0210	Odsávačka oblouková mikro; 2 mm; 15,0 cm	Suction tube; 2 mm; 15,0 cm	419
134 08 0220	Odsávačka oblouková mikro; 3 mm; 15,0 cm	Suction tube; 3 mm; 15,0 cm	419
134 08 0230	Odsávačka oblouková mikro; 4 mm; 16,5 cm	Suction tube; 4 mm; 16,5 cm	419
134 08 0240	Odsávačka oblouková mikro; 5 mm; 16,5 cm	Suction tube; 5 mm; 16,5 cm	419
134 08 0250	Odsávačka oblouková mikro; 6 mm; 16,5 cm	Suction tube; 6 mm; 16,5 cm	419
134 08 0300	Odsávačka lomená mikro; 1 mm; 8,0 cm	Suction tube; 1 mm; 8,0 cm	419
134 08 0310	Odsávačka lomená mikro; 2 mm; 8,0 cm	Suction tube; 2 mm; 8,0 cm	419
134 08 0320	Odsávačka lomená mikro; 1 mm; 12,0 cm	Suction tube; 1 mm; 12,0 cm	419
134 08 0330	Odsávačka lomená mikro; 2 mm; 12,0 cm	Suction tube; 2 mm; 12,0 cm	419
134 08 0400	Odsávačka silně zahnutá mikro; 1 mm; 9,0 cm	Suction tube; 1 mm; 9,0 cm	419
134 08 0410	Odsávačka silně zahnutá mikro; 2 mm; 9,0 cm	Suction tube; 2 mm; 9,0 cm	419
134 08 0420	Odsávačka silně zahnutá mikro; 3 mm; 9,0 cm	Suction tube; 3 mm; 9,0 cm	419
134 08 0430	Odsávačka silně zahnutá mikro; 4 mm; 9,0 cm	Suction tube; 4 mm; 9,0 cm	419
134 08 0440	Odsávačka silně zahnutá mikro; 5 mm; 9,0 cm	Suction tube; 5 mm; 9,0 cm	419
134 08 0500	Odsávačka silně zahnutá mikro; 1 mm; 12,0 cm	Suction tube; 1 mm; 12,0 cm	419
134 08 0510	Odsávačka silně zahnutá mikro; 2 mm; 12,0 cm	Suction tube; 2 mm; 12,0 cm	419
134 08 0520	Odsávačka silně zahnutá mikro; 3 mm; 12,0 cm	Suction tube; 3 mm; 12,0 cm	419
134 08 0530	Odsávačka silně zahnutá mikro; 4 mm; 12,0 cm	Suction tube; 4 mm; 12,0 cm	419
134 08 0540	Odsávačka silně zahnutá mikro; 5 mm; 12,0 cm	Suction tube; 5 mm; 12,0 cm	419
134 08 0600	Odsávačka silně zahnutá mikro; 1 mm; 16,0 cm	Suction tube; 1 mm; 16,0 cm	419
134 08 0610	Odsávačka silně zahnutá mikro; 2 mm; 16,0 cm	Suction tube; 2 mm; 16,0 cm	419
134 08 0620	Odsávačka silně zahnutá mikro; 3 mm; 16,0 cm	Suction tube; 3 mm; 16,0 cm	419
134 08 0630	Odsávačka silně zahnutá mikro; 4 mm; 16,0 cm	Suction tube; 4 mm; 16,0 cm	419
134 08 0640	Odsávačka silně zahnutá mikro; 5 mm; 16,0 cm	Suction tube; 5 mm; 16,0 cm	419
134 29 0010	Jehla punkční; 1,5 mm; 11,4 cm	Puncture needle; 1,5 mm; 11,4 cm	415
134 29 0020	Jehla punkční; 2,0 mm; 11,4 cm	Puncture needle; 2,0 mm; 11,4 cm	415
134 29 0030	Jehla punkční; 2,5 mm; 11,4 cm	Puncture needle; 2,5 mm; 11,4 cm	415
134 29 0040	Jehla punkční; 3,0 mm; 11,4 cm	Puncture needle; 3,0 mm; 11,4 cm	415
134 29 0050	Jehla punkční; 3,5 mm; 11,4 cm	Puncture needle; 3,5 mm; 11,4 cm	415
134 91 0007	Standard trokar s ochranným pouzdrem; 3,0 mm	Standard trocar; 3,0 mm	417
134 91 0008	Standard trokar s ochranným pouzdrem; 4,0 mm	Standard trocar; 4,0 mm	417
134 91 0009	Standard trokar s ochranným pouzdrem; 5,0 mm	Standard trocar; 5,0 mm	417
134 91 0010	Standard trokar s ochranným pouzdrem; 6,0 mm	Standard trocar; 6,0 mm	417
134 91 0011	Standard trokar ostrý s uzávěrem; 3,0 mm	Standard trocar; 3,0 mm	417
134 91 0012	Standard trokar ostrý s uzávěrem; 4,0 mm	Standard trocar; 4,0 mm	417
134 91 0013	Standard trokar ostrý s uzávěrem; 5,5 mm	Standard trocar; 5,5 mm	417
134 91 0014	Standard trokar ostrý s uzávěrem; 6,0 mm	Standard trocar; 6,0 mm	417
134 91 0015	Standard trokar ostrý s uzávěrem a trubičkou; 3,0 mm	Standard trocar; 3,0 mm	417
134 91 0016	Standard trokar ostrý s uzávěrem a trubičkou; 4,0 mm	Standard trocar; 4,0 mm	417
134 91 0017	Standard trokar ostrý s uzávěrem a trubičkou; 5,0 mm	Standard trocar; 5,0 mm	417
134 91 0018	Standard trokar ostrý s uzávěrem a trubičkou; 6,0 mm	Standard trocar; 6,0 mm	417
134 91 0019	Nelson trokar fig.1; 7,5 mm; 21,0 cm	Nelson trocar fig.1; 7,5 mm; 21,0 cm	418
134 91 0020	Nelson trokar fig.2; 9,5 mm; 21,0 cm	Nelson trocar fig.2; 9,5 mm; 21,0 cm	418
134 91 0021	Nelson trokar fig.3; 11,0 mm; 21,0 cm	Nelson trocar fig.3; 11,0 mm; 21,0 cm	418
134 91 0022	Nelson trokar fig.4; 12,5 mm; 21,0 cm	Nelson trocar fig.4; 12,5 mm; 21,0 cm	418
134 91 0023	Buelau trokar; 8,0 mm; 24,0 cm	Buelau trocar; 8,0 mm; 24,0 cm	418
134 91 0050	Yankauer odsávačka; 10,0 mm; 27,0 cm	Yankauer suction tube; 10,0 mm; 27,0 cm	422
134 91 0053	De Bakey odsávačka; 9,0 mm; 27,5 cm	De Bakey suction tube; 9,0 mm; 27,5 cm	422
134 91 0058	Poole odsávačka rovná; 10,0 mm; 22,0 cm	Poole suction tube; 10,0 mm; 22,0 cm	422
134 91 0059	Poole odsávačka zahnutá; 8,0 mm; 22,0 cm	Poole suction tube; 8,0 mm; 22,0 cm	422
134 91 0060	Baby-Poole odsávačka; 5,5 mm; 20,0 cm	Baby-Poole suction tube; 5,5 mm; 20,0 cm	422

číslo – number	název	item	strana – page
134 91 0141	Jehla zaváděcí; 8 Ch	Guide needle; 8 Ch	415
134 91 0142	Jehla zaváděcí; 10 Ch	Guide needle; 10 Ch	415
134 91 0143	Jehla zaváděcí; 12 Ch	Guide needle; 12 Ch	415
134 91 0144	Jehla zaváděcí; 14 Ch	Guide needle; 14 Ch	415
134 91 0145	Jehla zaváděcí; 16 Ch	Guide needle; 16 Ch	415
134 91 0146	Jehla zaváděcí; 18 Ch	Guide needle; 18 Ch	415
134 91 0147	Jehla zaváděcí; 8 Ch	Guide needle; 8 Ch	415
134 91 0148	Jehla zaváděcí; 10 Ch	Guide needle; 10 Ch	415
134 91 0149	Jehla zaváděcí; 12 Ch	Guide needle; 12 Ch	415
134 91 0150	Jehla zaváděcí; 14 Ch	Guide needle; 14 Ch	415
134 91 0151	Jehla zaváděcí; 16 Ch	Guide needle; 16 Ch	415
134 91 0152	Jehla zaváděcí; 18 Ch	Guide needle; 18 Ch	415
134 99 0029	Odsávačka zahnutá s olivkou Luer; 2,5 mm; 12,5 cm	Suction tube with regulation and olive; 2,5 mm; 12,5 cm	420
134 99 0126	Odsávačka s regulací a olivkou; 1,5 mm; 10,0 cm	Suction tube with regulation and olive; 1,5 mm; 10,0 cm	421
134 99 0128	Odsávačka s regulací a olivkou; 2,0 mm; 5,0 cm	Suction tube with regulation and olive; 2,0 mm; 5,0 cm	421
134 99 0129	Odsávačka s regulací a olivkou; 2,0 mm; 8,0 cm	Suction tube with regulation and olive; 2,0 mm; 8,0 cm	421
134 99 0130	Odsávačka s regulací a olivkou; 2,0 mm; 10,0 cm	Suction tube with regulation and olive; 2,0 mm; 10,0 cm	421
134 99 0131	Odsávačka s regulací a olivkou; 2,0 mm; 12,0 cm	Suction tube with regulation and olive; 2,0 mm; 12,0 cm	421
134 99 0132	Odsávačka s regulací a olivkou; 3,0 mm; 5,0 cm	Suction tube with regulation and olive; 3,0 mm; 5,0 cm	421
134 99 0133	Odsávačka s regulací a olivkou; 3,0 mm; 8,0 cm	Suction tube with regulation and olive; 3,0 mm; 8,0 cm	421
134 99 0134	Odsávačka s regulací a olivkou; 3,0 mm; 10,0 cm	Suction tube with regulation and olive; 3,0 mm; 10,0 cm	421
134 99 0156	Kanyla s olivkou lomená - Luer; 1,2 mm; 8,5 cm	Suction tube with olive - Luer; 1,2 mm; 8,5 cm	420
134 99 0157	Kanyla s olivkou lomená - Luer; 1,5 mm; 8,5 cm	Suction tube with olive - Luer; 1,5 mm; 8,5 cm	420
134 99 0164	Odsávačka lomená - Luer; 2 mm; 8,5cm	Suction tube - Luer; 2 mm; 8,5cm	420
134 99 0175	Přechodka - Luer	Connecting piece - Luer	420
134 99 0186	Kanyla osazená lomená - Luer; 0,6 mm; 8,6 cm	Suction tube - Luer; 0,6 mm; 8,6 cm	420
134 99 0246	Kanyla s olivkou rovná - Luer; 1,2 mm; 8,0 cm	Suction tube - Luer; 1,2 mm; 8,0 cm	420
134 99 0247	Kanyla s olivkou rovná - Luer; 1,5 mm; 8,0 cm	Suction tube - Luer; 1,5 mm; 8,0 cm	420
134 99 0267	Odsávačka s regulací a olivkou; 1,5 mm; 8,0 cm	Suction tube with regulation and olive; 1,5 mm; 8,0 cm	421
134 99 0268	Odsávačka s regulací a olivkou; 1,0 mm; 10,0 cm	Suction tube with regulation and olive; 1,0 mm; 10,0 cm	421
134 99 0307	Odsávačka s regulací a olivkou; 2,0 mm; 10,0 cm	Suction tube with regulation and olive; 2,0 mm; 10,0 cm	421
134 99 0308	Odsávačka s regulací a olivkou; 2,0 mm; 8,0 cm	Suction tube with regulation and olive; 2,0 mm; 8,0 cm	421
134 99 0309	Odsávačka s regulací a olivkou; 1,5 mm; 8,0 cm	Suction tube with regulation and olive; 1,5 mm; 8,0 cm	421
134 99 0310	Odsávačka s regulací a olivkou; 1,5 mm; 5,0 cm	Suction tube with regulation and olive; 1,5 mm; 5,0 cm	421
134 99 0314	Kanyla s olivkou rovná - Luer; 1,5 mm; 10,0 cm	Suction tube - Luer; 1,5 mm; 10,0 cm	420
134 99 0315	Kanyla s olivkou rovná - Luer; 1,2 mm; 10,0 cm	Suction tube - Luer; 1,2 mm; 10,0 cm	420
134 99 0562	Kanyla laryngeální; 2,5 mm; 13,0 cm	Laryngeal cannula; 2,5 mm; 13,0 cm	420
134 99 0563	Kanyla laryngeální; 2,5 mm; 15,0 cm	Laryngeal cannula; 2,5 mm; 15,0 cm	420
135	DILATÁTORY	DILATORS	
135 22 0010	Dilatátor urologický krátký rovný; 8 Ch; 17,0 cm	Urological dilator short straight; 8 Ch; 17,0 cm	425
135 22 0020	Dilatátor urologický krátký rovný; 9 Ch; 17,0 cm	Urological dilator short straight; 9 Ch; 17,0 cm	425
135 22 0030	Dilatátor urologický krátký rovný; 10 Ch; 17,0 cm	Urological dilator short straight; 10 Ch; 17,0 cm	425
135 22 0040	Dilatátor urologický krátký rovný; 11 Ch; 17,0 cm	Urological dilator short straight; 11 Ch; 17,0 cm	425
135 22 0050	Dilatátor urologický krátký rovný; 12 Ch; 17,0 cm	Urological dilator short straight; 12 Ch; 17,0 cm	425
135 22 0060	Dilatátor urologický krátký rovný; 13 Ch; 17,0 cm	Urological dilator short straight; 13 Ch; 17,0 cm	425
135 22 0070	Dilatátor urologický krátký rovný; 14 Ch; 17,0 cm	Urological dilator short straight; 14 Ch; 17,0 cm	425
135 22 0080	Dilatátor urologický krátký rovný; 15 Ch; 17,0 cm	Urological dilator short straight; 15 Ch; 17,0 cm	425
135 22 0090	Dilatátor urologický krátký rovný; 16 Ch; 17,0 cm	Urological dilator short straight; 16 Ch; 17,0 cm	425
135 22 0100	Dilatátor urologický krátký rovný; 17 Ch; 17,0 cm	Urological dilator short straight; 17 Ch; 17,0 cm	425
135 22 0110	Dilatátor urologický krátký rovný; 18 Ch; 17,0 cm	Urological dilator short straight; 18 Ch; 17,0 cm	425
135 22 0120	Dilatátor urologický krátký rovný; 19 Ch; 17,0 cm	Urological dilator short straight; 19 Ch; 17,0 cm	425
135 22 0130	Dilatátor urologický krátký rovný; 20 Ch; 17,0 cm	Urological dilator short straight; 20 Ch; 17,0 cm	425
135 22 0140	Dilatátor urologický krátký rovný; 21 Ch; 17,0 cm	Urological dilator short straight; 21 Ch; 17,0 cm	425
135 22 0150	Dilatátor urologický krátký rovný; 22 Ch; 17,0 cm	Urological dilator short straight; 22 Ch; 17,0 cm	425
135 22 0160	Dilatátor urologický krátký rovný; 23 Ch; 17,0 cm	Urological dilator short straight; 23 Ch; 17,0 cm	425
135 22 0170	Dilatátor urologický krátký rovný; 24 Ch; 17,0 cm	Urological dilator short straight; 24 Ch; 17,0 cm	425
135 22 0180	Dilatátor urologický krátký rovný; 25 Ch; 17,0 cm	Urological dilator short straight; 25 Ch; 17,0 cm	425
135 22 0190	Dilatátor urologický krátký rovný; 26 Ch; 17,0 cm	Urological dilator short straight; 26 Ch; 17,0 cm	425
135 22 0200	Dilatátor urologický krátký rovný; 27 Ch; 17,0 cm	Urological dilator short straight; 27 Ch; 17,0 cm	425
135 22 0210	Dilatátor urologický krátký rovný; 28 Ch; 17,0 cm	Urological dilator short straight; 28 Ch; 17,0 cm	425
135 22 0330	Dilatátor urologický dlouhý zahnutý; 8 Ch; 27,0 cm	Urological dilator long curved; 8 Ch; 27,0 cm	425
135 22 0340	Dilatátor urologický dlouhý zahnutý; 9 Ch; 27,0 cm	Urological dilator long curved; 9 Ch; 27,0 cm	425
135 22 0350	Dilatátor urologický dlouhý zahnutý; 10 Ch; 27,0 cm	Urological dilator long curved; 10 Ch; 27,0 cm	425
135 22 0360	Dilatátor urologický dlouhý zahnutý; 11 Ch; 27,0 cm	Urological dilator long curved; 11 Ch; 27,0 cm	425
135 22 0370	Dilatátor urologický dlouhý zahnutý; 12 Ch; 27,0 cm	Urological dilator long curved; 12 Ch; 27,0 cm	425
135 22 0380	Dilatátor urologický dlouhý zahnutý; 13 Ch; 27,0 cm	Urological dilator long curved; 13 Ch; 27,0 cm	425
135 22 0390	Dilatátor urologický dlouhý zahnutý; 14 Ch; 27,0 cm	Urological dilator long curved; 14 Ch; 27,0 cm	425
135 22 0400	Dilatátor urologický dlouhý zahnutý; 15 Ch; 27,0 cm	Urological dilator long curved; 15 Ch; 27,0 cm	425
135 22 0410	Dilatátor urologický dlouhý zahnutý; 16 Ch; 27,0 cm	Urological dilator long curved; 16 Ch; 27,0 cm	425
135 22 0420	Dilatátor urologický dlouhý zahnutý; 17 Ch; 27,0 cm	Urological dilator long curved; 17 Ch; 27,0 cm	425
135 22 0430	Dilatátor urologický dlouhý zahnutý; 18 Ch; 27,0 cm	Urological dilator long curved; 18 Ch; 27,0 cm	425

číslo – number	název	item	strana – page
135 91 0045	Hegar dilatátor hrdla děložního tupý; 26,0 mm; 21,0 cm	Hegar uterine dilator; 26,0 mm; 21,0 cm	426
135 91 0046	Hegar dilatátor hrdla děložního tupý; 27,0 mm; 21,0 cm	Hegar uterine dilator; 27,0 mm; 21,0 cm	426
135 91 0047	Hegar dilatátor hrdla děložního tupý; 28,0 mm; 21,0 cm	Hegar uterine dilator; 28,0 mm; 21,0 cm	426
135 91 0048	Hegar dilatátor hrdla děložního tupý; 29,0 mm; 21,0 cm	Hegar uterine dilator; 29,0 mm; 21,0 cm	426
135 91 0049	Hegar dilatátor hrdla děložního tupý; 30,0 mm; 21,0 cm	Hegar uterine dilator; 30,0 mm; 21,0 cm	426
135 99 0001	Dilatátor urologický dlouhý rovný; 20 Ch; 20,0 cm	Urological dilator long straight; 20 Ch; 20,0 cm	425
135 99 0002	Dilatátor urologický dlouhý rovný; 22 Ch; 20,0 cm	Urological dilator long straight; 22 Ch; 20,0 cm	425
135 99 0003	Dilatátor urologický dlouhý rovný; 23 Ch; 20,0 cm	Urological dilator long straight; 23 Ch; 20,0 cm	425
135 99 0004	Dilatátor urologický dlouhý rovný; 24 Ch; 20,0 cm	Urological dilator long straight; 24 Ch; 20,0 cm	425
135 99 0005	Dilatátor urologický dlouhý rovný; 25 Ch; 20,0 cm	Urological dilator long straight; 25 Ch; 20,0 cm	425
135 99 0006	Dilatátor urologický dlouhý rovný; 26 Ch; 20,0 cm	Urological dilator long straight; 26 Ch; 20,0 cm	425
135 99 0007	Dilatátor urologický dlouhý rovný; 27 Ch; 20,0 cm	Urological dilator long straight; 27 Ch; 20,0 cm	425
135 99 0008	Dilatátor urologický dlouhý rovný; 28 Ch; 20,0 cm	Urological dilator long straight; 28 Ch; 20,0 cm	425
136	SPECIÁLNÍ NÁSTROJE	SPECIAL INSTRUMENTS	
136 08 0510	Elektroda rovná jehlová; 2,4 mm; 0,25×15,0 mm; 5,5 cm	Electrode; 2,4 mm; 0,25×15,0 mm; 5,5 cm	429
136 08 0520	Elektroda rovná jehlová; 2,4 mm; 0,4×15,0 mm; 5,5 cm	Electrode; 2,4 mm; 0,4×15,0 mm; 5,5 cm	429
136 08 0530	Elektroda rovná jehlová; 2,4 mm; 0,6×15,0 mm; 5,5 cm	Electrode; 2,4 mm; 0,6×15,0 mm; 5,5 cm	429
136 08 0540	Elektroda ohnutá s jehlou; 2,4 mm; 0,6×10,0 mm; 5,0 cm	Electrode; 2,4 mm; 0,6×10,0 mm; 5,0 cm	429
136 08 0550	Elektroda ohnutá rovnoběžná; 2,4 mm; 2,0×5,0 mm; 4,7 cm	Electrode; 2,4 mm; 2,0×5,0 mm; 4,7 cm	429
136 08 0560	Elektroda kruhová; 2,4 mm; 5,0 mm; 4,7 cm	Electrode; 2,4 mm; 5,0 mm; 4,7 cm	429
136 08 0570	Elektroda smyč. lichoběžníková; 2,4 mm; 5,0×7,0 mm; 4,7 cm	Electrode; 2,4 mm; 5,0×7,0 mm; 4,7 cm	429
136 08 0580	Elektroda kulíčková rovná; 2,4 mm; 2,4 mm; 4,2 cm	Electrode; 2,4 mm; 2,4 mm; 4,2 cm	429
136 08 0590	Elektroda kulíčková rovná; 2,4 mm; 4,0 mm; 4,4 cm	Electrode; 2,4 mm; 4,0 mm; 4,4 cm	429
136 17 0110	Soubor nástrojů na protěti příčného vazů zápěstí	Instruments for cutting of wrist ligaments	430
136 17 0120	Pouzdro vodič; 5,0 mm; 9,3 cm	Guide sleeve; 5,0 mm; 9,3 cm	430
136 17 0130	Zavaděč pouzdra vodič; 19,9 cm	Guide for sleeve; 19,9 cm	430
136 17 0140	Háček; 4,3×2,5 mm; 21,0 cm	Hook; 4,3×2,5 mm; 21,0 cm	430
136 17 0150	Nůž trojúhelníkový; 4,3×1,5 mm; 21,0 cm	Knife; 4,3×1,5 mm; 21,0 cm	430
136 17 0160	Nůž háčkový; 4,3×1,5 mm; 21,0 cm	Knife; 4,3×1,5 mm; 21,0 cm	430
136 19 0010	Aplikátor mechanický na hemoroidy; 24,6 cm	Hemorrhoidal applicator; 24,6 cm	431
136 19 0020	Aplikátor sací na hemoroidy; 21,0 cm	Hemorrhoidal applicator; 21,0 cm	431
136 27 0310	Extraktor kovový; 26,5 cm	Extractor; 26,5 cm	432
136 27 0311	Extraktor kovový; 26,5 cm	Extractor; 26,5 cm	432
136 39 0050	Touleč na pinzety s podstavcem; 11,0 cm	Tweezer quiver with stand; 11,0 cm	433
136 39 0060	Touleč na kleště s podstavcem; 20,0 cm	Forceps quiver with stand; 20,0 cm	433
136 39 0070	Touleč na pinzety s podstavcem; 9,0 cm	Tweezer quiver with stand; 9,0 cm	433
136 91 0036	Krabice na nástroje s víkem; 16,5×9,0×3,5 cm	Box for instruments with a lid; 16,5×9,0×3,5 cm	434
136 91 0037	Krabice na nástroje s víkem; 20,0×10,0×5,0 cm	Box for instruments with a lid; 20,0×10,0×5,0 cm	434
136 91 0038	Krabice na nástroje s víkem; 22,0×15,0×5,0 cm	Box for instruments with a lid; 22,0×15,0×5,0 cm	434
136 91 0039	Krabice na nástroje s víkem; 26,0×15,0×5,0 cm	Box for instruments with a lid; 26,0×15,0×5,0 cm	434
136 91 0040	Krabice na nástroje s víkem; 30,5×20,5×5,0 cm	Box for instruments with a lid; 30,5×20,5×5,0 cm	434
136 91 0070	Touleč nerez ocel; 50×100 mm	Quiver stainless steel; 50×100 mm	433
136 91 0071	Touleč nerez ocel; 75×175 mm	Quiver stainless steel; 75×175 mm	433
136 91 0072	Touleč nerez ocel; 30×90 mm	Quiver stainless steel; 30×90 mm	433
136 91 0073	Touleč nerez ocel; 50×130 mm	Quiver stainless steel; 50×130 mm	433
136 91 0074	Touleč nerez ocel; 50×175 mm	Quiver stainless steel; 50×175 mm	433
136 91 0075	Touleč nerez ocel; 75×100 mm	Quiver stainless steel; 75×100 mm	433
136 91 0076	Touleč nerez ocel; 75×130 mm	Quiver stainless steel; 75×130 mm	433
136 91 0077	Miska; 0,05 l; 4,0×1,9 cm	Bowl; 0,05 l; 4,0×1,9 cm	434
136 91 0078	Miska; 0,07 l; 6,1×3,0 cm	Bowl; 0,07 l; 6,1×3,0 cm	434
136 91 0079	Miska; 0,14 l; 8,0×4,0 cm	Bowl; 0,14 l; 8,0×4,0 cm	434
136 91 0080	Miska; 0,35 l; 11,6×5,0 cm	Bowl; 0,35 l; 11,6×5,0 cm	434
136 91 0081	Miska; 0,45 l; 12,8×5,5 cm	Bowl; 0,45 l; 12,8×5,5 cm	434
136 91 0082	Miska; 0,70 l; 14,7×6,5 cm	Bowl; 0,70 l; 14,7×6,5 cm	434
136 91 0083	Nálevka; 0,25 l	Funnel; 0,25 l	434
136 91 0084	Nálevka; 0,5 l	Funnel; 0,5 l	434
136 91 0085	Nálevka; 1,0 l	Funnel; 1,0 l	434
136 91 0086	Nálevka; 2,0 l	Funnel; 2,0 l	434
136 91 0087	Miska; 17,0 cm	Bowl; 17,0 cm	434
136 91 0088	Miska; 25,0 cm	Bowl; 25,0 cm	434
136 91 0089	Miska; 27,5 cm	Bowl; 27,5 cm	434
136 91 0090	Jehelník; 6,5 cm	Needle case; 6,5 cm	436
136 91 0091	Vnitřní krabička pouze pro jehelník	Inter box for needle case	436
136 91 0092	Jehelník; 5,0×2,5×0,45 cm	Needle case; 5,0×2,5×0,45 cm	436
136 91 0093	Jehelník; 6,5×4,2×8,0 cm	Needle case; 6,5×4,2×8,0 cm	436
136 91 0094	Jehelník; 7,5×2,5×0,45 cm	Needle case; 7,5×2,5×0,45 cm	436
136 91 0095	Sauerbruch jehelník; 21,0×12,5×1,7 cm	Sauerbruch needle case; 21,0×12,5×1,7 cm	436
136 91 0096	Jehelník; 15,0×9,5×1,3 cm	Needle case; 15,0×9,5×1,3 cm	436
136 91 0097	Tác; 23,0×15,5×3,0 cm	Tray; 23,0×15,5×3,0 cm	435
136 91 0098	Tác; 30,0×17,5×3,0 cm	Tray; 30,0×17,5×3,0 cm	435
136 91 0099	Tác; 30,0×17,5×4,0 cm	Tray; 30,0×17,5×4,0 cm	435

číslo – number	název	item	strana – page
136 91 0100	Táč; 35,0×24,0×3,6 cm	Tray; 35,0×24,0×3,6 cm	435
136 91 0101	Táč; 40,0×30,0×5,0 cm	Tray; 40,0×30,0×5,0 cm	435
136 91 0102	Táč; 21,0×16,0×1,0 cm	Tray; 21,0×16,0×1,0 cm	435
136 91 0103	Táč; 24,0×18,0×1,0 cm	Tray; 24,0×18,0×1,0 cm	435
136 91 0104	Táč; 31,0×15,0×1,0 cm	Tray; 31,0×15,0×1,0 cm	435
136 91 0105	Táč; 31,0×21,0×1,0 cm	Tray; 31,0×21,0×1,0 cm	435
136 91 0106	Táč; 35,0×24,0×1,0 cm	Tray; 35,0×24,0×1,0 cm	435
136 91 0107	Táč; 40,0×27,0×2,0 cm	Tray; 40,0×27,0×2,0 cm	435
136 91 0108	Táč; 42,0×28,0×1,0 cm	Tray; 42,0×28,0×1,0 cm	435
136 91 0109	Miska; 0,75 l; 16,5×6,0 cm	Bowl; 0,75 l; 16,5×6,0 cm	435
136 91 0110	Miska; 1,0 l; 17,5×7,0 cm	Bowl; 1,0 l; 17,5×7,0 cm	435
136 91 0111	Miska; 2,0 l; 22,0×8,0 cm	Bowl; 2,0 l; 22,0×8,0 cm	435
136 91 0113	Miska; 2,75 l; 24,0×11,0 cm	Bowl; 2,75 l; 24,0×11,0 cm	435
136 91 0114	Miska; 4,0 l; 27,5×11,5 cm	Bowl; 4,0 l; 27,5×11,5 cm	435
136 91 0115	Miska; 5,5 l; 29,0×12,5 cm	Bowl; 5,5 l; 29,0×12,5 cm	435
136 91 0116	Miska; 8,0 l; 31,0×12,0 cm	Bowl; 8,0 l; 31,0×12,0 cm	435
136 91 0117	Miska; 12,0 l; 34,5×12,5 cm	Bowl; 12,0 l; 34,5×12,5 cm	435
136 91 0118	Miska; 14,0 l; 38,0×13,0 cm	Bowl; 14,0 l; 38,0×13,0 cm	435
136 91 0128	Mayo spona na nástroje	Mayo safety pins	437
136 91 0129	Mayo spona na nástroje	Mayo safety pins	437
139	SOUBORY	SETS	
139 01 0090	Soubor pro mediky	Set for medics	441
139 08 0050	Rozvěrač se stavitelným háky	Hook retractor	296
139 14 0010	Soubor pro operaci varixů	Varices operation set	33
139 39 0010	Síto sterilizační fig.1	Sterilization sleeve fig.1	442
139 39 0020	Síto sterilizační fig.2	Sterilization sleeve fig.2	442
139 39 0030	Síto sterilizační fig.3	Sterilization sleeve fig.3	442
139 39 0040	Síto sterilizační fig.4	Sterilization sleeve fig.4	442
139 50 0300	Krabice	Box	451
285	VYROBKY Z PLASTŮ	PLASTIC PRODUCTS	
285 553 54 6521	Rouška pro dýchání z plic do plic	Mask for breathing	447
285 753 54 7010	Souprava pro odběr sputa; 26×62 mm; jednorázová	Test tube for sputum; 26×62 mm; single-use	445
285 753 54 7011	Souprava pro odběr stolice; 26×62 mm; jednorázová	Set for stool taking; 26×62 mm; single-use	445
285 753 54 7012	Souprava pro odběr krve a moče; 16×100 mm; jednorázová	Set of blood and urine taking; 16×10 mm; single-use	445
285 770 10 0102	Zkumavka pro analyzátor s rovným okrajem; 17×38 mm	Test tube for analyzer with flat border; 17×38 mm	446
285 770 10 0110	Nádobka pro přípravu vzorků; 42×35 mm	Small container for sample preparation; 42×35 mm	446
285 772 54 9235	Zkumavka jednorázová; 12,5×75 mm	Test tube, 12,5×75 mm; single-use	446
285 775 54 9233	Zkumavka pro standardizaci; 18×95 mm	Test tube for standardization; 18×95 mm	446
285 776 54 9374	Zkumavka na mléko s víčkem; 30×65 mm	Test tube for milk with lid; 30×65 mm	445
285 776 54 9375	Zkumavka na mléko s víčkem plochým; 30×65 mm	Test tube for milk with flat lid; 30×65 mm	445
285 799 54 4900	Klička odměrná z ph 1 mikrolitr; 19,5 cm	Measuring loop 1 µl; 19,5 cm	446
285 799 54 4901	Klička odměrná z ph 10 mikrolitrů; 19,5 cm	Measuring loop 10 µl; 19,5 cm	446
285 943 94 0066	Víčko ke zkumavce na mléko ploché	Lid for test tube for milk flat	445
285 943 94 0123	Víčko ke zkumavce na mléko	Lid for test tube for milk	445
397 238 10 2000	Pohár na moč 250 ml	Glass for urine 250 ml	446
397 238 10 5000	Pohár na moč 100 ml	Glass for urine 100 ml	446
571	OSTATNÍ	OTHERS	
571 00 8800	Soubor veterinární šicí	Suturing veterinary set	451

A

Adlerkreutz pinzeta chirurgická	95
Adson pinzeta anatomická	92, 110
Adson pinzeta chirurgická	92, 110
Adson rozvěrač ran	282, 286
Adson svorka na cévy	130
Adson-Brown pinzeta chirurgická	92
Agnew jehla paracentésní	37
Akumulátor do držadla	14
Allis kleště na střeva	235
Allis svorka chirurgická	114
Allison lopatka na plíce	305
Alm rozvěrač ostrý	279
Anderson-Adson rozvěrač	282
Aplikátor na hemoroidy	431
Aplikátor tamponády	33, 34
Arruga pinzeta na čočkové pouzdro	102
Ayer škrabka děložní	342

B

Babcock pátradlo ohebné	408
Babcock svorka chirurgická	114
Babinsky kladívko	21
Baby Metzenbaum nůžky micro super cut	77
Baby-Adson svorka na cévy	130
Baby-Crile-Wood jehelec	386
Baby-Mikulicz svorka na pobřišnici	146
Baby-Mixter svorka preparační	135
Baby-Poole odsávačka	422
Baby-Satinsky svorka cévní	187
Backhaus svorka na papír	188
Backhaus svorka na prádlo	189
Backhaus svorka s kuličkou	188
Backhaus-Clip svorka na prádlo	189
Baginsky nůž hrtanový	38
Bainbridge svorka atraumatická	158
Bainbridge svorka na cévy	131
Bakeš pátradlo na žlučovod	407
Bakeš sada pátradel na žlučovod	407
Balfour rozvěrač břišní	294
Ballanger nůž na nosní přepážku	39
Barraquer jehelec mikro	393
Barraquer nůžky na duhovku	67
Bartl kleště na vytažení kostních prutů	227
Beck svorka atraumatická	173, 179
Beckmann kyreta nosohltanová	39
Beckmann rozvěrač	283
Beckmann-Eaton rozvěrač	283
Beer pinzeta na řasy	105
Beeson kleště na sádrové obvazy	225
Bengolea svorka na cévy	132
Bensaude anoskop s obturátorem	321
Berliner reflexní kladívko	22
Bernhard svorka na prádlo	188
Berry jehelec	391
Berthold háček ušní	272
Bethune kleště na žebra	204
Beyer kleště štípací na kosti	198
Blascovics pinzeta na operaci šilhání	104
Blount hák na meniskus	273
Blount páka kostní	332
Blumenthal kleště štípací na kosti	195
Böhler kleště štípací na kosti	198
Bonefone pinzeta na čočkové pouzdro	103
Bonney pinzeta chirurgická	96, 110

Bowmann pátradlo oční	411
Boynton jehelec oční	379, 390
Bozemann jehelec hloubkový	387
Bozemann kleště tamponové	239
Braun-Stadler nůžky pro episiotomii	52
Bridge svorka preparační	136
Brown pinzeta chirurgická	94
Bruenings skřípec na mandle	358
Brunner hák na rány	259
Brunner jehla podvazovací	399
Brunner kleště na žebra	205
Brünnings lopatka na jazyk	307
Bruns nůžky na sádrové obvazy	72
Buck kladívko	21
Buelau trokar	418
Buchwald lopatka na jazyk	307
Bunge lžička exenterační	348

C

Caldwell-Luc hák na rány	261
Castroviejo jehelec	391, 392, 394
Castroviejo jehelec mikro	392, 394
Castroviejo nůžky na duhovku	67
Castroviejo nůžky oční	67, 68
Castroviejo pinzeta na rohovku	104
Catlin amputační nůž	41
Clar čelní lampa	20
Cleveland kleště štípací	203
Cleveland kleště štípací na kosti	195
Cleveland-Gardner kleště štípací	202
Cloward lžička	350
Collin amputační nůž	41
Collin dynamometr	23
Collin kleště na jazyk	246
Collin kleště na nádory	235
Collin kleště na výrustky	235
Collin kleště tamponové	239
Collin nůž amputační	41
Collin rozvěrač břišní	300
Collin rozvěrač ran	293
Collin svorka šicí	401
Collin-Baby rozvěrač břišní	300
Collin-Duval pinzeta úchočná	95
Cone rozvěrač	283
Cooley svorka atraumatická	175–178, 181
Cooley-Derra svorka atraumatická	179
Coryllos kleště na žebra	204
Cottle Kazanjian kleště štípací	202
Cottle nůžky nosní	64
Cottle páčidlo nosní	334, 335
Crafoord nůžky pro lobektomii	63
Crafoord svorka na cévy	133
Crafoord-Sellors svorka bronchiální	132
Crile jehelec	381, 389
Crile svorka na cévy	122
Crile-Rankin svorka na cévy	122
Crile-Wood jehelec	386
Cusco zrcadlo poševní	314
Cusco-suisse zrcadlo poševní	314
Cusco-virgin zrcadlo poševní	314
Cushing hák jemný	250, 251
Cushing pinzeta anatomická	93, 110
Cushing pinzeta chirurgická	93
Cushing-Taylor pinzeta	110

Č

Čepel k transplantačnímu noži Schink	44
Čepel náhradní k adenotomu	39
Čepel náhradní pro La Force	40
Čepel pro nůž transplantační	45
Čepelka skalpelová	29
Čtyřhran pro varixy	35

D

Dale svorka atraumatická	172
Dardik svorka atraumatická	180
Darling rozvěrač	284
Daviel lžička oční s lopatkou	348
De Bakey bulldog svorka atraumatická	149
De Bakey jehelec	383
De Bakey nůžky	59, 82
De Bakey nůžky na cévy	62
De Bakey odsávačka	422
De Bakey pinzeta atraumatická	107, 110
De Bakey svorka atraumatická	157, 159–163, 165, 169, 174, 185
De Bakey-Bahnon svorka atraumatická	165
De Bakey-Carotis bulldog svorka	151
De Bakey-Mosquito svorka atraumatická	154
De Bakey-Pean svorka atraumatická	155
De Bakey-Rankin svorka atraumatická	154
De Bakey-Satinsky bulldog svorka	151
Deaver hák břišní	266, 267
Deaver nůžky chirurgické	50
Déjerine kladívko	22
Dennis-Browne rozvěrač břišní	295
Derf jehelec	385
Derra svorka atraumatická	172
Deschamps jehla	398
Desjardines pátradlo na žlučovod	406
Desjardins svorka na žlučovod	141
Desmarres držátko víček	251
Desmarres pinzeta na chalazia	104
Dieffenbach skalpel oční	32
Dieffenbach svorka na cévy	115
Diethrich jehelec mikro	392
Dietrich svorka atraumatická	171
Dilatátor slzných bodů	412
Dilatátor urologický	425
Dlátka rovné	33, 34
Dláto na nosní plastiku	370
Dláto žlábkové nosní	371
Dláto žlábkové obloukové	369
Dláto žlábkové rovné	369
Doyen nůžky břišní	52
Doyen svorka na prádlo	188
Doyen škrabka na žebra	340
Doyen zrcadlo poševní	315
Drátek pro výtěry	411
Držadlo bez regulace	419
Držadlo háku	296
Držadlo pro zrcadlo Scherback	315
Držadlo s baterií	14
Držadlo s baterií (studené světlo)	18
Držadlo s regulací	419
Držák háku	296
Držátko	406
Držátko drátěných pilek	362
Držátko skalpelových čepelek	27, 28
Držátko zrcátek hrtanových	319
Dubois nůžky gynekologické	53
Durante pinzeta chirurgická	96
Durham jehla podvazovací	399
Duval kleště na plíce	234
Duval pinzeta chirurgická	96

E

Echlin kleště štípací	199
Elektrická pilka na sádrové obvazy	361
Elektroda háčková izolovaná	409, 429
Elevatorium	33, 34
Elschnig pinzeta fixační	101
Elschnig pinzeta na čočkové pouzdro	102
Engel pilka na sádrové obvazy	361
Engl. Modell svorka na prádlo	188
Esmarch nůžky na obvazy	72
Eufrate Pasque jehelec	384
Extraktor kovový	432

F

Farabeuf hák	275
Farabeuf kleště repoziční	232
Farabeuf škrabka	339
Farabeuf-Lambotte kleště repoziční	232
Fasciotom	33, 34
Faure svorka na pobříšnici	146
Favaloro nůžky na cévy	61
Fergusson kleště na držení kostí	227
Fergusson nůžky chirurgické	50
Fergusson svorka	148
Ferris-Smith pinzeta chirurgická	95
Ferris-Smith-Kerrison štípací	214
Fillatoff rámeček na víčkové stehy	379
Finnocchietto rozvěrač břišní	288
Finnocchietto-Baby rozvěrač břišní	288
Finocchietto jehelec	387
Finocchietto svorka na ledviny	140
Finochietto lopatka rozvěrače páteřního	290
Finochietto rozvěrač hrudní	287
Finochietto rozvěrač páteřní	290
Finsen rozvěrač	279
Foerster kleště tamponové	243
Foerster-Ballenger kleště tamponové	242
Fomon nůžky nosní	64
Fomon nůžky preparační	56
Foregger (Wisconsin) laryngoskop	12
Foregger laryngoskop se studeným světlem	16
Foregger laryngoskopová lžice	12, 16
Franz lopatka	297
Franz rám břišní	297
Freer páčidlo na nosní přepážku	333
Freer páčidlo nosní	334
Fréza pro orl	376
Fréza trepanační	375
Friedman kleště štípací na kosti	195
Fritsch hák břišní	263

G

Garrett sonda cévní	408
Garrett sonda tracheální	408
Gelpi rozvěrač	284
Gemini svorka preparační	137
Gerald pinzeta anatomická	94
Gerald pinzeta chirurgická	94
Giertz-Stille kleště na žebra	205
Gil-Vernet hák páteřní	253
Gillies pinzeta chirurgická	96, 109
Glover svorka atraumatická	150, 173
Gluck kleště na žebra	204
Goelet hák	276
Goldman-Fox nůžky na dáseň	73
Gomel nůžky mikro	70
Good nůžky na mandle	64
Gosset rozvěrač břišní	292, 293
Gotfrýd rozvěrač páteřní	289
Graefe háček na duhovku	252
Graefe háček na operaci sílníhání	252

Graefe hák jemný	250
Graefe pinzeta fixační	101
Graefe pinzeta oční	100
Gray svorka na žlučodod	141
Gregory svorka atraumatická	171
Gregory-Soft bulldog svorka	151
Gross-Maier kleště tamponové	241
Gutsch pilka rámová	362
Guyon svorka na ledviny	139

H

Háček	430
Háček na čočkové pouzdro	252
Háček na křídlo nosní	269
Háček na nervy	269
Háček na oční sval	252
Háček na rány	249
Háček na tvrdou plenu mozkovou	269
Háček oční	252
Háček pro plastiku	269
Hák	296
Hák břišní	263
Hák jemný	249, 250
Hák na choanální polypy	272
Hák na plícnici	268
Hák resekční	274
Hák tracheální	273
Halle lžička nosní	347
Halle nůž na nosní plastiku	38
Halle nůžky nosní	64
Halsey jehelec	386
Halsted-Mosquito svorka na cévy	119
Harken svorka atraumatická	166
Harken svorka na cévy	187
Harrington hák břišní	265
Hartmann háček ušní	272
Hartmann kleště na nosní polypy	245
Hartmann kleště na ušní polypy	216
Hartmann svorka	117
Hartmann zrcátko nosní	317, 318
Hartmann zrcátko ušní	316
Hartmann-Halle zrcátko nosní	318
Heaney jehelec	380
Heaney svorka na hysterektomii	143
Heaney-Ballantine svorka na hysterektomii	144
Heath nůžky pro ligaturu	69
Hegar dilatátor hrdla děložního	426
Hegemann-Diethrich nůžky	60
Hegenbarth pinzeta svorkovací	401
Hegenbarth pinzeta šicí	401
Heiss svorka na cévy	133
Heister rozvěrač úst	280
Henley rozvěrač	281
Henning kleště na sádrové obvazy	225
Hercules kleště štípací na drát	221
Herrick svorka na ledviny	139
Heymann nůž na nosní plastiku	38
Heymann nůžky nosní	64
Heywood-Smith kleště tamponové	240
Hirschmann anoskop s obturátorem	321
Hohmann páčidlo	325, 327
Hohmann páka kostní	330, 331
Holbrook-Curtis pilka nosní	363
Hösel jehelec	390
Howarth páčidlo nosní	335
Humby nůž transplantační	45
Hurd škrabka na mandle	342

CH

Chandler rozvěrač hrudní	287
Chaput svorka na cévy	116

I

Iris nůžky micro super cut	78
Israel hák na rány	256
Ives-Fansler anoskop s gumovým obturátorem	321

J

Jabaley-Stille nůžky micro super cut	75
Jacobson jehelec mikro	392, 394
Jaeger destička na víčkové operace	307
Jaeger háček na operaci šilhání	252
Jansen kleště ušní štípací	217
Jansen rozvěrač	279
Javid svorka atraumatická	175
Jehelec	381, 382, 389
Jehelec hloubkový	381, 382, 387
Jehelec mikro	395
Jehelec neurochirurgický	396
Jehelec oční	379
Jehelec pro plastiku	396
Jehelník	436
Jehla epilační	29
Jehla na odběr kostní dřevě	405
Jehla preparační	43
Jehla punkční	415
Jehla šicí	451
Jehla šicí pitevní	399
Jehla zaváděcí	415
Jeweler pinzeta	109
Johns-Hopkins svorka na cévy	115
Jones svorka na prádlo	188
Joseph hák jemný	249
Joseph nůž na nosní plastiku	37, 38
Joseph pilka na kosti	363

K

Kalt pinzeta na čočkové pouzdro	102
Kantrowitz svorka preparační	137
Kanyla laryngeální	420
Kanyla s olivkou	420
Kelly hák břišní	264
Kelly kleště na polypy	240
Kelly nůžky na fistuli	52
Kelly proktoskop s obturátorem	321
Kelly sphinkteroskop s obturátorem	321
Kelly svorka na cévy	122, 131
Kelly-Rankin svorka na cévy	122
Kerrison štípací	215
Kerrison štípací na laminectomii	214
Killian páčidlo nosní	335
Killian zrcátko nosní	317
Kilner jehelec	385
Kilner nůžky preparační	57
Kirschner jehla podvazovací	399
Kirschner lopatka	298
Kirschner rám břišní komplet	298
Kirschner rozvěrač břišní rámový	298
Kladívko chirurgické kovové	367
Kladívko pitevní s hákem	367
Kleinert-Kutz kleště štípací na kosti	198
Kleště Artro	206–208
Kleště dvouháčkové na čípek	237
Kleště na cervix	237
Kleště na držení kostí	228, 229
Kleště na držení kostí repoziční	230
Kleště na hadici	190
Kleště na hemoroidy	235
Kleště na kostní úlomky	227
Kleště na meziobratlové ploténky	211–213
Kleště na nosní skořepu	245
Kleště na žebra	204
Kleště repoziční	231

Kleště štípací	203, 218
Kleště štípací na drát	219, 220, 222
Kleště tamponové	241
Kleště úchopné	218
Kleště úchopné na drát	226
Kleště ušní	244
Klíč	361
Klíč k rámovému rozvěrači	296
Klíček utahovací k držákům skalpelových čepelek	28
Klička na výtěry	43
Klička odměrná	446
Klinikum Berlin svorka na trubice	190
Klinkenbergh-Loth nůžky neurochirurgické	62
Koerte hák na rány	255
Kocher hák břišní	264
Kocher hák na rány	254, 258
Kocher pátradlo na strumu	411
Kocher svorka na cévy	120, 121, 123
Kolibří pinzeta na duhovku	103, 105
König jehla podvazovací	400
König nůžky na nehty	74
Koutný pinzeta na duhovku	101
Krabice	451
Krabice na nástroje	434
Kristeller zrcadlo poševní	312, 313
Kroužek "O" gumový	431
Kuehne pinzeta pro mikroskopická sklíčka	87
Kuhnt pinzeta na čočkové pouzdro	102
Kyreta děložní	355–357

L

L dlátko	33, 34
La Force adenotom	40
La Grange nůžky micro super cut	78
Lahey svorka na žlučod	140
Lambert-Kay svorka atraumatická	165
Lambotte dláto neurochirurgické	372
Lampa čelní	19
Lane pinzeta chirurgická	93
Lane svorka na prádlo	188
Lang lžička oční	348
Lange-Hohmann páka kostní	331
Langenbeck amputační nůž	41
Langenbeck hák na rány	257
Langenbeck jehelec	390
Langenbeck nůž amputační	41
Langenbeck páčidlo	325
Langenbeck škrabka	339
Langenbeck-Delicate jehelec	390
Langenbeck-Ryder jehelec	390
Lawrence svorka preparační	136
Lebsche nástroj na sternum	367
Lees svorka atraumatická	168
Leland-Jones svorka atraumatická	158
Leriche svorka na cévy	120
Lexer nůžky	84
Lexer nůžky preparační	57
Lexer-Baby nůžky preparační	56
List pilky	361, 362
Lister (bandage) nůžky micro super cut	75
Lister kleště tamponové	238
Lister nůžky na obvazy	72, 84
Lister-Excentric nůžky na obvazy	72
Liston kleště štípací	201, 202
Littauer nůžky pro ligaturu	69
Littauer-Liston kleště štípací	203
Löbker kleště na jazyk	246
Lopatka	300
Lopatka břišní	305
Lopatka k rozvěrači páteřnímu	289
Lopatka mozková	307
Lopatka na duhovku	308

Lopatka na mast	305
Lorenz nůžky na obvazy	71
Lorna svorka na prádlo	189
Lower svorka na ledviny	140
Lucae jehla paracentésní	37
Lucae páčka ušní	333
Lucae pinzeta ušní	99
Ludewig háček na kovadlinku	272
Luer kleště štípací na kosti	195–197
Luer-Koerte lžička na žlučové kameny	346
Luer-Stille kleště štípací na kosti	197
Luethy-Beck jehelec	390
Lžice pro zrcadlo Scherback	315
Lžička děložní	347
Lžička na páteř	349
Lžička ortopedická	351
Lžička ostrá	345, 349
Lžička páteřní	351

M

Magill kleště na závádění endotracheálních rourek	226
Markham-Meyerding rozvěrač	284
Markwalder kleště štípací	202
Marquard kleště štípací	198
Maršík pinzeta na mandle	99
Martel svorka na chlopeň	116
Masing páčidlo nosní	335
Masson jehelec	387
Mathieu hák	276
Mathieu jehelec	381, 388, 451
Mathieu-Ryder jehelec	389
Mayfield kleště štípací	198
Mayo nůžky	79
Mayo nůžky preparační	55
Mayo spona na nástroje	437
Mayo-Adams rozvěrač	285
Mayo-Harrington nůžky micro super cut	76
Mayo-Hegar jehelec	380, 383
Mayo-Hegar-Delicate jehelec	380
Mayo-Stille nůžky	80
Mayo-Stille nůžky micro super cut	76
Mayo-Stille nůžky preparační	55
McIndoe nůžky na chrupavku	63
McIndoe pinzeta anatomická	92
McIntosh laryngoskop	11, 15
McIntosh laryngoskopová lžice	11, 15
McKenty páčidlo nosní	334
Meeker svorka na cévy	130
Měřítka	23
Měřítka x-ray	23
Metzenbaum jehelec	389
Metzenbaum nůžky	80, 81
Metzenbaum nůžky micro super	77
Metzenbaum nůžky preparační	54
Metzenbaum-Delicate nůžky	83
Metzenbaum-Delicate nůžky preparační	54
Metzenbaum-Nelson nůžky preparační	54
Meyhöfer lžička na chalazia	348
Micro-Adson pinzeta anatomická	92
Micro-Adson pinzeta chirurgická	92
Micro-bulldog svorka na cévy	114
Micro-Mosquito svorka na cévy	119
Microvascular jehelec	384
Middeldorpf hák na rány	260
Michel pinzeta šicí	401
Michel svorka šicí	401
Mikulicz hák břišní	265
Mikulicz svorka na pobřišnici	146
Miller laryngoskop	13, 17
Miller laryngoskopová lžice	13, 17
Mini-Friedman kleště štípací na kosti	195
Mini-Hohmann páka kostní	329

Mini-Langenbeck hák	251	Ollier škrabka exartikulační	341
Miska	434, 435	Olsen-Hegar jehelec/nůžky	380, 388
Miskimon rozvěrač	282	Overholt svorka na cévy	129
Mixer svorka preparační	135	Overholt svorka na lobektomii	128
Mixer-O'Shaughnessy svorka preparační	135	Overholt-Geissendoerfer svorka na cévy	128
Mod. Wien zrcátko nosní	318	Overholt-Mixer svorka na cévy	132
Moeltgen goniometr	23		
Mollison rozvěrač	282	P	
Morris-De Bakey svorka atraumatická	170	Páčidlo	326–328
Mosquito-Halstead svorka na cévy	118	Páčidlo na nosní přepážku	333
Müller rozvěrač ran oční	279	Páčka ušní	333
		Pagenstecher lopatka na hmotu čočky	308
N		Páka kostní	329
Nabatoff soubor sond na křečové žíly	406	Páka na lebku	367
Naběračka pro anatomii	22	Páka poševní	311, 312
Nádobka pro přípravu vzorků	446	Parametrium nůžky	79
Náhradní žárovka	19	Parametrium svorka	147
Nálevka	434	Parker hák	275, 276
Nástroj na cizí tělesa v rohovce	32	Parker-Langenbeck hák	276
Nástroj na vyhlazení čela	306	Pátradlo děložní	409
Negus svorka na žlučovou	141	Pátradlo nosní	411
Nelson pinzeta úchopná	96	Pátradlo paličkové	405, 441
Nelson trokar	418	Pátradlo ušní	411
New Orleans jehelec	385	Pátradlo žlábkové	405, 451
Northbent nůžky pro ligaturu	69	Payr jehla podvazovací	400
Notto kleště na polypy	239	Pean svorka na cévy	117, 120, 123
Novák kleště na držení kostí	230	Pean svorka preparační	122
Noyes nůžky na duhovku	67	Peers svorka na prádlo	189
Nůž háčkový	430	Peet pinzeta na třísky	98
Nůž k protínání příčného vazů zápěstního	31	Pelkmann kleště tamponové	240
Nůž klapův	35	Percy talíř amputační	302
Nůž na flegmonu	38	Petz svorka šicí	402
Nůž na furunkl s kyretou	37	Phaneuf svorka na hysterektomii	144
Nůž na chrupavku	42	Pilník	364
Nůž na meniskus	43	Pinzeta anatomická	88–90, 92, 109, 441
Nůž na varixy	33	Pinzeta bajonetová anatomická	99
Nůž pitevni	42	Pinzeta bipolární	108
Nůž resekcí	31	Pinzeta cévní atraumatická	106
Nůž trojúhelníkový	430	Pinzeta enukleační	103
Nůž vypichovací na varixy	35	Pinzeta epilační	87
Nůžky anatomické	63	Pinzeta chirurgická	88, 89, 91, 451
Nůžky enukleační	66	Pinzeta jemná šicí	87
Nůžky chirurgické	49–51, 441, 451	Pinzeta na duhovku anatomická	101
Nůžky mikro	69, 70	Pinzeta na duhovku chirurgická	101
Nůžky na dáseň	73	Pinzeta na keratoplastiku	105
Nůžky na duhovku	84	Pinzeta na operaci šilhání	104
Nůžky na incisi	49	Pinzeta na plastiku	87
Nůžky na kosti	49	Pinzeta na rohovku šicí	104
Nůžky na měkké obvazy	71	Pinzeta na řasy	105
Nůžky na nehtovou kůžičku	74	Pinzeta na třísky	98
Nůžky na nehty	74	Pinzeta šicí	97, 105
Nůžky na sádrové obvazy	72	Pinzeta technická	98
Nůžky na střeva	63	Plester rozvěrač	285
Nůžky na stříhání vlasů	71	Pohár na moč	446
Nůžky neurochirurgické	61	Politzer nůž na furunkl	37
Nůžky oční	65–67	Politzer zrcátko ušní	316
Nůžky preparační	55–58	Poole odsávačka	422
Nůžky preparační dětské	57	Potts svorka atraumatická	156
		Potts-De Dartel nůžky na cévy	62
O		Potts-Smith jehelec	392
O'Sullivan-O'Connor lopatka	296	Potts-Smith nůžky	59, 82
O'Sullivan-O'Connor rám břišní	296	Potts-Smith pinzeta anatomická	94
Odsávačka lomená	419, 420	Pouzdro vodící	430
Odsávačka oblouková	419	Pratt svorka na hemeroidy	148
Odsávačka s regulací	421	Pratt zrcadlo rektální	320
Odsávačka silně zahnutá	419	Presbyterian svorka na trubice	190
Odsávačka zahnutá	420	Prince nůžky na mandle	64
Oehler pinzeta chirurgická	109	Providence-Hospital svorka na cévy	120
Ochsner svorka atraumatická	171	Přecechtěl škrabka nosní	342
Ochsner-Kocher svorka na cévy	126, 127	Přechodka Luer	420
Olivercraone pilka drátěná	362	Putti rašple	364
Olivka	406		

Q

Quinby nůžky na dáseň 73

R

Rabiner kladívko 21
 Rám drážkový 296
 Rampley kleště tamponové 243
 Randall kleště na ledvinové kameny 236
 Recamier lžička děložní 347
 Redonova jehla 416
 Rehn nůž transplantační 44
 Reiner nůž na sádrové obvazy 41
 Reverdin jehla 397
 Reverdin lopatka břišní 305
 Reynolds nůžky preparační 58
 Ricard rozvěrač břišní 301
 Rigby rozvěrač ran 285
 Richardson hák na rány 260
 Richardson-Eastman hák na rány 261
 Richter nůžky chirurgické 49
 Roberts svorka na cévy 133
 Roeder svorka na prádlo 189
 Rochard rozvěrač břišní 298
 Rochester-Carmal svorka na cévy 131
 Rochester-Ochsner svorka na cévy 121
 Rochester-Pean svorka na cévy 124, 125, 441, 451
 Roser-König rozvěrač út 280
 Rouška pro dýchání z plic do plic 447
 Roux hák 275
 Rozvěrač 279
 Rozvěrač břišní na operaci jater 299
 Rozvěrač břišní řetízkový 301
 Rozvěrač pro laminekotimii 291
 Rozvěrač ran 280, 281, 285, 286
 Rozvěrač se stavitelným háky 296
 Rozvěrač víček kojenecký 280
 Rozvěrač víček mikro 280
 Rumel svorka preparační 134
 Ruskin kleště štípací 196, 200
 Russ. Modell pinzeta chirurgická 96
 Ryder/French-Eye jehelec 384

S

Sada čelistí pro štípací kleště Hercules 221
 Sachs uvolňovač tvrdé pleny 332
 Santulli bulldog svorka atraumatická 149
 Sanvenero nůžky preparační 58
 Sarot jehelec 387
 Sarot svorka na cévy 133
 Satinsky nůžky neurochirurgické 62
 Satinsky svorka atraumatická 164
 Satinsky svorka cévní 187
 Sauerbruch jehelník 436
 Sauerbruch kleště na žebra 204
 Sauerbruch škrabka 341
 Sauerbruch-Frey kleště na žebra 205
 Segond nůž na myomy 36
 Semb hák na rány 262
 Semb uvolňovač 138
 Semken pinzeta anatomická 92, 109
 Semken pinzeta chirurgická 92
 Semm rozvěrač břišní 295
 Senn-Miller hák páteří 253
 Senning (Swed. Mod) jehelec 385
 Seutin nůžky na sádrové obvazy 72
 Schaedel svorka na prádlo 188
 Scherback zrcadlo poševní 315
 Schink nůž transplantační 44
 Schmieden-Payr jehla podvazovací 400
 Schmieden-Taylor nůžky neurochirurgické 62
 Schnidt-Sawtell svorka na cévy 131

Schröder kleště 237
 Schwartze háček ušní 272
 Schwartze jehla paracentésní 37
 Schwartze tenotom ušní 37
 Siebolt nůžky děložní 53
 Silver dláto na nosní plastiku 370
 Sims nůžky gynekologické 53
 Sims pátradlo děložní 409
 Sims zrcadlo rektální 320
 Singley-Tuttle pinzeta chirurgická 96
 Síto sterilizační 442
 Skalpel s dlouhým krčkem 31
 Skalpel s hranatým držadlem 31, 36
 Skalpel s plochým držadlem 30, 441, 451
 Smellie hák dekapitační a porodnický 271
 Smith (mod. USA) nůžky na obvazy 71
 Smith-Peterson kleště štípací 200
 Smyčka drátěná 358
 Sonda kovová 406
 Sonda oční dutá 412
 Sonda plastová 406
 Sonda urologická 410
 Soubor nástrojů na protětí příčného vazů zápěstí 430
 Soubor pro mediky 441
 Soubor pro operaci varixů 33
 Soubor veterinární šicí 451
 Souprava pro odběr krve a moče 445
 Souprava pro odběr sputa 445
 Souprava pro odběr stolice 445
 Spencer nůžky pro ligaturu 69
 Stacke dláto ušní žlábkové 371
 Stacke chránič dlátek 367
 Stacke nůž na zvukovod 38
 Standard trokar 417
 Stellbrink kleště štípací na kosti 195
 Sternum jehelec 391
 Stevens nůžky micro super cut 75
 Stevens nůžky oční 66
 Stieglitz pinzeta na třísky 98
 Stille dláto ploché 368
 Stille dláto poloklínové 368
 Stille kleště na sádrové obvazy 225
 Stille nůžky micro super cut 75
 Stille svorka na ledviny 139
 Stille-Barraya pinzeta chirurgická 95
 Stille-Mayo nůžky micro super cut 76
 Stille-Rangell nůžky micro super cut 76
 Stille-Ruskin kleště štípací 199
 Stripper 33, 34
 Strully nůžky neurochirurgické 61
 Strümpel kleště na ušní polypy 217
 Subramanian svorka atraumatická 186
 Subramanian-miniature svorka atraumatická 186
 Svorka atraumatická 152, 153, 173, 182–184
 Svorka na hemoroidy 431
 Svorka na střeva 145
 Svorka na trubice 190
 Svorka na uzavírání sáčků s krví 191
 Svorka pro svorky Bulldog 115

Š

Škrabka 340, 363
 Škrabka exartikulační 340, 342
 Škrabka na operaci slzného vaku 342
 Škrabka na rohovku 342

T

Tác 435
 Taylor páka kostní 332
 Taylor pinzeta anatomická 93
 Taylor pinzeta chirurgická 93
 Taylor reflexní kladívko 21

Thiersch nůž transplantační	44	Zavaděč	406
Thorek nůžky preparační	56	Zavaděč drátěných pilek	362
Tieck-Halle zrcátko nosní	318	Zavaděč pouzdra vodícího	430
Toennis nůžky neurochirurgické	61	Závaží pro zrcadlo Scherback	315
Toennis svorka preparační	137	Zenker svorka preparační	134
Toennis-Adson-Delicate nůžky	84	Zielke štípák meziobratlový	210
Tohoku-Japan svorka na prádlo	189	Zkumavka jednorázová	446
Toulec	433	Zkumavka na mléko	445
Toulec na kleště s podstavcem	433	Zkumavka pro analyzátor	446
Toulec na pinzety s podstavcem	433	Zkumavka pro standardizaci	446
Troeltsch hák na zvukovod	272	Zrcadlo čelní	19
Troeltsch pinzeta nosní	99	Zrcátko hrtanové	319
Troeltsch pinzeta ušní	99	Ž	
Troemner kladívko	22	Žárovka halogenová	18
Trousseau rozvěrač trachey	426	Žárovka malá do laryngoskopu	14
Tuffier lopatka na ledviny	307		
Tuffier svorka na cévy	116		
U			
Ulrich kleště na polypy	238		
Universal nůžky na drát	84		
Universal nůžky na obvazy	71		
Uvolňovač na preparaci nervů	332		
Uvolňovač zahnutý	138		
V			
V. Petz břišní a střevní sešívací aparát	402		
Verbrugge kleště repoziční	233		
Verhoff pinzeta na čočkové pouzdro	103		
Víčko ke zkumavce na mléko	445		
Virchow nůž pitevni na mozek dvojbřitý	42		
Vnitřní krabička pro jehelník	436		
Volkman hák na rány	254, 255		
Volkman lžička	346		
Vrtačka kolovrátková	375		
W			
Wagner nůžky	64		
Waldmann nůžky pro episiotomii	52		
Walton rozvěrač ran páteřní	286		
Walton-Liston kleště štípací	203		
Wangensteen jehelec	387		
Wangensteen pinzeta	95		
Wangensteen pinzeta chirurgická	110		
Weber klička oční	308		
Weber rozvěrač víček	280		
Weber svorka atraumatická	167		
Webster jehelec	386		
Weitlaner rozvěrač	281		
Wertheim nůžky břišní	52		
Wertheim svorka na hysterektomii	142, 143		
Wertheim-Cullen svorka na hysterektomii	144		
West dláto nosní	371		
Westcott nůžky na rohovku	68		
Wigmore pilka na sádrové obvazy	361		
Willet-Martel svorka na chlopeň	116		
Williger páčidlo	325		
Williger škrabka	339		
Winter kleště potratové	237		
Wolff kleště na drčení sádrových obvazů	225		
Wolff kleště na sádrové obvazy	225		
Wullstein rozvěrač	282		
Y			
Yankauer odsávačka	422		
Yasargil pinzeta na nádory	97		
Young hák na prostatu	270, 271		
Z			
Zahradníček páčidlo	325		
Zaufal-Jansen kleště štípací na kosti	198		

A

Abdominal retractor	263
Abdominal retractor for liver operation	299
Abdominal spatula	305
Accumulator insert for battery handle	14
Adenotom blade	39
Adlerkreutz tissue forceps	95
Adson artery forceps	130
Adson dressing forceps	92
Adson forceps TUC	110
Adson retractor	286
Adson tissue forceps	92
Adson-Brown tissue forceps	92
Agnew paracentesis needle	37
Allis intestinal forceps	235
Allis tissue forceps	114
Allison lung spatula	305
Alm retractor	279
Anatomical forceps	99
Anatomy ladle	22
Anderson-Adson retractor	282
Arruga capsule forceps	102
Artery forceps atraumatic	152, 153
Arthro forceps	206–208
Atrauma forceps	173, 182–184
Aural probe	411
Ayer uterine raspatory	342

B

Babcock probe	408
Babcock tissue seizing forceps	114
Babinsky percussion hammer	21
Baby Metzenbaum scissors micro super cut	77
Baby-Adson artery forceps	130
Baby-Crile-Wood needle holder	386
Baby-Mikulicz peritoneal clamp-forceps	146
Baby-Mixer dissecting forceps	135
Baby-Poole suction tube	422
Baby-Ssatinsky vena-ceva forceps	187
Backhaus forceps	188
Backhaus paper forceps	188
Backhaus towel forceps	189
Backhaus-Clip towel forceps	189
Baflour abdominal retractor	294
Baginsky laryngeal knife	38
Bainbridge artery forceps	131
Bainbridge atrauma forceps	158
Bakeš gall duct probe	407
Balfour abdominal retractor	294
Balfour-Baby abdominal retractor	294
Ballenger knife for septum	39
Barraquer eye scissors	67
Barraquer micro-needle holder	393
Bartl nail extraction forceps	227
Battery handle	14
Beck atrauma forceps	173, 179
Beckmann adenoid curette	39
Beckmann retractor	283
Beckmann-Eaton retractor	283
Beer cilia forceps	105
Beeson plaster cast spreader	225
Bengolea artery forceps	132
Bensaude anoscope with obturator	321
Berliner neurological reflex hammer	22
Bernhard towel forceps	188

Berry wire twisting forceps	391
Berthold ear hook	272
Bethune rib forceps	204
Beyar bone ronguers	198
Bipolar forceps	108
Blade	300
Blade for Scherback speculum	315
Blade for transplantation knife	45
Blade for transplantation knife Schink	44
Blade of spinal retractor	289
Blades	29
Blascovics strabismus forceps	104
Blount bone elevator	332
Blount meniscus hook	273
Blumenthal bone ronguers	195
Böhler bone ronguers	198
Bone cutter	375
Bone elevator	329
Bone file	364
Bone forceps	228, 229
Bone holding forceps	230
Bone marrow extraction needles	405
Bone ronguers	203
Bone scissors	49
Bonefone capsule forceps	103
Bonney tissue forceps	96, 110
Bowl	434, 435
Bowmann eye probe	411
Box	451
Box for instruments	434
Boynton eye needle holder	379, 390
Bozemann sponge holding forceps	239
Brain spatula	307
Braun-Stadler episiotomy scissors	52
Bridge dissecting forceps	136
Brown tissue forceps	94
Bruenings tonsil snare	358
Brunner ligature needle	399
Brunner retractor	259
Brunner rib forceps	205
Brünnings tongue spatula	307
Bruns plaster-of-paris shears	72
Buck percussion hammer	21
Buelau trocar	418
Buchwald tongue spatula	307
Bulb halogen	18
Bulb krypton	18
Bunge exenteration spoon	348

C

Cable flexible	406
Caldwell-Luc retractor	261
Capslule hook blunt	252
Cartilage knife	42
Castroviejo corneal forceps	104
Castroviejo delicate eye scissors	68
Castroviejo eye scissors	67
Castroviejo iris scissors	67
Castroviejo micro-needle holder	392, 394
Castroviejo needle holder	391, 392
Catlin amputating knife	41
Chain abdominal retractor	301
Chandler pectoral retractor	287
Chaput artery forceps	116
Chisel	33, 34
Choanal hook	272

Cilia forceps	105	Desjardines gall duct probe	406
Clar	20	Desjardins gall duct clamp	141
Cleveland bone ronguers	195, 203	Desmarres delicate hook	251
Cleveland-Gardner bone ronguers	202	Desmarres chalazion forceps	104
Cloward spoon	350	Dieffenbach artery forceps	115
Collin abdominal retractor	300	Dieffenbach bulldog clamps	115
Collin amputating knife	41	Dieffenbach operating knife	32
Collin clip forceps	401	Diethrich micro-needle holder	392
Collin dressing forceps	239	Dietrich atrauma forceps	171
Collin dynamometer	23	Dissecting forceps curved	138
Collin retractor	293	Dissecting needle	43
Collin tongue holding forceps	246	Dissecting scissors	55–58, 63
Collin tumor forceps	235	Dissection micro scissors	70
Collin-Baby abdominal retractor	300	Double foreign body instrument	32
Collin-Duval grasping forceps	95	Doyen abdominal scissors	52
Conductor for wire saws	362	Doyen rib raspatory	340
Cone retractor	283	Doyen towel forceps	188
Connecting piece Luer	420	Doyen vaginal speculum	315
Cooley atrauma forceps	175–178, 181	Dressing forceps	88–90, 92, 441
Cooley-Derra atrauma forceps	179	Dubois cephalotomy scissors	53
Corneal scarifier	342	Dura hook	269
Corneal suturing forceps	104	Durante tissue forceps	96
Coryllos rib forceps	204	Durham ligature needle	399
Cottle Kazanjian bone ronguers	202	Duval lung grasping forceps	234
Cottle nasal elevator	334, 335	Duval tissue forceps	96
Cottle nasal scissors	64		
Crafoord artery forceps	133	E	
Crafoord lobectomy scissors	63	Ear elevator	333
Crafoord-Sellors bronchus forceps	132	Ear forceps	244
Crile artery forceps	122	Echlin bone ronguers	199
Crile needle holder	381, 389	Electrode	409, 429
Crile-Rankin artery forceps	122	Elevator	326–328
Crile-Wood needle holder	386	Elevatorium	33, 34
Cusco vaginal speculum	314	Elschnig capsule forceps	102
Cusco-Suisse vaginal speculum	314	Elschnig fixation forceps	101
Cusco-Virgin vaginal speculum	314	Engel plaster-of-paris saw	361
Cushing delicate hook	250, 251	Engl. Modell towel forceps	188
Cushing dressing forceps	93	Ent burr-drill	376
Cushing forceps	110	Enterotomy scissors	63
Cushing tissue forceps	93	Enucleation forceps	66, 103
Cushing-Taylor forceps	110	Esmarch bandage scissors	72
Cuticle scissors	74	Eufrate Pasque needle holder	384
Cylindrical cutter	375	Extractor	432
		Eye dilator	412
D		Eye hook	252
Dale atrauma forceps	172	Eye probe	412
Dardik atrauma forceps	180	Eye scissors	65, 66
Darling retractor	284	Eye scissors for cornea	67
Daviel eye spoon with spatula	348		
De Bakey artery scissors	62	F	
De Bakey atrauma bulldog clamp	149	Farabeuf raspatory	339
De Bakey atrauma forceps	107, 110, 157, 159–163, 165, 169, 174, 185	Farabeuf reposition forceps	232
De Bakey needle holder	383	Farabeuf retractor	275
De Bakey scissors	82	Farabeuf-Lambotte reposition forceps	232
De Bakey suction tube	422	Fasciotom	33, 34
De Bakey vascular scissors	59	Faure peritoneal clamp-forceps	146
De Bakey-Bahnsen atrauma forceps	165	Favaloro artery scissors	61
De Bakey-Carotis bulldog clamp	151	Fergusson angiotribe clamp	148
De Bakey-Mosquito atrauma forceps	154	Fergusson bone holding forceps	227
De Bakey-Pean atrauma forceps	155	Fergusson operating scissors	50
De Bakey-Rankin atrauma forceps	154	Ferris-Smith tissue forceps	95
De Bakey-Satinsky bulldog clamp	151	Ferris-Smith-Kerrison laminectomy rongeurs	214
Deaver operating scissors	50	Fillatoff frame for eye ligature	379
Deaver retractor	266, 267	Finnocchietto rip spreader	288
Dejérine percussion hammer	22	Finnocchietto-Baby rip spreader	288
Delicate hook	249, 250	Finnocchietto kidney pedicle forceps	140
Dennis-Browne abdominal retractor	295	Finnocchietto needle holder	387
Depilation forceps	87	Finochietto blade of spinal retractor	290
Depilation needle	29	Finochietto pectoral retractor	287
Derf needle holder	385	Finochietto spinal retractor	290
Derra atrauma forceps	172	Finsen retractor	279
Deschamps ligature needle	398	Foerster sponge holding forceps	243

Foerster-Ballenger forceps	242	Handle for laryngeal mirror	319
Fomon dissecting scissors	56	Handle for Scherback speculum	315
Fomon nasal scissors	64	Handle with regulation	419
Forceps	109	Handle without regulation	419
Forceps for closing bags	191	Harken atrauma forceps	166
Forceps quiver	433	Harken vena-ceva forceps	187
Foregger (Wisconsin) laryngoscope	12	Harrington retractor	265
Foregger blades	12	Hartmann ear hook	272
Foregger fibre optic blade	16	Hartmann ear polypus forceps	216
Foregger fibre optic laryngoscope	16	Hartmann ear speculum	316
Franz abdominal retractor	297	Hartmann for children	316
Franz frame	297	Hartmann forceps	117
Franz retractor	297	Hartmann nasal polypus forceps	245
Freer nasal elevator	334	Hartmann nasal speculum	317, 318
Freer septum elevator	333	Hartmann-Halle nasal speculum	318
Friedman bone ronguers	195	Head light	19
Fritsch abdominal retractor	263	Head mirror	19
Fritsch retractor	263	Heaney hysterectomy clamp-forceps	143
Funnel	434	Heaney needle holder	380
Furuncle knife with curette	37	Heaney-Ballantine clamp-forceps	144
G		Heath ligature scissors	69
Garrett tracheal dilatator	408	Hegar uterine dilator	426
Garrett vascular dilatator	408	Hegemann-Diethrich vascular scissors	60
Gelpi retractor	284	Hegenbarth forceps for clips	401
Gemini dissecting and ligature forceps	137	Hegenbarth suture forceps	401
Gerald dressing forceps	94	Heiss artery forceps	133
Gerald tissue forceps	94	Heister mouth retractor	280
Giertz-Stille forceps for ribs	205	Hemorrhoidal applicator	431
Gil-Vernet spinal hook	253	Hemorrhoidal forceps	431
Gillies tissue forceps	96, 109	Henley exchangeable blade	281
Glass for urine	446	Henley retractor	281
Glover atrauma clamp	150	Henning plaster cast spreader	225
Glover atrauma forceps	173	Hercules wire cutting forceps	221
Gluck pulling forceps for ribs	204	Herrick kidney pedicle clamp-forceps	139
Goelet retractor	276	Heymann nasal plastic knife	38
Goldman-Fox scissors	73	Heymann nasal scissors	64
Gomel dissection micro scissors	70	Heywood-Smith forceps	240
Good tonsil scissors	64	Hirschmann anoscope with obturator	321
Gosset abdominal retractor	292, 293	Hoesel needle holder	390
Gotfrýd spinal retractor	289	Hohmann bone elevator	330, 331
Gouge	369	Hohmann elevator	325, 327
Graefe delicate hook	250	Holbrook-Curtis nasal saw	363
Graefe eye forceps	100	Holder frame	296
Graefe fixation forceps	101	Hook	296, 430
Graefe iris hook	252	Hook handle	296, 362
Graefe strabismus hook	252	Hook holder	296
Grasping forceps	218	Hook retractor	296
Gray gall duct clamp	141	Howarth nasal elevator	335
Gregory atrauma forceps	171	Humby transplantation knife	45
Gregory-Soft bulldog clamp	151	Hurd tonsil raspatory	342
Gross-Maier sponge holding forceps	241	I	
Guide for sleeve	430	Incision scissors	49
Guide needle	415	Instruments for cutting of wrist ligaments	430
Guide sleeve	430	Inter box for needle case	436
Gum O-ring for applicator	431	Intestinal forceps	145
Gum scissors	73	Iris forceps	101
Gutsch bone saw	362	Iris scissors	84
Guyon kidney pedicle clamp-forceps	139	Iris scissors micro super cut	78
Gynaecological forceps	237	Iris spatula curved	308
H		Israel retractor	256
Haemorrhoids forceps	235	Ives-Fansler anoscope with rubber obturator	321
Hair scissors	71	J	
Halle nasal plastic knife	38	Jabaley-Stille scissors micro super cut	75
Halle nasal scissors	64	Jacobson micro-needle holder	392, 394
Halle nasal spoon	347	Jaeger eye lid plate	307
Halsey needle holder	386	Jaeger strabismus hook	252
Halsted-Mosquito artery forceps	119	Jansen mastoid forceps	217
Hand drill	375	Jansen retractor	279
Handle	406	Javid atrauma forceps	175
Handle fibre optic battery	18	Jeweler forceps	109

Johns-Hopkins bulldog clamp	115
Jones towel forceps	188
Joseph delicate hook	249
Joseph nasal plastic knife	37, 38
Joseph nasal rasp	363

K

Kalt capsule forceps	102
Kalt capsule micro forceps	105
Kantrowitz dissecting and ligature forceps	137
Kelly artery forceps	122, 131
Kelly fistula scissors	52
Kelly polypus forceps	240
Kelly proctoscope with obturator	321
Kelly retractor	264
Kelly sphincteroscope with obturator	321
Kelly-Rankin artery forceps	122
Keratoplastic forceps	105
Kerrison laminectomy punches	215
Kerrison laminectomy rongeurs	214
Key for holder frame	296
Killian nasal elevator	335
Killian nasal speculum	317
Kilner dissecting scissors	57
Kilner needle holder	385
Kirschner abdominal retractor	298
Kirschner ligature needle	399
Kirschner retractor	298
Kleinert-Kutz bone rongeurs	198
Klinikum Berlin tubing clamp	190
Klinkenbergh-Loth artery scissors	62
Knife	430
Knife for slashing carpal ligament	31
Knife for varices	33
Knife klapuv	35
Koerte retractor	255
Kocher abdominal retractor	258, 264
Kocher artery forceps	120–121, 123
Kocher goitre probe	411
Kocher retractor	254, 258, 264
Kolibri iris forceps	103
Kolibri iris micro forceps	105
König ligature needle	400
König nail splitting scissors	74
Koutný iris forceps	101
Kristeller vaginal speculum	313
Kuehne clamp for microscopic slides	87
Kuhnt capsule forceps	102

L

L-chisel	33, 34
La Force adenotom	40
La Grange scissors micro super cut	78
Lahey gall duct clamp	140
Lachrymal sac raspatory	342
Lambert-Kay atrauma forceps	165
Lambotte neurosurgical osteotom	372
Laminectomy retractor	291
Laminectomy rongeurs	211–213
Lane tissue forceps	93
Lane towel forceps	188
Lang eye spoon	348
Lange-Hohmann bone elevator	331
Langenbeck amputating knife	41
Langenbeck elevator	325
Langenbeck needle holder	390
Langenbeck raspatory	339
Langenbeck retractor	257
Langenbeck-Delicate needle holder	390
Langenbeck-Ryder needle holder	390
Laryngeal cannula	420
Laryngeal mirror	319

Laryngoscope bulb	14
Lawrence dissecting forceps	136
Lebsche sternum chisel	367
Lees atrauma forceps	168
Leland-Jones atrauma forceps	158
Leriche artery forceps	120
Lexer dissecting scissors	57
Lexer scissors	84
Lexer-Baby dissecting scissors	56
Lid for test tube for milk	445
Lid retractor for infants	280
Lid retractor micro	280
Lifting instrument	306
List of saw	362
Lister (bandage) scissors micro super cut	75
Lister bandage scissors	72, 84
Lister sinus forceps	238
Lister-Excentric scissors	72
Liston bone rongeurs	201, 202
Littauer ligature scissors	69
Littauer-Liston bone rongeurs	203
Löbker tongue holding forceps	246
Lorenz bandage scissors	71
Lorna towel forceps	189
Lower kidney pedicle forceps	140
Lucae ear anatomical forceps	99
Lucae ear elevator	333
Lucae paracentesis needle	37
Ludewig incus hook	272
Luer bone rongeurs	195–197
Luer-Koerte gall stone scoop	346
Luer-Stille bone rongeurs	197
Luethy-Beck needle holder	390

M

Magill catheter introducing forceps	226
Mallet	367
Markham-Meyerding retractor	284
Markwalder bone rongeurs	202
Marquard bone rongeurs	198
Maršik tonsil forceps	99
Martel flap forceps	116
Masing nasal elevator	335
Mask for breathing	447
Masson needle holder	387
Mastoid forceps	218
Mathieu needle holder	381, 388, 451
Mathieu retractor	276
Mathieu-Ryder needle holder	389
Mayfield bone rongeurs	198
Mayo dissecting scissors	55, 79
Mayo safety pins	437
Mayo-Adams retractor	285
Mayo-Harrington scissors micro super cut	76
Mayo-Hegar needle holder	380, 383
Mayo-Hegar-Delicate needle holder	380
Mayo-Stille dissecting scissors	55
Mayo-Stille scissors	80
Mayo-Stille scissors micro super cut	76
McIndoe cartilage scissors	63
McIndoe dressing forceps	92
McIntosh blades	11
McIntosh fibre optic blade	15
McIntosh fibre optic laryngoscope	15
McIntosh laryngoscope	11
McKenty nasal elevator	334
Measuring instrument	23
Measuring instrument x-ray	23
Measuring loop	446
Meeker artery forceps	130
Meniscus knife	43
Metzenbaum dissecting scissors	54

Metzenbaum needle holder	389	Operating knife for gynaecology	36
Metzenbaum scissors	80, 81	Oscillating plaster-saw	361
Metzenbaum scissors micro super cut	77	Overholt artery forceps	129
Metzenbaum-Delicate scissors	54, 83	Overholt lobectomy forceps	128
Metzenbaum-Nelson dissecting scissors	54	Overholt-Geissendoerfer forceps	128
Meyhöfer chalazion spoon	348	Overholt-Mixter artery forceps	132
Micro scissors	69		
Micro-Adson dressing forceps	92	P	
Micro-Adson tissue forceps	92	Pagenstecher lens spatula	308
Micro-bulldog artery forceps	114	Parametrium clamp	147
Micro-Mosquito artery forceps	119	Parametrium scissors	79
Micro-needle holder	379, 395	Parker retractor	275, 276
Microvascular needle holder	384	Parker-Langenbeck retractor	276
Middeldorf retractor	260	Payr ligature needle	400
Michel clip forceps	401	Pean artery forceps	117, 120, 123
Michel clips	401	Pean dissecting forceps	122
Michel suture forceps	401	Peers towel forceps	189
Mikulicz abdominal retractor	265	Peet splinter forceps	98
Mikulicz peritoneal clamp-forceps	146	Pelkmann dressing forceps	240
Mikulicz retractor	265	Percy amputation shield	302
Miller blade	13	Petz clips	402
Miller fibre optic blade	17	Phaneuf hysterectomy forceps	144
Miller fibre optic laryngoscope	17	Phlegmon knife	38
Miller laryngoscope	13	Plaster scissors	71
Mini-Friedman bone ronguers	195	Plaster-of-paris shears	72
Mini-Hohmann bone elevator	329	Plastic hook	269
Mini-Langenbeck retractor	251	Plester retractor	285
Miskimon retractor blunt	282	Pleura retractor	268
Mixter dissecting forceps	135	Poking knife for varices	35
Mixter-O'Shaughnessy dissecting forceps	135	Politzer ear speculum	316
Mod. Wien nasal speculum	318	Politzer furuncle knife	37
Moeltgen goniometer	23	Poole suction tube	422
Mollison retractor	282	Post mortem hammer with hook	367
Morris-De Bakey atrauma forceps	170	Post mortem knife	42
Mosquito-Halsted artery forceps	118	Post mortem suturing needle	399
Müller eye retractor	279	Potts atrauma forceps	156
		Potts-De martel artery scissors	62
N		Potts-Smith dressing forceps	94
Nabatoff varicose vein probe	406	Potts-Smith micro-needle holder	392
Nail scissors	74	Potts-Smith scissors	82
Nasal alar hook	269	Potts-Smith tissue forceps	94
Nasal gouge	371	Potts-Smith vascular forceps	59
Nasal plastic chisel	370	Pratt haemorrhoidal forceps	148
Nasal probe	411	Pratt rectal speculum	320
Nasal septum forceps	245	Presbyterian tubing clamp	190
Needle case	436	Prince tonsil scissors	64
Needle holder	379, 381, 382, 387, 389	Probe	405, 406, 451
Needle holder for plastic surgery	396	Probe olive	405
Negus gall duct clamp	141	Probe olive with chisel	405, 441
Nelson grasping forceps	96	Providence-Hospital artery forceps	120
Nelson trocar	418	Přecechtěl nasal raspatory	342
Nerve elevator	332	Puncture needle	415
Nerve hook	269	Putti rasp	364
Neurosurgical needle holder	396		
Neurosurgical scissors	61	Q	
New Orleans needle holder	385	Quinby gum scissors	73
Non-traumatic forceps	106	Quiver	433
Northbent ligature scissors	69		
Notto polypus forceps	239	R	
Novak bone holding forceps	230	Rabiner percussion hammer	21
Noyes iris scissors	67	Rampléy sponge holding forceps	243
		Randall kidney stone forceps	236
O		Rasp	363
O'Sullivan-O'Connor abdominal retractor	296	Raspatory	340, 342
Oehler tissue forceps	109	Recamier uterine spoon	347
Ochsnar atrauma forceps	171	Redon needle	416
Ochsnar-Kocher artery forceps	126, 127	Rehn transplantation knife	44
Olive	406	Reiner plaster knife	41
Olivercrone wire saw	362	Reposition forceps	231
Ollier raspatory	341	Resection hook	274
Olsen-Hegar needle holder/scissors	380, 388	Resection knife	31
Operating knife	30, 31, 441, 451	Retractor	249, 279-280, 285, 286

Reverdin abdominal spatula	305	Small container for sample preparation	446
Reverdin needle	397	Smellie decapitation hook	271
Reynolds dissecting scissors	58	Smith (mod. USA) bandage scissors	71
Rib Forceps	204	Smith-Peterson bone ronguers	200
Ricard abdominal retractor	301	Spanner	361
Rigby retractor	285	Spanner for scalpel blade holder	28
Richardson retractor	260	Spare blade for La Force adenotom	40
Richardson-Eastman retractor	261	Spare lamp	19
Richter operating scissors	49	Spencer ligature scissors	69
Roberts artery forceps	133	Spinal spoon	349, 351
Roeder towel forceps	189	Splinter forceps	98
Rochard abdominal retractor	298	Sponge holding forceps	241
Rochester-Carmalt artery forceps	131	Spoon orthopaedic	351
Rochester-Ochsner artery forceps	121	Spoon sharp	345, 349
Rochester-Pean artery forceps	124, 125, 441, 451	Stacke ear gouge	371
Roser-König mouth retractor	280	Stacke chisel guide	367
Roux retractor	275	Stacke sounds knife	38
Rumel dissecting forceps	134	Standard dressing forceps	88
Ruskin bone rongeurs	196, 200	Standard operating scissors	50, 51, 441, 451
Russ. Modell tissue forceps	96	Standard tissue forceps	88
Ryder/French-Eye needle holder	384	Standard trocar	417
S			
Sachs dura elevator	332	Stellbrink bone ronguers	195
Santulli atrauma bulldog clamp	149	Sterilization sleeve	442
Sanvenero dissecting scissors	58	Sternum needle holder	391
Sarot artery forceps	133	Stevens scissors micro super cut	75
Sarot needle holder	387	Stevens tenotomy scissors	66
Satinsky atrauma forceps	164	Stieglitz splinter forceps	98
Satinsky neurosurgical scissors	62	Stille chisel	368
Satinsky vena-cava forceps	187	Stille kidney pedicle clamp-forceps	139
Sauerbruch needle case	436	Stille plaster of paris shears	225
Sauerbruch raspatory	341	Stille scissors micro super cut	75
Sauerbruch rib forceps	204	Stille-Barraya tissue forceps	95
Sauerbruch-Frey forceps for ribs	205	Stille-Mayo scissors micro super cut	76
Saw blade for hard plaster	361	Stille-Rangell scissors micro super cut	76
Scalpel handle	27, 28	Stille-Ruskin bone ronguers	199
Segond myoma knife	36	Strabismus forceps	104
Semb dissecting forceps	138	Stripper	33, 34
Semb retractor	262	Strully neurosurgical scissors	61
Semken dissecting forceps	109	Strümpel ear polypus forceps	217
Semken dressing forceps	92	Subramanian atrauma forceps	186
Semken tissue forceps	92	Subramanian-miniature atrauma forceps	186
Semm abdominal retractor	295	Suction tube	419
Senn-Miller spinal hook	253	Suction tube Luer	420
Senning needle holder	385	Suction tube with olive Luer	420
Septum nasal elevator	333	Suction tube with regulation and olive	420, 421
Sequestrum forceps	227	Suture tying forceps	97
Set for medics	441	Suturing forceps	87, 105
Set for stool taking	445	Suturing needle	451
Set of blood and urine taking	445	Suturing veterinary set	451
Set of jaws for forceps Hercules	221	Swab wire	411
Set of rubber jaws for forceps Hercules	221	T	
Setting forceps for bulldog clamps	115	Tamponade applicator	33, 34
Seutin plaster-of-paris shears	72	Taylor bone elevator	332
Schaedel towel forceps	188	Taylor dressing forceps with dissector	93
Scherback vaginal speculum	315	Taylor neurological reflex hammer	21
Schink transplantation knife	44	Taylor tissue forceps with dissector	93
Schmieden-Payr ligature needle	400	Technical forceps	98
Schmieden-Taylor dura scissors	62	Test tube	446
Schmidt-Sawtell artery forceps	131	Test tube for analyzer	446
Schröder gynaecological forceps	237	Test tube for milk	445
Schwartz ear hook	272	Test tube for sputum	445
Schwartz paracentesis needle	37	Test tube for standardization	446
Schwartz tenotomy knife	37	Thiersch transplantation knife	44
Siebolt uterine scissors	53	Thorek dissecting scissors	56
Silver nasal plastic chisel	370	Tieck-Halle nasal speculum	318
Sims gynaecological scissors	53	Tissue forceps	88, 89, 91, 451
Sims rectal speculum	320	Toennis dissecting forceps	137
Sims uterine probe	409	Toennis dissecting scissors	61
Singley-Tuttle tissue forceps	96	Toennis-Adson-Delicate scissors delicate	84
Skull breaker	367	Tohoku-Japan towel forceps	189
		Tracheal hook	273

Tray	435
Troeltsch ear forceps	99
Troeltsch nasal forceps	99
Troeltsch sound hook	272
Troemner percussion hammer	22
Trochlearis retractor	252
Trousseau retractor	426
Tubing clamp	190
Tubing clamp with clip	190
Tubing forceps	190
Tuffier artery forceps	116
Tuffier kidney spatula	307
Tweezer quiver with stand	433

U

Ulrich polypus forceps	238
Unguent spatula	305
Universal bandage scissors	71
Universal wire shears	84
Urological dilator	425
Urological probe with olives	410
Uterine curette	355–357
Uterine probe	409
Uterine spoon	347

V

V. Petz stomach and intestinal suturing apparatus	402
Vaginal elevator	311, 312
Varices operation set	33
Varicose vein knife	35
Verbrugge reposition forceps	233
Verhoff capsule forceps	103
Virchow post mortem knife	42
Volkman retractor	254, 255
Volkman spoon	346

W

Wagner fine scissors	64
Waldmann episiotomy scissors	52
Walton retractor	286
Walton-Liston bone ronguers	203
Wangensteen dressing forceps	95
Wangensteen needle holder	387
Wangensteen tissue forceps	110
Weber atrauma forceps	167
Weber lid retractor	280
Weber wire loop	308
Webster needle holder	386
Weight only for Scherback speculum	315
Weitlaner retractor	281
Wertheim hysterectomy clamp-forceps	142, 143
Wertheim operating scissors	52
Wertheim-Cullen clamp-forceps	144
West nasal chisel	371
Westcott tenotomy scissors	68
Wigmore plaster-of-paris saw	361
Willet-Martel scalp flap forceps	116
Williger elevator	325
Williger raspatory	339
Winter abortion forceps	237
Wire cutting forceps	219, 220, 222
Wire forceps	219
Wire grasping forceps	226
Wire loop for microscopy	43
Wire loop for tonsil	358
Wolff plaster cast forceps	225
Wullstein retractor	282

Y





















Yankauer suction tube	422
Yasargil tumor forceps	97

Young retractor for prostate

270, 271

Z

Zahradníček elevator	325
Zaufal-Jansen bone ronguers	198
Zenker dissecting forceps	134
Zielke bone ronguers	210
Zielke laminectomy ronguers	210

	použit do	use by
	datum výroby	date of manufacture
	výrobce	manufacturer
	nepoužívat znovu	do not reuse
	neprovádět opětovnou sterilizaci	do not resterilize
	nepoužívat, jestliže je balení poškozeno	do not use if package is damaged
	otevřené balení nebude nahrazeno	opened packages are not replaced
	set, souprava	assortment
	pozor sledujte průvodní dokumentaci	caution, consult accompanying documents
	nesterilní	non sterile
	doporučené otáčky za minutu, doporučená frekvence otáčení XXX-XXX min ⁻¹	recommended rotation speed
	kód dávky	batch code
	katalogové číslo	catalogue number
	množství	quantity
	kontrola	control
	sterilní	sterile
	sterilizace ozářením	sterilization using irradiation
	sterilizace ethylenoxidem	sterilization using ethylene oxide
	sterilní zdravotnické prostředky zpracované aseptickou technologií	sterile by aseptic techniques
	diagnostický zdravotnický prostředek in vitro	in vitro diagnostic medical device
	globální nomenklatura zdravotnických prostředků	global medical device nomenclature code
	sledujte návod k použití	consult instructions for use

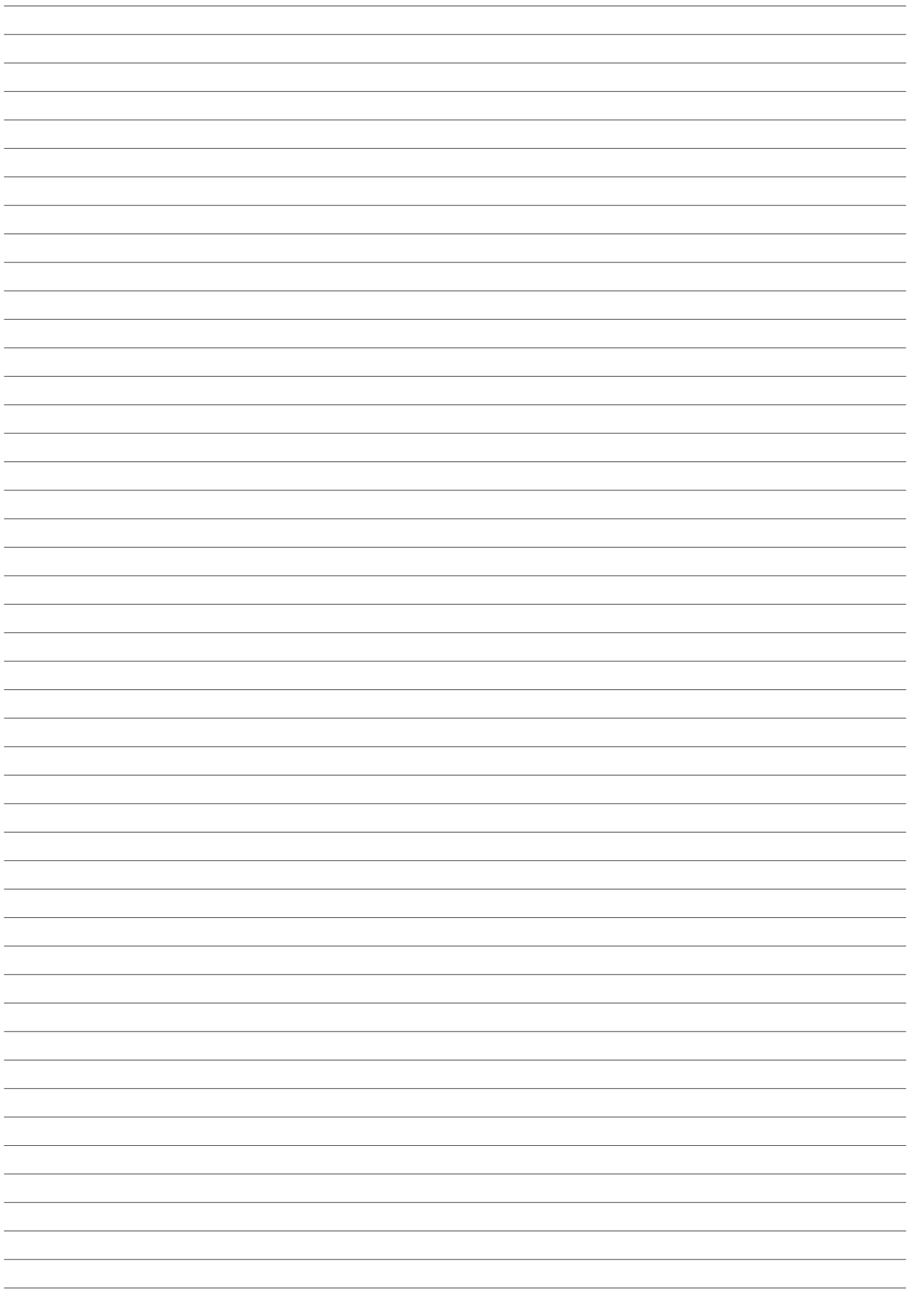

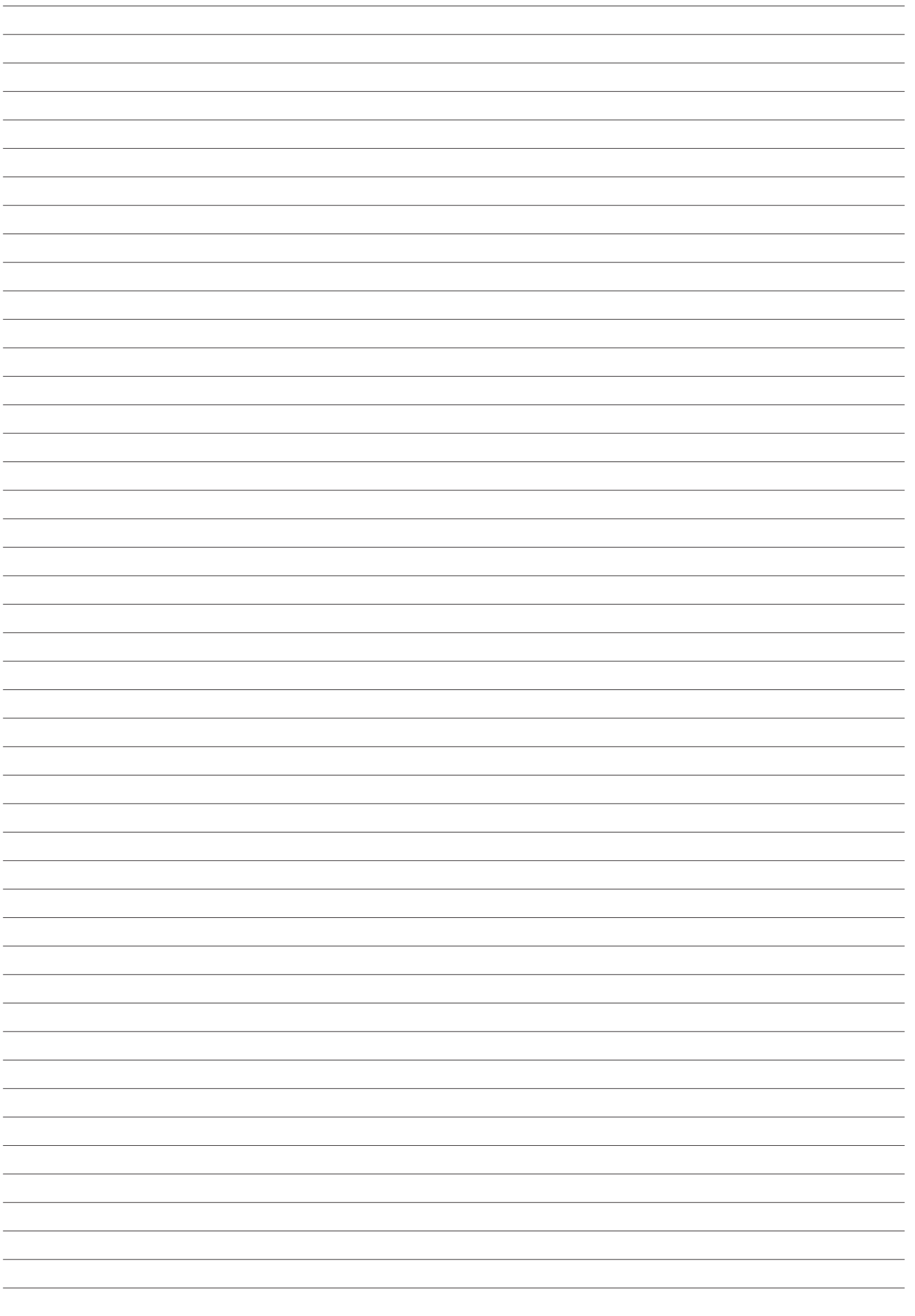

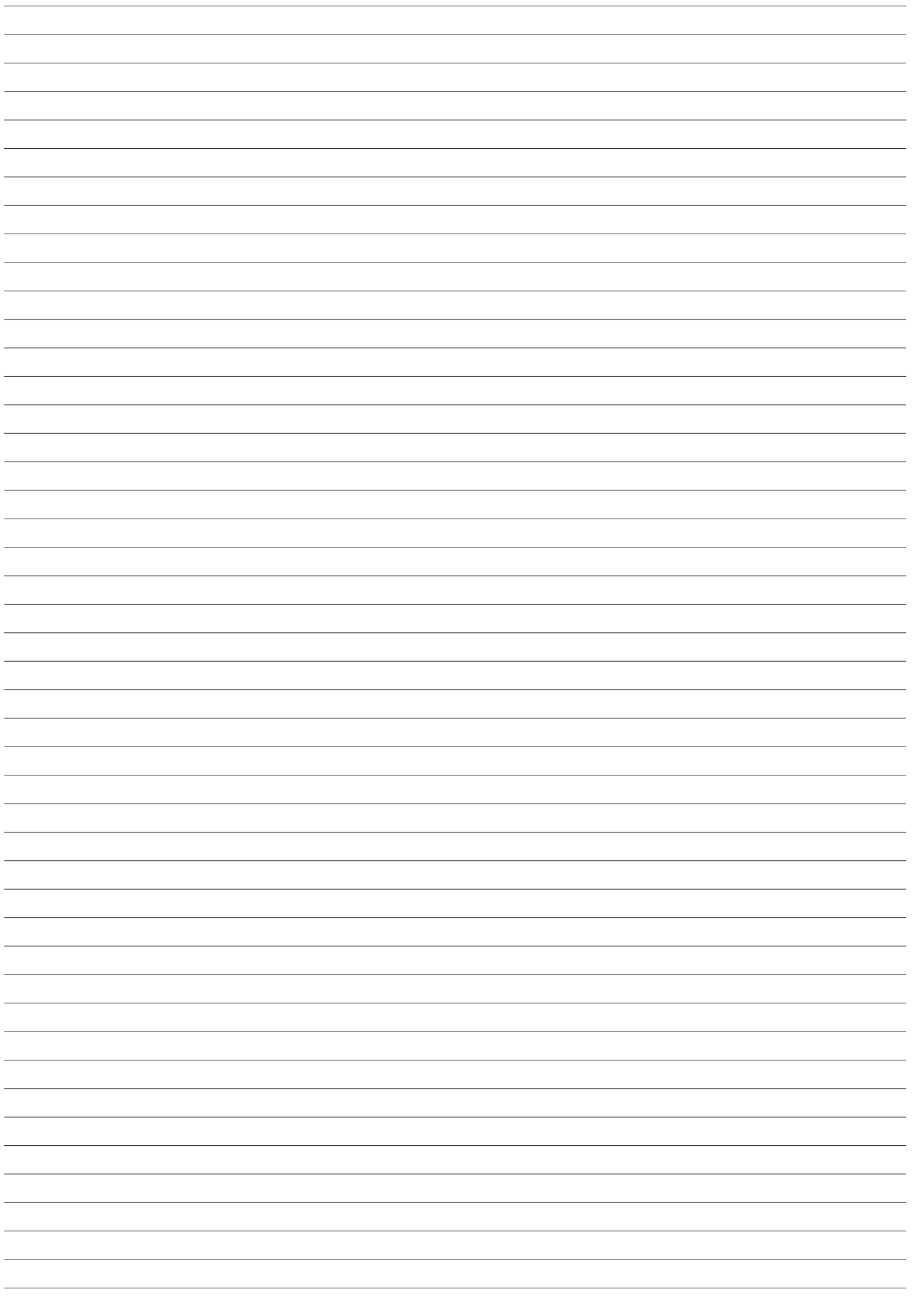

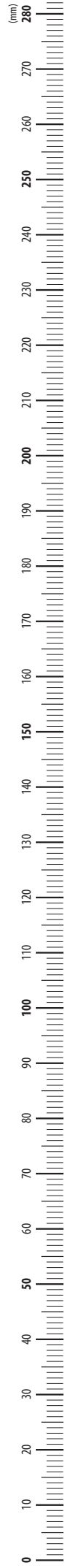
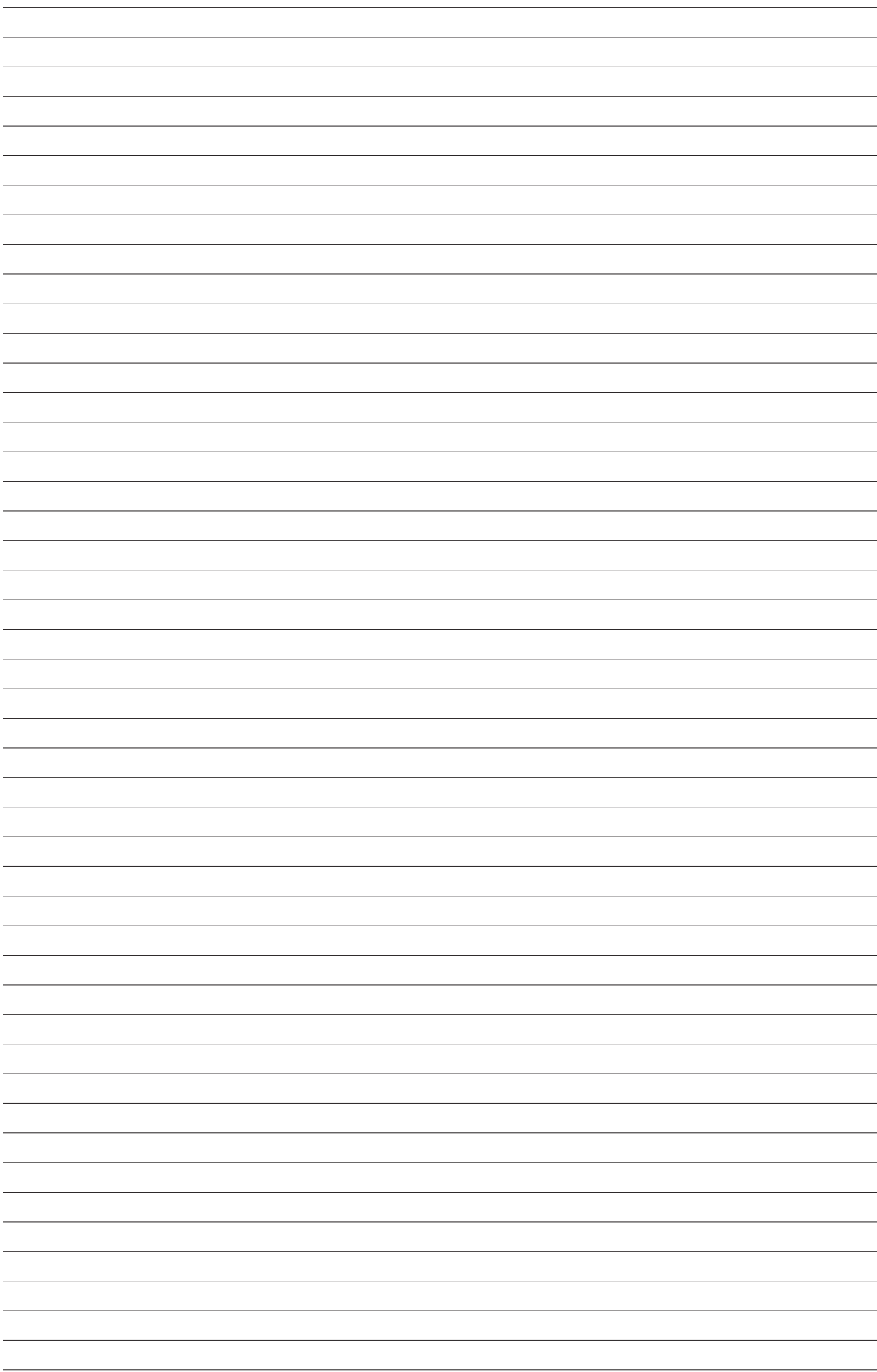

- ▶ CHIRURGIE / SURGERY
- ▶ TRAUMATOLOGIE / TRAUMATOLOGY
- ▶ ORTOPEDIE / ORTHOPAEDICS
- ▶ STOMATOLOGIE / DENTISTRY
- ▶ STERILIZACE / STERILIZATION
- ▶ LAPAROSKOPIE / LAPAROSCOPY
- ▶ ENDOSKOPIE / ENDOSCOPY
- ▶ ARTROSKOPIE / ARTHROSCOPY



kompletní nabídka lékařských nástrojů a implantátů na
full range of medical instruments and implants on

▶ www.medin.cz

© 2010 MEDIN, a.s.; Všechna práva vyhrazena.

Dokument je určen pro obchodní účely MEDIN, a.s., údaje zde uvedené jsou informativního charakteru.

Žádná část tohoto dokumentu nesmí být reprodukována nebo publikována v jakékoliv formě bez předchozího souhlasu MEDIN, a.s.

Zobrazení produktů odpovídá aktuálnímu stavu v době vydání tohoto dokumentu. Změny technických parametrů z důvodu dalšího vývoje jsou vyhrazeny.

Tiskové a typografické chyby jsou vyhrazeny.

© 2010 MEDIN, a.s.; All rights reserved.

This document should be used for commercial purposes of MEDIN, a.s.; the data mentioned in the document has informative character.

No part of this document can be copied or published in any form without approval of MEDIN, a.s.

The product design may differ from those depicted in these illustrations at the date of issue. Adjustments, made from the reason of further developments of technical parameters, are reserved.

Printing and typographical errors are reserved.

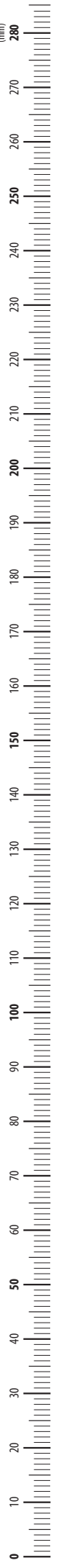

MEDIN, a.s.

Vlachovická 619
Nové Město na Moravě
CZ 592 31
Czech Republic
IČO 43378030
DIČ CZ43378030

CENTRÁLA

tel.: 566 684 111

PRODEJ ČESKÁ REPUBLIKA

tel.: 566 684 327
fax: 566 684 384
e-mail: prodej@medin.cz

PRODEJNA PRAHA

Jana Želivského 6
Praha 3
CZ 130 00
tel./fax: 222 592 334
mobil: 606 686 530

PRODEJ SLOVENSKÁ REPUBLIKA

tel.: +420 566 684 332
fax: +420 566 684 385
e-mail: export@medin.cz

EXPORT

phone: +420 566 684 336
fax: +420 566 684 385
e-mail: export@medin.cz

www.medin.cz

**NÁSTROJE PRO CHIRURGII
INSTRUMENTS FOR SURGERY**

2010

